

Wir behalten uns vor, Änderungen und Verbesserungen durchzuführen und die Instrumente und Geräte ohne besonderen Hinweis in der modifizierten Ausführung auszuliefern.

Die Verwendung dieses Kataloges zu anderen Zwecken als ausschließlich der zum Vertrieb von LAWTON-Produkten erforderlichen Handlungen, ist untersagt. Zuwiderhandlungen werden rechtlich geahndet. Der Nachdruck, auch auszugsweise, ist verboten.

We reserve the right of technical modifications and improvements and to supply the instruments and apparatus without specific indication in the modified finish. The use of this catalogue is restricted to actions necessary for selling original LAWTON products. The use for any purpose other than selling original LAWTON products is prohibited and will be prosecuted. Reprinting, even partially, is not allowed.

Nos reservamos el derecho de realizar modificaciones y mejoras y de entregar los instrumentos y los aparatos, sin avisar específicamente que se ha modificado la versión correspondiente.

Se prohíbe el uso de este prospecto para otras finalidades que las acciones exclusivamente necesarias para comercializar los productos de LAWTON. Se perseguirá jurídicamente a los infractores. Queda prohibida la reimpresión, incluso de partes del catálogo.

Nous nous réservons le droit d'effectuer des modifications et des améliorations et de livrer les instruments et appareils dans leur version modifiée sans mention spéciale.

L'utilisation de ce catalogue à d'autres fins que les seules opérations nécessaires à la vente des produits LAWTON est interdite. Toute infraction fera l'objet d'une poursuite en justice. La reproduction, même partielle, est interdite.

Ci riserviamo il diritto di apportare modifiche e migliorie nonché di fornire gli strumenti e gli apparecchi nella versione modificata senza particolare preavviso. Evietato l'utilizzo di questo catalogo informativo per qualsiasi altro scopo che esula dalle iniziative atte esclusivamente alla vendita dei prodotti LAWTON. Eventuali trasgressioni saranno perseguite per via legale. La riproduzione, anche parziale, di questo catalogo non è autorizzata.



LAWTON
Medizintechnik

LAWTON GmbH & Co. KG

Württembergischer Str. 23
D-78567 Fridingen
Germany

Postfach 45
D-78565 Fridingen
Germany

Telefon : (07463) 99 65-0
Telefax : (07463) 99 65-20
e-mail : info@lawton.de
Internet : <http://www.lawton.de>

Ausgabe / Edition / Edición / Edition / Edizione 2.2000

Seit 1947 werden in unserem Hause qualitativ hochwertige chirurgische Instrumente und medizintechnische Geräte hergestellt und vertrieben, die weltweit anerkannt und geschätzt werden.

Die Erfolge der Vergangenheit und besonders das Verantwortungsbewußtsein gegenüber dem Chirurgen und dem Patienten sind uns Verpflichtung, auch in Zukunft unsere ganze Kraft, Erfahrung und Kreativität zum Fortschritt der Medizintechnik einzusetzen.

Der vorliegende Chirurgie-Katalog Nr. 6/98 zeigt auf 758 Seiten mehr als 6.000 verschiedene Instrumente für die Medizintechnik. Er enthält von Seite 1 bis 380 das allgemeine Instrumentarium, das in allen chirurgischen Disziplinen erforderlich ist. Von der Seite 381 bis 730 finden Sie Instrumente für die verschiedenen Fachdisziplinen. An diese Seiten schließen sich die Bereiche Sterilisation und Reinigung an.

Der Katalog wird ergänzt durch zusätzliche Kataloge über MIC- (Minimal Invasive Chirurgie), HNO- (Hals / Nase / Ohr) und Ophthalmologie-Instrumente sowie durch Prospektunterlagen über Spezialitäten und Neuentwicklungen.

Since 1947, our company has been manufacturing and distributing high-quality surgical instruments and medical equipment that have gained a worldwide reputation for excellence.

We view our past success and, in particular, our responsibility towards the surgeon and the patient as an obligation to continue to focus our skill, experience, and creativity on advancing the art of medical technology in the future.

Containing 758 pages, our latest surgical catalogue, No. 6/98, describes more than 6,000 different instruments in the area of medical technology. Pages 1 to 380 cover the general instrumentation common for all surgical disciplines. Specialized instruments for particular areas of surgery can be found on pages 381 to 730. The final section of our catalogue covers the area of sterilization and cleaning.

Specialized catalogues for MIS (Minimal Invasive Surgery), ENT (Ear / Nose / Throat), and ophthalmological instruments, together with brochures covering special products and the latest developments, round out the offerings in our main catalogue.

Desde 1947 que fabricamos y comercializamos en nuestra empresa instrumentos quirúrgicos y aparatos de tecnología médica, los cuales están aceptados y son apreciados a nivel mundial.

Los éxitos del pasado, y especialmente la responsabilidad mostrada ante los cirujanos y los pacientes, nos compromete de forma que, también en el futuro, nos esforcemos para utilizar todos nuestros esfuerzos, experiencia y creatividad en el avance de la tecnología médica.

El presente catálogo n° 6/98, destinado a la cirugía, muestra en 758 páginas más de 6.000 diferentes instrumentos de tecnología médica. En las páginas 1 a 380 contiene el instrumentalario standard que es necesario en todas las disciplinas quirúrgicas. Desde la página 381 a la 730 se encuentran instrumentos para otras disciplinas médicas. Estas páginas van seguidas de los ámbitos de esterilización y de limpieza.

Este catálogo es completado por medio de catálogos adicionales acerca de instrumentos MIC (cirugía mínima invasiva), ORL (otorrinolaringología) y oftalmológicos, así como mediante prospectos sobre especialidades y nuevos desarrollos.

Depuis 1947, des instruments chirurgicaux et des appareils médicaux de très haute qualité reconnus et appréciés dans le monde entier sont produits et vendus au sein de notre société.

Les succès du passé et, notamment, la conscience de notre responsabilité à l'égard du chirurgien et du patient signifient pour nous le devoir de mettre en œuvre à l'avenir également toute notre force, notre expérience et notre créativité au service du progrès de la médecine.

Ce catalogue de produits chirurgicaux no. 6/98 montre sur 758 pages plus de 6.000 différents instruments destinés à la technique médicale. Il comporte aux pages 1 à 380 l'instrumentation générale nécessaire dans toutes les disciplines chirurgicales. A partir de la page 381 jusqu'à la page 730 se trouvent les instruments destinés aux différentes disciplines. A ces pages s'ajoutent enfin les domaines stérilisation et nettoyage.

Le catalogue est complété par des catalogues supplémentaires se rapportant aux instruments de la chirurgie invasive minimale, de l'oto-rhino-laryngologie et de l'ophtalmologie et par une documentation concernant les spécialités et les nouveaux développements.

Dal 1947 la nostra azienda produce e commercializza strumenti chirurgici ed apparecchi tecnico-medicali di alta qualità, rinomati ed apprezzati in tutto il mondo.

I successi conseguiti nel passato e, soprattutto, la consapevolezza della nostra responsabilità sono per noi motivo d'impegno affinché la nostra forza, la nostra esperienza e la nostra creatività possano anche in futuro essere al servizio del progresso del settore tecnico-medicale.

Il presente catalogo n. 6/98 dedicato alla chirurgia, presenta in oltre 758 pagine più di 6.000 diversi strumenti tecnico-medicali. Dalla pagina 1 alla pagina 380 è illustrata la strumentazione generica idonea per tutte le discipline chirurgiche. Da pagina 381 a pagina 730 troverete gli strumenti specifici per le singole discipline. In queste pagine trovano spazio gli strumenti di pulizia e sterilizzazione.

Il catalogo è integrato da ulteriori cataloghi illustranti gli strumenti specifici dei settori di chirurgia di minima invasiva, di otorinolaringoiatria e di oftalmologia, nonché da documentazione informativa dedicata alle varie specialità e alle novità.



Alles spricht über Qualität - LAWTON dokumentiert Qualität

LAWTON - where Certified Quality is at Home

Todos hablan de calidad - LAWTON documenta calidad

Tout le monde parle de la qualité - LAWTON la certifie

Tutti parlano di qualità - LAWTON documenta qualità

LAWTON
Medizintechnik

Mit der erfolgreich abgeschlossenen Überprüfung durch die DQS ist die Firma LAWTON nach DIN EN ISO 9001, DIN EN ISO 13485, EG-Richtlinie 93/42, Anhang 2 und 5 und damit nach den höchsten Nachweisstufen zertifiziert.

Die DIN EN ISO 9001 ist die Basisform für ein umfassendes Qualitätsmanagementsystem von der Produktidee bis zum Kundenservice. Diese Norm gilt für sämtliche Branchen, vom Maschinenbau bis zur Medizintechnik. Für die Medizintechnik gelten jedoch zusätzliche Anforderungen, welche in der DIN EN ISO 13485 festgeschrieben sind.

Die EG-Richtlinie 93/42, Anhang 2 und 5, sowie die nationalen Medizinprodukte-Gesetze beschreiben ein Qualitätsmanagement nach DIN EN ISO 13485. Zum Patientenschutz werden darin darüberhinaus Nachweise zur Eignung und Risikominimierung von Medizinprodukten gefordert.

Following successful conclusion of a review by DQS, LAWTON is now certified in conformity with DIN EN ISO 9001, DIN EN ISO 13485, EG guideline 93/42, annexes 2 and 5, and thus in accordance with the highest verification levels.

DIN EN ISO 9001 is the basic standard which governs a total quality management system from the product idea to after-sales service. This standard applies to all sectors, from mechanical to medical engineering. Additional requirements apply to medical engineering. These are laid down in DIN EN ISO 13485.

The EG guideline 93/42, annexes 2 and 5, and also the national medical products laws, describe quality management in conformity with DIN EN ISO 13485. To protect patients, proof of suitability and risk minimisation of medical products is also required.

Gracias a que el DQS ha terminado la comprobación del sistema de producción con éxito, la empresa LAWTON ya queda certificada con la presente según las normas DIN EN ISO 9001, DIN EN ISO 13485 y la directriz de la CE 93/42, anexos 2 y 5, es decir, al máximo nivel de certificación.

La norma DIN EN ISO 9001 es la norma básica para un amplio sistema de gestión de calidad, el cual abarca, desde la concepción de la idea del producto, hasta el servicio al cliente. Esta norma es válida para todos los sectores, desde la construcción de maquinaria, hasta la tecnología médica. De todas formas, para la tecnología médica son aplicables unos requisitos especiales, los cuales quedan determinados por la norma DIN EN ISO 13485.

La directriz de la CE 93/42, anexos 2 y 5, así como las leyes nacionales sobre productos medicinales, describen un sistema de gestión de calidad según la norma DIN EN ISO 13485. Para proteger a los pacientes, se requiere además la demostración de que los productos medicinales son idóneos y minimizan los riesgos correspondientes.

Avec la vérification couronnée de succès effectuée par le contrôle technique DQS, la Société LAWTON a été certifiée selon DIN EN ISO 9001, DIN EN ISO 13485, Directive CE 93/42, annexes 2 et 5, la plus haute justification possible.

La DIN EN ISO 9001 est la forme fondamentale pour un vaste système de gestion de la qualité, depuis l'idée du produit jusqu'au service clients. Cette norme est en vigueur pour toutes les branches, de la construction mécanique à la technique médicale. Cependant, pour la technique médicale, des exigences supplémentaires sont applicables et fixées dans la norme DIN EN ISO 13485.

La Directive CE 93/42, annexes 2 et 5, ainsi que les lois nationales relatives aux produits médicaux décrivent une gestion de la qualité selon DIN EN ISO 13485. Pour la protection des patients, des preuves de l'adéquation et de la minimisation des risques des produits médicaux y sont exigées.

In seguito all'esito positivo dato dalle prove eseguite dal DQS, la ditta LAWTON è certificata a norme DIN EN ISO 9001, DIN EN ISO 13485, direttiva CE 93/42, allegato 2 e 5 e può pertanto fregiarsi del massimo livello di certificazione qualitativa.

La certificazione DIN EN ISO 9001 fissa le regole del sistema di gestione della qualità nel suo complesso, dall'ideazione di un prodotto fino al servizio alla clientela. Questa norma è applicata in tutti i settori, dall'industria meccanica a quella tecnico-sanitaria. L'industria tecnico-sanitaria deve comunque rispondere ad ulteriori requisiti, quelli fissati dalla normative DIN EN ISO 13485.

La direttiva CE 93/42, allegato 2 e 5, e le leggi nazionali sui prodotti medicali esprimono una gestione della qualità ai sensi di DIN EN ISO 13485. In essa si richiedono ulteriori dimostrazioni dell'adeguatezza dei prodotti medicali e della minimizzazione dei rischi per la salvaguardia del paziente.



Ein hohes Entwicklungspotential und über 50 Jahre Erfahrung in der Medizintechnik haben LAWTON zu einem zuverlässigen Wegbegleiter der Medizin wachsen lassen.

A high development potential and more than 50 years of experience in medical engineering have made LAWTON a reliable partner in the medical sector.

El elevado potencial de desarrollo, así como la experiencia de más de 50 años en la tecnología médica, han convertido a LAWTON en un confiable compañero de la medicina.

Un fort potentiel de développement et plus de 50 ans d'expérience dans la technique médicale ont fait de LAWTON un compagnon fiable de la médecine.

Un alto potenziale di sviluppo e oltre 50 anni di esperienza nel settore tecnico-medico, hanno reso la LAWTON un partner sicuro ed affidabile della moderna medicina.



Das Fertigungs- und Lieferprogramm umfaßt derzeit über 12.000 verschiedene Produkte und wird heute über das weltweite LAWTON-Händlernetz vertrieben.

The production and delivery range currently embraces more than 12,000 different products and is today marketed through LAWTON's worldwide network of dealers.

El programa de producción y de suministro abarca actualmente más de 12.000 diferentes productos, siendo comercializados hoy en día a través de la red mundial de distribuidores de LAWTON.

Le programme de fabrication et de livraison comporte à l'heure actuelle plus de 12.000 différents produits; de nos jours, il est commercialisé dans le monde entier par le réseau de vendeurs de LAWTON.

La gamma di produzione e di distribuzione comprende attualmente oltre 12.000 diversi prodotti commercializzati attraverso la rete di vendita mondiale LAWTON.



Die permanente Verbesserung bestehender Produkte und die Entwicklung von Produktinnovationen sowie der Einsatz neuester Werkstoffe sichern die Wettbewerbsfähigkeit von LAWTON.

LAWTON's competitiveness is safeguarded by the permanent enhancement of existing products and the development of product innovations as well as use of the most modern materials.

La permanente mejora de los productos existentes y el desarrollo de productos innovativos, así como el uso de materiales totalmente nuevos, nos permite asegurar la competitividad de LAWTON.

L'amélioration permanente des produits existants, la mise au point d'innovations ainsi que la mise en œuvre des matériaux les plus modernes garantissent la compétitivité des produits LAWTON.

Il costante miglioramento dei prodotti già esistenti e la realizzazione di prodotti innovativi nonché l'impiego di nuovi materiali, confermano l'alto livello di competitività della LAWTON.



Die hohen Anforderungen der Norm DIN EN ISO 9001 mit dem Medizialzusatz DIN EN ISO 13485 gewährleisten den hochwertigen Qualitätsstandard und die Modelltreue aller LAWTON-Instrumente.

The high requirements of the DIN EN ISO 9001 requirement in conjunction with the additional medical standard DIN EN ISO 13485 guarantee the high quality standard and model fidelity of all LAWTON instruments.

Los elevados requisitos derivados de la norma DIN EN ISO 9001, junto al complemento médico de la norma DIN EN ISO 13485, garantizan el elevado nivel de calidad y la fidelidad de los modelos de instrumentos de LAWTON.

Les hautes exigences imposées par la norme DIN EN ISO 9001 avec son complément médical DIN EN ISO 13485 garantissent le haut standard de qualité et la fidélité des modèles de tous les instruments LAWTON.

I severi requisiti imposti dalla norma DIN EN ISO 9001 insieme alla norma DIN EN ISO 13485 specifica per il settore medicale, garantiscono l'alta qualità e la conformità di tutti gli strumenti LAWTON.



Die moderne Produktionsstätte von LAWTON befindet sich nur wenige Kilometer von Tuttlingen entfernt, das weltweit bekannt ist als Zentrum der Herstellung chirurgischer Instrumente.

LAWTON's modern production facility is located only a few kilometres away from Tuttlingen, which is known throughout the world as a centre for the production of surgical instruments.

El moderno lugar de producción de LAWTON se encuentra ubicado sólo a unos pocos kilómetros de Tuttlingen, la cual es conocida en todo el mundo como centro de fabricación de instrumentos quirúrgicos.

Le site moderne de production de LAWTON ne se trouve qu'à quelques kilomètres de Tuttlingen, mondialement connu comme le centre de la fabrication d'instruments chirurgicaux.

I moderni stabilimenti di produzione della LAWTON si trovano solo a pochi chilometri da Tuttlingen, il centro di produzione di strumenti chirurgici famoso in tutto il mondo.



Die sorgfältige Auswahl von qualitativ hochwertigen Roh-, Hilfs- und Betriebsstoffen schaffen die Basis für das hohe Qualitätsniveau aller LAWTON-Instrumente.

Careful selection of high-grade raw materials and consumables creates the basis for the high quality level of all LAWTON instruments.

La cuidadosa selección de materias primas, materiales adicionales y medios de producción de alta calidad crea la base para el elevado nivel de calidad de los instrumentos de LAWTON.

Le choix méticuleux des matériaux bruts, auxiliaires et des produits d'exploitation de haute qualité sont la base du haut niveau de qualité de tous les instruments LAWTON.

L'attenta selezione di materiali grezzi, ausiliari e d'esercizio di alta qualità sta alla base dell'alto standard qualitativo di tutti gli strumenti LAWTON.



Moderne, CNC-gesteuerte Bearbeitungszentren und neu entwickelte Fertigungsverfahren garantieren von der maschinellen Vorfertigung bis zur Endkontrolle des fertigen Produkts für hohe Qualität und Funktionalität der LAWTON-Instrumente.

From machine preproduction to final inspection of the finished product, modern CNC-controlled machining centres and newly developed production processes are guarantors of the high quality and functionality of LAWTON instruments.

Modernos centros de elaboración controlados por CNC y procesos de producción de nuevo desarrollo garantizan, desde la preproducción maquina, hasta llegar al control final del producto acabado, la elevada calidad y funcionalidad de los instrumentos de LAWTON

Les centres d'usinage modernes à commande CNC et des processus de fabrication nouvellement développés sont la garantie de la haute qualité et fonctionnalité des instruments LAWTON depuis la préfabrication mécanique jusqu'au contrôle final du produit fini.

Moderni centri di lavorazione a controllo numerico computerizzato e processi produttivi altamente innovativi, dalla prelaborazione in macchina fino al collaudo finale dei prodotti finiti, sono garanzia di qualità e funzionalità degli strumenti LAWTON.

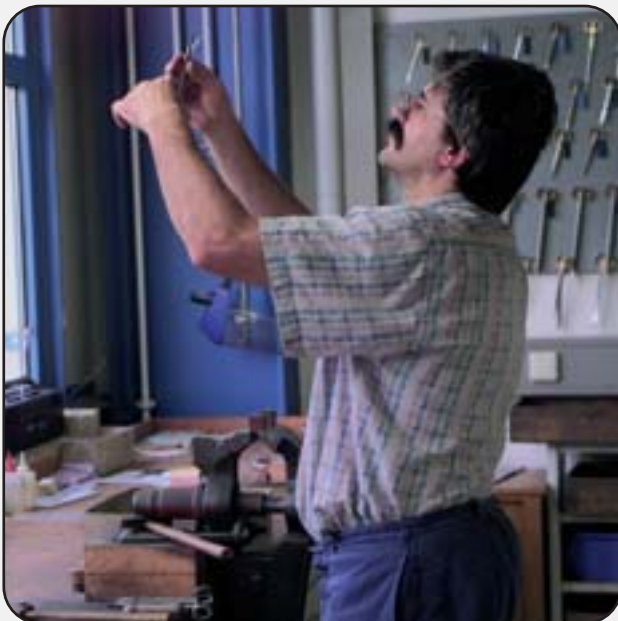

Das handwerkliche Geschick und das geschulte Auge des Chirurghiemechanikers sichern die einwandfreie Funktion und Zuverlässigkeit aller LAWTON-Instrumente.

The craftsman's skills and the trained eye of the surgical mechanic ensure perfect functioning and reliability of all LAWTON instruments.

La pericia manual y la vista experta de los mecánicos quirúrgicos asegura que los instrumentos de LAWTON funcionen a la perfección y sean confiables.

L'adresse artisanale et l'œil exercé du mécanicien chirurgical garantissent la fonction parfaite et la fiabilité de tous les instruments LAWTON.

L'abilità artigianale e l'occhio esperto del meccanico del settore chirurgico assicurano la massima funzionalità e affidabilità di tutti gli strumenti LAWTON.



Ständige Kontrollen während der Fertigung und am Ende des Produktionsprozesses gewährleisten Zuverlässigkeit und Funktionalität über die gesamte Lebensdauer aller LAWTON-Instrumente.

Constant inspections during production and at the end of the production process guarantee reliability and functionality throughout the entire service life of all LAWTON instruments.

Constantes controles durante la producción y al final del proceso de fabricación garantizan que los instrumentos de LAWTON sean confiables y funcionen durante toda su vida útil.

Des contrôles permanents en cours de fabrication et à la fin du processus de production garantissent la fiabilité et la fonctionnalité pour l'ensemble de la durée de vie utile de tous les instruments LAWTON.

Controlli ripetuti e costanti in fase di produzione e al termine del processo produttivo garantiscono massima affidabilità e funzionalità durante l'intera vita operativa di tutti gli strumenti LAWTON.



Die Abteilung „Technischer Kundenservice“ führt innerhalb einer Woche Reparaturen von Instrumenten aller Art - mit einem geringen Kostenaufwand - durch.

The „Technical After-Sales Service“ department repairs all manner of instruments within one week and at low cost.

El departamento de „Servicio técnico al cliente“ realiza, en el plazo de una semana - reparaciones de instrumentos de todo tipo - a bajo costo.

Le département „Service technique après-vente“ effectue en une semaine - à peu de frais - les réparations des instruments de toute nature.

Il reparto „Assistenza Tecnica alla Clientela“ esegue nell'arco di una settimana - a costi contenuti - la riparazione di strumenti di tutti i generi.

Informationen

Informations
Informaciones
Informations
Informazioni

LAWTON
Medizintechnik



Das gut sortierte Instrumentenlager sowie eine mit modernster Daten- und Informationstechnik gesteuerte Produktionsplanung, Disposition und Lagerlogistik bieten unseren Kunden schnelle und zuverlässige Informationen und eine optimale Lieferbereitschaft. In der Regel sind alle Standard-Instrumente ab Lager lieferbar.

The well-appointed instruments warehouse and production planning, control, dispatching and warehouse logistics controlled by the most up-to-date data processing and information systems offer our customers fast and reliable information and optimum delivery readiness. All standard instruments are generally available from stocks.

El almacén de instrumentos bien surtido, así como la moderna tecnología de procesamiento de datos e informática aplicada a la planificación y al control de la producción, la disposición y la logística de almacenamiento, ofrece a nuestros clientes informaciones rápidas y confiables, así como una óptima disponibilidad de entrega. Normalmente, todos los instrumentos standards, están disponibles del stock.

Le stock d'instruments bien assorti et une planification et gestion des produits, la disposition et la logistique des stocks, commandées par une technique d'information et de communication les plus modernes, offrent à nos clients des informations rapides et fiables et une capacité de livraison optimale. En règle générale, tous les instruments standards sont disponibles en stock.

Un magazzino ben organizzato e una pianificazione, gestione, disposizione della produzione e una logistica di stoccaggio gestiti con le più moderne tecniche informatiche assicurano alla nostra clientela un veloce ed affidabile scambio di informazioni e un'ottimale disponibilità alla fornitura. Di regola, tutti gli strumenti standard sono disponibili a magazzino.



Alle von LAWTON hergestellten und vertriebenen Instrumente tragen das LAWTON-LOGO und die individuelle Artikelnummer sowie das europäische CE-Zeichen.

All instruments manufactured and sold by LAWTON bear the LAWTON logo and their individual article numbers as well as the European CE mark.

Todos los instrumentos fabricados y comercializados por LAWTON llevan el logotipo de LAWTON y el número del artículo correspondiente, así como la marca CE europea.

Tous les instruments produits et vendus par LAWTON portent les logo LAWTON, le numéro individuel d'article et la marque CE européenne.

Su tutti gli strumenti prodotti e commercializzati da LAWTON è riportato il logo LAWTON con il rispettivo codice articolo e il marchio europeo CE.



Moderne Kommunikations- und Informationstechnik unterstützen unsere Mitarbeiter in ihren Bemühungen, unseren Kunden in aller Welt einen optimalen After-Sales-Service zu gewähren.

Modern communication and information technology support our staff in their endeavours to provide optimum after-sales service to our customers throughout the world.

Nuestros empleados son apoyados en sus esfuerzos, con moderna tecnología de comunicaciones e informática, que garantiza un servicio postventa óptimo a nuestra clientela en el mundo entero.

La technique moderne de communication et d'information assiste nos collaborateurs dans leurs efforts consacrés à garantir un service après-vente optimal dans le monde entier.

I nostri collaboratori si avvalgono delle più moderne tecniche informatiche e di comunicazione per poter garantire alla clientela di tutto il mondo un servizio di assistenza post-vendita ottimale.



In unserem Ausstellungszentrum sowie auf den wichtigsten nationalen und internationalen Fachmessen zeigt LAWTON Neuheiten und ihr bewährtes Lieferprogramm für alle Bereiche der modernen Medizin.

In our exhibition centre, and at the most important national and international trade fairs, LAWTON presents new products and its proven delivery range for all areas in modern medicine.

LAWTON muestra las novedades y el programa de suministro para todas las disciplinas de la medicina moderna, en nuestro centro de exposición, así como en las ferias especializadas nacionales e internacionales más importantes.

Dans notre centre d'exposition et les salons nationaux et internationaux les plus importants, LAWTON montre des nouveautés et son programme de livraison éprouvé pour toutes les disciplines de la médecine moderne.

Nel nostro centro espositivo e presso le più importanti fiere nazionali e internazionali specifiche del settore, la LAWTON mostra le sue novità e la sua gamma di prodotti per tutti i settori della moderna medicina.

Informationen

Informations
Informaciones
Informations
Informazioni

LAWTON
Medizintechnik

Instrumente mit Hartmetallschneiden

Instruments with tungsten carbide edges
Instrumentos con filos de carburo tungsteno
Instruments avec des lames en tungstène
Strumenti con lame in carburo di tungsteno

DURACUT®

Instrumente mit Hartmetalleinlagen

Instruments with tungsten carbide inserts
Instrumentos con bocas de carburo tungsteno
Instruments avec mors en tungstène
Strumenti con morsi in carburo di tungsteno

TITE GRIP®

Instrumente mit spezialbeschichteten Maulteilen

Instruments with specially coated jaws
Instrumentos con bocas cubiertas especiales
Instruments avec mors recouverts d'une couche spéciale
Strumenti con copertura speciale della punta

PERFECT-GRIP

Instrumente mit atraumatischer Riefung

Instruments with non-traumatic serration
Instrumentos con bocas atraumáticas
Instruments avec mors atraumatiques
Strumenti con presa atraumatica

ATRAUMATIC-GRIP

Instrumente aus TITAN

Instruments made from TITANIUM
Instrumentos de TITANIO
Instruments en TITANE
Strumenti in TITANIO

TITAN-LINE

Flüssiges Konzentrat zur Pflege chirurgischer Instrumente

Liquid concentrate for surgical instrument care
Líquido concentrado para el cuidado de instrumental quirúrgico
Concentré liquide pour l'entretien des instruments
Concentrato liquido per la cura degli strumenti chirurgici

PREP LUBE



| | | |
|-------------------------|--------------|---------------|
| Diagnostik | Seite | 1 - 14 |
| Diagnosics | Page | 1 - 14 |
| Diagnóstico | Página | 1 - 14 |
| Diagnostic | Page | 1 - 14 |
| Diagnostica | Pagina | 1 - 14 |



| | | |
|---|--------------|----------------|
| Vorbereitung, Dermatologie | Seite | 15 - 20 |
| Preparation, Dermatology | Page | 15 - 20 |
| Preparación, Dermatología | Página | 15 - 20 |
| Préparation, Dermatologie | Page | 15 - 20 |
| Preparazione, Dermatologia | Pagina | 15 - 20 |



| | | |
|----------------------|--------------|----------------|
| Narkose | Seite | 21 - 32 |
| Anaesthesia | Page | 21 - 32 |
| Anestesia | Página | 21 - 32 |
| Anesthésie | Page | 21 - 32 |
| Anestesia | Pagina | 21 - 32 |



| | | |
|--------------------------------|--------------|----------------|
| Skalpelle, Messer | Seite | 33 - 42 |
| Scalpels, Knives | Page | 33 - 42 |
| Bisturíes, Cuchillos | Página | 33 - 42 |
| Bistouris, Couteaux | Page | 33 - 42 |
| Bisturi, Coltelli | Pagina | 33 - 42 |



| | | |
|---|--------------|----------------|
| DURACUT® Scheren mit Hartmetallschneiden | Seite | 43 - 60 |
| DURACUT® Scissors with tungsten carbide edges | Page | 43 - 60 |
| DURACUT® Tijeras con filos de carburo tungsteno | Página | 43 - 60 |
| DURACUT® Ciseaux avec des lames en tungstène | Page | 43 - 60 |
| DURACUT® Forbici con lame in carburo di tungsteno | Pagina | 43 - 60 |

Inhaltsübersicht

Table of Contents

Sumario

Table de matières

Indice

LAWTON
Medizintechnik

| | | |
|----------------------|--------------|-----------------|
| Scheren | Seite | 61 - 110 |
| Scissors | Page | 61 - 110 |
| Tijeras | Página | 61 - 110 |
| Ciseaux | Page | 61 - 110 |
| Forbici | Pagina | 61 - 110 |



| | | |
|--|--------------|------------------|
| TITE GRIP® Pinzetten mit Hartmetalleinlagen | Seite | 111 - 118 |
| TITE GRIP® Forceps with tungsten carbide inserts | Page | 111 - 118 |
| TITE GRIP® Pinzas con bocas de carburo tungsteno | Página | 111 - 118 |
| TITE GRIP® Pincers avec mors en tungstène | Page | 111 - 118 |
| TITE GRIP® Pinze con morsi in carburo di tungsteno | Pagina | 111 - 118 |



| | | |
|------------------------|--------------|------------------|
| Pinzetten | Seite | 119 - 152 |
| Forceps | Page | 119 - 152 |
| Pinzas | Página | 119 - 152 |
| Pincers | Page | 119 - 152 |
| Pinze | Pagina | 119 - 152 |



| | | |
|-----------------------------------|--------------|------------------|
| Klemmen, Klemmzangen | Seite | 153 - 198 |
| Forceps, Clamps Forceps | Page | 153 - 198 |
| Pinzas, Pinzas-clamps | Página | 153 - 198 |
| Pincers, Pincers-clamps | Page | 153 - 198 |
| Pinze, Pinze emostatiche | Pagina | 153 - 198 |

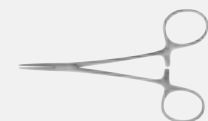

| | | |
|---|--------------|------------------|
| Tuchklemmen, Schlauchklemmen, Tupferzangen | Seite | 199 - 210 |
| Towel Clamps, Tubing Clamps, Cotton Swab Forceps | Page | 199 - 210 |
| Pinzas de campo, Pinzas para tubos, Pinzas para tampones | Página | 199 - 210 |
| Pincers à compresses, Pincers presse-tubes, Pincers à tampons | Page | 199 - 210 |
| Pinze per fissare le compresse, Pinze per tubi, Pinze per tamponi | Página | 199 - 210 |





| | | |
|------------------------|--------------|------------------|
| Wundhaken | Seite | 211 - 268 |
| Retractors | Page | 211 - 268 |
| Separadores | Página | 211 - 268 |
| Ecarteurs | Page | 211 - 268 |
| Divaricatori | Pagina | 211 - 268 |



| | | |
|--|--------------|------------------|
| Wundspreizer (selbsthaltend), Bauchdeckenhalter | Seite | 269 - 310 |
| Self-Retaining Retractors, Abdominal Retractors | Page | 269 - 310 |
| Separadores con retenida automática, Separadores abdominales | Página | 269 - 310 |
| Ecarteurs autostatiques, Ecarteurs abdominaux | Page | 269 - 310 |
| Divaricatori autostatici, Divaricatori addominali | Pagina | 269 - 310 |



| | | |
|--|--------------|------------------|
| Sonden, Trokare, Saugrohre, Spritzen | Seite | 311 - 334 |
| Probes, Trocars, Suction Tubes, Syringes | Page | 311 - 334 |
| Sondas, Trócares, Tubos de aspiración, Jeringas | Página | 311 - 334 |
| Sondes, Trocars, Canules d'aspiration, Seringues | Page | 311 - 334 |
| Sonde, Tre quarti, Tubi aspirazione, Siringhe | Pagina | 311 - 334 |

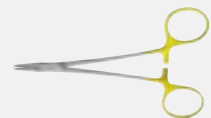

| | | |
|---|--------------|------------------|
| TITE GRIP® Nadelhalter mit Hartmetalleinlagen | Seite | 335 - 350 |
| TITE GRIP® Needle Holders with tungsten carbide inserts | Page | 335 - 350 |
| TITE GRIP® Porta-agujas con bocas de carburo tungsteno | Página | 335 - 350 |
| TITE GRIP® Porte-aiguilles avec mors en tungstène | Page | 335 - 350 |
| TITE GRIP® Portaghi con morsi in carburo di tungsteno | Pagina | 335 - 350 |

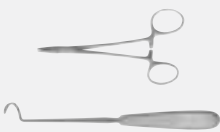

| | | |
|--------------------------------|--------------|------------------|
| Nahtinstrumente | Seite | 351 - 380 |
| Suture Instruments | Page | 351 - 380 |
| Instrumentos para sutura | Página | 351 - 380 |
| Instrumenti à suture | Page | 351 - 380 |
| Strumenti per sutura | Pagina | 351 - 380 |

Inhaltsübersicht

Table of Contents

Sumario

Table de matières

Indice

LAWTON
Medizintechnik

| | | |
|------------------------------------|--------------|------------------|
| Darm, Magen, Mastdarm | Seite | 381 - 412 |
| Intestines, Stomach, Rectum | Page | 381 - 412 |
| Intestino, Estómago, Recto | Página | 381 - 412 |
| Intestins, Estomac, Rectum | Page | 381 - 412 |
| Intestino, Stomaco, Retto | Pagina | 381 - 412 |



| | | |
|---|--------------|------------------|
| Galle, Leber, Niere, Blase, Urologie | Seite | 413 - 426 |
| Gall, Liver, Kidney, Bladder, Urology | Page | 413 - 426 |
| Bilis, Hígado, Riñón, Vejiga, Urología | Página | 413 - 426 |
| Bile, Foie, Rein, Vessie, Urologie | Page | 413 - 426 |
| Bile, Fegato, Rene, Vescica, Urologia | Pagina | 413 - 426 |



| | | |
|--------------------------|--------------|------------------|
| Gynäkologie | Seite | 427 - 474 |
| Gynecology | Page | 427 - 474 |
| Ginecología | Página | 427 - 474 |
| Gynécologie | Page | 427 - 474 |
| Ginecologia | Pagina | 427 - 474 |



| | | |
|---------------------------|--------------|------------------|
| Geburtshilfe | Seite | 475 - 486 |
| Obstetrics | Page | 475 - 486 |
| Obstetricia | Página | 475 - 486 |
| Obstétrique | Page | 475 - 486 |
| Ostetricia | Pagina | 475 - 486 |



| | | |
|--|--------------|------------------|
| Thorax- und Gefäßchirurgie | Seite | 487 - 566 |
| Thoracic and Vascular Surgery | Page | 487 - 566 |
| Cirugía torácica y vascular | Página | 487 - 566 |
| Chirurgie thoracique et vasculaire | Page | 487 - 566 |
| Chirurgia toracica e vascolare | Pagina | 487 - 566 |



InhaltsübersichtTable of Contents
Sumario
Table de matières
Indice

| | | |
|-------------------------------|--------------|------------------|
| Knochenchirurgie | Seite | 567 - 670 |
| Bone Surgery | Page | 567 - 670 |
| Cirugía ósea | Página | 567 - 670 |
| Chirurgie osseuse | Page | 567 - 670 |
| Chirurgia ossea | Pagina | 567 - 670 |



| | | |
|-------------------------------------|--------------|------------------|
| Verband und Gips | Seite | 671 - 682 |
| Dressing | Page | 671 - 682 |
| Vendajes | Página | 671 - 682 |
| Pansements, Appareils plâtrés | Page | 671 - 682 |
| Bendaggi, Gessature | Pagina | 671 - 682 |



| | | |
|--|--------------|------------------|
| Neurochirurgie und Laminektomie | Seite | 683 - 722 |
| Neurosurgery and Laminectomy | Page | 683 - 722 |
| Neurocirugía y Laminectomía | Página | 683 - 722 |
| Neurochirurgie et Laminectomie | Page | 683 - 722 |
| Neurochirurgia e Laminectomia | Pagina | 683 - 722 |



| | | |
|---------------------------|--------------|------------------|
| Tracheotomie | Seite | 723 - 730 |
| Tracheotomy | Page | 723 - 730 |
| Traqueotomía | Página | 723 - 730 |
| Trachéotomie | Page | 723 - 730 |
| Tracheotomia | Pagina | 723 - 730 |



| | | |
|---|--------------|------------------|
| Sterilisation, Verschiedenes | Seite | 731 - 758 |
| Sterilization, Miscellaneous | Page | 731 - 758 |
| Esterilización, Diversos artículos | Página | 731 - 758 |
| Stérilisation, Divers articles | Page | 731 - 758 |
| Sterilizzazione, Diversi articoli | Pagina | 731 - 758 |



LAWNTON

Medizintechnik



Diagnostik
Diagnostics
Diagnóstico
Diagnostic
Diagnostica



Perkussions- und Reflexhämmer
Percussion Hammers
Martillos de percusión y para reflejos
Marteaux à percussion et à réflexe
Martelli percussori



1/2

TAYLOR
18-0110 18 cm, 7"
▶ 18-0115 20 cm, 8"



1/2

BERLINER
18-0117
20 cm, 8"



1/2

DEJERINE
18-0103
20 cm, 8"



1/2

DEJERINE
18-0104
21,5 cm, 8 1/2"

mit Nadel
with needle
con aguja
avec aiguille
con ago



BUCK
 18-0105
 18 cm, 7"

Hammer für neurologische Untersuchungen, mit Pinsel und Nadel

Hammer for neurological examinations, with brush and needle

Martillo para exámenes neurológicos, con cepillo y aguja

Marteau avec brosse et aiguille pour examens neurologiques

Martello neurologico, con ago e pennello



RABINER
 18-0100
 23,5 cm, 9 1/4"

Hammer für neurologische Untersuchungen, mit Pinsel und Nadel

Hammer for neurological examinations, with brush and needle

Martillo para exámenes neurológicos, con cepillo y aguja

Marteau avec brosse et aiguille pour examens neurologiques

Martello neurologico, con ago e pennello



TROEMNER
 18-0106
 23 cm, 9"



Sensibilitätsinstrumente
Sensibility Instruments
Instrumentos para examinar la sensibilidad
Instruments pour mesurer la sensibilité
Strumenti per misurare la sensibilità

Stimmgabeln
Tuning Forks
Diapasónes
Diapasons
Diapason



WEBER
18-0134
9,5 cm, 3³/₄"
Ästhesiometer
Aesthesiometer
Estesiometro
Aesthésiomètre
Estensiometro

1/2



ALY
18-0132
17,5 cm, 7"
Algesimeter (Nadel und Pinsel)
Algesimeter (needle and brush)
Algesímetro (aguja y cepillo)
Algesimètre (aiguille et brosse)
Algesiometro (ago e pennello)

1/2



WARTENBERG
18-0130
19 cm, 7 1/2"
Algesimeter (Nervrädchen)
Algesimeter (pinwheel)
Algesímetro (rueda con espinas)
Algesimètre (roue roue aiguillée pour nerfs)
Algesiometro (rotella neurologica)

1/2



HARTMANN
65-0281 c 128
65-0282 c¹ 256
▶ 65-0273 c² 512
65-0274 c³ 1024
Stimmgabeln
Tuning forks
Diapasónes
Diapason
Diapason

1/2



65-0285
a¹ 440
Stimmgabel
Tuning fork
Diapasón
Diapason
Diapason

1/2



verschiebbar
bis h
variable up to h
(engl. b)
variable hasta h
variable jusqu'à h
variabile fino a h

LUCAE
65-0234
c 128
Stimmgabel für Neurologie
Tuning fork for neurology
Diapasón para neurologia
Diapason pour neurologie
Diapason per neurologia

1/2

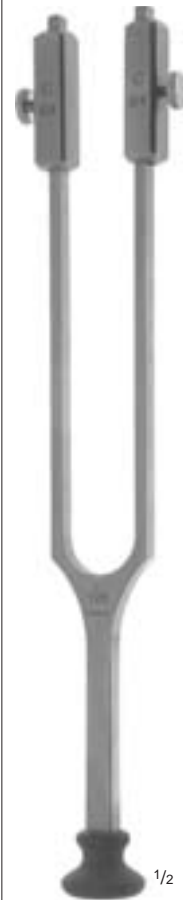

mit Dämpfer c 64
ohne Dämpfer c 128
with clamps c 64
without clamp c 128
con sordinas c 64
sin sordinas c 128
avec curseurs c 64
sans curseurs c 128
con cursori c 64
senza cursori c 128

RYDEL-SEIFFER
65-0230
c 64 / c 128
Stimmgabel für Neurologie
Tuning fork for neurology
Diapasón para neurologia
Diapason pour neurologie
Diapason per neurologia

1/2



WINTER
 18-0191
 13,5 cm, 5 1/4"
 Stethoskop aus Holz, zur Wahrnehmung
 fötaler Herztöne
 Stethoscope of wood, for fetal heart sounds
 Estetoscopio de madera, para tonos cardíacos
 fetal
 Stéthoscope en bois, pour examen foetal
 Stetoscopio per toni cardiaci fetali, in legno



PINARD
 18-0190
 15 cm, 6"
 Stethoskop aus Aluminium, zur Wahrnehmung
 fötaler Herztöne
 Stethoscope of aluminium, for fetal heart sounds
 Estetoscopio de aluminio, para tonos cardíacos
 fetal
 Stéthoscope en aluminium, pour examen foetal
 Stetoscopio per toni cardiaci fetali, in alluminio



SUPER
 18-0170
 Kombinations-Stethoskop aus Leichtmetall, mit drehbarem Membran- (ø 48 mm) und Trichter-
 Bruststück (ø 33 mm)
 Stethoscope combination of light metal, with turnable diaphragm- (ø 48 mm) and bell type chest
 piece (ø 33 mm)
 Estetoscopio combinado de metal ligero, con diafragma girable (ø 48 mm) y parte pectoral con
 forma de campana (ø 33 mm)
 Stéthoscope combiné en métal léger, avec membrane rotative (ø 48 mm) et pavillon entonnoir
 (ø 33 mm)
 Combinazione stetoscopica in metallo leggero con parte pettorale (ø 33 mm) a diaframma (ø 48
 mm) girevole



Prüf- und Meßinstrumente
 Examination and Measuring Instruments
 Instrumentos para exámenes y medición
 Instruments pour examiner et mesurer
 Strumenti per esaminare e misurare



1/2

COLLIN
 18-0150
 12,5 cm, 5"

Dynamometer für Erwachsene, Druck 70 kg
 Dynamometer for adults, pressure 70 kg
 Dinamómetro para adultos, presión 70 kg
 Dynamomètre pour adultes, pression 70 kg
 Dinamometro per adulti, pressione 70 kg



1/4

18-0155
 260 x 105 x 125 mm

Kraftmesser komplett in Plastik-Kassette, bestehend aus 3 Gummibällen (klein, mittel, groß) mit Konusansätzen, Schlauch mit Steckkonus und Meßuhr.

Dynamometer complete in plastic case, consisting of 3 rubber bulbs (small, medium, large), with cone adaptors, tubing with metal mount and manometer.

Dinamómetro completo en estuche de plástico, compuesto de 3 peras de goma (pequeña, mediana, grande), con cono para conexión, tubo con racor metálico y manómetro.

Dynamomètre, complet en boîte plastique, composé de 3 poires (petite, moyenne et grosse) avec raccords coniques, tube et manomètre.

Dinamometro completo in scatola di plastica, composto da 3 perette (piccola, media, grande) con raccordo conico, tubo e manometro



1/2

18-0158
 1,5 m, 60"

Maßband aus Wachstuch, mit Millimeter-Einteilung, in Kunststoffgehäuse

Tape measure of oilcloth, graduated in millimeters, in plastic case

Cinta métrica de tela encerada, graduada en milímetros, en caja de plástico

Ruban métrique toile cirée en boîtier plastique

Nastro metrico di tela in millimetri in scatola di plastica

► **18-0160**
 2 m, 80"

Stahlmaßband mit Millimeter-Einteilung, in Metallgehäuse

Steel tape measure, graduated in millimeters, in metal case

Cinta métrica de acero, graduada en milímetros, en caja de metal

Ruban métrique acier en boîtier métal

Nastro metrico di acciaio, in millimetri in scatola di metallo

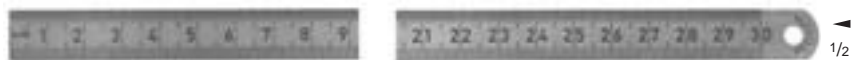

1/2

18-0161 15 cm, 6"

18-0164 20 cm, 8"

► **18-0162** 30 cm, 12"

18-0163 50 cm, 20"

Stahl-Maßstäbe, mit Millimeter-Einteilung

Steel rules, graduated in millimeters

Regla graduada en milímetros

Règle en acier, graduée en millimètres

Righe graduate in acciaio, millimetri



1/2

18-0165
 50 cm, 20"

Röntgen-Maßstab, mit Millimeter-Einteilung

Ruler for x-ray, graduated in millimeters

Regla graduada en milímetros para rayos-x

Règle radiologique graduée en millimètres

Riga graduata per misure radiologiche, in millimetri



Meßbereich: 15 mm
 Measuring range: 15 mm
 Alcance de medición: 15 mm
 Calibre: 15 mm
 Campo di misura: 15 mm



CASTROVIEJO
 63-1800
 8 cm, 3 1/8"

Zirkel
 Caliper
 Compás
 Compas
 Compasso

Meßbereich: 20 mm
 Measuring range: 20 mm
 Alcance de medición: 20 mm
 Calibre: 20 mm
 Campo di misura: 20 mm



CASTROVIEJO
 63-1801
 8 cm, 3 1/8"

Zirkel
 Caliper
 Compás
 Compas
 Compasso

Meßbereich: 40 mm
 Measuring range: 40 mm
 Alcance de medición: 40 mm
 Calibre: 40 mm
 Campo di misura: 40 mm



CASTROVIEJO
 18-0147
 9 cm, 3 1/2"

Zirkel
 Caliper
 Compás
 Compas
 Compasso

Meßbereich: 40 mm
 Measuring range: 40 mm
 Alcance de medición: 40 mm
 Calibre: 40 mm
 Campo di misura: 40 mm



CASTROVIEJO
 18-0148
 17 cm, 6 3/4"

Zirkel
 Caliper
 Compás
 Compas
 Compasso



Meßbereich: 180°
 Measuring range: 180°
 Alcance de medición: 180°
 Calibre: 180°
 Campo di misura: 180°

MÖLTGEN
 18-0140
 23 cm, 9"

Winkelmesser für Gliedmaßen
 Goniometer (flexometer)
 Goniómetro para extremidades
 Goniomètre pour les membres
 Goniometro per le membra



Meßbereich: 155 mm
 Measuring range: 155 mm
 Alcance de medición: 155 mm
 Calibre: 155 mm
 Campo di misura: 155 mm

18-0167
 23,5 cm, 9 1/4"

Schieblehre
 Caliper
 Calibrador
 Pied à coulisse
 Calibratore



Binokulare Kopflupen
 Binocular Head Magnifiers
 Lupas frontales binoculares
 Loupes binoculaires frontales
 Lenti binoculari frontali



BERGER
18-0241

Binokulare Kopflupe, mit 2 auswechselbaren prismatischen Linsen, Vergrößerung 2,5x (bei ca. 130 mm Arbeitsabstand = 7 Dioptrien), in weißemaltem Metallgehäuse, mit verstellbarem Federstahl-Stirnband.

Binocular head magnifier with 2 interchangeable prismatic lenses, magnification 2.5x (at a working distance of about 130 mm = 7 diopters), in white enamelled metal frame, with adjustable spring-steel head band.

Lupa frontal binocular con 2 lentes prismáticas intercambiables, aumento 2,5x (con distancia de observación de aprox. 130 mm = 7 dioptrías), en montura esmaltada en blanco, con cinta de acero de resorte regulable.

Loupe binoculaire frontale, avec 2 lentilles prismatiques interchangeables agrandissement 2,5x (à une distance d'observation de 130 mm environ = 7 dioptries), monture métallique, vernie émail blanc, avec bandeau frontal en acier à ressort.

Lente binoculare frontale, con 2 lenti prismatiche intercambiabili, ingrandimento: 2,5x (a una distanza d'osservazione di circa mm. 130 = 7 diottrie) in montatura metallica smaltata bianca, con fascia frontale in acciaio a molla.



BERGER
18-0243

Binokulare Kopflupe, mit 2 auswechselbaren prismatischen Linsen, Vergrößerung 2,5x (bei ca. 130 mm Arbeitsabstand = 7 Dioptrien), in weißemaltem Metallgehäuse, **aufklappbar**, mit verstellbarem Federstahl-Stirnband.

Binocular head magnifier with 2 interchangeable prismatic lenses, magnification 2.5x (at a working distance of about 130 mm = 7 diopters), in white enamelled metal frame, **swivel**, with adjustable spring-steel head band.

Lupa frontal binocular con 2 lentes prismáticas intercambiables, aumento 2,5x (con distancia de observación de aprox. 130 mm = 7 dioptrías), en montura esmaltada en blanco, **móvil**, con cinta de acero de resorte regulable.

Loupe binoculaire frontale, avec 2 lentilles prismatiques interchangeables agrandissement 2,5x (à une distance d'observation de 130 mm environ = 7 dioptries), monture métallique, vernie émail blanc, **escamotable**, avec bandeau frontal en acier à ressort.

Lente binoculare frontale, con 2 lenti prismatiche intercambiabili, ingrandimento: 2,5x (a una distanza d'osservazione di circa mm. 130 = 7 diottrie) in montatura metallica smaltata bianca, **ruotabile**, con fascia frontale in acciaio a molla.

Ersatzteile • Spare parts • Piezas de repuesto • Pieces de rechange • Pezzi di ricambio



| | |
|----------------|---|
| Vergrößerung | Arbeitsabstand (mm = Dioptrien) |
| Magnification | Working distance (mm = diopters) |
| Aumento | Distancia de observación (mm = dioptrías) |
| Agrandissement | Distance d'observation (mm = dioptries) |
| Ingrandimento | Distanza d'osservazione (mm = diottrie) |

| | | |
|---------|-----|------------------------|
| 18-0244 | 1,5 | 220 mm = 4 dioptr. |
| 18-0245 | 2,0 | 170 mm = 5 1/2 dioptr. |
| 18-0246 | 2,5 | 130 mm = 7 dioptr. |
| 18-0247 | 3,0 | 100 mm = 8 1/2 dioptr. |

Optik mit 2 Linsen für BERGER Kopflupen
 Twinlenses for BERGER binocular head magnifiers
 Lente doble para lupas binoculares frontales de BERGER
 Optique avec 2 lentilles pour loupe binoculaire de BERGER
 Ottica con 2 lenti per lenti binoculari frontali BERGER

Binokulare Lupenbrille
 Binocular Magnifying Spectacles
 Gafas de lupa binocular
 Lunettes à loupes binoculaires
 Occhiali a lenti binoculari

Binokulare Kopflupe
 Binocular Head Magnifier
 Lupa frontal binocular
 Loupe binoculaire frontale
 Lente binoculare frontale



flexibler Bügel
 malleable bow
 arco flexible
 branche flexible
 arco flessibile

18-0250

Binokulare Lupenbrille, bestehend aus Brillengestell und Lupe, Vergrößerung 1,8x, Arbeitsabstand ca. 40 cm, Gesichtsfeld ca. ø 10 cm, Augenabstand sowie Blickfeld sind verstellbar.

Binocular magnifying glass spectacles, consisting of spectacle frame and loupe, magnifying 1.8x, free working distance 40 cm approx., vision field ø 10 cm, working distance and size of field adjustable.

Gafas de lupa binocular, compuesta de montura y lupa, aumento 1,8x, distancia de observación de aprox. 40 cm, campo de visión ø 10 cm aprox., distancia y campo ajustable.

Lunettes à loupe binoculaire, composées de la monture et de la loupe, agrandissement 1,8x, distance d'observation 40 cm environ, champ de vision ø 10 cm environ, l'écart interpupillaire ainsi que le champ de vision sont réglables.

Occhiali a lenti binoculari, composti di montatura e lente, ingrandimento 1,8x, distanza di osservazione circa 40 cm, campo visivo ø 10 cm circa, la distanza fra gli occhi e campo visivo è regolabile.



18-0252

Binokulare Kopflupe, bestehend aus schwarzem Stirnband aus Celluloid und Lupe, Vergrößerung 1,8x, Arbeitsabstand ca. 40 cm, Gesichtsfeld ca. ø 10 cm, Augenabstand sowie Blickfeld sind verstellbar.

Binocular head magnifier, consisting of headband of black celluloid and magnifying glass, magnifying 1.8x, free working distance 40 cm approx., vision field ø 10 cm, working distance and size of field adjustable.

Lupa frontal binocular, compuesta de cinta frontal de celuloide negro y lupa, aumento 1,8x, distancia de observación de aprox. 40 cm, campo de visión ø 10 cm aprox., distancia y campo ajustable.

Loupe binoculaire frontale, composée d'un bandeau frontal noir en cellulose et loupe, agrandissement 1,8x, distance d'observation 40 cm environ, champ de vision ø 10 cm environ, l'écart interpupillaire ainsi que le champ de vision sont réglables.

Lente binoculare frontale, composta da fascia frontale di cellulose nera e lente, ingrandimento 1,8x, distanza di osservazione circa 40 cm, campo visivo ø 10 cm circa, la distanza fra gli occhi e campo visivo è regolabile.

Ersatzteile • Spare parts • Piezas de repuesto • Pieces de rechange • Pezzi di ricambio



18-0255

Lupe allein, Vergrößerung 1,8x, für 18-0250 und 18-0252
 Magnifying glass only, magnifying 1.8x, for 18-0250 and 18-0252
 Lente de aumento suelta, aumento 1,8x, para 18-0250 y 18-0252
 Loupe seule, agrandissement 1,8x, pour 18-0250 et 18-0252
 Lente sola, ingrandimento 1,8x, per 18-0250 e 18-0252



18-0260

2 Zusatzlinsen, Vergrößerung 2,0x, für 18-0250 - 18-0255
 2 Accessory lenses, magnifying 2.0x, for 18-0250 - 18-0255
 2 Lentes adicionales, aumento 2,0x, para 18-0250 - 18-0255
 2 lentilles supplémentaires agrandissement 2,0x pour 18-0250 - 18-0255
 2 lenti addizionali, ingrandimento 2,0x per 18-0250 - 18-0255

18-0257

2 Zusatzlinsen, Vergrößerung 2,5x, für 18-0250 - 18-0255
 2 Accessory lenses, magnifying 2.5x, for 18-0250 - 18-0255
 2 Lentes adicionales, aumento 2,5x, para 18-0250 - 18-0255
 2 lentilles supplémentaires agrandissement 2,5x pour 18-0250 - 18-0255
 2 lenti addizionali, ingrandimento 2,5x per 18-0250 - 18-0255



Stirnspiegel
Head Mirrors
Espejos frontales
Miroirs frontaux
Specchi frontali



ZIEGLER
18-0200
ø 90 mm

Reflexspiegel, komplett, bestehend aus:
18-0220 1 Stirnspiegel ø 90 mm, mit Gummifassung
18-0210 1 Stirnband aus schwarzem Plastik, mit Kugelgelenk

Head mirror, complete, consisting of:
18-0220 1 Head mirror ø 90 mm, with rubber coating
18-0210 1 Head band of black plastic, with ball-and-socket joint

Espejo frontal, completo, compuesto de:
18-0220 1 Espejo frontal ø 90 mm, con montura de goma
18-0210 1 Cinta frontal de plástico negro, con articulación esférica

Miroir frontal, complet, composé de:
18-0220 1 Miroir frontal d'un ø de 90 mm, avec monture caoutchouc
18-0210 1 Bandeau articulé en plastique noir

Specchio frontale, composto di:
18-0220 1 Specchio frontale ø 90 mm, con incastratura di gomma
18-0210 1 Fascia frontale di materia plastica nera, con sondo sferico

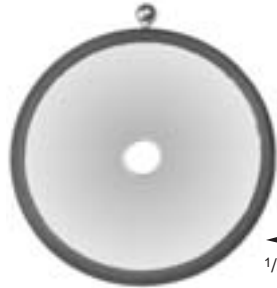

ZIEGLER
► 18-0220 ø 90 mm
18-0221 ø 100 mm

Stirnspiegel allein, mit Gummifassung

Head mirrors only, with rubber coating

Espejos frontales sueltos, con montura de goma

Miroir frontal, seul, avec monture caoutchouc

Specchi frontali, solo, con incastratura di gomma



18-0213

Gelenk allein, für Stirnband und -spiegel

Joint only, for head band and mirror

Articulación suelta, para cinta y espejo frontal

Articulation, seule, pour bandeau et miroir frontal

Snodo sferico solo, per fascia frontale e specchio frontale



ZIEGLER
18-0210

Stirnband aus schwarzem Plastik, mit Gelenk
Head band of black plastic, with joint
Cinta de plástico negro, con articulación
Bandeau frontal plastique noir, avec articulation
Fascia frontale di materia plastica nera, con snodo sferico



MURPHY
18-0211

Stirnband aus weißem Celluloid, mit Gelenk
Head band of white celluloid, with joint
Cinta de celuloide blanco, con articulación
Bandeau frontal en celluloid blanc, avec articulation
Fascia frontale di celluloido bianca, con snodo sferico

Stirnlampen für Schwachstrom
 Head Lamps for low voltage current
 Lámparas frontales para corriente de baja tensión
 Eclairage frontal pour courant à basse tension
 Lampade frontali con energia elettrica a bassa tensione



CLAR
 18-0301

Stirnlampe (6 Volt), komplett mit Reflektor ø 55 mm, verstellbarem Gelenk, weißem Stirnband aus Celluloid, Schaumgummipolsterung und Kabel mit Zwischenstecker zu Trafo 18-0325.

Head light (6 volts), complete with mirror ø 55 mm, adjustable joint, white celluloid head band, foam rubber pad and cord with plugs for transformer 18-0325.

Lámpara frontal (6 voltios), completa con reflector ø 55 mm, articulación regulable, cinta frontal de celuloide, almohadilla de goma-espuma y cable con enchufe intermedio para transformador 18-0325.

Eclaireur frontal (6 volts), complet avec réflecteur ø 55 mm, articulation réglable, bandeau frontal en celluloid blanc, coussin en caoutchouc mousse, et cordon avec fiche intermédiaire pour transformateur 18-0325.

Lampada (6 volt), completa con specchio riflettore ø 55 mm, sondo regolabile, fascia frontale bianca di celuloide, imbottitura frontale e cavo con spina intermedia per trasformatore 18-0325.

Ersatzteile • Spare parts • Piezas de repuesto
 Pièces de rechange • Pezzi di ricambio

18-0304

Reflektor ø 55 mm
 Mirror ø 55 mm
 Reflector ø 55 mm
 Réflecteur ø 55 mm
 Riflettore ø 55 mm

18-0307

Ersatzbirne 6 Volt
 Spare bulb, 6 volts
 Bombilla de repuesto, 6 voltios
 Lampe de rechange, 6 volts
 Lampadina di ricambio, 6 volt

18-0305

Stirnband aus weißem Celluloid, mit Kabelaschen und Schaumgummipolsterung
 Head band of white celluloid, with cable clips and foam rubber pad
 Cinta frontal de celuloide blanco con bridas de cable y almohadilla de goma-espuma
 Bandeau frontal en celluloid blanc, anses pour le cordon et coussin en caoutchouc mousse.
 Fascia frontale di celuloide bianca, porta-cordini e imbottitura frontale

18-0308

Ersatz-Schaumgummipolsterung für Stirnband
 Spare foam rubber pad for head band
 Almohadilla de goma-espuma de repuesto para cinta frontal
 Coussin en caoutchouc de rechange pour bandeau frontal
 Imbottitura frontale per fascia frontale



JANSEN
 18-0335

Stirnlampe (6 Volt), komplett mit verstellbarem Fokus und Gelenk, schmalen Stirnband aus weißem Celluloid und Kabel mit Zwischenstecker zu Trafo 18-0325.

Head lamp (6 volts), complete with adjustable focus and joint, narrow head band of white celluloid and cord with plugs for transformer 18-0325.

Lámpara frontal (6 voltios), completa con foco regulable y articulación, cinta frontal estrecha y blanca de celuloide y cable con enchufe intermedio para transformador 18-0325.

Eclaireur frontal (6 volts), complet avec foyer réglable et articulation, bandeau frontal en celluloid blanc, et cordon avec fiche intermédiaire pour transformateur 18-0325.

Lampada (6 volt), completa con messa a fuoco regolabile, sondo, fascia frontale bianca di celuloide, imbottitura frontale e cavo con spina intermedia per trasformatore 18-0325.

18-0303

Ersatzbirne 6 Volt
 Spare bulb, 6 volts
 Bombilla de repuesto, 6 voltios
 Lampe de rechange, 6 volts
 Lampadina di ricambio, 6 volt



18-0325

Klein-Transformator für 220 Volt Wechselstrom, mit Gummikabel und Steckbuchse für Schwachstrom, stufenlos regelbar 0-10 Volt.

Mini-transformer unit for 220 volts alternating current, with cable and outlet for low voltage current, infinitely variable from 0-10 volts.

Transformador eléctrico pequeño para 220 voltios corriente alterna, con cable y borne para corriente de baja tensión, regulador sin escalones desde 0-10 voltios.

Petit transformateur fonctionnant sur 220 volts, C.A., avec cordon en caoutchouc et fiches pour courant à basse tension, réglage continu 0-10 volts.

Mini-trasformatore elettrico, per 220 volt, corrente alternata a bassa tensione, regolazione continua da 0-10 volt.



Zungenspatel
Tongue Depressors
Depresor lingual
Abaisse-langues
Abbassalingua



80-0372
14 cm, 5 1/2"



80-0370
14,5 cm, 5 3/4"

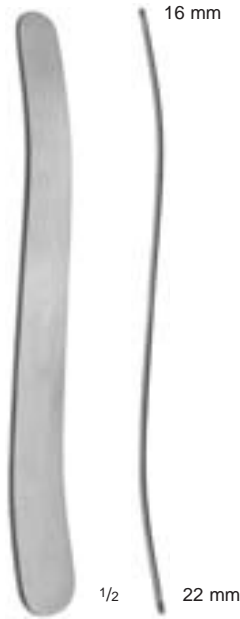

MAYO
80-0373
16 cm, 6 1/4"

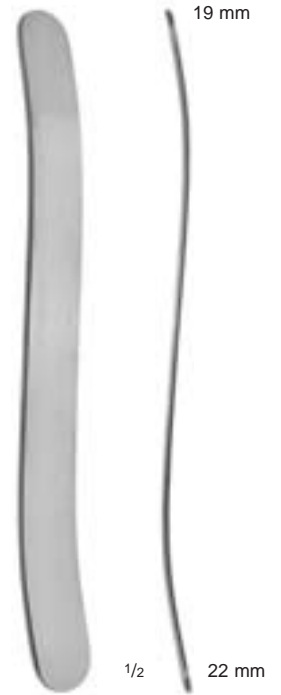

BUCHWALD
80-0376
18 cm, 7"

aus Holz, in Packung zu 100 Stück
of wood, in package of 100 pieces
de madera, en paquete de 100 piezas
en bois, en paquet de 100 pièces
di legno, per 100 pezzi

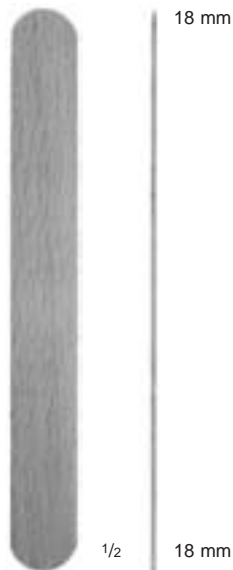

80-0377
15 cm, 6"

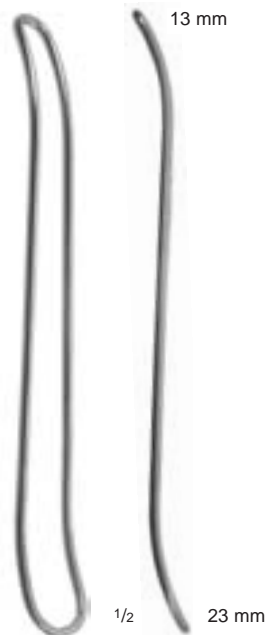

FRENZEL
80-0379
16,5 cm, 6 1/2"



BRUENINGS
80-0378
19 cm, 7 1/2"

Kehlkopfspiegel
Laryngeal Mirrors
Espejos laringeos
Miroirs laryngiens
Specchi laringei

Metallgriffe
Metal Handles
Mangos metálicos
Manches en métal
Manici metallici

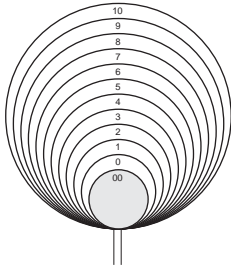

- 85-1100 Fig.00 = ø 8 mm
 - 85-1101 Fig. 0 = ø 10 mm
 - 85-1102 Fig. 1 = ø 12 mm
 - 85-1103 Fig. 2 = ø 14 mm
 - 85-1104 Fig. 3 = ø 16 mm
 - 85-1105 Fig. 4 = ø 18 mm
 - 85-1106 Fig. 5 = ø 20 mm
 - 85-1107 Fig. 6 = ø 22 mm
 - 85-1108 Fig. 7 = ø 24 mm
 - 85-1109 Fig. 8 = ø 26 mm
 - ▶ 85-1110 Fig. 9 = ø 28 mm
 - 85-1111 Fig.10 = ø 30 mm
- 13,0 – 14,5 cm, 5¹/₈ – 5³/₄"

Kehlkopfspiegel ohne Griff
Laryngeal mirrors without handle
Espejos laringeos sin mango
Miroirs laryngiens sans manche
Specchi laringei senza manico



85-1132
9,5 cm, 3³/₄"

Metallgriff für Kehlkopfspiegel
85-1100 – 85-1111

Metal handle for laryngeal mirrors
85-1100 – 85-1111

Mango metálico para espejos laringeos
85-1100 – 85-1111

Manche en métal pour miroirs laryngiens
85-1100 – 85-1111

Manici metallici per specchi laringei
85-1100 – 85-1111



85-1130
11 cm, 4³/₈"

Metallgriff für Kehlkopfspiegel
85-1100 – 85-1111

Metal handle for laryngeal mirrors
85-1100 – 85-1111

Mango metálico para espejos laringeos
85-1100 – 85-1111

Manche en métal pour miroirs laryngiens
85-1100 – 85-1111

Manici metallici per specchi laringei
85-1100 – 85-1111



Kehlkopfspiegel
Laryngeal Mirrors
Espejos laríngeos
Miroirs laryngiens
Specchi laringei

Rhinoskopiespiegel
Rhinoscopic Mirrors
Espejos rinoscópicos
Miroirs pour rhinoscopie
Specchi per rinoscopia

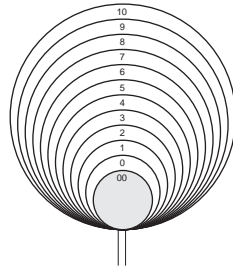
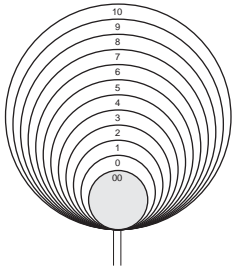

85-0149
ø 10 mm



▶ 85-0150
ø 12 mm



85-0151
ø 14 mm



85-0152
ø 16 mm



MICHEL
85-0149

- 85-0152
27,0 – 28,0 cm, 10^{3/4} – 11^{1/4}“

Rhinoskopiespiegel, beweglich
Rhinoscopic mirrors, moveable
Espejos rinoscópicos, movable
Miroirs pour rhinoscopie, mobiles
Specchi per rinoscopia, mobili

- 85-0120 Fig.00 = ø 8 mm
 - 85-0121 Fig. 0 = ø 10 mm
 - 85-0122 Fig. 1 = ø 12 mm
 - 85-0123 Fig. 2 = ø 14 mm
 - 85-0124 Fig. 3 = ø 16 mm
 - 85-0125 Fig. 4 = ø 18 mm
 - 85-0126 Fig. 5 = ø 20 mm
 - 85-0127 Fig. 6 = ø 22 mm
 - ▶ 85-0128 Fig. 7 = ø 24 mm
 - 85-0129 Fig. 8 = ø 26 mm
 - 85-0130 Fig. 9 = ø 28 mm
 - 85-0131 Fig.10 = ø 30 mm
- 18,0 – 19,5 cm, 7 – 7^{3/4}“

Kehlkopfspiegel mit festem Griff
Laryngeal mirrors with fixed handle
Espejos laríngeos con mango fijo
Miroirs laryngiens avec manche fixe
Specchi laringei con manico fisso

- 85-0100 Fig.00 = ø 8 mm
 - 85-0101 Fig. 0 = ø 10 mm
 - 85-0102 Fig. 1 = ø 12 mm
 - 85-0103 Fig. 2 = ø 14 mm
 - 85-0104 Fig. 3 = ø 16 mm
 - 85-0105 Fig. 4 = ø 18 mm
 - 85-0106 Fig. 5 = ø 20 mm
 - ▶ 85-0107 Fig. 6 = ø 22 mm
 - 85-0108 Fig. 7 = ø 24 mm
 - 85-0109 Fig. 8 = ø 26 mm
 - 85-0110 Fig. 9 = ø 28 mm
 - 85-0111 Fig.10 = ø 30 mm
- 22,0 – 23,5 cm, 8^{3/4} – 9^{1/4}“

Kehlkopfspiegel mit festem Griff
Laryngeal mirrors with fixed handle
Espejos laríngeos con mango fijo
Miroirs laryngiens avec manche fixe
Specchi laringei con manico fisso



LAWNTON

Medizintechnik



Vorbereitung, Dermatologie
Preparation, Dermatology
Preparación, Dermatología
Préparation, Dermatologie
Preparazione, Dermatologia



Nagelhautscheren
Cuticle Scissors
Tijeras cuticulares
Ciseaux à envies
Forbici per la cuticola

Nagelscheren
Nail Scissors
Tijeras para uñas
Ciseaux à ongles
Forbici per unghie



► 19-0399
8,5 cm, 3³/₈"

19-0400
8,5 cm, 3³/₈"

19-0399
- 19-0400

Nagelhautscheren
Cuticle scissors
Tijeras cuticulares
Ciseaux à envies
Forbici per la cuticola



► 19-0402
9,5 cm, 3³/₄"

19-0403
9,5 cm, 3³/₄"

19-0402
- 19-0403

Nagelscheren
Nail scissors
Tijeras para uñas
Ciseaux à ongles
Forbici per unghie

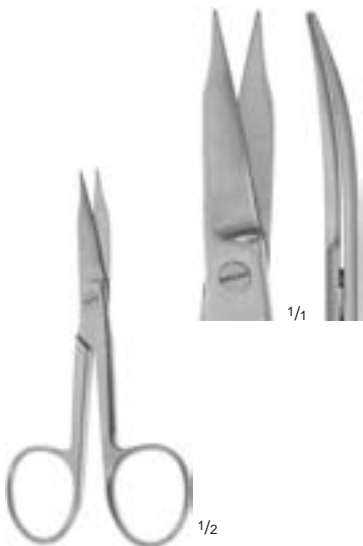

19-0460
10 cm, 4"

Nagelschere
Nail scissors
Tijera para uñas
Ciseaux à ongles
Forbici per unghie

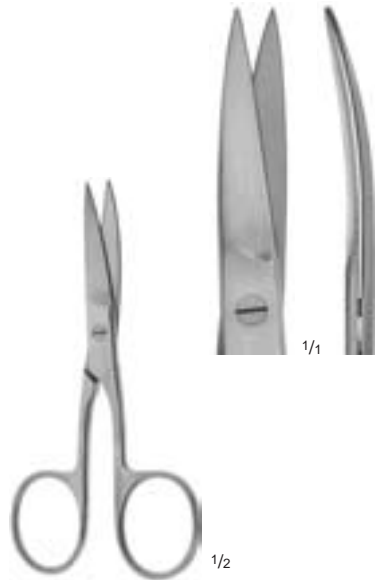

19-0483
10,5 cm, 4¹/₈"

Nagelschere
Nail scissors
Tijera para uñas
Ciseaux à ongles
Forbici per unghie

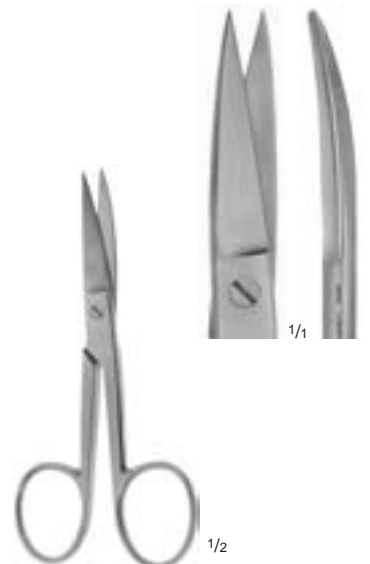

19-0487
10,5 cm, 4¹/₈"

Nagelschere
Nail scissors
Tijera para uñas
Ciseaux à ongles
Forbici per unghie

Nagelhautzangen
 Cuticle Nippers
 Pinzas cuticulares
 Pincès à envies
 Tronchesine per la cuticola

Nagelzangen
 Nail Nippers
 Pinzas corta-uñas
 Pincès à ongles
 Tronchesine per unghie



19-0358
 10,5 cm, 4 1/8"

Nagelhautzange
 Cuticle nipper
 Pinza cuticular
 Pincès à envies
 Tonchesina per la cuticola



19-0360
 10,5 cm, 4 1/8"

Nagelhautzange
 Cuticle nipper
 Pinza cuticular
 Pincès à envies
 Tonchesina per la cuticola



19-0305
 12,5 cm, 5"

Nagelspaltzange
 Nail splitter forceps
 Pinza corta-uñas
 Pincès à ongles
 Tonchesina per unghie



19-0325
 14 cm, 5 1/2"

Nagelzange
 Nail nipper
 Pinza corta-uñas
 Pincès à ongles
 Tonchesina per unghie

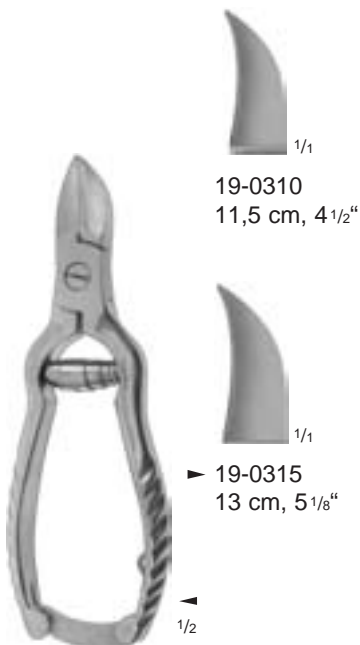

19-0310
 11,5 cm, 4 1/2"

19-0315
 13 cm, 5 1/8"

19-0310
 - 19-0315

Nagelzangen
 Nail nippers
 Pinzas corta-uñas
 Pincès à ongles
 Tonchesina per unghie



19-0302
 13 cm, 5 1/8"

Nagelzange
 Nail nipper
 Pinza corta-uñas
 Pincès à ongles
 Tonchesina per unghie

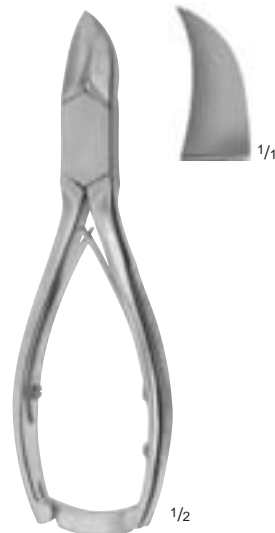

19-0300
 14 cm, 5 1/2"

Nagelzange
 Nail nipper
 Pinza corta-uñas
 Pincès à ongles
 Tonchesina per unghie

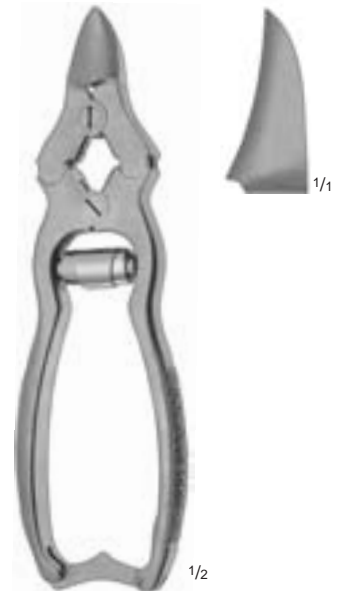

19-0307
 15,5 cm, 6"

Nagelzange
 Nail nipper
 Pinza corta-uñas
 Pincès à ongles
 Tonchesina per unghie



Nagelfeilen
Nail Files
Limas para uñas
Limes à ongles
Lime per le unghie

Schwesterngarnitur
Set for Nurses
Surtido para enfermeras
Etui pour infirmières
Necessario per infermiera



19-0517
11 cm, 4 3/8"

Nagelfeile
Nail file
Lima para uñas
Lime à ongles
Lima per unghie



19-0521 10 cm, 4"
▶ 19-0522 12 cm, 4 3/4"

Nagelfeilen
Nail files
Limas para uñas
Limes à ongles
Lime per unghie



19-0530
13 cm, 5 1/8"

Nagelfeile mit Diamantstaub belegt, mit Kunststoffgriff

Diamond cover coated nail file, with plastic handle

Lima para uñas cubierta con polvo de diamante, con mango de plástico

Lime à ongles revêtue de diamant indestructible, avec manche en plastique

Lima per unghie diamantata, con manico di plastica



19-0410

Schwesterngarnitur, 2-teilig in Plastiketui, bestehend aus 1 Nagelschere (19-0403), 1 Nagelfeile (19-0521) und 1 Kette, 35 cm lang.

Set for nurses, two part in plastic case, consisting of: 1 nail scissors (19-0403), 1 nail file (19-0521) and 1 chain, 35 cm long.

Surtido para enfermeras, de 2 piezas en estuche de plástico, compuesto de 1 tijera de uñas (19-0403), 1 lima de uñas (19-0521) y 1 cadena, 35 cm de larga.

Etui pour infirmières, en 2 parties, étui en matière plastique contenant 1 ciseaux à ongles (19-0403), 1 lime à ongles (19-0521) et 1 chaîne, 35 cm de long.

Necessario per infermiera, in busta di plastica, composto di: 1 forbici per unghie (19-0403), 1 lima per unghie (19-0521) e 1 catena, lunghezza 35 cm

Lupusschaber
Lupus Scraper
Legra para lupus
Grattoir pour lupus
Cucchiaio per lupus

Komedonenquetscher
Comedo Extractors
Saca-comedones
Tire-comédons
Tiracomedoni



VIDAL
19-0230
14 cm, 5 1/2"

Lupusschaber
Lupus scraper
Legra para lupus
Grattoir pour lupus
Cucchiaio per lupus

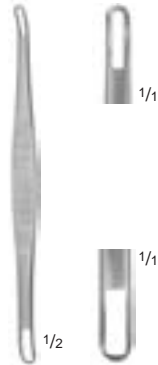

SCHAMBERG
19-0130
9,5 cm, 3 3/4"

Komedonenquetscher
Comedo extractor
Saca-comedones
Tire-comédons
Tiracomedoni



UNNA
19-0101
13,5 cm, 5 1/4"

Komedonenquetscher
Comedo extractor
Saca-comedones
Tire-comédons
Tiracomedoni



UNNA
19-0100
14,5 cm, 5 3/4"

Komedonenquetscher
Comedo extractor
Saca-comedones
Tire-comédons
Tiracomedoni

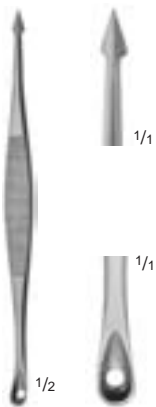

SAALFELD
19-0120
10,5 cm, 4 1/8"

Komedonenquetscher, mit Lanze
Comedo extractor, with lancet
Saca-comedones, con lanceta
Tire-comédons, avec lancette
Tiracomedoni, con lancetta

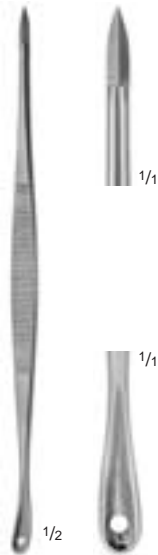

SAALFELD
19-0125
14,5 cm, 5 3/4"

Komedonenquetscher, mit Messer
Comedo extractor, with acne knife
Saca-comedones, con escarificador
Tire-comédons, avec couteau
Tiracomedoni, con cucchiaio



KATSCH
19-0110
14,5 cm, 5 3/4"

Komedonenquetscher, mit Lanze
Comedo extractor, with lancet
Saca-comedones, con lanceta
Tire-comédons, avec lancette
Tiracomedoni, con lancetta



UNNA-VIDAL
19-0135
18 cm, 7"

Komedonenquetscher, mit Nadel, umschraubbar
Comedo extractor, with needle, reversible
Saca-comedones, con aguja, reversible
Tire-comédons, avec aiguille, reversible
Tiracomedoni, con ago, reversibile



Lupusküretten
Lupus Currettes
Curetas para lupus
Curettes pour les lupus
Raschiatoio per lupus

Hautstanzen
Dermal Punches
Trépanos cutáneos
Trépanos cutanés
Trapani dermatici



19-0250
3 mm



▶ 19-0251
4 mm



19-0252
5 mm



19-0253
6 mm

1/2

FOX
19-0250
- 19-0253
14 cm, 5 1/2"

Lupusküretten
Lupus currettes
Curetas para lupus
Curettes pour les lupus
Raschiatoio per lupus



19-0260
3 mm



19-0261
4 mm



▶ 19-0262
5 mm

1/2

PIFFARD
19-0260
- 19-0262
16 cm, 6 1/4"

Lupusküretten
Lupus currettes
Curetas para lupus
Curettes pour les lupus
Raschiatoio per lupus



19-0202 2 mm



19-0203 3 mm



19-0204 4 mm



19-0205 5 mm



19-0206 6 mm



▶ 19-0207 7 mm



19-0208 8 mm

1/2

KEYES
19-0202
- 19-0208
10 cm, 4"

Hautstanzen
Dermal punches
Trépanos cutáneos
Trépanos cutanés
Trapani dermatici

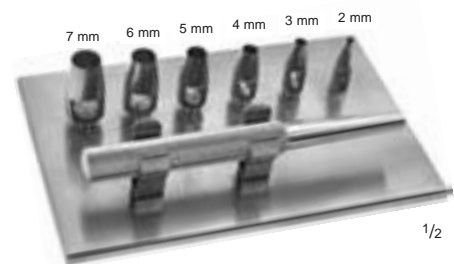

1/2

KEYES
19-0210

Hautstanzbesteck, komplett, mit 6 auswechselbaren Aufsätzen, Griff und Gestell

Dermal punch set, complete, with 6 interchangeable tips, handle and rack

Juego de trépanos cutáneos, completo con 6 insertadas intercambiables, mango y bastidor

Jeu de trépanos cutanés, complet, avec 6 embouts interchangeables, manche et support

Strumentario per trapanazione della pelle, completo di 6 teste punzonatrici intercambiabili, manico, su sostegno



LAWNTON

Medizintechnik



Narkose
Anaesthesia
Anestesia
Anesthésie
Anestesia



Mundkeil
Oral Screw
Garrote
Bâillon
Apribocca

Mundsperrer
Mouth Gags
Abre-bocas
Ouvre-bouches
Apriboccas



Ø 32 mm

1/2

MAUNDER
80-0275
9,5 cm, 3 3/4"

Mundkeil aus Holz
Oral screw of wood
Garrote de madera
Bâillon en bois
Apribocca di legno



1/2

HEISTER
80-0105
13 cm, 5 1/8"

Mundsperrer
Mouth gag
Abre-boca
Ouvre-bouches
Apribocca



1/2

DENHARDT
80-0100
12,5 cm, 5"

Mundsperrer
Mouth gag
Abre-boca
Ouvre-bouches
Apribocca



1/2

ROSER-KÖNIG
80-0112
18,5 cm, 7 1/4"

Mundsperrer
Mouth gag
Abre-boca
Ouvre-bouches
Apribocca



16-0325

- 1 Paar Ersatzgummi
- 1 pair of rubber pads
- 1 par de gomas de repuesto
- 1 paire de mors en caoutchouc
- 1 paio di morsi di ricambio

YOUNG
 16-0320
 15,5 cm, 6"

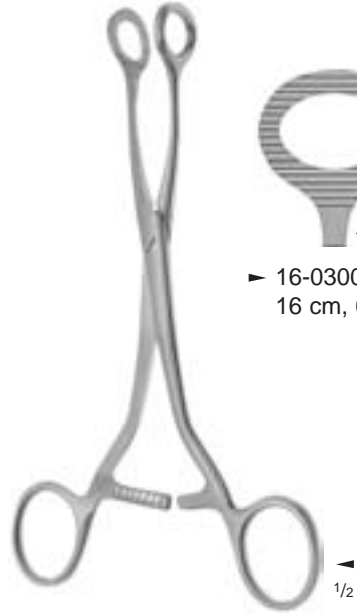

▶ 16-0300
 16 cm, 6 1/4"

16-0305
 18 cm, 7"

COLLIN
 16-0300
 - 16-0305

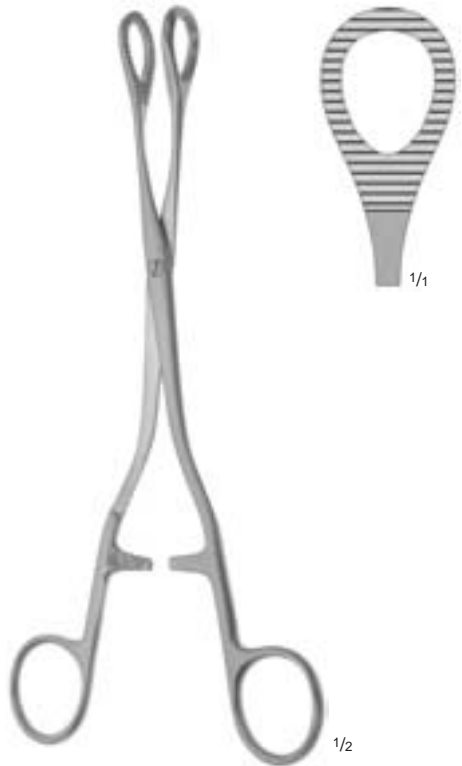

HEYWOOD-SMITH
 16-0338
 21 cm, 8 1/4"

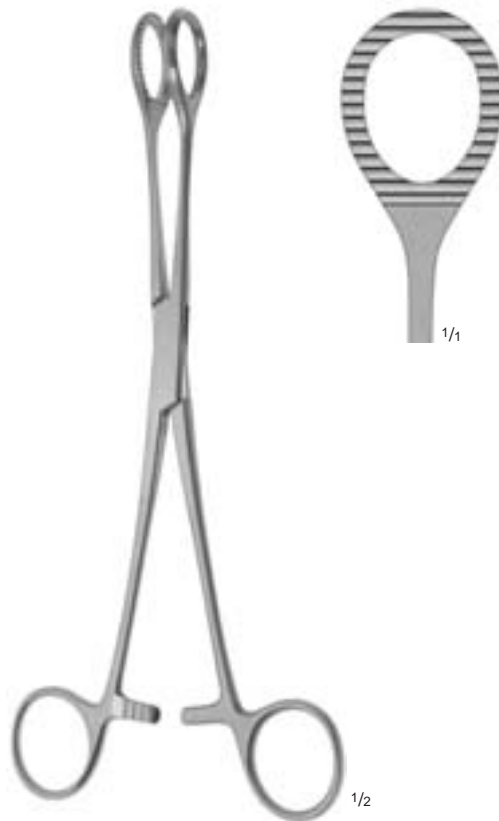

HEYWOOD-SMITH
 16-0340
 21,5 cm, 8 1/2"



MC INTOSH Laryngoskope
 MC INTOSH Laryngoscopes
 MC INTOSH Laringoscopios
 MC INTOSH Laryngoscopes
 MC INTOSH Laringoscopi



MC INTOSH 85-0090

Laryngoskopie-Besteck, bestehend aus:
 85-0073 1 Laryngoskopie-Spatel 70/92 mm
 85-0074 1 Laryngoskopie-Spatel 90/112 mm
 85-0075 1 Laryngoskopie-Spatel 110/132 mm
 85-0098 1 Batteriegriff ø 30 mm (ohne Batterien)
 85-0099 1 Etui

Laryngoscope set, consisting of:
 85-0073 1 Laryngoscope blade 70/92 mm
 85-0074 1 Laryngoscope blade 90/112 mm
 85-0075 1 Laryngoscope blade 110/132 mm
 85-0098 1 Battery handle, ø 30 mm (without batteries)
 85-0099 1 Case

Juego para laringoscopia, compuesto de:
 85-0073 1 Espátula de laringoscopia 70/92 mm
 85-0074 1 Espátula de laringoscopia 90/112 mm
 85-0075 1 Espátula de laringoscopia 110/132 mm
 85-0098 1 Mango de pila ø 30 mm (sin pilas)
 85-0099 1 Estuche

Trousse à laryngoscopie, composée de:
 85-0073 1 Spatule pour laryngoscopie 70/92 mm
 85-0074 1 Spatule pour laryngoscopie 90/112 mm
 85-0075 1 Spatule pour laryngoscopie 110/132 mm
 85-0098 1 Poignée à piles ø 30 mm (sans piles)
 85-0099 1 Boîte

Set per laringoscopia, composto da:
 85-0073 1 Spatola per laringoscopia 70/92 mm
 85-0074 1 Spatola per laringoscopia 90/112 mm
 85-0075 1 Spatola per laringoscopia 110/132 mm
 85-0098 1 Manico per pila ø 30 mm (senza pila)
 85-0099 1 astuccio

1/3



MC INTOSH 85-0091

Laryngoskopie-Besteck, bestehend aus:
 85-0073 1 Laryngoskopie-Spatel 70/92 mm
 85-0074 1 Laryngoskopie-Spatel 90/112 mm
 85-0075 1 Laryngoskopie-Spatel 110/132 mm
 85-0076 1 Laryngoskopie-Spatel 130/152 mm
 85-0098 1 Batteriegriff ø 30 mm (ohne Batterien)
 85-0072 1 Etui

Laryngoscope set, consisting of:
 85-0073 1 Laryngoscope blade 70/92 mm
 85-0074 1 Laryngoscope blade 90/112 mm
 85-0075 1 Laryngoscope blade 110/132 mm
 85-0076 1 Laryngoscope blade 130/152 mm
 85-0098 1 Battery handle, ø 30 mm (without batteries)
 85-0072 1 Case

Juego para laringoscopia, compuesto de:
 85-0073 1 Espátula de laringoscopia 70/92 mm
 85-0074 1 Espátula de laringoscopia 90/112 mm
 85-0075 1 Espátula de laringoscopia 110/132 mm
 85-0076 1 Espátula de laringoscopia 130/152 mm
 85-0098 1 Mango de pila ø 30 mm (sin pilas)
 85-0072 1 Estuche

Trousse à laryngoscopie, composée de:
 85-0073 1 Spatule pour laryngoscopie 70/92 mm
 85-0074 1 Spatule pour laryngoscopie 90/112 mm
 85-0075 1 Spatule pour laryngoscopie 110/132 mm
 85-0076 1 Spatule pour laryngoscopie 130/152 mm
 85-0098 1 Poignée à piles ø 30 mm (sans piles)
 85-0072 1 Boîte

Set per laringoscopia, composto da:
 85-0073 1 Spatola per laringoscopia 70/92 mm
 85-0074 1 Spatola per laringoscopia 90/112 mm
 85-0075 1 Spatola per laringoscopia 110/132 mm
 85-0076 1 Spatola per laringoscopia 130/152 mm
 85-0098 1 Manico per pila ø 30 mm (senza pila)
 85-0099 1 astuccio

1/3

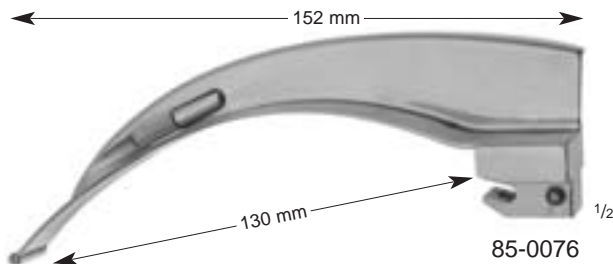
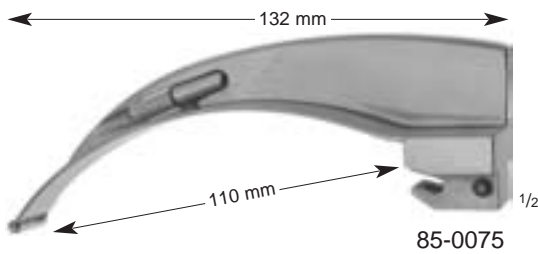
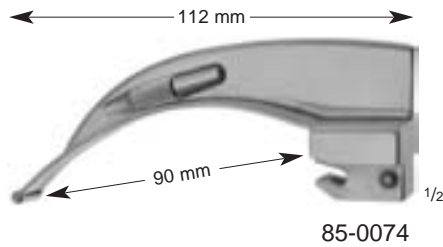
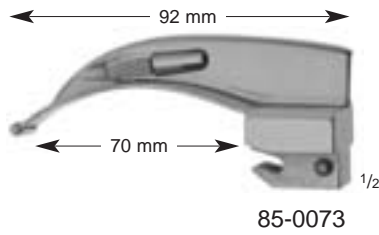
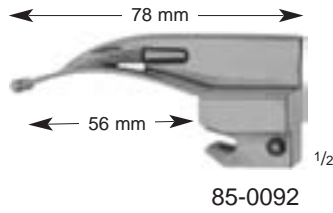
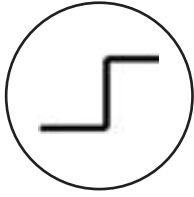

MC INTOSH
 85-0073
 - 85-0092
 Laryngoskopie-Spatel
 Laryngoscope blades
 Espátulas de laringoscopios
 Spatules de laryngoscopie
 Spatole per laringoscopi



85-0058
 2,5 V

Ersatzbirnchen für
 Laryngoskopie-Spatel
 85-0092

Spare bulb for
 laryngoscope blade
 85-0092

Bombilla de repuesto para
 espátula de laringoscopia
 85-0092

Lampe de rechange pour
 spatule de laryngoscope
 85-0092

Lampadine di ricambio per
 spatola per laringoscopia
 85-0092



85-0059
 2,5 V

Ersatzbirnchen für
 Laryngoskopie-Spatel
 85-0073 - 85-0076

Spare bulb for
 laryngoscope blades
 85-0073 - 85-0076

Bombilla de repuesto para
 espátulas de laringoscopios
 85-0073 - 85-0076

Lampe de rechange pour
 spatule de laryngoscope
 85-0073 - 85-0076

Lampadine di ricambio per
 spatola per laringoscopia
 85-0073 - 85-0076



85-0098
 14,5 cm, 5^{3/4}"

Batteriegriff ø 30 mm (2 Baby-
 Zellen, 1,5 Volt, sind erforderlich)

Battery handle, ø 30 mm (2 Baby
 batteries, 1.5 volt, are required)

Mango de pila ø 30 mm (se necesi-
 tan 2 pilas Mignon de 1,5 V)

Poignée à piles ø 30 mm (2 piles
 Mignon, 1,5 volts sont nécessaires)

Manico per pila ø 30 mm (2 pile
 Mignon di 1,5 volt sono necessarie)



85-0094
 15 cm, 6"

Batteriegriff ø 18 mm (2 Mini-
 Zellen, 1,5 Volt, sind erforderlich)

Battery handle, ø 18 mm (2 Mini
 batteries, 1.5 volt, are required)

Mango de pila ø 18 mm (se necesi-
 tan 2 pilas Mini de 1,5 V)

Poignée à piles ø 18 mm (2 piles
 Mini, 1,5 volts sont nécessaires)

Manico per pila ø 18 mm (2 pile
 Mini di 1,5 volt sono necessarie)



MC INTOSH Laryngoskope mit Kaltlicht
 MC INTOSH Laryngoscopes with Cold Light
 MC INTOSH Laringoscopios de luz fría
 MC INTOSH Laryngoscopes lumière froide
 MC INTOSH Laringoscopi luce fredda



1/3

MC INTOSH 85-0006

Laryngoskopie-Besteck, bestehend aus:

- 85-0002 1 Spatel mit Kaltlicht 70/92 mm
- 85-0003 1 Spatel mit Kaltlicht 90/112 mm
- 85-0004 1 Spatel mit Kaltlicht 110/132 mm
- 85-0009 1 Batteriegriff ø 30 mm (ohne Batterien)
- 85-0099 1 Etui

Laryngoscope set, consisting of:

- 85-0002 1 Blade with cold light 70/92 mm
- 85-0003 1 Blade with cold light 90/112 mm
- 85-0004 1 Blade with cold light 110/132 mm
- 85-0009 1 Battery handle, ø 30 mm (without batteries)
- 85-0099 1 Case

Juego para laringoscopia, compuesto de:

- 85-0002 1 Espátula con luz fría 70/92 mm
- 85-0003 1 Espátula con luz fría 90/112 mm
- 85-0004 1 Espátula con luz fría 110/132 mm
- 85-0009 1 Mango de pila ø 30 mm (sin pilas)
- 85-0099 1 Estuche

Trousse à laryngoscopie, composée de:

- 85-0002 1 Spatule lumière froide 70/92 mm
- 85-0003 1 Spatule lumière froide 90/112 mm
- 85-0004 1 Spatule lumière froide 110/132 mm
- 85-0009 1 Poignée à piles ø 30 mm (sans piles)
- 85-0099 1 Boîte

Set per laringoscopia, composto da:

- 85-0002 1 Spatola con luce fredda 70/92 mm
- 85-0003 1 Spatola con luce fredda 90/112 mm
- 85-0004 1 Spatola con luce fredda 110/132 mm
- 85-0009 1 Manico per pila ø 30 mm (senza pila)
- 85-0099 1 astuccio

MC INTOSH 85-0007

Laryngoskopie-Besteck, bestehend aus:

- 85-0002 1 Spatel mit Kaltlicht 70/92 mm
- 85-0003 1 Spatel mit Kaltlicht 90/112 mm
- 85-0004 1 Spatel mit Kaltlicht 110/132 mm
- 85-0005 1 Spatel mit Kaltlicht 130/152 mm
- 85-0009 1 Batteriegriff ø 30 mm (ohne Batterien)
- 85-0072 1 Etui

Laryngoscope set, consisting of:

- 85-0002 1 Blade with cold light 70/92 mm
- 85-0003 1 Blade with cold light 90/112 mm
- 85-0004 1 Blade with cold light 110/132 mm
- 85-0005 1 Blade with cold light 130/152 mm
- 85-0009 1 Battery handle, ø 30 mm (without batteries)
- 85-0072 1 Case

Juego para laringoscopia, compuesto de:

- 85-0002 1 Espátula con luz fría 70/92 mm
- 85-0003 1 Espátula con luz fría 90/112 mm
- 85-0004 1 Espátula con luz fría 110/132 mm
- 85-0005 1 Espátula con luz fría 130/152 mm
- 85-0009 1 Mango de pila ø 30 mm (sin pilas)
- 85-0072 1 Estuche

Trousse à laryngoscopie, composée de:

- 85-0002 1 Spatule lumière froide 70/92 mm
- 85-0003 1 Spatule lumière froide 90/112 mm
- 85-0004 1 Spatule lumière froide 110/132 mm
- 85-0005 1 Spatule lumière froide 130/152 mm
- 85-0009 1 Poignée à piles ø 30 mm (sans piles)
- 85-0072 1 Boîte

Set per laringoscopia, composto da:

- 85-0002 1 Spatola con luce fredda 70/92 mm
- 85-0003 1 Spatola con luce fredda 90/112 mm
- 85-0004 1 Spatola con luce fredda 110/132 mm
- 85-0005 1 Spatola con luce fredda 130/152 mm
- 85-0009 1 Manico per pila ø 30 mm (senza pila)
- 85-0072 1 astuccio

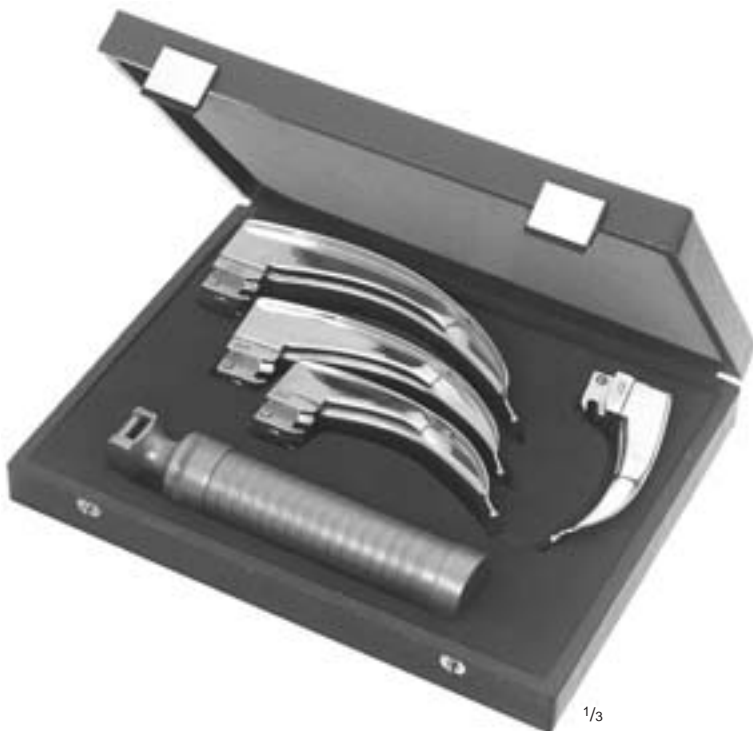

1/3

MC INTOSH Laryngoskope mit Kaltlicht
 MC INTOSH Laryngoscopes with Cold Light
 MC INTOSH Laringoscopios de luz fría
 MC INTOSH Laryngoscopes lumière froide
 MC INTOSH Laringoscopi luce fredda

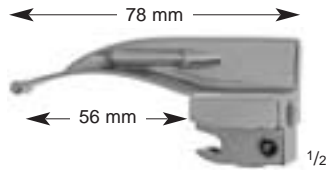
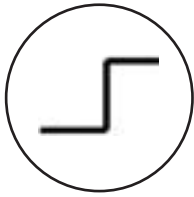

85-0001

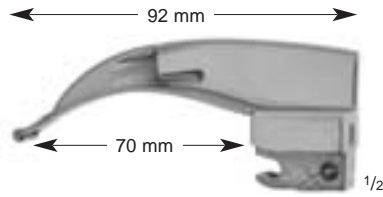

85-0002

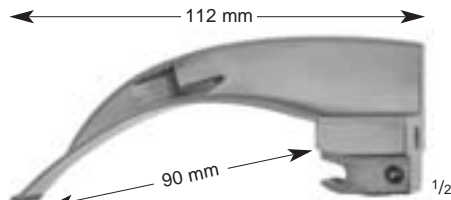

85-0003

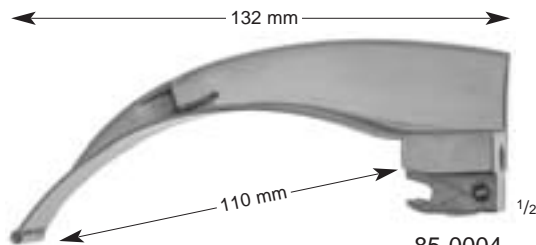

85-0004

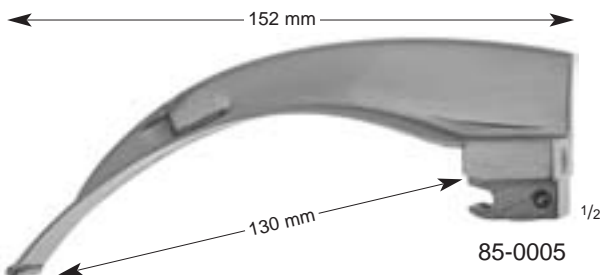

85-0005

MC INTOSH
 85-0001
 - 85-0005

Laryngoskopie-Spatel mit integriertem Kaltlichtträger
 Laryngoscope blades with integrated cold light carrier
 Espátulas de laringoscopios con luz fría integrada
 Spatules de laryngoscopie, avec lumière froide intégrée
 Spatole per laringoscopia, luce fredda



85-0008
 2,5 V

Ersatzbirnchen (Halogen) für
 Batteriegriff 85-0009

Spare bulb (Halogen) for
 battery handle 85-0009

Bombilla de repuesto (halogena)
 para mango de pila 85-0009

Lampe de rechange (halogène) pour
 poignée à piles 85-0009

Lampadina di ricambio (alogeno) per
 manico per pila 85-0009



85-0009
 16 cm, 6 1/4"

Batteriegriff ø 30 mm (2 Baby-Zellen,
 1,5 Volt, sind erforderlich)

Battery handle, ø 30 mm (2 Baby batteries,
 1,5 volt, are required)

Mango de pila ø 30 mm (se necesitan 2 pilas
 Mignon de 1,5 V)

Poignée à piles ø 30 mm (2 piles Mignon,
 1,5 volts sont nécessaires)

Manico per pila ø 30 mm (2 pile Mignon di
 1,5 volt sono necessarie)



MILLER Laryngoskope
 MILLER Laryngoscopes
 MILLER Laringoscopios
 MILLER Laryngoscopes
 MILLER Laringoscopi



1/3

MILLER 85-0045

Laryngoskopie-Besteck, bestehend aus:

- 85-0041 1 Laryngoskopie-Spatel 78/102 mm
- 85-0042 1 Laryngoskopie-Spatel 130/155 mm
- 85-0043 1 Laryngoskopie-Spatel 170/195 mm
- 85-0098 1 Batteriegriff ø 30 mm (ohne Batterien)
- 85-0047 1 Etui

Laryngoscope set, consisting of:

- 85-0041 1 Laryngoscope blade 78/102 mm
- 85-0042 1 Laryngoscope blade 130/155 mm
- 85-0043 1 Laryngoscope blade 170/195 mm
- 85-0098 1 Battery handle, ø 30 mm (without batteries)
- 85-0047 1 Case

Juego para laringoscopia, compuesto de:

- 85-0041 1 Espátula de laringoscopia 78/102 mm
- 85-0042 1 Espátula de laringoscopia 130/155 mm
- 85-0043 1 Espátula de laringoscopia 170/195 mm
- 85-0098 1 Mango de pila ø 30 mm (sin pilas)
- 85-0047 1 Estuche

Trousse à laryngoscopie, composée de:

- 85-0041 1 Spatule pour laryngoscopie 78/102 mm
- 85-0042 1 Spatule pour laryngoscopie 130/155 mm
- 85-0043 1 Spatule pour laryngoscopie 170/195 mm
- 85-0098 1 Poignée à piles ø 30 mm (sans piles)
- 85-0047 1 Boîte

Set per laringoscopia, composto da:

- 85-0041 1 Spatola per laringoscopia 78/102 mm
- 85-0042 1 Spatola per laringoscopia 130/155 mm
- 85-0043 1 Spatola per laringoscopia 170/195 mm
- 85-0098 1 Manico per pila ø 30 mm (senza pila)
- 85-0047 1 astuccio



1/3

MILLER 85-0046

Laryngoskopie-Besteck, bestehend aus:

- 85-0040 1 Laryngoskopie-Spatel 53/75 mm
- 85-0041 1 Laryngoskopie-Spatel 78/102 mm
- 85-0042 1 Laryngoskopie-Spatel 130/155 mm
- 85-0043 1 Laryngoskopie-Spatel 170/195 mm
- 85-0044 1 Laryngoskopie-Spatel 180/204 mm
- 85-0098 1 Batteriegriff ø 30 mm (ohne Batterien)
- 85-0048 1 Etui

Laryngoscope set, consisting of:

- 85-0040 1 Laryngoscope blade 53/75 mm
- 85-0041 1 Laryngoscope blade 78/102 mm
- 85-0042 1 Laryngoscope blade 130/155 mm
- 85-0043 1 Laryngoscope blade 170/195 mm
- 85-0044 1 Laryngoscope blade 180/204 mm
- 85-0098 1 Battery handle, ø 30 mm (without batteries)
- 85-0048 1 Case

Juego para laringoscopia, compuesto de:

- 85-0040 1 Espátula de laringoscopia 53/75 mm
- 85-0041 1 Espátula de laringoscopia 78/102 mm
- 85-0042 1 Espátula de laringoscopia 130/155 mm
- 85-0043 1 Espátula de laringoscopia 170/195 mm
- 85-0044 1 Espátula de laringoscopia 180/204 mm
- 85-0098 1 Mango de pila ø 30 mm (sin pilas)
- 85-0048 1 Estuche

Trousse à laryngoscopie, composée de:

- 85-0041 1 Spatule pour laryngoscopie 78/102 mm
- 85-0042 1 Spatule pour laryngoscopie 130/155 mm
- 85-0043 1 Spatule pour laryngoscopie 170/195 mm
- 85-0044 1 Spatule pour laryngoscopie 180/204 mm
- 85-0098 1 Poignée à piles ø 30 mm (sans piles)
- 85-0047 1 Boîte

Set per laringoscopia, composto da:

- 85-0041 1 Spatola per laringoscopia 78/102 mm
- 85-0042 1 Spatola per laringoscopia 130/155 mm
- 85-0043 1 Spatola per laringoscopia 170/195 mm
- 85-0044 1 Spatola per laringoscopia 180/204 mm
- 85-0098 1 Manico per pila ø 30 mm (senza pila)
- 85-0047 1 astuccio

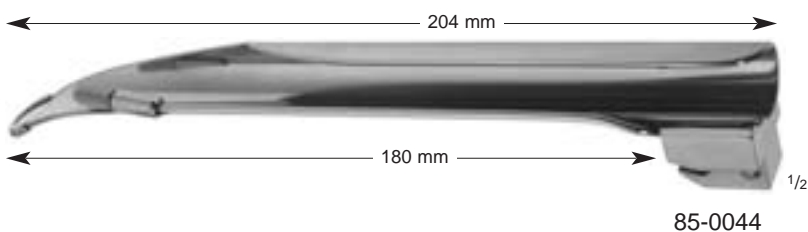
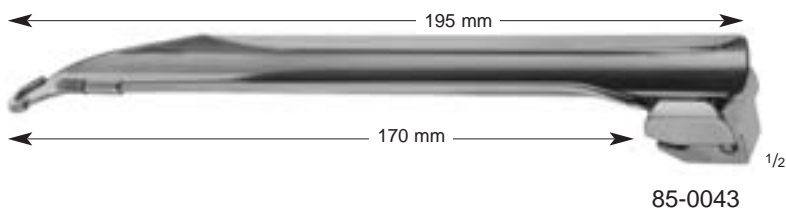
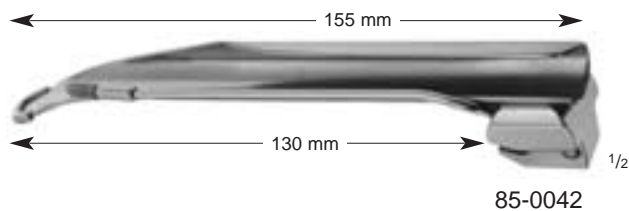
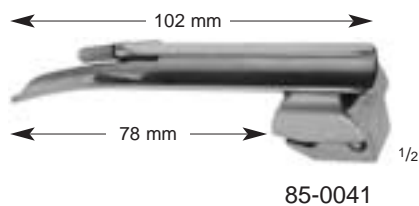
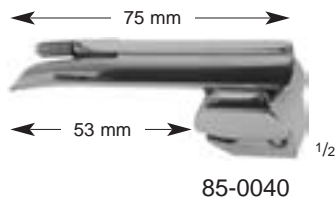
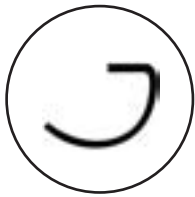

MILLER
 85-0040
 - 85-0044

Laryngoskopie-Spatel
 Laryngoscope blades
 Espátulas de laringoscopios
 Spatules de laryngoscopie
 Spatole per laringoscopi



85-0058
 2,5 V

Ersatzbirnchen für
 Laryngoskopie-Spatel
 85-0040 - 85-0043

Spare bulb for
 laryngoscope blades
 85-0040 - 85-0043

Bombilla de repuesto para
 espátulas de laringoscopios
 85-0040 - 85-0043

Lampe de rechange pour
 spatule de laryngoscope
 85-0040 - 85-0043

Lampadine di ricambio per
 spatola per laringoscopia
 85-0040 - 85-0043



85-0059
 2,5 V

Ersatzbirnchen für
 Laryngoskopie-Spatel
 85-0044

Spare bulb for
 laryngoscope blade
 85-0044

Bombilla de repuesto para
 espátula de laringoscopia
 85-0044

Lampe de rechange pour
 spatule de laryngoscope
 85-0044

Lampadine di ricambio per
 spatola per laringoscopia
 85-0044



85-0098
 14,5 cm, 5 3/4"

Batteriegriff ø 30 mm (2 Baby-
 Zellen, 1,5 Volt, sind erforderlich)

Battery handle, ø 30 mm (2 Baby
 batteries, 1.5 volt, are required)

Mango de pila ø 30 mm (se necesi-
 tan 2 pilas Mignon de 1,5 V)

Poignée à piles ø 30 mm (2 piles
 Mignon, 1,5 volts sont nécessaires)

Manico per pila ø 30 mm (2 pile
 Mignon di 1,5 volt sono necessarie)



85-0094
 15 cm, 6"

Batteriegriff ø 18 mm (2 Mini-
 Zellen, 1,5 Volt, sind erforderlich)

Battery handle, ø 18 mm (2 Mini
 batteries, 1.5 volt, are required)

Mango de pila ø 18 mm (se necesi-
 tan 2 pilas Mini de 1,5 V)

Poignée à piles ø 18 mm (2 piles
 Mini, 1,5 volts sont nécessaires)

Manico per pila ø 18 mm (2 pile
 Mini di 1,5 volt sono necessarie)



MILLER Laryngoskope mit Kaltlicht
 MILLER Laryngoscopes with Cold Light
 MILLER Laringoscopios de luz fría
 MILLER Laryngoscopes lumière froide
 MILLER Laringoscopi luce fredda



1/3

MILLER 85-0087

Laryngoskopie-Besteck, bestehend aus:

- 85-0082 1 Spatel mit Kaltlicht 78/102 mm
- 85-0083 1 Spatel mit Kaltlicht 130/155 mm
- 85-0084 1 Spatel mit Kaltlicht 170/195 mm
- 85-0009 1 Batteriegriff ø 30 mm (ohne Batterien)
- 85-0047 1 Etui

Laryngoscope set, consisting of:

- 85-0082 1 Blade with cold light 78/102 mm
- 85-0083 1 Blade with cold light 130/155 mm
- 85-0084 1 Blade with cold light 170/195 mm
- 85-0009 1 Battery handle, ø 30 mm (without batteries)
- 85-0047 1 Case

Juego para laringoscopia, compuesto de:

- 85-0082 1 Espátula con luz fría 78/102 mm
- 85-0083 1 Espátula con luz fría 130/155 mm
- 85-0084 1 Espátula con luz fría 170/195 mm
- 85-0009 1 Mango de pila ø 30 mm (sin pilas)
- 85-0047 1 Estuche

Trousse à laryngoscopie, composée de:

- 85-0082 1 Spatule lumière froide 78/102 mm
- 85-0083 1 Spatule lumière froide 130/155 mm
- 85-0084 1 Spatule lumière froide 170/195 mm
- 85-0009 1 Poignée à piles ø 30 mm (sans piles)
- 85-0047 1 Boîte

Set per laringoscopia, composto da:

- 85-0082 1 Spatola con luce fredda 78/102 mm
- 85-0083 1 Spatola con luce fredda 130/155 mm
- 85-0084 1 Spatola con luce fredda 170/195 mm
- 85-0009 1 Manico per pila ø 30 mm (senza pila)
- 85-0047 1 astuccio



1/3

MILLER 85-0088

Laryngoskopie-Besteck, bestehend aus:

- 85-0081 1 Spatel mit Kaltlicht 53/75 mm
- 85-0082 1 Spatel mit Kaltlicht 78/102 mm
- 85-0083 1 Spatel mit Kaltlicht 130/155 mm
- 85-0084 1 Spatel mit Kaltlicht 170/195 mm
- 85-0085 1 Spatel mit Kaltlicht 180/204 mm
- 85-0009 1 Batteriegriff ø 30 mm (ohne Batterien)
- 85-0048 1 Etui

Laryngoscope set, consisting of:

- 85-0081 1 Blade with cold light 53/75 mm
- 85-0082 1 Blade with cold light 78/102 mm
- 85-0083 1 Blade with cold light 130/155 mm
- 85-0084 1 Blade with cold light 170/195 mm
- 85-0085 1 Blade with cold light 180/204 mm
- 85-0009 1 Battery handle, ø 30 mm (without batteries)
- 85-0048 1 Case

Juego para laringoscopia, compuesto de:

- 85-0081 1 Espátula con luz fría 53/75 mm
- 85-0082 1 Espátula con luz fría 78/102 mm
- 85-0083 1 Espátula con luz fría 130/155 mm
- 85-0084 1 Espátula con luz fría 170/195 mm
- 85-0085 1 Espátula con luz fría 180/204 mm
- 85-0009 1 Mango de pila ø 30 mm (sin pilas)
- 85-0048 1 Estuche

Trousse à laryngoscopie, composée de:

- 85-0082 1 Spatule lumière froide 78/102 mm
- 85-0083 1 Spatule lumière froide 130/155 mm
- 85-0084 1 Spatule lumière froide 170/195 mm
- 85-0085 1 Spatule lumière froide 180/204 mm
- 85-0009 1 Poignée à piles ø 30 mm (sans piles)
- 85-0048 1 Boîte

Set per laringoscopia, composto da:

- 85-0082 1 Spatola con luce fredda 78/102 mm
- 85-0083 1 Spatola con luce fredda 130/155 mm
- 85-0084 1 Spatola con luce fredda 170/195 mm
- 85-0085 1 Spatola con luce fredda 180/204 mm
- 85-0009 1 Manico per pila ø 30 mm (senza pila)
- 85-0048 1 astuccio

MILLER Laryngoskope mit Kaltlicht
 MILLER Laryngoscopes with Cold Light
 MILLER Laringoscopios de luz fría
 MILLER Laryngoscopes lumière froide
 MILLER Laringoscopi luce fredda

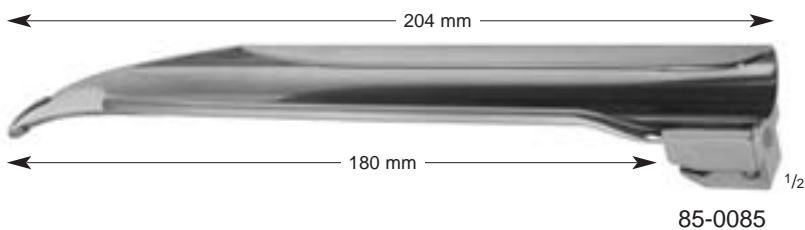
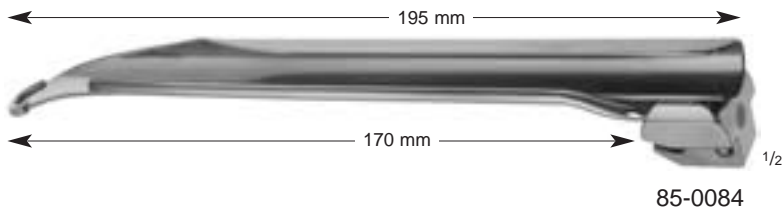
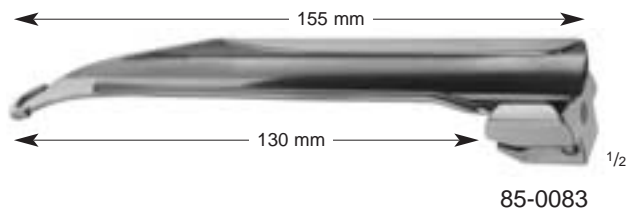
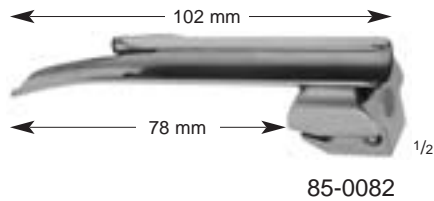
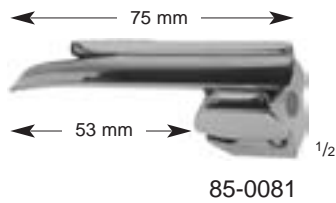
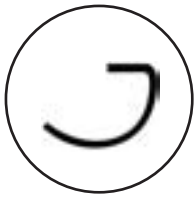

MILLER
 85-0081
 - 85-0085

Laryngoskopie-Spatel mit integriertem Kaltlichtträger
 Laryngoscope blades with integrated cold light carrier
 Espátulas de laringoscopios con luz fría integrada
 Spatules de laryngoscopie, avec lumière froide intégrée
 Spatole per laringoscopia, luce fredda



85-0008
 2,5 V

Ersatzbirnchen (Halogen) für Batteriegriff 85-0009

Spare bulb (Halogen) for battery handle 85-0009

Bombilla de repuesto (halogena) para mango de pila 85-0009

Lampe de recharge (halogène) pour poignée à piles 85-0009

Lampadina di ricambio (alogeno) per manico per pila 85-0009



85-0009
 16 cm, 6 1/4"

Batteriegriff ø 30 mm (2 Baby-Zellen, 1,5 Volt, sind erforderlich)

Battery handle, ø 30 mm (2 Baby batteries, 1,5 volt, are required)

Mango de pila ø 30 mm (se necesitan 2 pilas Mignon de 1,5 V)

Poignée à piles ø 30 mm (2 piles Mignon, 1,5 volts sont nécessaires)

Manico per pila ø 30 mm (2 pile Mignon di 1,5 volt sono necessarie)



Katheter-Einführungszangen
Catheter Introducing Forceps
Pinzas para introducir catéteres
Pinces pour intubation
Pinze introduttrici di cateteri

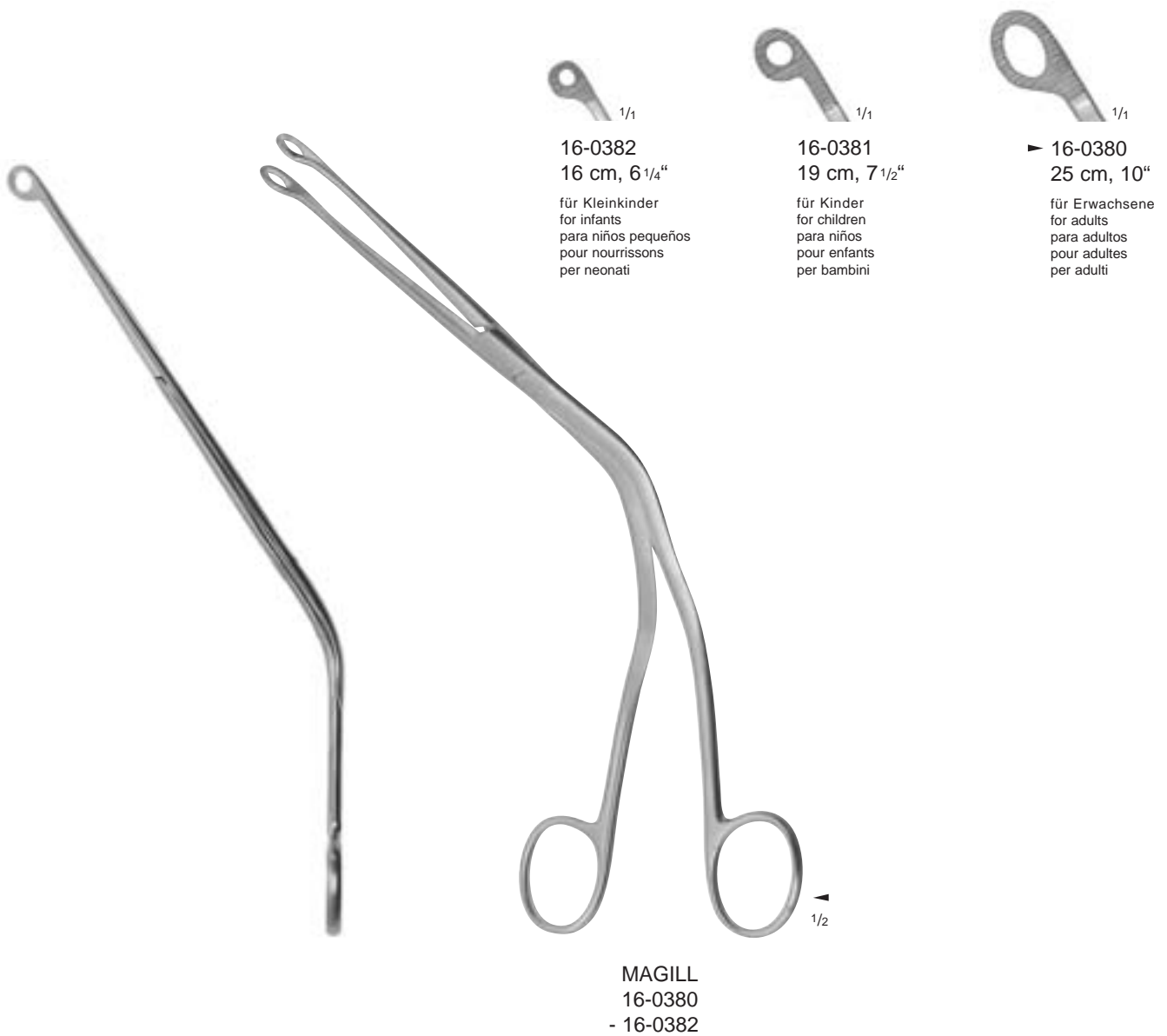



LAWNTON

Medizintechnik



Skalpelle, Messer
Scalpels, Knives
Bisturíes, Cuchillos
Bistouris, Couteaux
Bisturi, Coltelli



Sterile Skalpellklingen
Sterile Scalpel Blades
Hojas de bisturíes, estériles
Lames de bistouris, stériles
Lame per bisturi, sterili

Skalpellgriffe
Scalpel Handles
Mangos de bisturíes
Manches pour bistouris
Manici per bisturi



1/1

Fig. 10

04-1010



1/1

Fig. 11

04-1011



1/1

Fig. 12

04-1012



1/1

Fig. 13

04-1013



1/1

Fig. 15

04-1015



1/1

Fig. 12d

04-1112

doppelschneidig
double cutting edges
filo doble
double tranchant
filo doppio

in Packungen zu 100 Stück • in packages of 100 pieces • en paquetes de 100 piezas • en paquets de 100 pièces • in confezioni di 100 pezzi



1/2

No. 3

04-1050
12 cm, 4 3/4"



1/2

No. 3L

04-1051
21 cm, 8 1/4"

gerade
straight
recto
droit
retto



1/2

No. 3L

04-1059
20,5 cm, 8"

abgewinkelt
angled
acodado
coudé
angolato



1/1



1/2

No. 7

04-1057
16 cm, 6 1/4"



1/2

No. 7L

04-1058
22 cm, 8 3/4"

Sterile Skalpellklingen
 Sterile Scalpel Blades
 Hojas de bisturíes, estériles
 Lames de bistouris, stériles
 Lame per bisturi, sterili

Skalpellgriffe
 Scalpel Handles
 Mangos de bisturíes
 Manches pour bistouris
 Manici per bisturi



1/1

Fig. 18

04-1018



1/1

Fig. 20

04-1020



1/1

Fig. 21

04-1021



1/1

Fig. 22

04-1022



1/1

Fig. 23

04-1023



1/1

Fig. 24

04-1024

in Packungen zu 100 Stück • in packages of 100 pieces • en paquets de 100 piezas • en paquets de 100 pièces • in confezioni di 100 pezzi



1/1

Fig. 25

04-1025



1/1

Fig. 36d

04-1136

doppelschneidig
 double cutting edges
 filo doble
 double tranchant
 filo doppio



1/2

No. 4

04-1055
 13 cm, 5 1/8"



1/2

No. 4L

04-1056
 21 cm, 8 1/4"



Klingen
Blades
Hojas
Lames
Lamette

Rasierklingen-Halter und -Brecher
Razor Blade Holders and Breakers
Pinzas para sujetar y romper hojas de afeitarse
Pincettes pour saisir et casser les lames de rasoir
Pinze per afferrare e rompere le lamette de rasoio

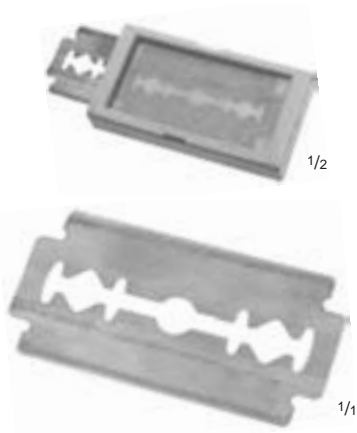

60-1780

Rasierklingen, brechbar, rostfrei, in Packungen zu 10 Stück

Razor blades, breakable, stainless steel, in packages of 10 pieces

Hojas de afeitarse, rompibles de acero inoxidable, en paquetes de 10 piezas

Lames de rasoir, cassables, en inox, en paquets de 10

Lamette di rasoio, per rompere, acciaio inossidabile, scatola di 10 pezzi



TROUTMAN 60-1793 9 cm, 3 1/2"

Rasierklingen-Halter und -Brecher
Razor blade holder and breaker
Pinza para sujetar y romper hojas de afeitarse
Pincette pour saisir et casser les lames de rasoir
Pinza per afferrare e rompere le lamette da rasoio

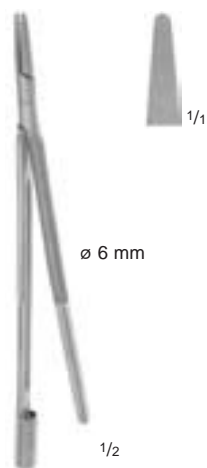

CASTROVIEJO 60-1797 12 cm, 4 3/4"

Rasierklingen-Halter und -Brecher
Razor blade holder and breaker
Pinza para sujetar y romper hojas de afeitarse
Pincette pour saisir et casser les lames de rasoir
Pinza per afferrare e rompere le lamette da rasoio



CASTROVIEJO 60-1791 13,5 cm, 5 1/4"

Rasierklingen-Halter und -Brecher
Razor blade holder and breaker
Pinza para sujetar y romper hojas de afeitarse
Pincette pour saisir et casser les lames de rasoir
Pinza per afferrare e rompere le lamette da rasoio

Nasenplastikmesser
 Rhinoplastic Knives
 Bisturíes para rinoplastia
 Bistouris pour plastie du nez
 Bisturi per rino plastica

Tenotom
 Tenotome
 Tenotomo
 Ténotome
 Tenotomo

Duramesser
 Dura Knives
 Cuchillos p. dura-madré
 Couteaux pour dure-mère
 Coltelli per dura-madre

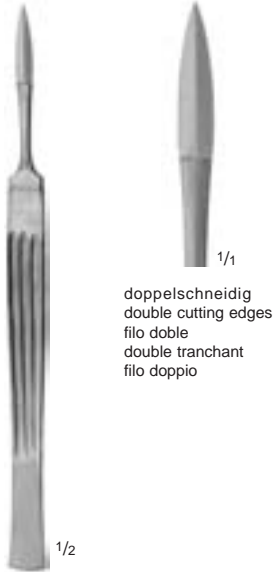

doppelschneidig
 double cutting edges
 filo doble
 double tranchant
 filo doppio

JOSEPH
 75-0100
 15 cm, 6"

Nasenplastikmesser
 Rhinoplastic knife
 Bisturí para rinoplastia
 Bistouri pour plastie du nez
 Bisturi per rinoplastica



doppelschneidig
 double cutting edges
 filo doble
 double tranchant
 filo doppio

04-1225
 16,5 cm, 6 1/2"

Nasenplastikmesser
 Rhinoplastic knife
 Bisturí para rinoplastia
 Bistouri pour plastie du nez
 Bisturi per rinoplastica



04-1228
 16,5 cm, 6 1/2"

Tenotom
 Tenotome
 Tenotomo
 Ténotome
 Tenotomo



TÖNNIS
 04-1250
 12,5 cm, 5"

Duramesser
 Dura knife
 Cuchillo para dura-madré
 Couteau pour dure-mère
 Coltello per dura-madre



TÖNNIS
 04-1252
 20,5 cm, 8"

Duramesser
 Dura knife
 Cuchillo para dura-madré
 Couteau pour dure-mère
 Coltello per dura-madre



HALLE
 04-1260
 21 cm, 8 1/4"

Duramesser
 Dura knife
 Cuchillo para dura-madré
 Couteau pour dure-mère
 Coltello per dura-madre



ULRICH
 04-1270
 22,5 cm, 9"

Fistelmesser
 Fistula knife
 Cuchillo para fistulas
 Bistouri pour fistules
 Bisturi per fistole



Resektionsmesser
Resection Knives
Cuchillos para resección
Couteaux à résection
Coltelli per resezione

Amputationsmesser
Amputation Knives
Cuchillos para amputación
Couteaux à amputation
Coltelli per amputazione



LANGENBECK
47-0262
55 mm

Resektionsmesser
Resection knife
Cuchillo para resección
Couteau à résection
Coltello per resezione



LANGENBECK
47-0263
55 mm

Resektionsmesser
Resection knife
Cuchillo para resección
Couteau à résection
Coltello per resezione

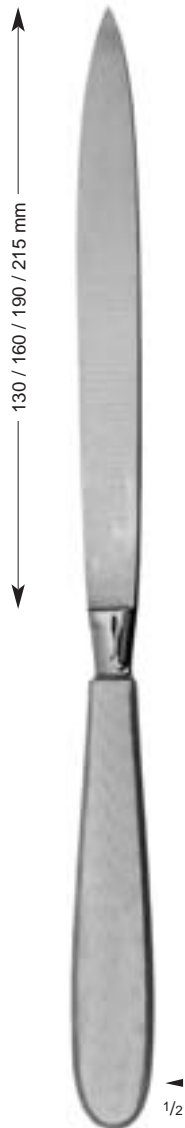

LISTON
47-0250 130 mm
▶ 47-0251 160 mm
47-0252 190 mm
47-0254 215 mm

Amputationsmesser
Amputation knives
Cuchillos para amputación
Couteau à amputation
Coltello per amputazione

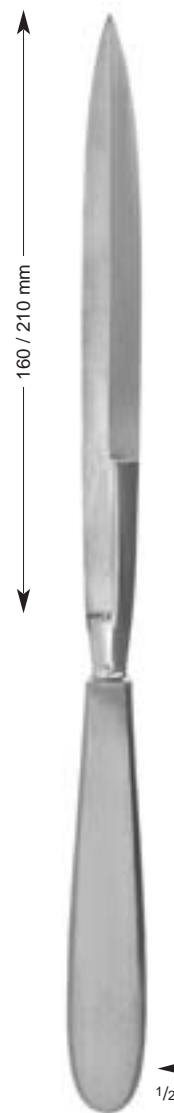

CATLIN
▶ 47-0255 160 mm
47-0256 210 mm

Amputationsmesser,
doppelschneidig
Amputation knives,
double cutting edges
Cuchillos para amputación,
filo doble
Couteau à amputation,
double tranchant
Coltello per amputazione,
filo doppio



47-0265
65 mm

Beinhautmesser
mit Schaber
 Periosteum knife
with raspatory
 Cuchillo para periostio,
con periostótomio
 Couteau à périoste
avec râpe
 Coltell per periostio
con raschiatoio

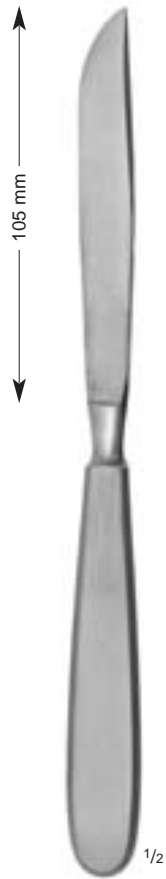

47-0264
105 mm

Phalangenmesser
Phalangeal knife
Cuchillo para falanges
Couteau à phalanges
Coltello per falangi

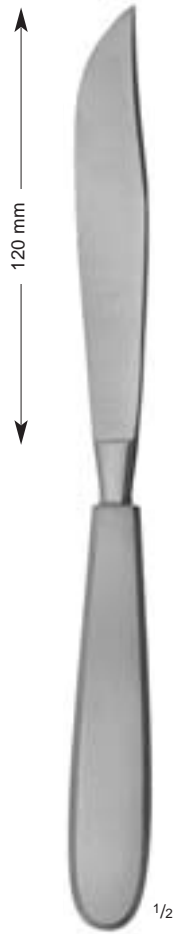

LANGENBECK
47-0260
120 mm

Lappenmesser
Flap knife
Cuchillo para lóbulos
Couteau à lobe
Coltello per lobi

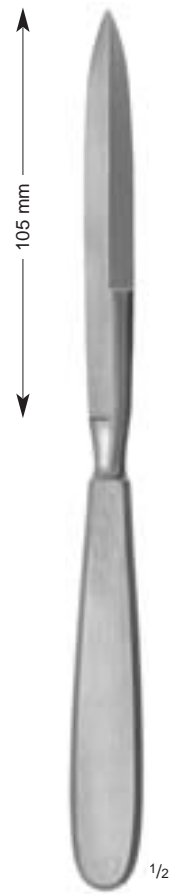

47-0266
105 mm

Zwischenknochenmesser,
doppelschneidig
 Interosseos knife,
double cutting edges
 Cuchillo interóseo,
filo doble
 Couteau interosseux,
double tranchant
 Coltello interosseo,
filo doppio



Messer für Autopsie
 Post Mortem Knives
 Cuchillos para autopsia
 Bistouris à autopsie
 Coltello per autopsia

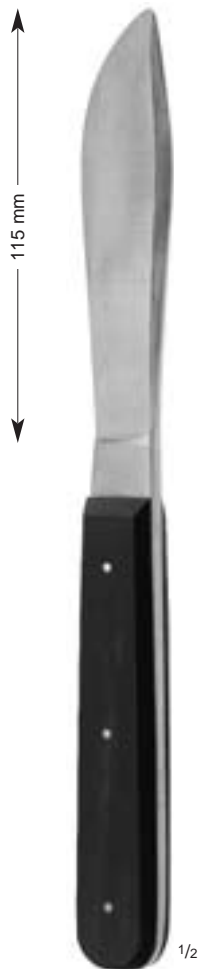

04-1352
 115 mm

Seziermesser mit Holzheft
 Autopsy knife with wooden handle
 Cuchillo para autopsia, con mango de madera
 Bistouri à autopsie, manche en bois
 Coltello per autopsia con manico in legno

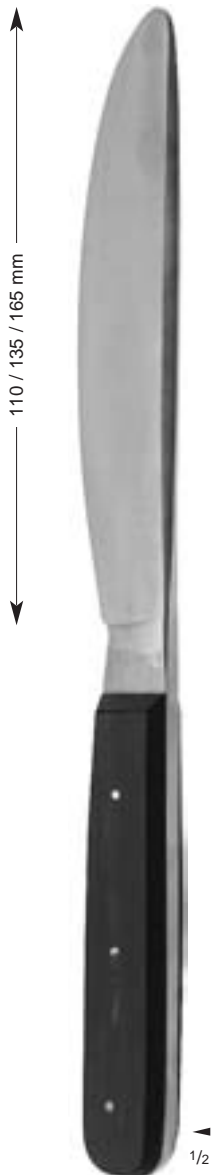

WALB
 04-1355 110 mm
 04-1356 135 mm
 ▶ 04-1357 165 mm

Organmesser mit Holzheft
 Post mortem knives with wooden handle
 Cuchillos post mortem, con mango de madera
 Couteaux à autopsie, manche en bois
 Coltello per autopsia con manico in legno

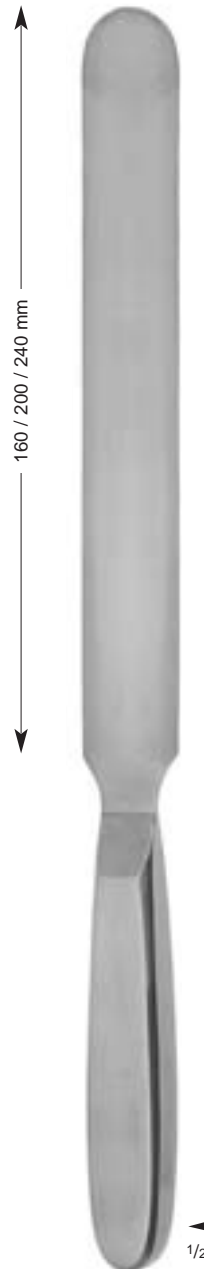

VIRCHOW
 04-1360 160 mm
 ▶ 04-1361 200 mm
 04-1362 240 mm

Hirnmesser mit Metallheft
 Brain knives with metal handle
 Cuchillos para cerebro, con mango de metal
 Couteaux à cerveau, manche métal
 Coltello per il cervello con manico in metallo



SILVER
 04-1385
 19,5 cm, 7³/₄"

Dermatom für handelsübliche Rasierklingen
 Dermatome for razor blades standard model in trade
 Dermátomo para hojas de afeitar corrientes
 Dermatome pour lames de rasoir standard
 Dermatomo per lame di rasoio standard



SCHINK
 04-1390
 30 cm, 12"

Dermatom, einstellbar von 0,1 bis 2,0 mm (maximale Breite des Hautlappens: 100 mm, 4"), komplett, mit 1 auswechselbaren Klinge und 2 Haut-Spannplatten

Dermatome, adjustable from 0.1 to 2.0 mm (maximum width of skin graft: 100 mm, 4"), complete, with 1 interchangeable blade and 2 skin straightening plates

Dermátomo, graduable de 0,1 hasta 2,0 mm (anchura máx. de injerto cataneo: 100 mm, 4"), completo, con 1 hoja intercambiable y placas para extender la piel

Dermatome réglable de 0,1 à 2,0 mm, épaisseur (maximale du greffon: 100 mm, 4") complet avec une lame interchangeable et 2 plaques pour tendre la peau

Dermatomo regolabile da 0,1 a 2,0 mm (larghezza massima del taglio: mm 100, 4") completo di 1 lama intercambiabile e 2 placche per stendere la pelle



04-1391

Ersatzklinge allein
 Spare blade only
 Hoja de repuesto, suelta
 Lame de rechange seule
 Lama di ricambio, sola



04-1392

Haut-Spannplatte allein
 Skin straightening plate only
 Placa para extender la piel, suelta
 Plaque pour tendre la peau seule
 Placca per stendere la pelle, sola



Dermatom
Dermatome
Dermátomo
Dermatome
Dermatomo



1/2



1/2

04-1396

Ersatzklinge allein
Spare blade only
Hoja de repuesto, suelta
Lame de rechange seule
Lama di ricambio

HUMBY

04-1395

32 cm, 12 1/2"

Dermatom, einstellbar von 0,1 bis 1,5 mm (maximale Breite des Hautlappens : 150 mm, 6"), komplett mit 1 auswechselbaren Klinge
Dermatome, adjustable from 0.1 to 1.5 mm (maximum width of skin graft: 150 mm, 6"), complete, with 1 interchangeable blade
Dermátomo, graduable de 0,1 hasta 1,5 mm (anchura máx. de injerto cutáneo: 150 mm, 6"), completo, con 1 hoja intercambiable
Dermatome réglable de 0,1 à 1,5 mm, épaisseur (maximale du greffon: 150 mm, 6") complet avec une lame interchangeable
Dermatomo regolabile da 0,1 a 1,5 mm (larghezza massima del taglio: mm 150, 6") completo di 1 lama intercambiabile



LAWNTON

Medizintechnik

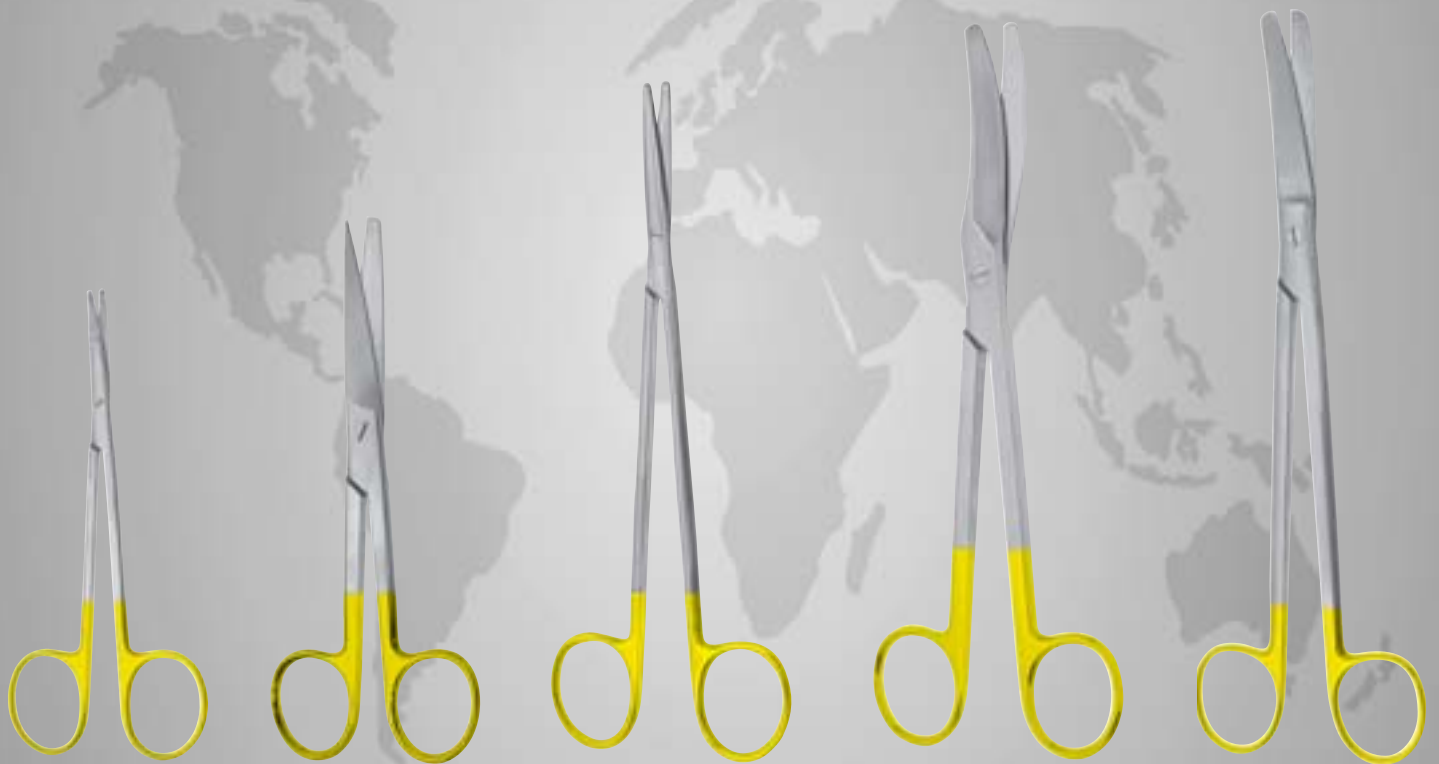

- DURACUT® Scheren
- DURACUT® Scissors
- DURACUT® Tijeras
- DURACUT® Ciseaux
- DURACUT® Forbici

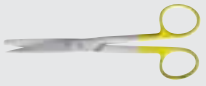

DURACUT® Scheren mit Hartmetallschneiden
DURACUT® Scissors with tungsten carbide edges
DURACUT® Tijeras con filos de carburo tungsteno
DURACUT® Ciseaux avec des lames en tungstène
DURACUT® Forbici con lame in carburo di tungsteno



- In der Marke DURACUT® spiegelt sich die längste Erfahrung in der Herstellung von Scheren mit aufgeschweißten Hartmetallschneiden wider. Vorteile:
 - dauerhafte Schnitthaltigkeit
 - weicher, gleichmäßiger Gang
 - vergoldete Griffe als leichte Kennzeichnung
- The name DURACUT® reflects longest experience in producing scissors with welded hard faced cutting edges. Advantages:
 - longer lasting cut
 - smooth and regular cutting
 - golden handles for easy identification
- La marca DURACUT® refleja la experiencia más avanzada en la producción de las tijeras con los filos de carburo tungsteno fundidos. Ventajas:
 - duración de la agudeza
 - corte suave y regular
 - mangos dorados para su identificación
- La marque DURACUT® reflète l'expérience la plus longue qui soit dans le domaine de la fabrication de ciseaux à lames de métal dur soudées. Avantages:
 - excellente tenue de coupe
 - souplesse et régularité de manoeuvre
 - anneaux dorés pour une identification facile
- Nella marca DURACUT® si riflette una lunga esperienza nella produzione di forbici con lame in carburo metallico saldate. I vantaggi:
 - maggior durata delle lame
 - taglio morbido e regolare
 - impugnatura dorata per una facile identificazione

DURACUT® Feine Scheren mit Hartmetallschneiden
 DURACUT® Delicate Scissors with tungsten carbide edges
 DURACUT® Tijeras finas con filos de carburo tungsteno
 DURACUT® Ciseaux fins avec des lames en tungstène
 DURACUT® Forbici fini con lame in carburo di tungsteno



► 05-1450
11,5 cm, 4 1/2"

05-1455
11,5 cm, 4 1/2"

05-1450
- 05-1455

Irisscheren
Iris scissors
Tijeras para iridectomía
Ciseaux à iridectomie
Forbici per iridectomia



05-1459
11 cm, 4 3/8"

Irisschere
Iris scissors
Tijera para iridectomia
Ciseaux à iridectomie
Forbici per iridectomia



► 05-1460
14 cm, 5 1/2"

05-1461
14 cm, 5 1/2"

JOSEPH
05-1460
- 05-1461

Scheren für plastische Chirurgie
Plastic surgery scissors
Tijeras para la cirugía plástica
Ciseaux pour la chirurgie plastique
Forbici per la chirurgia plastica



► 05-1480
16 cm, 6 1/4"

05-1481
16 cm, 6 1/4"

KELLY
05-1480
- 05-1481

Gefäß- und Fistelscheren
Vascular and fistula scissors
Tijeras para vasos y fistulas
Ciseaux vasculaires et pour fistules
Forbici vascolare e per fistole



DURACUT® Chirurgische Scheren mit Hartmetallschneiden
 DURACUT® Surgical Scissors with tungsten carbide edges
 DURACUT® Tijeras para cirugía con filos de carburo tungsteno
 DURACUT® Ciseaux à chirurgie avec des lames en tungstène
 DURACUT® Forbici per chirurgia con lame in carburo di tungsteno



► 05-1501
14,5 cm, 5³/₄"



► 05-1500
14,5 cm, 5³/₄"



► 05-1504
14,5 cm, 5³/₄"



05-1503
14,5 cm, 5³/₄"



05-1502
14,5 cm, 5³/₄"



05-1505
14,5 cm, 5³/₄"

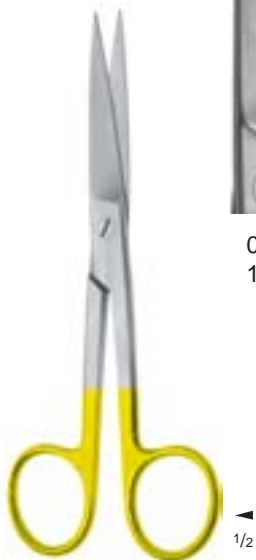

05-1501
- 05-1503

Standard Modelle
Standard patterns
modelos standard
modèles standard
modelli standard



05-1500
- 05-1502

Standard Modelle
Standard patterns
modelos standard
modèles standard
modelli standard



05-1504
- 05-1505

Standard Modelle
Standard patterns
modelos standard
modèles standard
modelli standard

DURACUT® Präparierscheren mit Hartmetallschneiden
 DURACUT® Dissecting Scissors with tungsten carbide edges
 DURACUT® Tijeras de disección con filos de carburo tungsteno
 DURACUT® Ciseaux à dissection avec des lames en tungstène
 DURACUT® Forbici per dissezione con lame in carburo di tungsteno



05-1550
14,5 cm, 5^{3/4}"



▶ 05-1560
17 cm, 6^{3/4}"



05-1570
23 cm, 9"



MAYO
05-1550
- 05-1571



05-1551
14,5 cm, 5^{3/4}"



05-1561
17 cm, 6^{3/4}"



05-1571
23 cm, 9"



DURACUT® Präparierscheren mit Hartmetallschneiden
DURACUT® Dissecting Scissors with tungsten carbide edges
DURACUT® Tijeras de disección con filos de carburo tungsteno
DURACUT® Ciseaux à dissection avec des lames en tungstène
DURACUT® Forbici per dissezione con lame in carburo di tungsteno

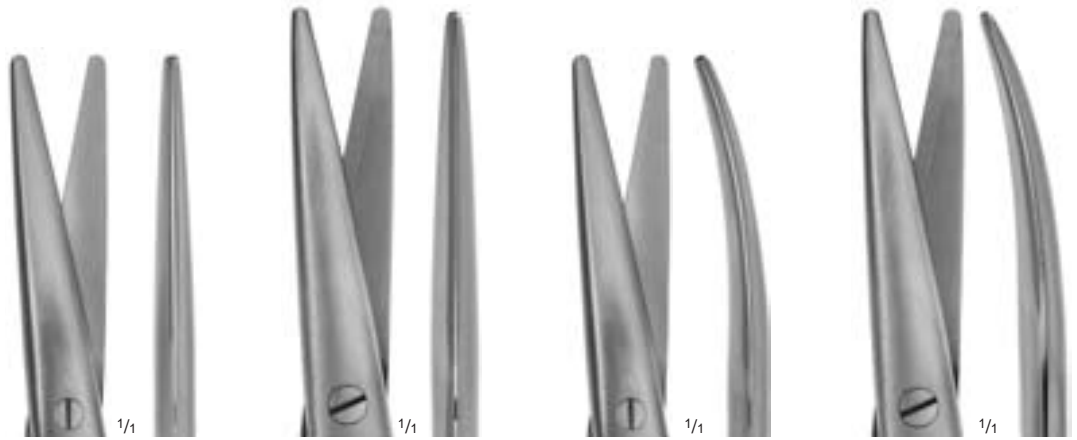

► 05-1555
14,5 cm, 5³/₄"

05-1565
17 cm, 6³/₄"

05-1556
14,5 cm, 5³/₄"

05-1566
17 cm, 6³/₄"

MAYO-STILLE
05-1555
- 05-1566



► 05-1580
16 cm, 6¹/₄"

05-1582
21 cm, 8¹/₄"

05-1581
16 cm, 6¹/₄"

05-1583
21 cm, 8¹/₄"

MAYO-LEXER
05-1580
- 05-1583

DURACUT® Präparierscheren mit Hartmetallschneiden
 DURACUT® Dissecting Scissors with tungsten carbide edges
 DURACUT® Tijeras de disección con filos de carburo tungsteno
 DURACUT® Ciseaux à dissection avec des lames en tungstène
 DURACUT® Forbici per dissezione con lame in carburo di tungsteno



RAGNELL
 05-1491
 12,5 cm, 5"



LEXER
 05-1584
 - 05-1585



► 05-1584
 16 cm, 6 1/4"



05-1585
 16 cm, 6 1/4"



TOENNIS-ADSON
 05-1579
 17,5 cm, 7"



METZENBAUM
 05-1465
 - 05-1466



► 05-1465
 11,5 cm, 4 1/2"



05-1466
 11,5 cm, 4 1/2"



DURACUT® Präparierscheren mit Hartmetallschneiden
 DURACUT® Dissecting Scissors with tungsten carbide edges
 DURACUT® Tijeras de disección con filos de carburo tungsteno
 DURACUT® Ciseaux à dissection avec des lames en tungstène
 DURACUT® Forbici per dissezione con lame in carburo di tungsteno



05-2000
14,5 cm, 5³/₄"



▶ 05-2002
18 cm, 7"



05-2004
20,5 cm, 8"



05-2006
23 cm, 9"



05-2001
14,5 cm, 5³/₄"



05-2003
18 cm, 7"



05-2005
20,5 cm, 8"



05-2007
23 cm, 9"

METZENBAUM
 05-2000
 - 05-2007

Standard Modelle
 Standard patterns
 modelos standard
 modèles standard
 modelli standard

DURACUT® Präparierscheren mit Hartmetallschneiden
 DURACUT® Dissecting Scissors with tungsten carbide edges
 DURACUT® Tijeras de disección con filos de carburo tungsteno
 DURACUT® Ciseaux à dissection avec des lames en tungstène
 DURACUT® Forbici per dissezione con lame in carburo di tungsteno

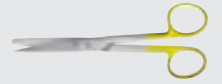

05-2010
14,5 cm, 5 3/4"



▶ 05-2020
18 cm, 7"



05-2040
20,5 cm, 8"



05-2060
23 cm, 9"



METZENBAUM
05-2010
- 05-2062

feine Modelle
delicate patterns
modelos finos
modèles fins
modelli delicati



05-2012
14,5 cm, 5 3/4"



05-2022
18 cm, 7"



05-2042
20,5 cm, 8"



05-2062
23 cm, 9"



DURACUT® Präparierscheren mit Hartmetallschneiden
DURACUT® Dissecting Scissors with tungsten carbide edges
DURACUT® Tijeras de disección con filos de carburo tungsteno
DURACUT® Ciseaux à dissection avec des lames en tungstène
DURACUT® Forbici per dissezione con lame in carburo di tungsteno



05-2011
14,5 cm, 5³/₄"



▶ 05-2021
18 cm, 7"



05-2041
20,5 cm, 8"



05-2061
23 cm, 9"



05-2013
14,5 cm, 5³/₄"



05-2023
18 cm, 7"



05-2043
20,5 cm, 8"



05-2063
23 cm, 9"



METZENBAUM
05-2011
- 05-2063

sehr feine Modelle
very delicate patterns
modelos muy finos
modèles très fins
modelli molto delicati

DURACUT® Präparierscheren mit Hartmetallschneiden
 DURACUT® Dissecting Scissors with tungsten carbide edges
 DURACUT® Tijeras de disección con filos de carburo tungsteno
 DURACUT® Ciseaux à dissection avec des lames en tungstène
 DURACUT® Forbici per dissezione con lame in carburo di tungsteno



► 05-2072 26,0 cm, 10 1/4"
 05-2074 28,5 cm, 11 1/4"



05-2076
 31 cm, 12 1/4"



► 05-2082 26,0 cm, 10 1/4"
 05-2084 28,5 cm, 11 1/4"



05-2073 26,0 cm, 10 1/4"
 05-2075 28,5 cm, 11 1/4"



05-2077
 31 cm, 12 1/4"



05-2083 26,0 cm, 10 1/4"
 05-2085 28,5 cm, 11 1/4"



NELSON-METZENBAUM
 05-2072
 - 05-2077

Standard Modelle
 Standard patterns
 modelos standard
 modèles standard
 modelli standard



NELSON-METZENBAUM
 05-2082
 - 05-2085

feine Modelle
 delicate patterns
 modelos finos
 modèles fins
 modelli delicati



DURACUT® Scheren mit Hartmetallschneiden
DURACUT® Scissors with tungsten carbide edges
DURACUT® Tijeras con filos de carburo tungsteno
DURACUT® Ciseaux avec des lames en tungstène
DURACUT® Forbici con lame in carburo di tungsteno



METZENBAUM
05-2064
- 05-2068



▶ 05-2064
18 cm, 7"



05-2066
20,5 cm, 8"



05-2068
23 cm, 9"

Präparierscheren • Dissecting scissors • Tijeras de disección • Ciseaux à dissection • Forbici per dissezione



METZENBAUM-THOREK
05-1656
- 05-1658



▶ 05-1656
20 cm, 8"



05-1658
22,5 cm, 9"



05-1657
27,5 cm, 10³/₄"

Adnexscheren • Adnex scissors • Tijeras adnex • Ciseaux adnex • Forbici adnex

DURACUT® Zahnfleischscheren mit Hartmetallschneiden
 DURACUT® Gum Scissors with tungsten carbide edges
 DURACUT® Tijeras para encías con filos de carburo tungsteno
 DURACUT® Ciseaux pour gencive avec des lames en tungstène
 DURACUT® Forbici per gengiva con lame in carburo di tungsteno



► 05-1470
13 cm, 5 1/8"

05-1471
13 cm, 5 1/8"

◄ 1/2

GOLDMANN-FOX
05-1470
- 05-1471

► 05-1476
13 cm, 5 1/8"

05-1477
13 cm, 5 1/8"

◄ 1/2

GOLDMANN-FOX
05-1476
- 05-1477

1 Blatt gezahnt
1 blade serrated
1 hoja dentada
1 lame dentelée
1 lama dentata

1 Blatt gezahnt
1 blade serrated
1 hoja dentada
1 lame dentelée
1 lama dentata

◄ 1/2

LOCKLIN
05-1472
16 cm, 6 1/4"

1 Blatt gezahnt
1 blade serrated
1 hoja dentada
1 lame dentelée
1 lama dentata

◄ 1/2

LOCKLIN
05-1473
16 cm, 6 1/4"

1 Blatt gezahnt
1 blade serrated
1 hoja dentada
1 lame dentelée
1 lama dentata

◄ 1/2

DEAN
05-1474
17 cm, 6 3/4"



DURACUT® Gefäßscheren mit Hartmetallschneiden
 DURACUT® Vascular Scissors with tungsten carbide edges
 DURACUT® Tijeras vasculares con filos de carburo tungsteno
 DURACUT® Ciseaux vasculaires avec des lames en tungstène
 DURACUT® Forbici vascolari con lame in carburo di tungsteno



30-2070
18 cm, 7"



▶ 30-2071
18 cm, 7"

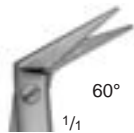

30-2072
17,5 cm, 7"

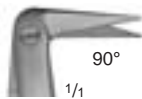

30-2073
17 cm, 6 3/4"



30-2074
17 cm, 6 3/4"



HEGEMANN-DIETRICH
30-2070
- 30-2074



30-2000
19 cm, 7 1/2"



30-2001
18,5 cm, 7 1/4"



▶ 30-2002
18 cm, 7"



POTTS-SMITH
30-2000
- 30-2002

DURACUT® Gefäßscheren mit Hartmetallschneiden
 DURACUT® Vascular Scissors with tungsten carbide edges
 DURACUT® Tijeras vasculares con filos de carburo tungsteno
 DURACUT® Ciseaux vasculaires avec des lames en tungstène
 DURACUT® Forbici vascolari con lame in carburo di tungsteno



▶ 30-2005
19 cm, 7 1/2"



▶ 30-2010
23 cm, 9"



30-2006
18,5 cm, 7 1/4"



30-2011
22,5 cm, 9"

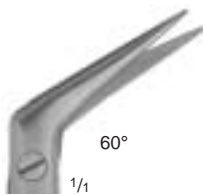

30-2007
18 cm, 7"



30-2012
22 cm, 8 3/4"



DE BAKEY
30-2005
- 30-2007



DE BAKEY
30-2010
- 30-2012



DURACUT® Nasenscheren mit Hartmetallschneiden
DURACUT® Nasal Scissors with tungsten carbide edges
DURACUT® Tijeras nasales con filos de carburo tungsteno
DURACUT® Ciseaux nasaux avec des lames en tungstène
DURACUT® Forbici nasali con lame in carburo di tungsteno



1 Blatt gezahnt
1 blade serrated
1 hoja dentada
1 lame dentelée
1 lama dentata

KNIGHT
05-1664
17,5 cm, 7"



1 Blatt gezahnt
1 blade serrated
1 hoja dentada
1 lame dentelée
1 lama dentata

HEYMANN
05-1666
18,5 cm, 7 1/4"



1 Blatt gezahnt
1 blade serrated
1 hoja dentada
1 lame dentelée
1 lama dentata

FOMON
05-1660
13,5 cm, 5 1/4"



1 Blatt gezahnt
1 blade serrated
1 hoja dentada
1 lame dentelée
1 lama dentata

COTTLE
05-1662
16 cm, 6 1/4"

DURACUT® Scheren mit Hartmetallschneiden
 DURACUT® Scissors with tungsten carbide edges
 DURACUT® Tijeras con filos de carburo tungsteno
 DURACUT® Ciseaux avec des lames en tungstène
 DURACUT® Forbici con lame in carburo di tungsteno



CAPLAN
 05-1668
 20 cm, 8"

Septumschere, gezahnt
 Septum scissors, serrated
 Tijera para el tabique nasal, dentada
 Ciseaux dentelés pour septum
 Forbici per il setto nasale, dentate

1/2

1/1



BLESSING
 05-1600
 30 cm, 12"

Schere für die Rektumchirurgie. Die stumpfe Form erleichtert das Präparieren in der richtigen Schicht, wodurch das präsakrale Nervengeflecht besser geschont werden kann.

Scissors for rectal surgery. The blunt shape facilitates the preparation of the correct layer, so that the presacral neuroplexus can be better preserved.

Tijera para la cirugía del recto. La forma roma facilita la preparación en la película precisa, por la cual se puede preservar mejor el neuroplexus presacral.

Ciseaux pour la chirurgie rectale. Sa forme émoussée facilite la dissection dans la bonne épaisseur et permet ainsi de mieux ménager le plexus pré-sacré.

Forbici per la chirurgia rettale. La forma smussata permette un facile incanalamento durante la dissezione senza ledere e meglio proteggendo il plesso nervoso sacrale.

1/1

1/2



GORNEY
 05-1670
 21,5 cm, 8 1/2"

Septumschere, gezahnt
 Septum scissors, serrated
 Tijera para el tabique nasal, dentada
 Ciseaux dentelés pour septum
 Forbici per il setto nasale, dentate

1/2

1/1



DURACUT® Gynäkologische Scheren mit Hartmetallschneiden
 DURACUT® Gynecological Scissors with tungsten carbide edges
 DURACUT® Tijeras para ginecología con filos de carburo tungsteno
 DURACUT® Ciseaux pour gynécologie avec des lames en tungstène
 DURACUT® Forbici per ginecologia con lame in carburo di tungsteno

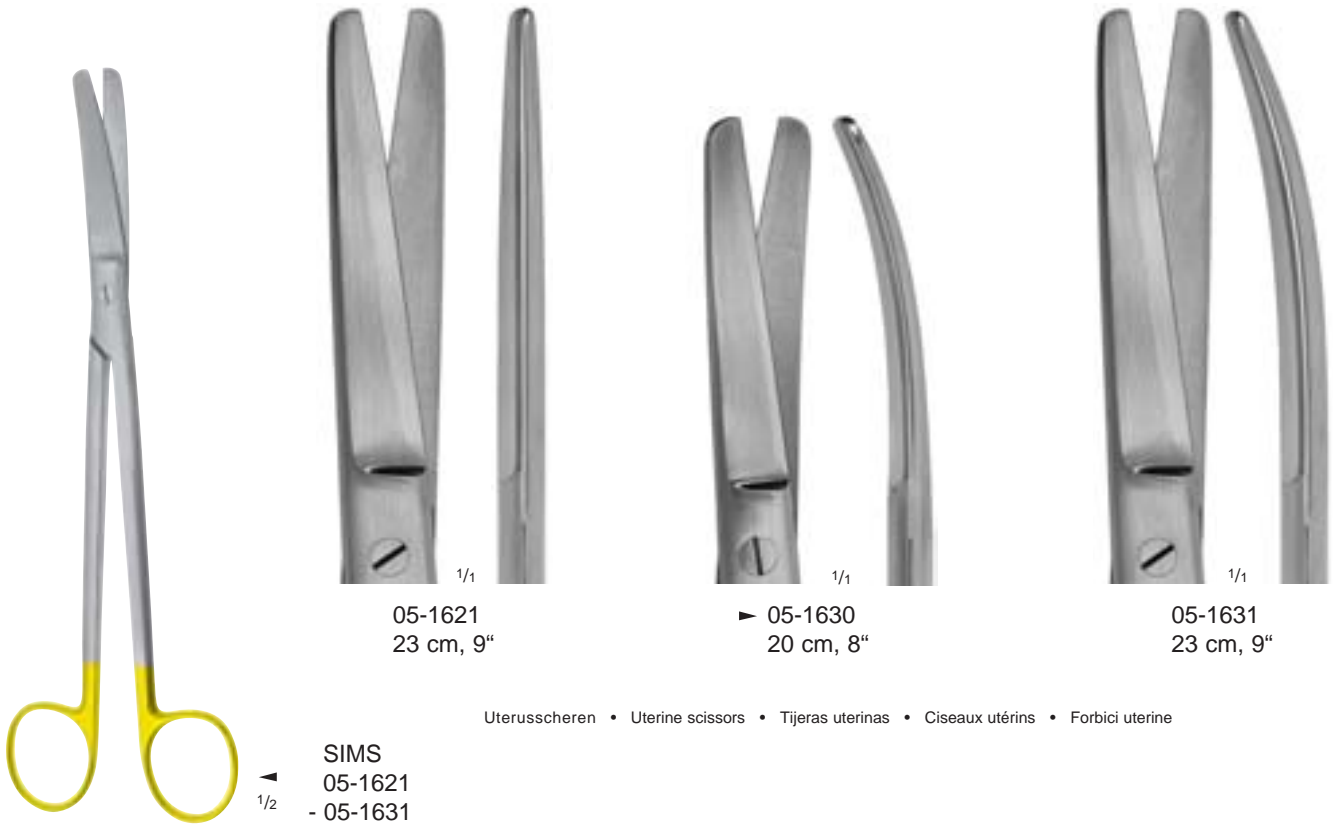

05-1621
23 cm, 9"

▶ 05-1630
20 cm, 8"

05-1631
23 cm, 9"

Uterusscheren • Uterine scissors • Tijeras uterinas • Ciseaux utérins • Forbici uterine

◀
1/2
SIMS
05-1621
- 05-1631



▶ 05-1650
22,5 cm, 9"

05-1652
22 cm, 8³/₄"

05-1650
- 05-1652

Parametriumscheren
 Parametrium scissors
 Tijeras parametrium
 Ciseaux à ligaments larges
 Parametrium forbici

◀
1/2

1 Blatt gezahnt
 1 blade serrated
 1 hoja dentada
 1 lame dentelée
 1 lama dentata

05-1680
19,5 cm, 7³/₄"

Damm- (Episiotomie-) Schere
 Perineum (episiotomy) scissors
 Tijera para perineo (para episiotomia)
 Ciseaux à épisiotomie
 Forbici per episiotomia

1/2



LAWNTON
Medizintechnik



Scheren
Scissors
Tijeras
Ciseaux
Forbici



Mikro-Scheren mit flachen Federgriffen
Micro Scissors with Flat Spring Type Handles
Micro-tijeras con mangos de resortes planos
Micro-ciseaux avec manches à ressorts plats
Micro-forbici con manici a molla piatta

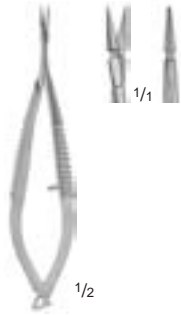

VANNAS
63-1400
8 cm, 3 1/8"

gerade
straight
recta
droit
retto

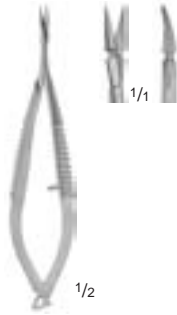

VANNAS
63-1401
8 cm, 3 1/8"

gebogen
curved
curva
courbe
curvo

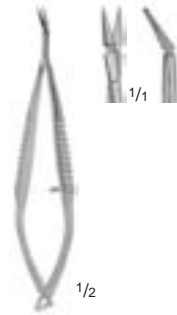

VANNAS
63-1402
8 cm, 3 1/8"

aufgewinkelt
angled on flat
angulada hacia arriba
coudé en haut
angolato in alto



VANNAS
63-1403
8 cm, 3 1/8"

seitlich abgewinkelt
angled on side
angulada hacia un lado
coudé sur le côté
angolato lateralmente

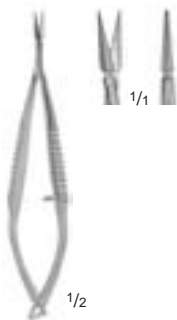

VANNAS
MOD. TÜBINGEN
63-1406
8,5 cm, 3 3/8"

gerade
straight
recta
droit
retto

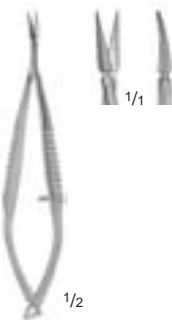

VANNAS
MOD. TÜBINGEN
63-1407
8,5 cm, 3 3/8"

gebogen
curved
curva
courbe
curvo

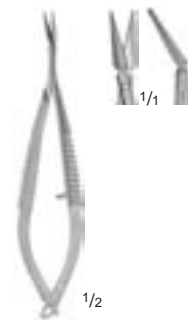

VANNAS
MOD. TÜBINGEN
63-1408
8,5 cm, 3 3/8"

aufgewinkelt
angled on flat
angulada hacia arriba
coudé en haut
angolato in alto

Mikro-Scheren mit flachen Federgriffen
 Micro Scissors with Flat Spring Type Handles
 Micro-tijeras con mangos de resortes planos
 Micro-ciseaux avec manches à ressorts plats
 Micro-forbici con manici a molla piatta



► 05-0020
 12 cm, 4³/₄"

gerade
 straight
 recta
 droit
 retto

1/2

VANNAS
 05-0020
 - 05-0023



1/1



1/1

05-0021
 12 cm, 4³/₄"

gebogen
 curved
 curva
 courbe
 curvo

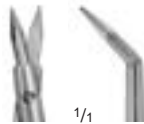

1/1

05-0023
 12 cm, 4³/₄"

aufgewinkelt
 angled on flat
 angulada hacia arriba
 coudé en haut
 angolato in alto



► 05-0026
 16 cm, 6¹/₄"

1/2

VANNAS
 05-0026
 - 05-0027



1/1



1/1

05-0027
 16 cm, 6¹/₄"



► 05-0030
 12,5 cm, 5"

1/2

05-0030
 - 05-0031



1/1



1/1

05-0031
 12,5 cm, 5"



1/1

1/2

BIEMER
 05-0028
 12,5 cm, 5"

Venenschere
 Vein scissors
 Tijera para venas
 Ciseaux pour veines
 Forbici per vene



Mikro-Scheren mit flachen Federgriffen
 Micro Scissors with Flat Spring Type Handles
 Micro-tijeras con mangos de resortes planos
 Micro-ciseaux avec manches à ressorts plats
 Micro-forbici con manici a molla piatta

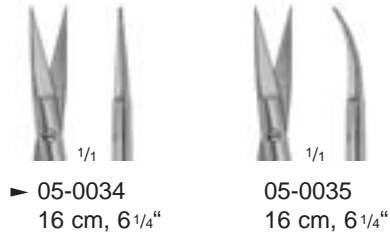

05-0034
- 05-0035

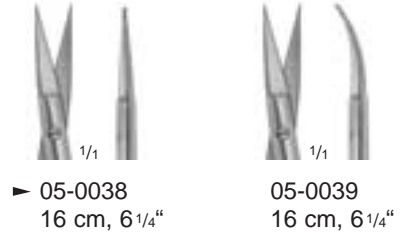

MILLESİ
05-0038
- 05-0039

Schneiden gezahnt
 toothed blades
 hojas dentadas
 Lames dentelées
 Lame dentate

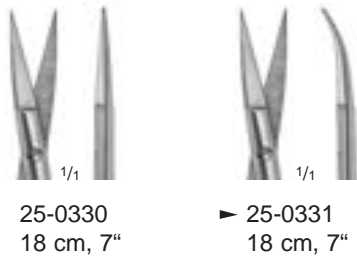

JACOBSON
25-0330
- 25-0331

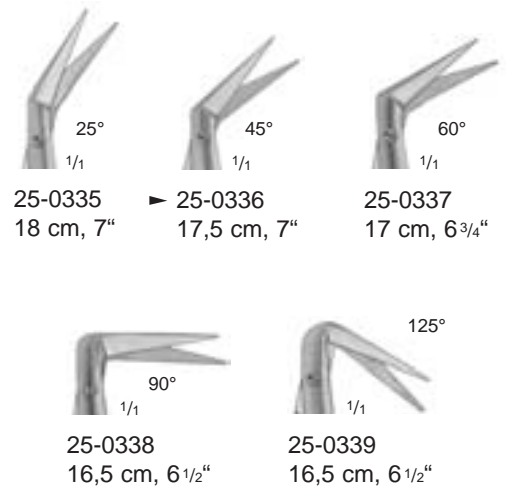

25-0335
- 25-0339

seitlich abgewinkelt
 angled on side
 angulada hacia un lado
 coudé sur le côté
 angolate lateralmente

Mikro-Scheren mit runden Federgriffen
 Micro Scissors with Round Spring Type Handles
 Micro-tijeras con mangos de resortes redondos
 Micro-ciseaux avec manches à ressorts ronds
 Micro-forbici con manici a molla rotonda

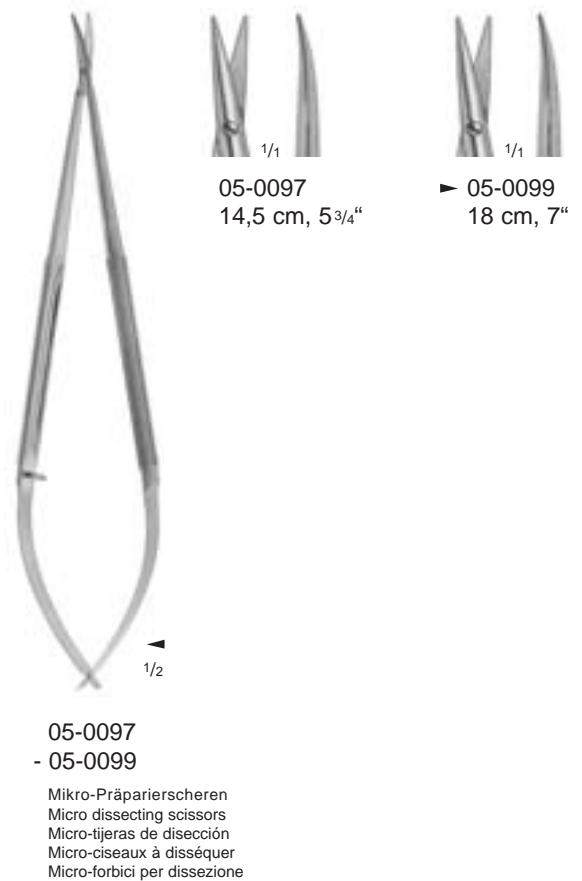
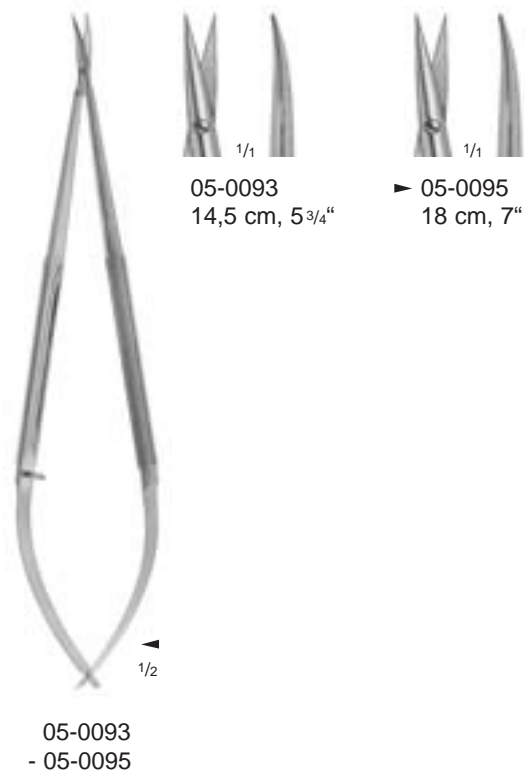
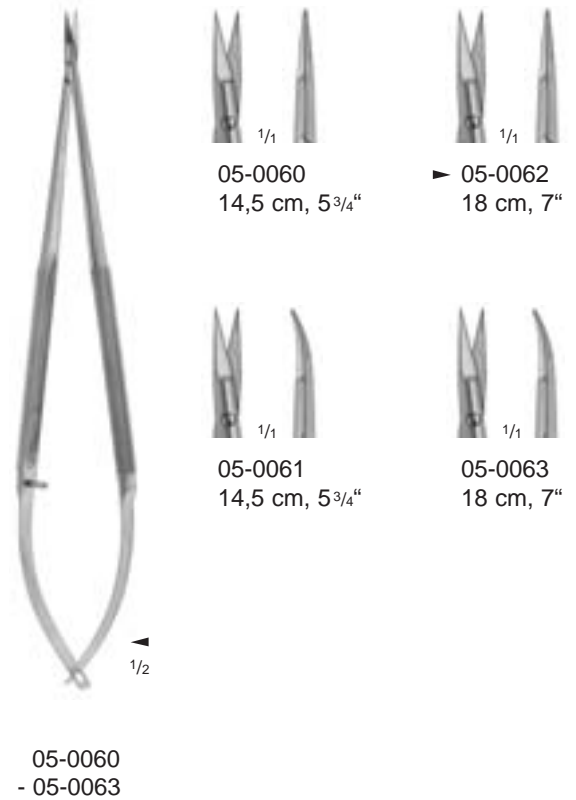
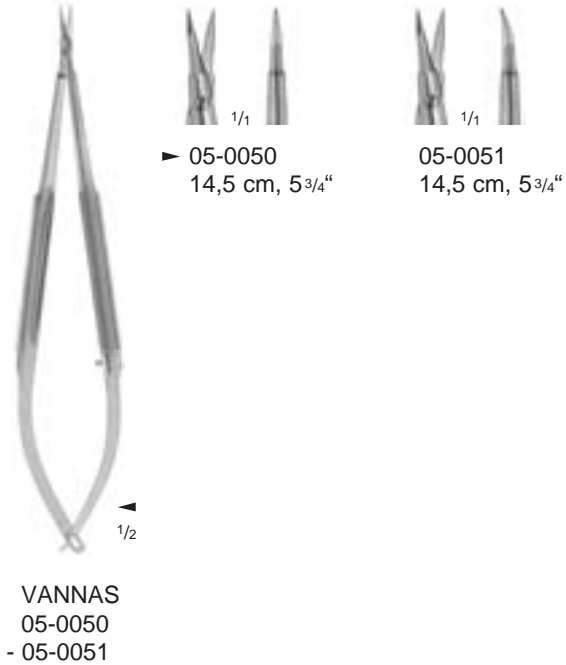



Mikro-Federscheren, bajonettförmig
 Micro Spring Type Scissors, bayonet-shaped
 Micro-tijeras con mangos de resortes, en forma bayoneta
 Micro-ciseaux en forme de baïonnette avec manches à ressorts
 Micro-forbici con manici a molla, forma a baionetta



▶ 57-1054
22,5 cm, 9"



57-1055
22,5 cm, 9"

VANNAS-YASARGIL
57-1054
- 57-1055

◀ 1/2



▶ 57-1064
16,5 cm, 6 1/2"



57-1065
16,5 cm, 6 1/2"

YASARGIL
57-1064
- 57-1065

◀ 1/2



▶ 57-1066
20 cm, 8"



57-1069
20 cm, 8"

YASARGIL
57-1066
- 57-1069

◀ 1/2



57-1067
20 cm, 8"



▶ 57-1072
22,5 cm, 9"



57-1073
22,5 cm, 9"

YASARGIL
57-1072
- 57-1073

◀ 1/2



YASARGIL
57-1074
22,5 cm, 9"

Schneiden gezahnt
toothed blades
hojas dentadas
Lames dentelées
Lame dentate

◀ 1/2



YASARGIL
57-1079
24,5 cm, 9 3/4"

◀ 1/2

Mikro-Federscheren, bajonettförmig
 Micro Spring Type Scissors, bayonet-shaped
 Micro-tijeras con mangos de resortes, en forma bayoneta
 Micro-ciseaux en forme de baïonnette avec manches à ressorts
 Micro-forbici con manici a molla, forma a baionetta

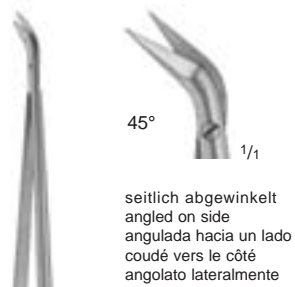

NAGEL
 57-1081
 19,5 cm, 7 3/4"

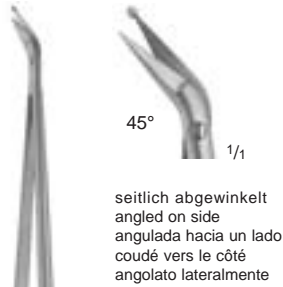

57-1082
 19,5 cm, 7 3/4"



57-1083
 18,5 cm, 7 1/4"

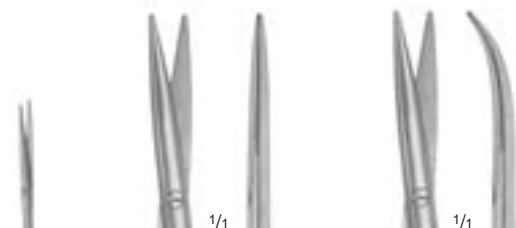

▶ **57-1086**
 20 cm, 8"

57-1087
 20 cm, 8"



YASARGIL
 57-1086
 - 57-1087

Mikro-Präparierscheren
 Micro dissecting scissors
 Micro-tijeras de disección
 Micro-ciseaux à disséquer
 Micro-forbici per dissezione

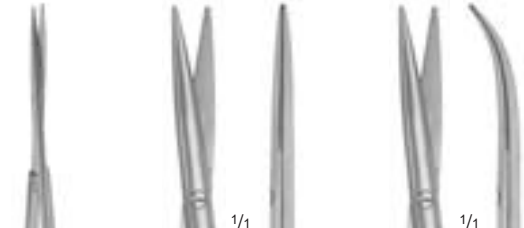

▶ **57-1088**
 22,5 cm, 9"

57-1089
 22,5 cm, 9"



YASARGIL
 57-1088
 - 57-1089

Mikro-Präparierscheren
 Micro dissecting scissors
 Micro-tijeras de disección
 Micro-ciseaux à disséquer
 Micro-forbici per dissezione



Feine chirurgische Scheren
 Delicate Surgical Scissors
 Tijeras finas para cirugía
 Ciseaux chirurgicaux fins
 Forbici fine per chirurgia



▶ 63-0906
9 cm, 3 1/2"



▶ 63-0910
10 cm, 4"



▶ 05-0330
10,5 cm, 4 1/8"



63-0906
- 63-0907



63-0907
9 cm, 3 1/2"



63-0910
- 63-0911



63-0911
10 cm, 4"



05-0330
- 05-0331



05-0331
10,5 cm, 4 1/8"



▶ 63-0330
10,5 cm, 4 1/8"



▶ 63-0331
10,5 cm, 4 1/8"



▶ 76-0415
11 cm, 4 3/8"



KNAPP
63-0330
- 63-0332



63-0332
10,5 cm, 4 1/8"



KNAPP
63-0331
- 63-0333



63-0333
10,5 cm, 4 1/8"



SEALY
76-0415
- 76-0416



76-0416
11 cm, 4 3/8"

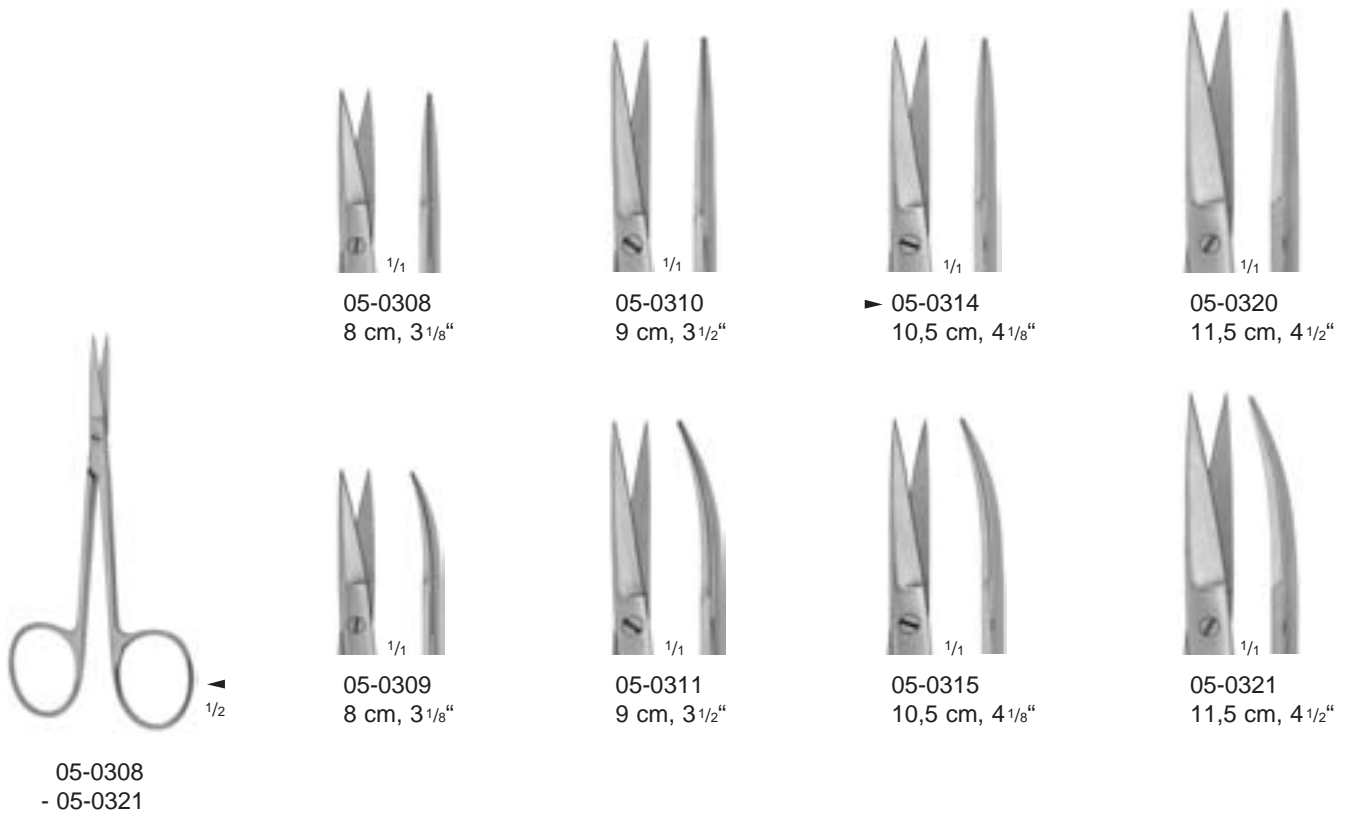



Feine chirurgische Scheren
 Delicate Surgical Scissors
 Tijeras finas para cirugía
 Ciseaux chirurgicaux fins
 Forbici fine per chirurgia

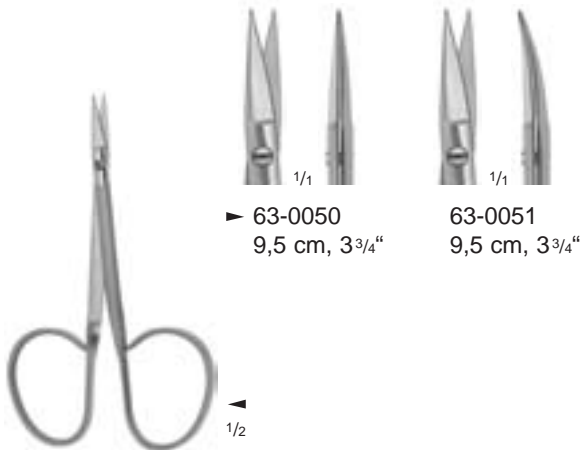

▶ 63-0050 9,5 cm, 3³/₄"
 ▶ 63-0051 9,5 cm, 3³/₄"

63-0050
 - 63-0051

mit flachen Branchen und großen ergonomischen Ringen
 with flat shanks and large ergonomical rings
 brazos de la tijera planos y con grandes anillos ergonómicos
 avec branches plates et grands anneaux ergonomiques
 con fusto piatto e grandi anelli ergonomici

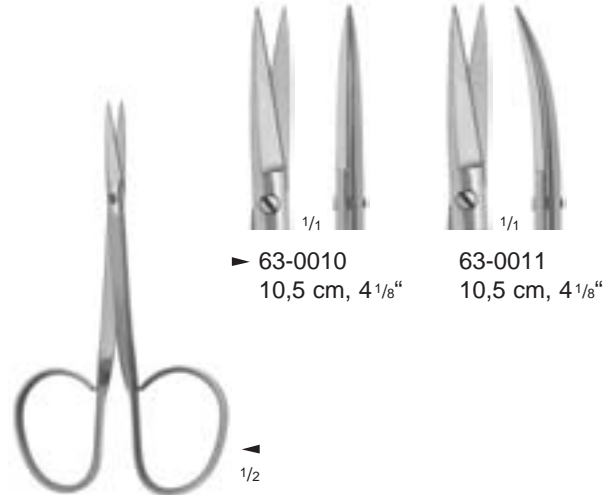

▶ 63-0010 10,5 cm, 4¹/₈"
 ▶ 63-0011 10,5 cm, 4¹/₈"

63-0010
 - 63-0011

mit flachen Branchen und großen ergonomischen Ringen
 with flat shanks and large ergonomical rings
 brazos de la tijera planos y con grandes anillos ergonómicos
 avec branches plates et grands anneaux ergonomiques
 con fusto piatto e grandi anelli ergonomici

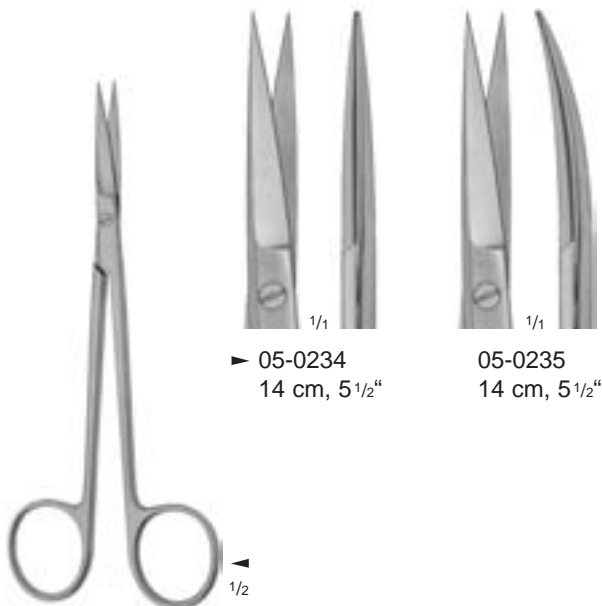

▶ 05-0234 14 cm, 5¹/₂"
 ▶ 05-0235 14 cm, 5¹/₂"

SANVENERO
 05-0234
 - 05-0235

Scheren für plastische Chirurgie
 Plastic surgery scissors
 Tijeras para la cirugía plástica
 Ciseaux pour chirurgie plastique
 Forbici per la chirurgia plastica

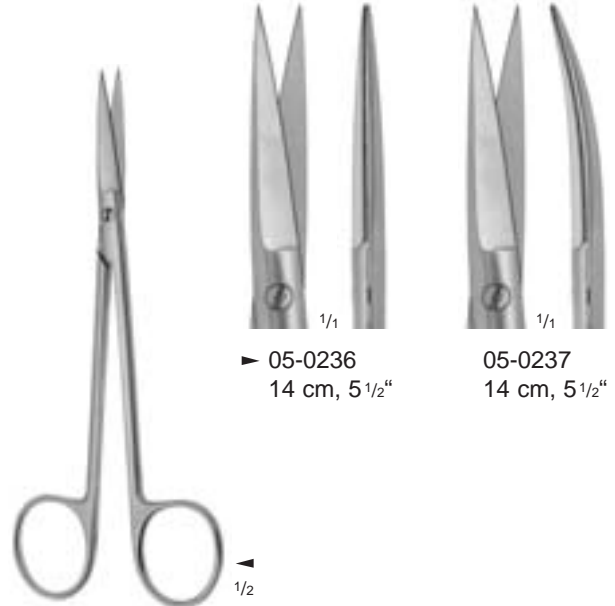

▶ 05-0236 14 cm, 5¹/₂"
 ▶ 05-0237 14 cm, 5¹/₂"

JOSEPH
 05-0236
 - 05-0237

Scheren für plastische Chirurgie
 Plastic surgery scissors
 Tijeras para la cirugía plástica
 Ciseaux pour chirurgie plastique
 Forbici per la chirurgia plastica



► 05-0220
 14 cm, 5 1/2"



► 05-0222
 14 cm, 5 1/2"



► 05-0224
 14 cm, 5 1/2"



05-0221
 14 cm, 5 1/2"



05-0223
 14 cm, 5 1/2"



05-0225
 14 cm, 5 1/2"



DEAVER
 05-0220
 - 05-0221



DEAVER
 05-0222
 - 05-0223



DEAVER
 05-0224
 - 05-0225



Chirurgische Scheren
Surgical Scissors
Tijeras para cirugía
Ciseaux à chirurgie
Forbici per chirurgia



05-0100
12 cm, 4^{3/4}"



05-0101
13 cm, 5^{1/8}"



▶ 05-0102
14,5 cm, 5^{3/4}"



05-0100
- 05-0104

Standard Modelle
Standard patterns
modelos standard
modèles standard
modelli standard



05-0103
15 cm, 6"



05-0104
16,5 cm, 6^{1/2}"



05-0105
 12 cm, 4^{3/4}"



05-0106
 13 cm, 5^{1/8}"



▶ 05-0107
 14,5 cm, 5^{3/4}"



05-0105
 - 05-0109

Standard Modelle
 Standard patterns
 modelos standard
 modèles standard
 modelli standard



05-0108
 15 cm, 6"



05-0109
 16,5 cm, 6^{1/2}"



Chirurgische Scheren
Surgical Scissors
Tijeras para cirugía
Ciseaux à chirurgie
Forbici per chirurgia



05-0110
12 cm, 4^{3/4}"



05-0111
13 cm, 5^{1/8}"



▶ 05-0112
14,5 cm, 5^{3/4}"



05-0113
15 cm, 6"



05-0114
16,5 cm, 6^{1/2}"



05-0135
17,5 cm, 7"



05-0136
18,5 cm, 7^{1/4}"



05-0138
20,5 cm, 8"



05-0110
- 05-0138

Standard Modelle
Standard patterns
modelos standard
modèles standard
modelli standard



05-0115
 12 cm, 4³/₄"



05-0116
 13 cm, 5¹/₈"



► 05-0117
 14,5 cm, 5³/₄"



05-0118
 15 cm, 6"



05-0119
 16,5 cm, 6¹/₂"



05-0145
 17,5 cm, 7"



05-0146
 18,5 cm, 7¹/₄"



05-0148
 20,5 cm, 8"



05-0115
 - 05-0148

Standard Modelle
 Standard patterns
 modelos standard
 modèles standard
 modelli standard



Chirurgische Scheren
Surgical Scissors
Tijeras para cirugía
Ciseaux à chirurgie
Forbici per chirurgia



05-0120
12 cm, 4³/₄"



05-0121
13 cm, 5¹/₈"



▶ 05-0122
14,5 cm, 5³/₄"



05-0123
15 cm, 6"



05-0124
16,5 cm, 6¹/₂"



05-0155
17,5 cm, 7"



05-0156
18,5 cm, 7¹/₄"



05-0158
20,5 cm, 8"



05-0120
- 05-0158

Standard Modelle
Standard patterns
modelos standard
modèles standard
modelli standard



05-0125
 12 cm, 4³/₄"



05-0126
 13 cm, 5¹/₈"



▶ 05-0127
 14,5 cm, 5³/₄"



05-0128
 15 cm, 6"



05-0129
 16,5 cm, 6¹/₂"



05-0185
 17,5 cm, 7"



05-0186
 18,5 cm, 7¹/₄"



05-0188
 20,5 cm, 8"



05-0125
 - 05-0188

Standard Modelle
 Standard patterns
 modelos standard
 modèles standard
 modelli standard



Chirurgische Scheren
Surgical Scissors
Tijeras para cirugía
Ciseaux à chirurgie
Forbici per chirurgia



05-0200 12,5 cm, 5"
05-0210 13 cm, 5 1/8"
▶ 05-0250 14,5 cm, 5 3/4"

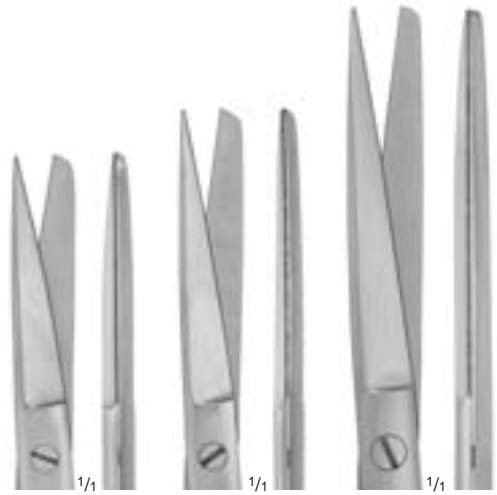

05-0202 12,5 cm, 5"
05-0212 13 cm, 5 1/8"
▶ 05-0252 14,5 cm, 5 3/4"

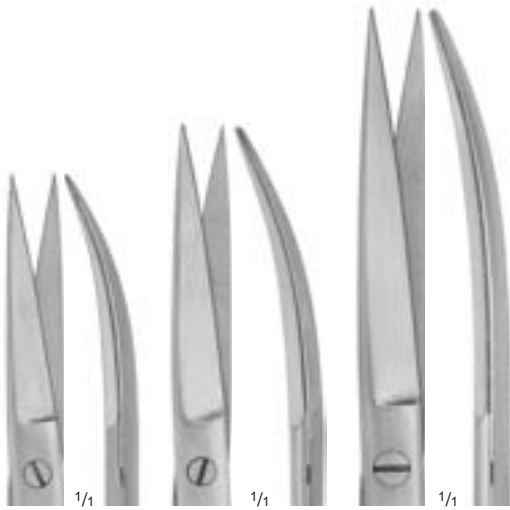

05-0201 12,5 cm, 5"
05-0211 13 cm, 5 1/8"
05-0251 14,5 cm, 5 3/4"

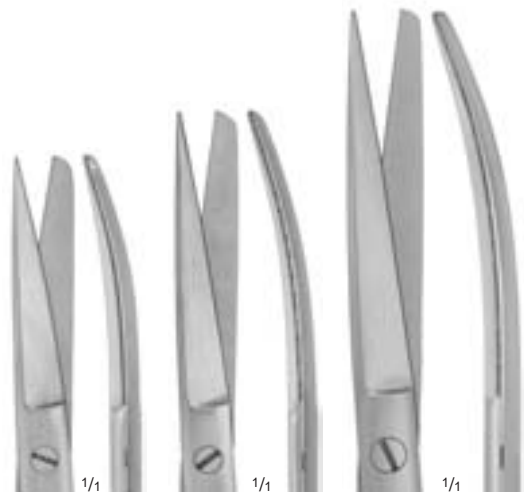

05-0203 12,5 cm, 5"
05-0213 13 cm, 5 1/8"
05-0253 14,5 cm, 5 3/4"



05-0200
- 05-0251

schlanke Modelle
slender patterns
modelos finos
modèles fins
modelli fini



05-0202
- 05-0253

schlanke Modelle
slender patterns
modelos finos
modèles fins
modelli fini



05-0204
 12,5 cm, 5"



05-0214
 13 cm, 5 1/8"



▶ 05-0254
 14,5 cm, 5 3/4"



▶ 05-0230
 15,5 cm, 6"



05-0205
 12,5 cm, 5"



05-0215
 13 cm, 5 1/8"



05-0255
 14,5 cm, 5 3/4"



05-0231
 15,5 cm, 6"



05-0204
 - 05-0255

schlanke Modelle
 slender patterns
 modelos finos
 modèles fins
 modelli fini



MIXTER
 05-0230
 - 05-0231



Chirurgische Scheren
Surgical Scissors
Tijeras para cirugía
Ciseaux à chirurgie
Forbici per chirurgia



► 05-0240
16 cm, 6 1/4"



05-0241
16 cm, 6 1/4"

KELLY
05-0240
- 05-0241

Gefäß- und Fistelscheren
Vascular and fistula scissors
Tijeras para vasos y fistulas
Ciseaux vasculaires et pour des fistules
Forbici vascolare e per fistole



RICHTER
05-0177
14 cm, 5 1/2"

Operationsschere
Operating scissors
Tijera para operaciones
Ciseaux pour opérations
Forbici per operazioni



► 05-0166
13 cm, 5 1/8"



05-0167
14,5 cm, 5 3/4"

05-0166
- 05-0167

Inzisionsscheren
Incision scissors
Tijeras para incisión
Ciseaux à incision
Forbici incisione



FERGUSON
05-0785
18 cm, 7"

Operationsschere
Operating scissors
Tijera para operaciones
Ciseaux pour opérations
Forbici per operazioni

Chirurgische Scheren
Surgical Scissors
Tijeras para cirugía
Ciseaux à chirurgie
Forbici per chirurgia

Präparierscheren
Dissecting Scissors
Tijeras de disección
Ciseaux à dissection
Forbici per dissezione



SYSTRUNK
05-0197
13 cm, 5 1/8"

Nagelspaltschere
Nail splitting scissors
Tijera para hender las uñas
Ciseaux à fendre les ongles
Forbici per fissurare le unghie



05-0198
15,5 cm, 6"

Nagelspaltschere
Nail splitting scissors
Tijera para hender las uñas
Ciseaux à fendre les ongles
Forbici per fissurare le unghie

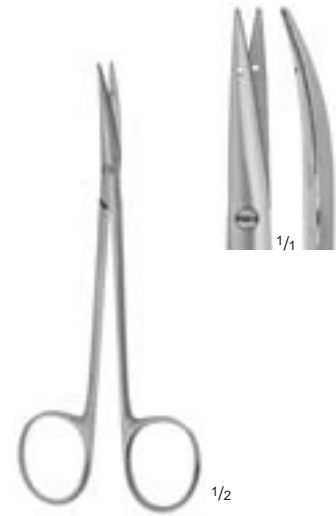

LITTLER
76-0760
12 cm, 4 3/4"

Präparierschere mit Fadenbohrung
in der Spitze
Dissecting scissors, tips with eye for
suture
Tijera de disección, con ojal en las
puntas
Ciseaux à dissection avec chas
Forbici per dissezione con foro per
il filo alla punta



05-0549
12 cm, 4 3/4"

Präparierschere
Dissecting scissors
Tijera de disección
Ciseaux à dissection
Forbici per dissezione



FOMON
76-0620
11,5 cm, 4 1/2"

Nasenflügelschere
Lower lateral scissors
Tijera para ala nasal
Ciseaux pour ailes du nez
Forbici con aletta nasale



FOMON
76-0623
14 cm, 5 1/2"

Nasenflügelschere
Lower lateral scissors
Tijera para ala nasal
Ciseaux pour ailes du nez
Forbici con aletta nasale



Chirurgische Scheren und Präparierscheren, Blätter außen angeschliffen

Surgical and Dissecting Scissors, outside cutting edges

Tijeras para cirugía y disección, con filos de corte exteriores

Ciseaux à chirurgie et à dissection, lames aiguisées à l'extérieur

Forbici per chirurgia e per dissezione, con lame affilate all'esterno



▶ 76-0610
13,5 cm, 5 1/4"



76-0611
13,5 cm, 5 1/4"

1 Blatt gezahnt
1 blade serrated
1 hoja dentada
1 lame dentelée
1 lama dentata

FOMON
76-0610
- 76-0611

Scheren für plastische Chirurgie
Plastic surgery scissors
Tijeras para la cirugía plástica
Ciseaux pour chirurgie plastique
Forbici per la chirurgia plastica



▶ 76-0472
15 cm, 6"



76-0473
15 cm, 6"

AUFRICT
76-0472
- 76-0473

Scheren für plastische Chirurgie
Plastic surgery scissors
Tijeras para la cirugía plástica
Ciseaux pour chirurgie plastique
Forbici per la chirurgia plastica



▶ 76-0478
19,5 cm, 7 3/4"



76-0479
19,5 cm, 7 3/4"

Blätter innen fein gezahnt
blades inside with fine serration
hojas dentadas finas en el interior
lames dentelées délicatement à l'intérieur
lama interne finemente dentate

GORNEY
76-0478
- 76-0479

Scheren für plastische Chirurgie
Plastic surgery scissors
Tijeras para la cirugía plástica
Ciseaux pour chirurgie plastique
Forbici per la chirurgia plastica



MC INDOE
76-0475
18,5 cm, 7 1/4"



Knorpelschere
Scissors for cartilage
Tijera para cartilago
Ciseaux pour cartilage
Forbici per cartilagini

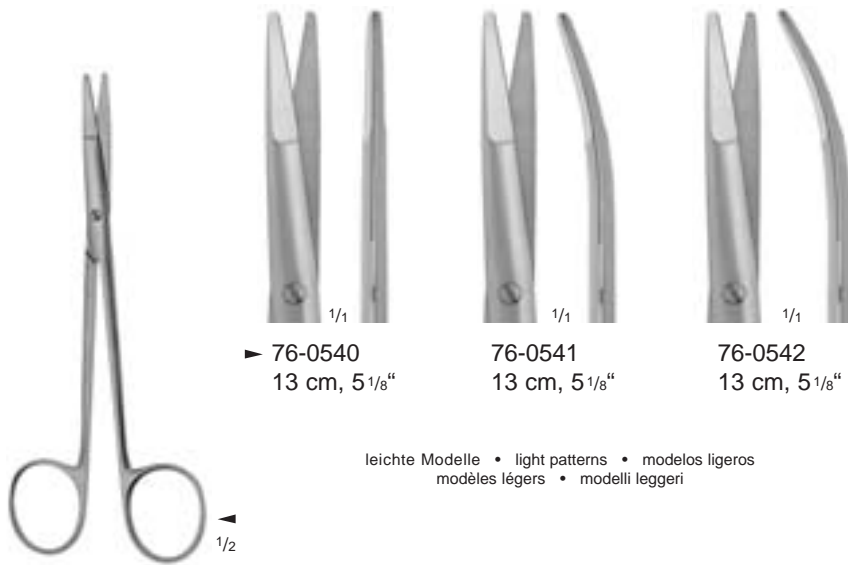

▶ 76-0540 13 cm, 5 1/8"
 ▶ 76-0541 13 cm, 5 1/8"
 ▶ 76-0542 13 cm, 5 1/8"

leichte Modelle • light patterns • modelos ligeros
 modèles légers • modelli leggeri

RAGNELL
 76-0540
 - 76-0542

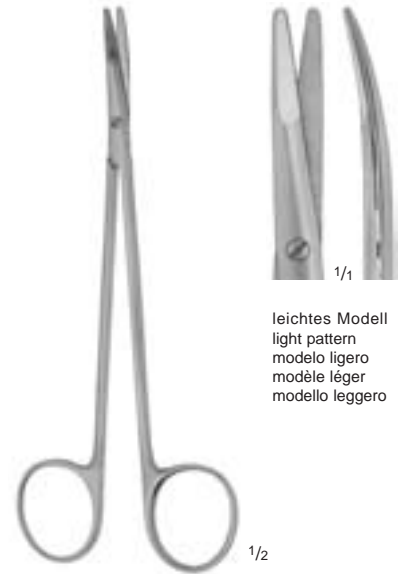

leichtes Modell
 light pattern
 modelo ligero
 modèle léger
 modello leggero

RAGNELL
 76-0543
 15 cm, 6"



05-0541 12,5 cm, 5"
 05-0585 13,5 cm, 5 1/4"

▶ 05-0543 15 cm, 6"
 05-0587 17,5 cm, 7"

kräftige Modelle • heavy patterns • modelos fuertes
 modèles fort • modelli robusti

KILNER (GLASSMANN)
 05-0541
 - 05-0587

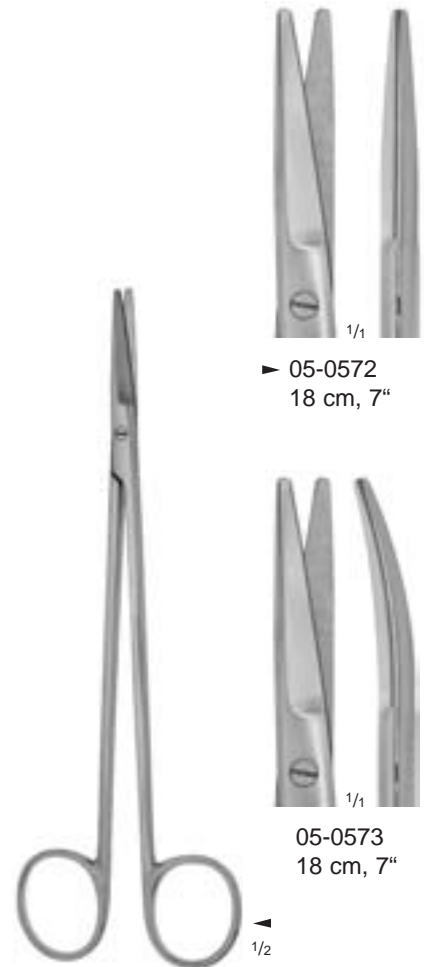

▶ 05-0572 18 cm, 7"

05-0573 18 cm, 7"

TOENNIS
 05-0572
 - 05-0573



Präparierscheren
Dissecting Scissors
Tijeras de disección
Ciseaux à dissection
Forbici per dissezione



05-0450
14,5 cm, 5³/₄"



▶ 05-0452
15 cm, 6"



05-0460
17 cm, 6³/₄"



05-0464
23 cm, 9"



05-0451
14,5 cm, 5³/₄"



05-0453
15 cm, 6"



05-0461
17 cm, 6³/₄"



05-0465
23 cm, 9"



MAYO
05-0450
- 05-0465



05-0482
 15 cm, 6"



▶ 05-0490
 17 cm, 6³/₄"



05-0492
 19,5 cm, 7³/₄"



MAYO-STILLE
 05-0482
 - 05-0495



05-0483
 15 cm, 6"



05-0491
 17 cm, 6³/₄"



05-0493
 19,5 cm, 7³/₄"



05-0495
 21 cm, 8¹/₄"



Präparierscheren
Dissecting Scissors
Tijeras de disección
Ciseaux à dissection
Forbici per dissezione



► 05-0400
16,5 cm, 6 1/2"



► 05-0470
23 cm, 9"



05-0401
16,5 cm, 6 1/2"



05-0471
23 cm, 9"



MAYO-NOBLE
05-0400
- 05-0401



MAYO-HARRINGTON
05-0470
- 05-0471



► 05-0550
 10,5 cm, 4 1/8"



► 05-0420
 16 cm, 6 1/4"



► 05-0416
 16,5 cm, 6 1/2"



05-0551
 10,5 cm, 4 1/8"



05-0421
 16 cm, 6 1/4"



05-0417
 16,5 cm, 6 1/2"



BABY-LEXER
 05-0550
 - 05-0551



MAYO-LEXER
 05-0420
 - 05-0421



LEXER
 05-0416
 - 05-0417



Präparierscheren
Dissecting Scissors
Tijeras de disección
Ciseaux à dissection
Forbici per dissezione



63-0200
- 63-0202



▶ 63-0200
10,5 cm, 4 1/8"



▶ 63-0201
10,5 cm, 4 1/8"



▶ 63-0202
10,5 cm, 4 1/8"

mit flachen Branchen und großen ergonomischen Ringen
with flat shanks and large ergonomical rings
brazos de la tijera planos y con grandes anillos ergonómicos
avec branches plates et grands anneaux ergonomiques
con fusto piatto e grandi anelli ergonomici



▶ 63-0402
11,5 cm, 4 1/2"



▶ 63-0403
11,5 cm, 4 1/2"



METZENBAUM
63-0402
- 63-0403



▶ 05-0554
12,5 cm, 5"



▶ 05-0555
12,5 cm, 5"



METZENBAUM
05-0554
- 05-0555

Präparierscheren

Dissecting Scissors

Tijeras de disección

Ciseaux à dissection

Forbici per dissezione

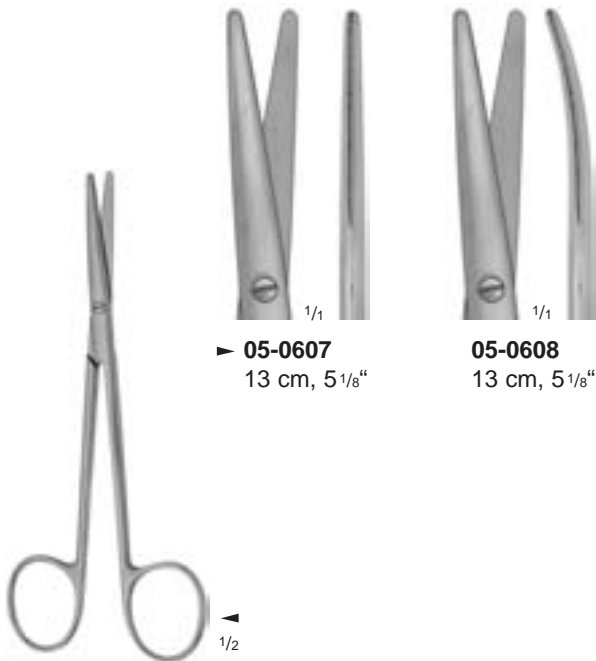

► **05-0607**
13 cm, 5 1/8"

05-0608
13 cm, 5 1/8"

METZENBAUM
05-0607
- **05-0608**



► **05-0560**
14,5 cm, 5 3/4"

05-0561
14,5 cm, 5 3/4"

BABY-METZENBAUM
05-0560
- **05-0561**

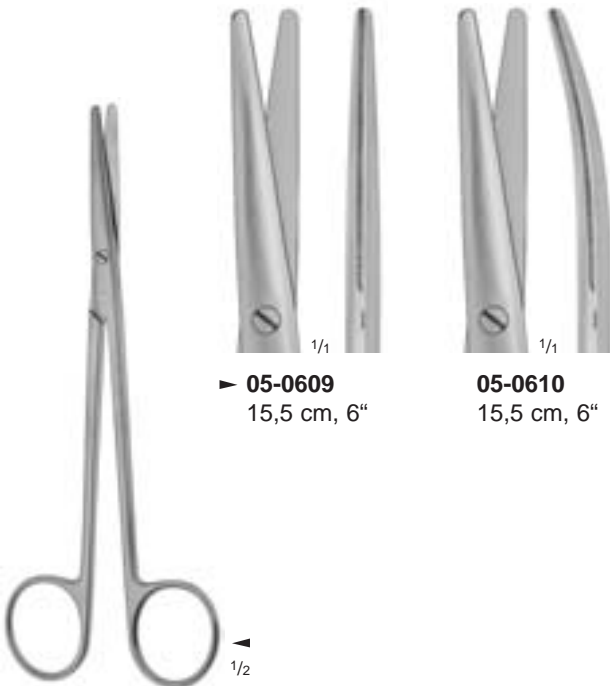

► **05-0609**
15,5 cm, 6"

05-0610
15,5 cm, 6"

METZENBAUM
05-0609
- **05-0610**



sehr feines Model
very delicate pattern
modelo muy fino
modèle très fin
modello molto delicato

TOENNIS-ADSON
05-0575
17,5 cm, 7"



Präparierscheren
 Dissecting Scissors
 Tijeras de disección
 Ciseaux à dissection
 Forbici per dissezione

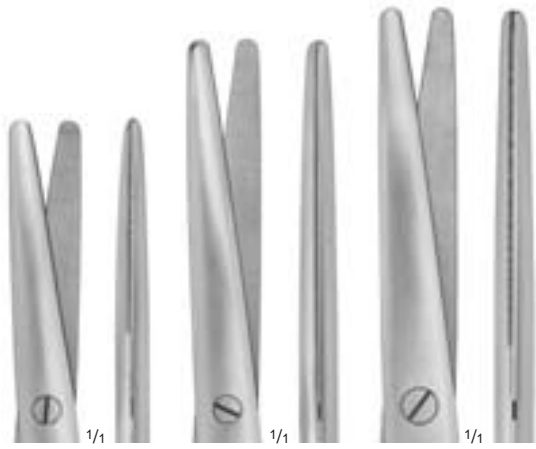

► **05-0619**
18 cm, 7"

05-0621
20,5 cm, 8"

05-0640
23 cm, 9"

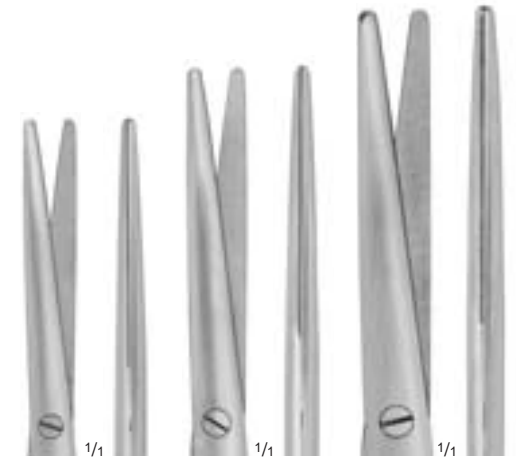

► **05-0660**
18 cm, 7"

05-0662
20,5 cm, 8"

05-0664
23 cm, 9"



05-0620
18 cm, 7"

05-0622
20,5 cm, 8"

05-0641
23 cm, 9"

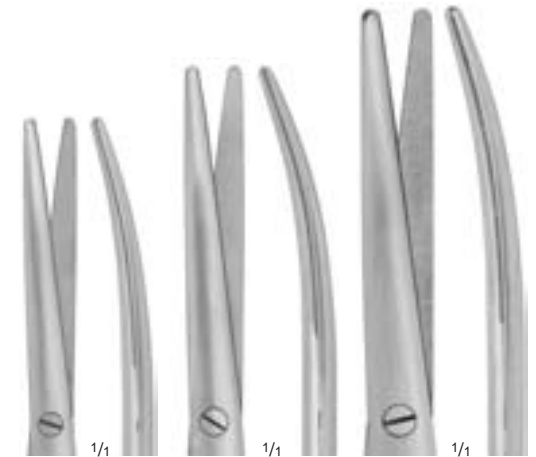

05-0661
18 cm, 7"

05-0663
20,5 cm, 8"

05-0665
23 cm, 9"

Standard Modelle
 Standard patterns
 modelos standard
 modèles standard
 modelli standard

feine Modelle
 delicate patterns
 modelos finos
 modèles fins
 modelli delicati



METZENBAUM
05-0619
 - 05-0641



METZENBAUM
05-0660
 - 05-0665

Präparierscheren

Dissecting Scissors

Tijeras de disección

Ciseaux à dissection

Forbici per dissezione



05-0642
26 cm, 10 1/4"



▶ **05-0644**
28,5 cm, 11 1/4"



05-0643
26 cm, 10 1/4"



05-0645
28,5 cm, 11 1/4"



NELSON-METZENBAUM
05-0642
- **05-0645**



Feine Präparier- und Sehnenscheren

Delicate Dissecting and Tendon Scissors

Tijeras finas de disección y tenotomía

Ciseaux fins à dissection et à ténotomie

Forbici fine per dissezione e per tenotomia

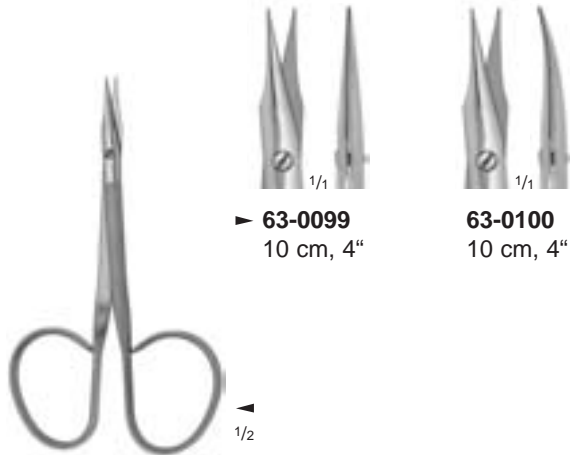

► **63-0099**
10 cm, 4"

► **63-0100**
10 cm, 4"

◄ 1/2

STEVENS

63-0099

- **63-0100**

mit flachen Branchen und großen ergonomischen Ringen
with flat shanks and large ergonomical rings
brazos de la tijera planos y con grandes anillos ergonómicos
avec branches plates et grands anneaux ergonomiques
con fusto piatto e grandi anelli ergonomici

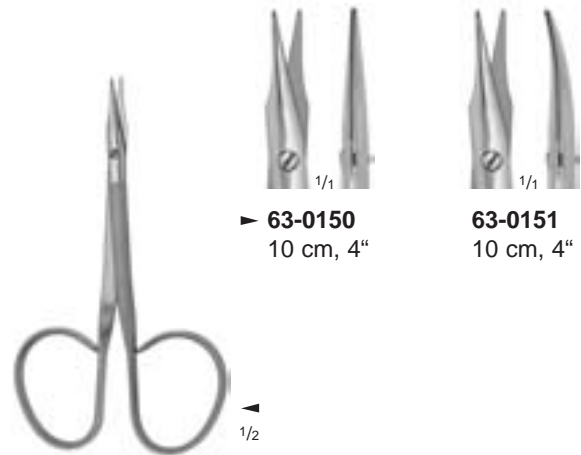

► **63-0150**
10 cm, 4"

► **63-0151**
10 cm, 4"

◄ 1/2

STEVENS

63-0150

- **63-0151**

mit flachen Branchen und großen ergonomischen Ringen
with flat shanks and large ergonomical rings
brazos de la tijera planos y con grandes anillos ergonómicos
avec branches plates et grands anneaux ergonomiques
con fusto piatto e grandi anelli ergonomici

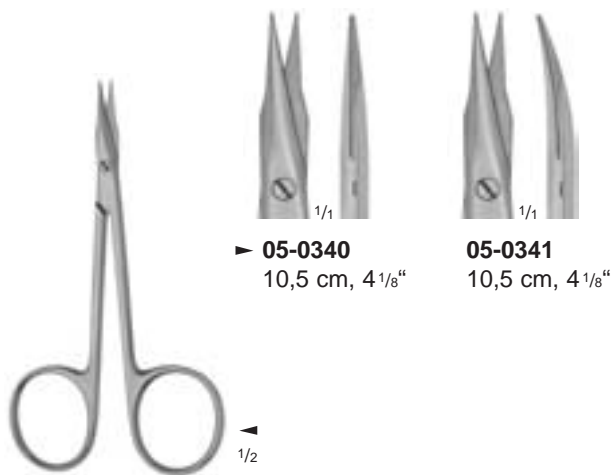

► **05-0340**
10,5 cm, 4 1/8"

► **05-0341**
10,5 cm, 4 1/8"

◄ 1/2

STEVENS

05-0340

- **05-0341**

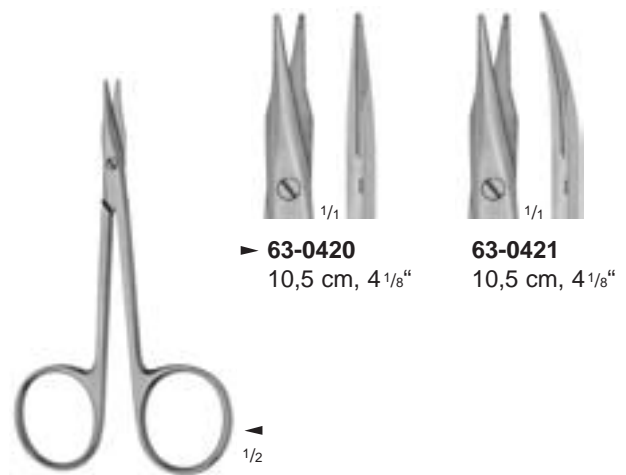

► **63-0420**
10,5 cm, 4 1/8"

► **63-0421**
10,5 cm, 4 1/8"

◄ 1/2

STEVENS

63-0420

- **63-0421**

Feine Präparierscheren
 Delicate Dissecting Scissors
 Tijeras de disección
 Ciseaux fins à dissection
 Forbici fine per dissezione

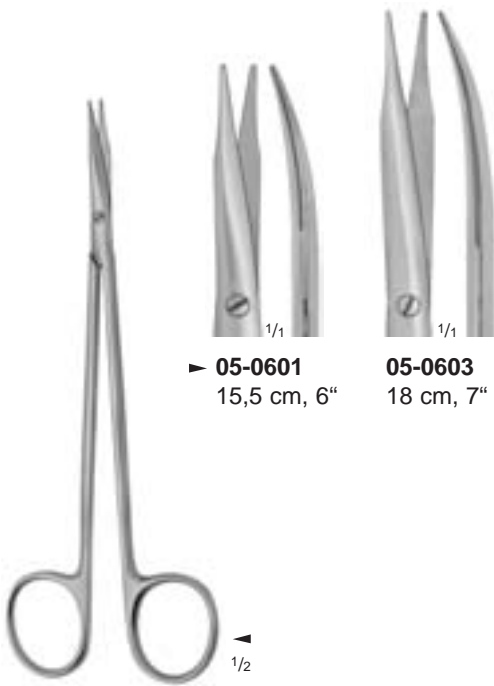

► **05-0601** 15,5 cm, 6"
05-0603 18 cm, 7"

JAMESON
05-0601
 - **05-0603**

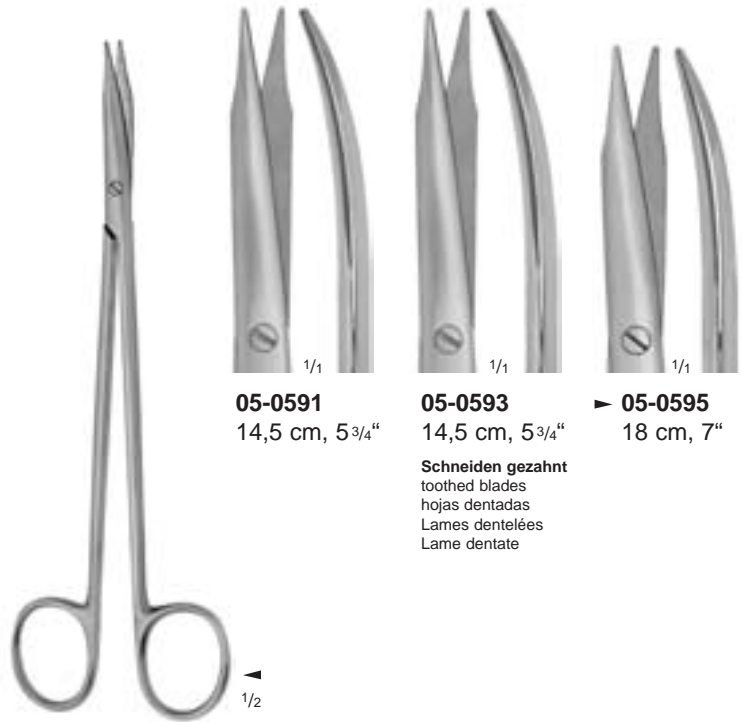

05-0591 14,5 cm, 5 3/4"
05-0593 14,5 cm, 5 3/4"
 ► **05-0595** 18 cm, 7"

Schneiden gezahnt
 toothed blades
 hojas dentadas
 Lames dentelées
 Lame dentate

REYNOLDS
05-0591
 - **05-0595**

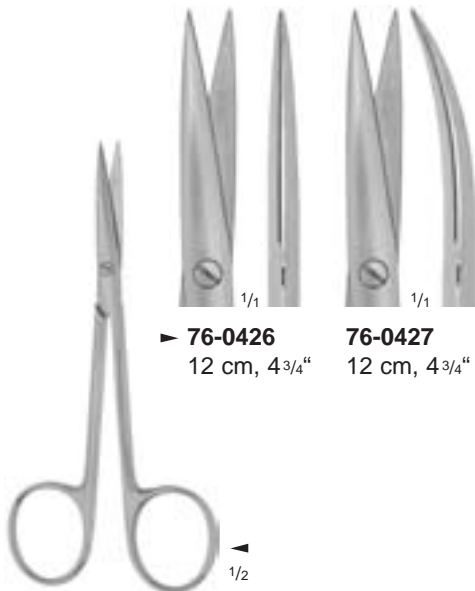

► **76-0426** 12 cm, 4 3/4"
76-0427 12 cm, 4 3/4"

KILNER
76-0426
 - **76-0427**



► **76-0570** 14,5 cm, 5 3/4"
76-0571 14,5 cm, 5 3/4"

BROPHY (SULLIVAN)
76-0570
 - **76-0571**

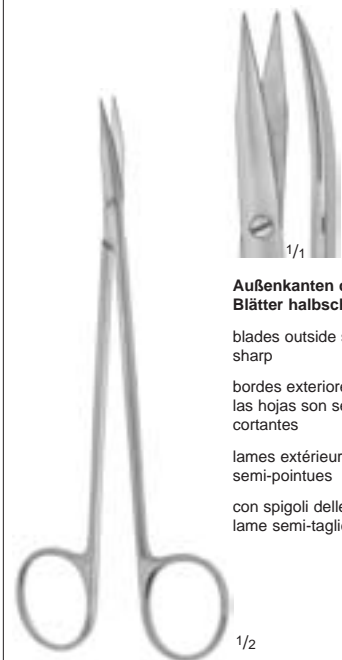

Außenkanten der Blätter halbscharf
 blades outside semi-sharp
 bordes exteriores de las hojas son semi-cortantes
 lames extérieures semi-pointues
 con spigoli delle lame semi-taglienti

05-0567
 15 cm, 6"

Nerv-Präparierschere
 Nerve dissecting scissors
 Tijera para nervios
 Ciseaux à dissection des nerfs
 Forbici per dissezione di nervi



Zahnfleischscheren

Gum Scissors

Tijeras para encías

Ciseaux pour gencive

Forbici per gengiva



LA GRANGE
63-1360
11,5 cm, 4 1/2"



GOLDMANN-FOX
05-0440
- **05-0441**



► **05-0440**
13 cm, 5 1/8"



05-0441
13 cm, 5 1/8"

1 Blatt gezahnt
1 blade serrated
1 hoja dentada
1 lame dentelée
1 lama dentata



QUINBY
76-0561
13 cm, 5 1/8"

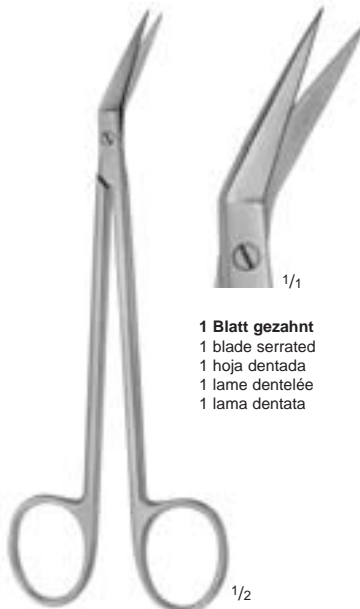

LOCKLIN
05-0443
16 cm, 6 1/4"

1 Blatt gezahnt
1 blade serrated
1 hoja dentada
1 lame dentelée
1 lama dentata

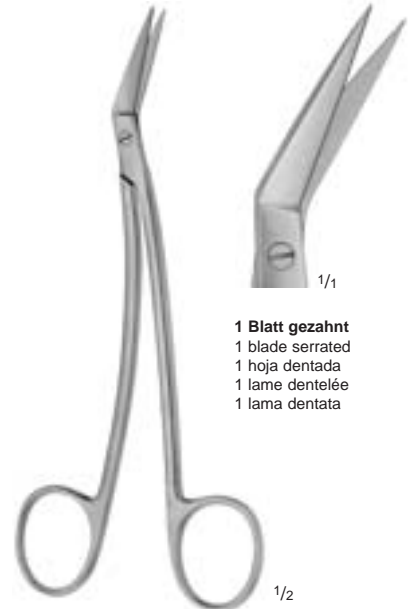

LOCKLIN
05-0445
16 cm, 6 1/4"

1 Blatt gezahnt
1 blade serrated
1 hoja dentada
1 lame dentelée
1 lama dentata

Gefäßscheren

Vascular Scissors

Tijeras vasculares

Ciseaux vasculaires

Forbici vascolari

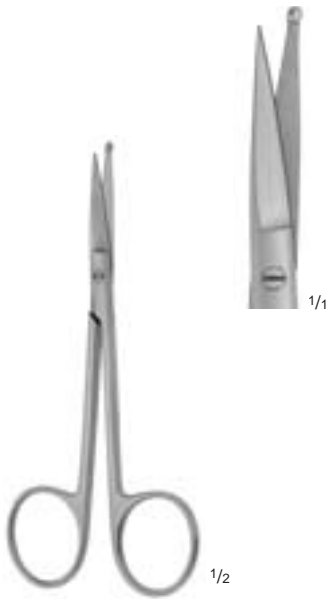

05-0364
12 cm, 4^{3/4}"

Präparierschere mit 1 geknöpften Blatt
Dissecting scissors with 1 probe-pointed blade
Tijera de disección con una punta botonada
Ciseaux à dissection avec 1 lame boutonnée
Forbici per dissezione con 1 lama botonuta



05-0366
14,5 cm, 5^{3/4}"

Präparierschere mit Sondenspitze
Dissecting scissors with 1 probe-pointed blade
Tijera de disección con una punta de sonda
Ciseaux à dissection avec 1 pointe pour sonde
Forbici per dissezione con 1 punta per sonda



FAVALORO
30-0187
14 cm, 5^{1/2}"

Coronararterien-Schere
Coronary artery scissors
Tijera para arteria coronar
Ciseaux coronaire
Forbici per arteria coronaria

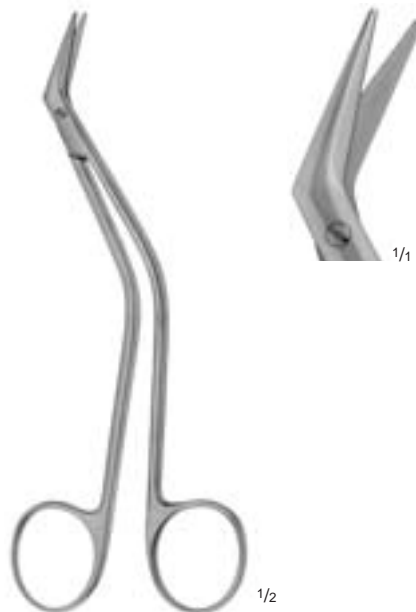

DE BAKEY
30-0185
16 cm, 6^{1/4}"

Arteriotomieschere
Arteriotomy scissors
Tijera para arteriotomia
Ciseaux à artériotomie
Forbici per arteriotomia



Gefäßscheren

Vascular Scissors

Tijeras vasculares

Ciseaux vasculaires

Forbici vascolari



30-0211
18 cm, 7"



30-0212
18 cm, 7"



▶ **30-0213**
17,5 cm, 7"



30-0214
17 cm, 6 3/4"



30-0216
17 cm, 6 3/4"



HEGEMANN-DIETRICH
30-0211
- **30-0216**

seitlich abgewinkelt
angled on side
angulada hacia un lado
coudé vers le côté
angolato lateralmente



▶ **30-0200**
19 cm, 7 1/2"



30-0205
18,5 cm, 7 1/4"

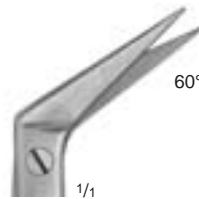

30-0210
18 cm, 7"



30-0208
18 cm, 7"

1 Blatt geknöpft
1 probe-pointed blade
1 hoja botonada
1 lame boutonnée
1 lama bottonuta



POTTS-SMITH
30-0200
- **30-0210**

seitlich abgewinkelt
angled on side
angulada hacia un lado
coudé vers le côté
angolato lateralmente



30-0221
17 cm, 6 3/4"

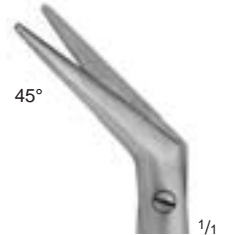

▶ **30-0224**
16,5 cm, 6 1/2"



30-0227
16 cm, 6 1/4"



DE BAKEY
30-0221
- **30-0227**

seitlich abgewinkelt
angled on side
angulada hacia un lado
coudé vers le côté
angolato lateralmente

Gefäßscheren

Vascular Scissors

Tijeras vasculares

Ciseaux vasculaires

Forbici vascolari

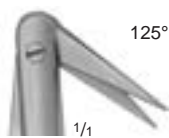

125°

1/4



1/4

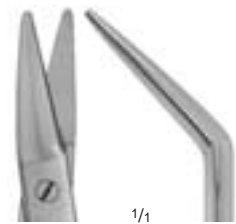

1/2



1/2

DIETRICH
30-0236
17,5 cm, 7"

seitlich abgewinkelt
angled on side
angulada hacia un lado
coudé vers le côté
angolato lateralmente



1/2

POTTS-SMITH
30-0189
19 cm, 7 1/2"

aufgewinkelt
angled on flat
angulada hacia arriba
coudé en haut
curvo in alto



1/2

POTTS-SMITH
30-0190
19 cm, 7 1/2"

aufgewinkelt
angled on flat
angulada hacia arriba
coudé en haut
curvo in alto



Gefäßscheren

Vascular Scissors

Tijeras vasculares

Ciseaux vasculaires

Forbici vascolari

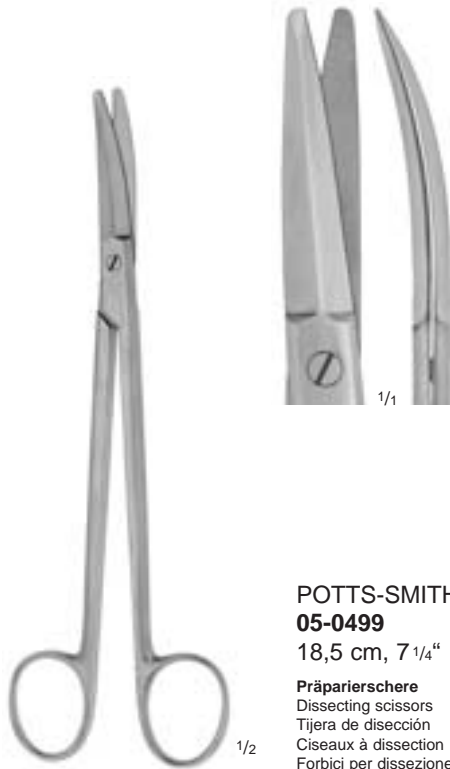

POTTS-SMITH

05-0499

18,5 cm, 7 1/4"

Präparierschere
Dissecting scissors
Tijera de disección
Ciseaux à dissection
Forbici per dissezione



► **05-0655**

18,5 cm, 7 1/4"

05-0657

25,5 cm, 10"

THOREK

05-0655

- **05-0657**

Präparierschere
Dissecting scissors
Tijeras de disección
Ciseaux à dissection
Forbici per dissezione



JORGENSON

30-0247

22 cm, 8 3/4"

Präparierschere
Dissecting scissors
Tijera de disección
Ciseaux à dissection
Forbici per dissezione



KLINGENBERGH-LOTH

05-0435

23 cm, 9"

Präparierschere
Dissecting scissors
Tijera de disección
Ciseaux à dissection
Forbici per dissezione

Vena cave-Schere

Vena Cava Scissors
Tijera para la vena cava
Ciseaux pour la veine cave
Forbici per vena cava

Lungenlappen- und Rektumschere

Lobectomy and Rectal Scissors
Tijera para lobectomía y recto
Ciseaux à lobectomie et pour le rectum
Forbici per lobo polmonare e per il retto



SATINSKY

30-0260

24,5 cm, 9^{3/4}"

Schere zum Ausschneiden eines Teiles der vena cava inferior vor Anastomose

Scissors for cutting out a part of the vena cava inferior before Anastomosis

Tijera para cortar una parte de la vena cava inferior, antes de anastomosis

Ciseaux pour enlever une partie la veine cave inférieure avant l'anastomose

Forbici per estinguere una parte della vena cava inferiore prima di anastomosi

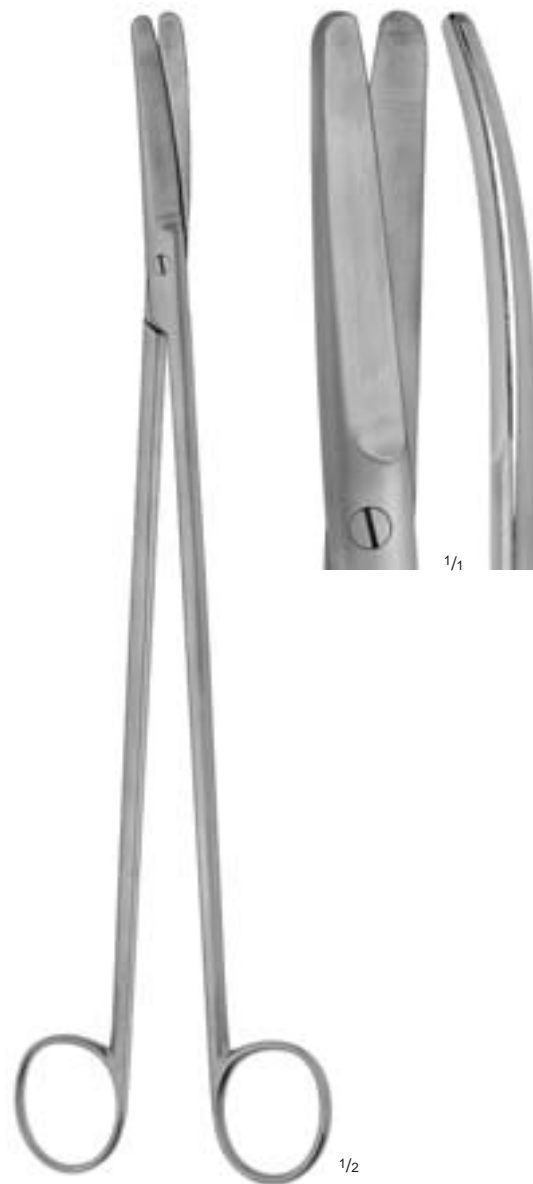

CRAFOORD (STELZNER)

30-0240

30,5 cm, 12"

Lungenlappen- und Rektumschere

Lobectomy and rectal scissors

Tijera para lobectomía y recto

Ciseaux à lobectomie et pour le rectum

Forbici per lobo polmonare e per il retto



Scheren für Neurochirurgie
 Neurosurgical Scissors
 Tijeras para neurocirugía
 Ciseaux pour la neuro-chirurgie
 Forbici per neurochirurgia

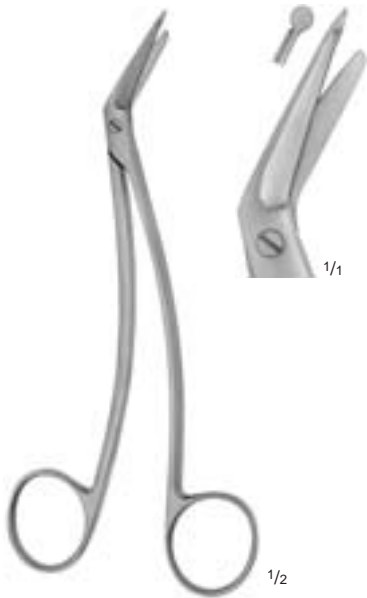

SCHMIEDEN-TAYLOR
50-0400
 15,5 cm, 6"

Duraschere
 Dura scissors
 Tijera para dura-madre
 Ciseaux pour dure-mère
 Forbici per dura madre

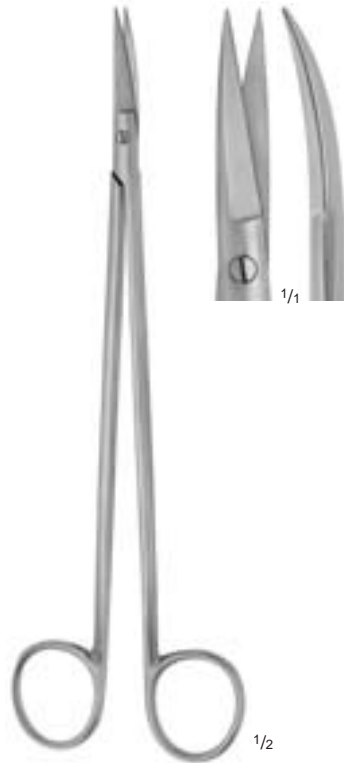

STRULLY
50-0419
 20 cm, 8"

Neurochirurgische Schere
 Scissors for neurosurgery
 Tijera para neurocirugía
 Ciseaux pour la neuro-chirurgie
 Forbici per neurochirurgia

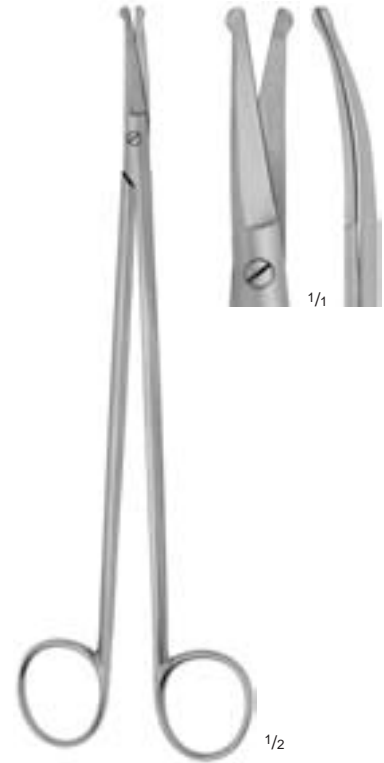

STRULLY
50-0420
 20 cm, 8"

Neurochirurgische Schere
 Scissors for neurosurgery
 Tijera para neurocirugía
 Ciseaux pour la neuro-chirurgie
 Forbici per neurochirurgia



OLIVECRONA
50-0465
 23 cm, 9"

Trigeminal-Schere (auch für Nase),
Arbeitslänge: 140 mm, 5 1/2"

Trigeminal scissors (also nasal),
 working length: 140 mm, 5 1/2"

Tijera para nervio trigémino (también para la
 nariz), longitud útil: 140 mm, 5 1/2"

Ciseaux pour le nerf trigéminal (également pour
 le nez), longueur de tige: 140 mm, 5 1/2"

Forbici per nervo trigemino (anche nasale)
 lunghezza di lavoro: 140 mm, 5 1/2"



KNIGHT
71-0120
 17,5 cm, 7"



1 Blatt gezahnt
 1 blade serrated
 1 hoja dentada
 1 lame dentelée
 1 lama dentata

KNIGHT
71-0122
 17,5 cm, 7"



HEYMANN
71-0100
 17,5 cm, 7"



1 Blatt gezahnt
 1 blade serrated
 1 hoja dentada
 1 lame dentelée
 1 lama dentata

HEYMANN
71-0102
 18,5 cm, 7 1/4"



Nasenscheren
Nasal Scissors
Tijeras nasales
Ciseaux nasaux
Forbici nasali

Septumschere
Septum Scissors
Tijera para el tabique nasal
Ciseaux pour la cloison des fosses nasales
Forbici per il setto nasale



FOMON
76-0630
13,5 cm, 5 1/4"

Nasenschere
Nasal scissors
Tijera nasal
Ciseaux nasaux
Forbici nasali



FOMON
76-0631
13,5 cm, 5 1/4"

Nasenschere, 1 Blatt gezahnt
Nasal scissors, 1 blade serrated
Tijera nasal, 1 hoja dentada
Ciseaux nasaux, 1 lame dentelée
Forbici nasali, 1 lama dentata



COTTLE
76-0640
16 cm, 6 1/4"

Nasenschere
Nasal scissors
Tijera nasal
Ciseaux nasaux
Forbici nasali



MÜHLING (KILLIAN)
76-0650
22 cm, 8 3/4"

Septumschere mit gezahnten Schneiden. Die Übersetzung gewährleistet eine optimale Kraftübertragung auf die Schneiden.

Septum scissors with serrated blades. The double-action ensures optimal power transmission on the blades.

Tijera para el tabique nasal con hojas dentadas. La fuerza de la palanca proporcionan una transmisión de fuerza óptima sobre las puntas cortantes.

Ciseaux pour cloison des fosses nasales avec lames dentelées. La double articulation garanti une transmission de force optimale sur les lames.

Forbici per il setto nasale con taglio dentato. La doppia azione garantisce un'ottimale trasmissione al taglio



Weitere Septumscheren siehe Seite 59.

Further septum scissors see page 59.

Más tijeras para el tabique nasal, vean página 59.

Autres ciseaux pour cloison des fosses nasales voir page 59.

Altre forbici per il setto nasale, vedi pagina 59.

Tonsillenscheren

Tonsil Scissors

Tijeras para amígdalas

Ciseaux pour les amygdales

Forbici per tonsille



1/1

1 Blatt gezahnt
1 blade serrated
1 hoja dentada
1 lame dentelée
1 lama dentata



1/1



1/1



1/2

DEAN
81-0655
17 cm, 6³/₄"



1/2

BOETTCHER
81-0650
18,5 cm, 7¹/₄"



1/2

GOOD
81-0677
19,5 cm, 7³/₄"



Uterusscheren
Uterine Scissors
Tijeras uterinas
Ciseaux utérins
Forbici da utero



▶ **05-0740**
20 cm, 8"



▶ **05-0742**
20 cm, 8"



05-0752
23 cm, 9"

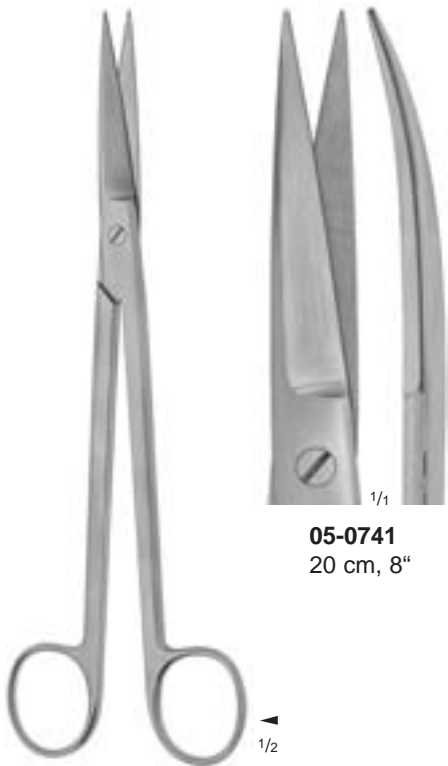

05-0741
20 cm, 8"

SIMS
05-0740
- **05-0741**

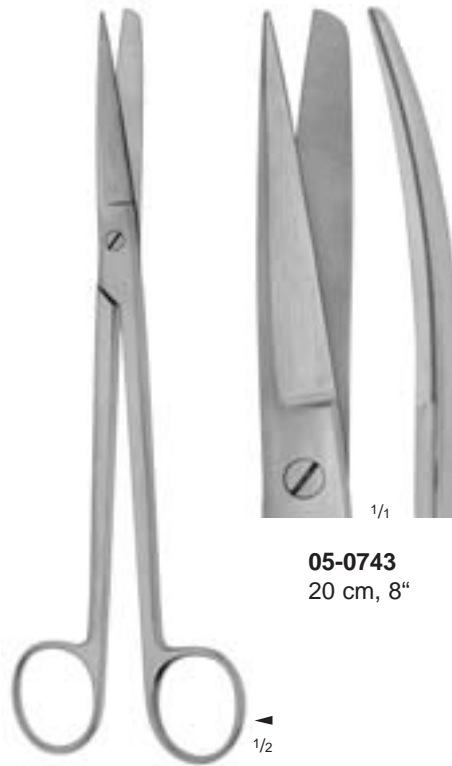

05-0743
20 cm, 8"

SIMS
05-0742
- **05-0753**



05-0753
23 cm, 9"

Uterusscheren
 Uterine Scissors
 Tijeras uterinas
 Ciseaux utérins
 Forbici da utero



► **05-0744**
 20 cm, 8"



05-0754
 23 cm, 9"



► **05-0431**
 20 cm, 8"



05-0745
 20 cm, 8"



05-0755
 23 cm, 9"



05-0433
 23 cm, 9"



SIMS
05-0744
 - **05-0755**



WERTHEIM
05-0431
 - **05-0433**



Uterusscheren

Uterine Scissors
Tijeras uterinas
Ciseaux utérins
Forbici da utero

Bauchdeckenscheren

Abdominal Scissors
Tijeras abdominales
Ciseaux pour interventions en profondeur
Forbici per pareti addominali



SIMS-SIEBOLD
05-0770
24,5 cm, 9³/₄"

Uterusschere
Uterine scissors
Tijera uterina
Ciseaux utérins
Forbici da utero



SIEBOLD
05-0773
24,5 cm, 9³/₄"

Uterusschere
Uterine scissors
Tijera uterina
Ciseaux utérins
Forbici da utero



▶ **05-0780**
18,5 cm, 7¹/₄"



05-0781
18,5 cm, 7¹/₄"

Bauchdeckenscheren

Abdominal scissors
Tijeras abdominales
Ciseaux pour interventions en profondeur
Forbici per pareti addominali

DOYEN
05-0780
- 05-0781

Damm- (Episiotomie-) Scheren

Perineum (Episiotomy) Scissors

Tijeras para perineo (episiotomía)

Ciseaux à périnée (à épisiotomie)

Forbici per perineo (episiotomia)



BRAUN-STADLER
96-0980
- **96-0985**

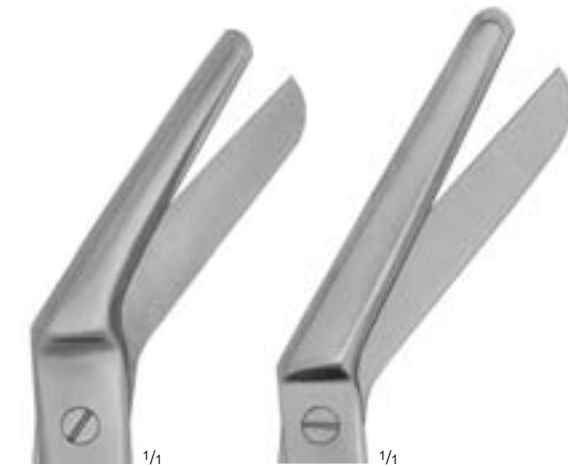

▶ **96-0980**
14,5 cm, 5³/₄"

96-0985
22 cm, 8³/₄"

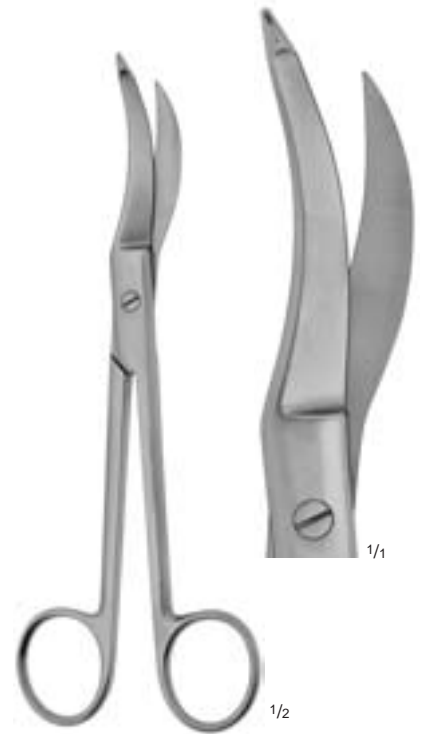

WALDMANN
96-0987
18 cm, 7"

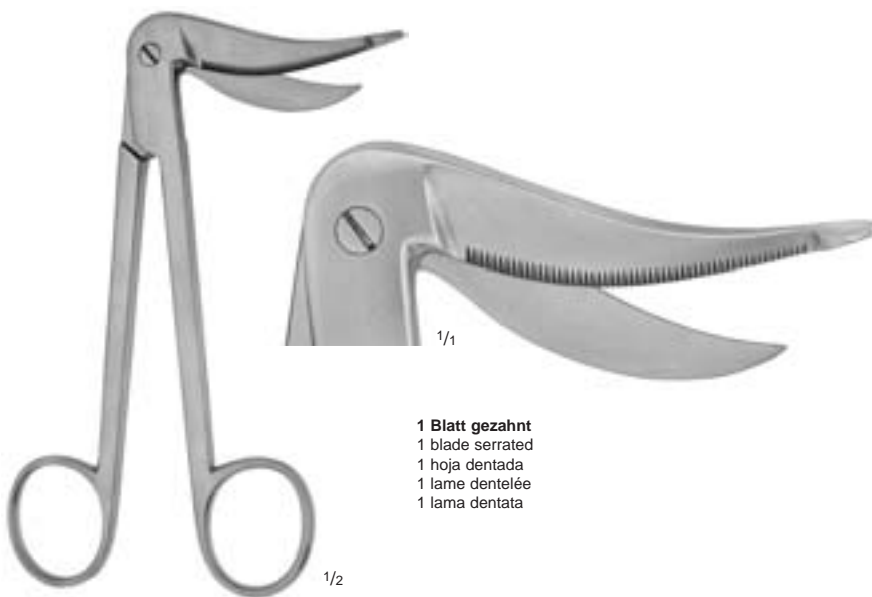

MARBACH
96-0988
15,5 cm, 6"

1 Blatt gezahnt
1 blade serrated
1 hoja dentada
1 lame dentelée
1 lama dentata



96-0989
19,5 cm, 7³/₄"

1 Blatt gezahnt
1 blade serrated
1 hoja dentada
1 lame dentelée
1 lama dentata



Nabelschnurscheren
Umbilical Cord Scissors
Tijeras umbilicales
Ciseaux pour le cordon ombilical
Forbici ombelicali



BUSH
05-0173
16 cm, 6 1/4"



1 Blatt gezahnt
1 blade serrated
1 hoja dentada
1 lame dentelée
1 lama dentata

BUSH
05-0174
16 cm, 6 1/4"



MOD. USA
96-0990
10,5 cm, 4 1/8"



SCHUMACHER
96-0993
15,5 cm, 6"

Kephalotomiescheren

Decapitating Scissors
Tijeras para decapitación
Ciseaux à détroncation
Forbici per decapitazione

Darmscheren

Enterotomy Scissors
Tijeras enterótomos
Ciseaux entérotomes
Forbici per enterotomia



► **97-0435**
27 cm, 10³/₄"



97-0436
27 cm, 10³/₄"

DUBOIS
97-0435
- **97-0436**

Kephalotomiescheren
Decapitating (embryotomy) scissors
Tijeras para decapitación
Ciseaux à détroncation
Forbici per decapitazione



98-0200
21,5 cm, 8¹/₂"

Darmschere für Anatomie
Enterotomy scissors for anatomy
Tijera enterótomo para anatomía
Ciseaux entérotomes pour l'anatomie
Forbici per enterotomia



98-0210
21,5 cm, 8¹/₂"

Darmschere für Anatomie
Enterotomy scissors for anatomy
Tijera enterótomo para anatomía
Ciseaux entérotomes pour l'anatomie
Forbici per enterotomia

**Weitere Scheren**

Further Scissors
 Más tijeras
 Autres ciseaux
 Altre forbici



| | | |
|---|--------------|-----------|
| Nagelhautscheren, Nagelscheren | Seite | 16 |
| Cuticle Scissors, Nail Scissors | Page | 16 |
| Tijeras cuticulares, Tijeras para uñas | Página | 16 |
| Ciseaux à envies, Ciseaux à ongles | Page | 16 |
| Forbici per la cuticola, Forbici per unghie | Pagina | 16 |



| | | |
|---|--------------|------------------------------------|
| DURACUT® Scheren mit Hartmetallschneiden | Seite | 43 - 60, 353, 665, 673, 676 |
| DURACUT® Scissors with tungsten carbide edges | Page | 43 - 60, 353, 665, 673, 676 |
| DURACUT® Tijeras con filos de carburo tungsteno | Página | 43 - 60, 353, 665, 673, 676 |
| DURACUT® Ciseaux avec des lames en tungstène | Page | 43 - 60, 353, 665, 673, 676 |
| DURACUT® Forbici con lame in carburo di tungsteno | Pagina | 43 - 60, 353, 665, 673, 676 |



| | | |
|---|--------------|------------------|
| Ligaturscheren, Fadenscheren | Seite | 352 - 353 |
| Ligature Scissors | Page | 352 - 353 |
| Tijeras para ligaduras | Página | 352 - 353 |
| Ciseaux à ligatures | Page | 352 - 353 |
| Forbici per legature | Pagina | 352 - 353 |



| | | |
|--|--------------|------------|
| Drahtscheren | Seite | 665 |
| Wire Cutting Scissors | Page | 665 |
| Cizallas para cortar alambre | Página | 665 |
| Ciseaux pour couper les fils | Page | 665 |
| Forbici per tagliare i filiferri | Pagina | 665 |



| | | |
|---|--------------|------------------|
| Verband- und Kleiderstoffscheren | Seite | 672 - 675 |
| Bandage and Cloth Scissors | Page | 672 - 675 |
| Tijeras para vendajes y tela | Página | 672 - 675 |
| Ciseaux pour pansements et vêtements | Page | 672 - 675 |
| Forbici per bendaggi e vestiti | Pagina | 672 - 675 |



| | | |
|-------------------------------------|--------------|------------------|
| Gipsscheren | Seite | 675 - 678 |
| Plaster-of-Paris Shears | Page | 675 - 678 |
| Cizallas para yesos | Página | 675 - 678 |
| Cisailles à plâtres | Page | 675 - 678 |
| Cesoie per apparecchi gessati | Pagina | 675 - 678 |



LAWNTON

Medizintechnik



- TITE GRIP® Pinzetten
- TITE GRIP® Forceps
- TITE GRIP® Pinzas
- TITE GRIP® Pincés
- TITE GRIP® Pinze



TITE GRIP® Pinzetten mit Hartmetalleinlagen
 TITE GRIP® Forceps with tungsten carbide inserts
 TITE GRIP® Pinzas con bocas de carburo tungsteno
 TITE GRIP® Pincers avec mors en tungstène
 TITE GRIP® Pinze con morsi in carburo di tungsteno

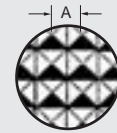

Riefung
 Serration
 Estriadura
 Structure
 Struttura



- Hartmetalleinlagen mit präzis gearbeitetem Pyramidenprofil.
Sicheres und schonendes Fassen von Gefäßen, Gewebe und Nahtmaterial.
Vergoldete Federenden als leichte Kennzeichnung.
- Tungsten carbide inserts with precisely worked out structure.
Firm and gentle grip of vessels, tissues and sutures.
Gold-plated ends for easy identification.
- Capas intermedias de carburo tungsteno con perfil amoldado piramidal que permite un sujeto seguro y cuidadoso de los vasos, tejidos y materiales de sutura.
Identificación: Cabos dorados.
- Mors en tungstène à structure pyramidale.
Préhension sûre et légère des vaisseaux, tissus et sutures
Talon plaqué or pour identification facile.
- Morsi in carburo di tungsteno con struttura piramidale lavorata
Impugnatura più sicura e delicata per vasi, tessuti e suture.
Estremità dorate per una facile identificazione

Je nach Anwendungsgebiet stehen 4 verschiedene Arten von Hartmetalleinlagen zur Verfügung:
 According to the field of application, there are 4 various types of tungsten carbide inserts available:
 Según campo de aplicación, disponemos de 4 diferentes capas intermedias de carburo tungsteno:
 Selon champ d'application, il existe 4 types différents de mors en tungstène:
 A secondo del campo di applicazione Vi sono a disposizione 4 diversi tipi di morsi in carburo di tungsteno

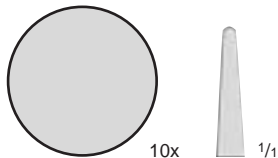
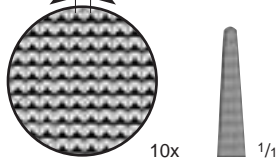
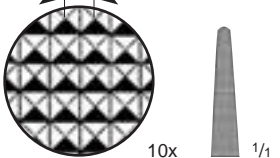
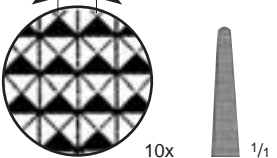
| | 0,2 mm | 0,4 mm | 0,5 mm |
|---|---|--|---|
|  |  |  |  |
| GLATT Zum Halten von extrem feinem Nahtmaterial | TEILUNG 0,2 mm Zum Halten von feinem Nahtmaterial der Stärken 7/0 bis 10/0 | TEILUNG 0,4 mm Zum Halten von Nahtmaterial der Stärken 4/0 bis 6/0 | TEILUNG 0,5 mm Zum Halten von Nahtmaterial der Stärke 3/0 und kräftiger |
| SMOOTH For holding the smallest suture sizes | SERRATION 0,2 mm For holding the delicate suture sizes from 7/0 to 10/0 | SERRATION 0,4 mm For holding the suture sizes from 4/0 to 6/0 | SERRATION 0,5 mm For holding the suture size 3/0 and larger |
| LISA Para sujetar suturas muy finas | ESTRIADURA 0,2 mm Para sujetar suturas finas de 7/0 hasta 10/0 de gruesas | ESTRIADURA 0,4 mm Para sujetar suturas de 4/0 hasta 6/0 de gruesas | ESTRIADURA 0,5 mm Para sujetar suturas de 3/0 y más gruesas |
| LISSE Pour tenir les sutures très fines | STRUCTURE 0,2 mm Pour les sutures fines tailles 7/0 à 10/0 | STRUCTURE 0,4 mm Pour les sutures tailles 4/0 à 6/0 | STRUCTURE 0,5 mm Pour les sutures tailles 3/0 et plus grosses |
| PIATTA Per tenere materiale da sutura estremamente sottile | STRUTTURA 0,2 mm Per tenere suture sottile dello spessore da 7/0 a 10/0 | STRUTTURA 0,4 mm Per tenere suture dello spessore da 4/0 a 6/0 | STRUTTURA 0,5 mm Per tenere suture dello spessore da 3/0 e più robuste |

TITE GRIP® Anatomische Pinzetten mit Hartmetalleinlagen
 TITE GRIP® Dissecting Forceps with tungsten carbide inserts
 TITE GRIP® Pinzas de disección con bocas de carburo tungsteno
 TITE GRIP® Pincès à dissection avec mors en tungstène
 TITE GRIP® Pinze anatomiche per dissezione con morsi in carburo di tungsteno

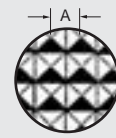

Riefung
 Serration
 Estriadura
 Structure
 Struttura



ADSON
 09-1375
 - 09-1378



0,4 mm (A)
 ▶ 09-1376
 12 cm, 4^{3/4}"



0,5 mm (A)
 09-1377
 15 cm, 6"



ADSON
 09-1379
 12 cm, 4^{3/4}"



0,4 mm (A)



SEMKEN
 09-1559
 15 cm, 6"

mit Dissektor-Ende
 with dissector end
 con cabo disecador
 avec dissecteur
 con estremità per dissezione

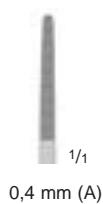

0,4 mm (A)



MC INDOE
 09-1380
 15 cm, 6"



0,4 mm (A)



OBWEGESER
 09-1382
 16 cm, 6^{1/4}"

Knüpfpinzette
 Suture tying forceps
 Pinza de ligadura
 Pince à ligatures
 Pinza per legature



0,2 mm (A)



OBWEGESER
 09-1384
 18 cm, 7"

Knüpfpinzette
 Suture tying forceps
 Pinza de ligadura
 Pince à ligatures
 Pinza per legature



0,2 mm (A)



TITE GRIP® Anatomische Pinzetten mit Hartmetalleinlagen
 TITE GRIP® Dissecting Forceps with tungsten carbide inserts
 TITE GRIP® Pinzas de disección con bocas de carburo tungsteno
 TITE GRIP® Pincès à dissection avec mors en tungstène
 TITE GRIP® Pinze anatomiche per dissezione con morsi in carburo di tungsteno

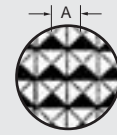

Riefung
 Serration
 Estradadura
 Structure
 Struttura



GERALD
 09-1386
 17,5 cm, 7"



CUSHING
 09-1740
 17,5 cm, 7"
 mit Dissektor-Ende
 with dissector end
 con cabo disecador
 avec dissecteur
 con estremità per dissezione







CUSHING
 09-1741
 17,5 cm, 7"
 mit Dissektor-Ende
 with dissector end
 con cabo disecador
 avec dissecteur
 con estremità per dissezione



TAYLOR-CUSHING
 09-1710
 18,5 cm, 7 1/4"
 mit Dissektor-Ende
 with dissector end
 con cabo disecador
 avec dissecteur
 con estremità per dissezione



POTTS-SMITH
 09-1574
 - 09-1591

| | | | | |
|---|---|---|---|---|
|  |  |  |  |  |
| 0,4 mm (A) | 0,4 mm (A) | 0,4 mm (A) | 0,4 mm (A) | 0,4 mm (A) |
| 09-1574 16 cm, 6 1/4" | ▶ 09-1576 18,5 cm, 7 1/4" | 09-1581 21 cm, 8 1/4" | 09-1586 24,5 cm, 9 3/4" | 09-1591 26 cm, 10 1/4" |

mit Dissektor-Ende • with dissector end • con cabo disecador • avec dissecteur • con estremità per dissezione

TITE GRIP® Anatomische Pinzetten mit Hartmetalleinlagen
 TITE GRIP® Dissecting Forceps with tungsten carbide inserts
 TITE GRIP® Pinzas de disección con bocas de carburo tungsteno
 TITE GRIP® Pincès à dissection avec mors en tungstène
 TITE GRIP® Pinze anatomiche per dissezione con morsi in carburo di tungsteno

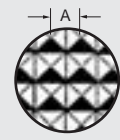

Riefung
 Serration
 Estriadura
 Structure
 Struttura



| | | | | | | |
|--|---------------|-----------------|---------------|------------|------------|------------|
| | | | | | | |
| | 0,5 mm (A) | 0,5 mm (A) | 0,5 mm (A) | 0,5 mm (A) | 0,5 mm (A) | 0,5 mm (A) |
| | 09-1116 | 09-1121 | 09-1126 | ▶ 09-1131 | 09-1136 | 09-1141 |
| | 13 cm, 5 1/8" | 14,5 cm, 5 3/4" | 16 cm, 6 1/4" | 18 cm, 7" | 20 cm, 8" | 25 cm, 10" |

Standard Modelle • Standard patterns • modelos standard • modèles standard • modelli standard

09-1116
 - 09-1141

| | | | |
|--|------------|------------|--------------|
| | | | |
| | 0,5 mm (A) | 0,5 mm (A) | 0,5 mm (A) |
| | 09-1800 | ▶ 09-1802 | 09-1804 |
| | 15 cm, 6" | 23 cm, 9" | 25,5 cm, 10" |

BONNEY
 09-1145
 17 cm, 6 3/4"

WANGENSTEEN
 09-1800
 - 09-1804



TITE GRIP® Gewebefaß- und Nadelzieh-Pinzetten
 TITE GRIP® Needlepulling Tissue Forceps
 TITE GRIP® Pinzas para tejidos y tirar uñas
 TITE GRIP® Pincés pour saisir les tissus et tirer les aiguilles
 TITE GRIP® Pinze per tessuti e per infilare aghi

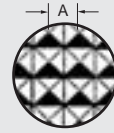

Riefung
 Serration
 Estradura
 Structure
 Struttura

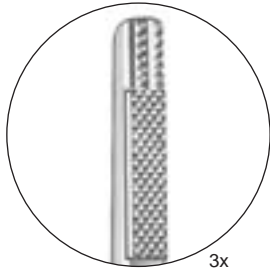

3x

1,5 mm



1/1

0,2 mm (A)

09-1051
 15,5 cm, 6"

1,5 mm



1/1

0,2 mm (A)

09-1061
 20 cm, 8"

1,5 mm



1/1

0,2 mm (A)

09-1071
 24 cm, 9 1/2"



1/2

2 mm



1/1

0,4 mm (A)

09-1050
 15,5 cm, 6"

2 mm



1/1

0,4 mm (A)

▶ 09-1060
 20 cm, 8"

2 mm



1/1

0,4 mm (A)

09-1070
 24 cm, 9 1/2"

DE BAKEY
 09-1050
 - 09-1071

Mit der atraumatischen Riefung am vorderen Maulende wird feines Gewebe schonend und sicher gefaßt, während mit den dahinterliegenden Hartmetalleinlagen eine Wundnadel sicher gehalten werden kann.

With the atraumatic jaws at the tips, fine tissues are hold gently and in a secure way. The tungsten carbide inserts provide safe gripping of needle.

Con la estradura atraumatica en la parte delantera de la boca, se sujeta cuidadoso y seguro tejido fino, mientras que con las capas intermedias de carburo tungsteno detrás se puede sujetar seguro una aguja.

Avec la striure atraumatique à l'extrémité des mors, les tissus fins sont saisis d'une manière délicate et ferme. Les mors en tungstène assurent une très bonne tenue de l'aiguille.

La pinza si presenta con una scanalatura atraumatica all'estremità anteriore. Ha la capacità di afferrare un tessuto in modo delicato e sicuro ed inoltre le sue estremità a morsi in carburo di tungsteno consentono di tenere fermo un ago da sutura.

TITE GRIP® Chirurgische Pinzetten mit Hartmetalleinlagen
 TITE GRIP® Tissue Forceps with tungsten carbide inserts
 TITE GRIP® Pinzas quirúrgicas con bocas de carburo tungsteno
 TITE GRIP® Pincès à dissection à griffes avec mors en tungstène
 TITE GRIP® Pinze per dissezione con denti con morsi in carburo di tungsteno

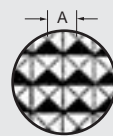

Riefung
 Serration
 Estriadura
 Structure
 Struttura

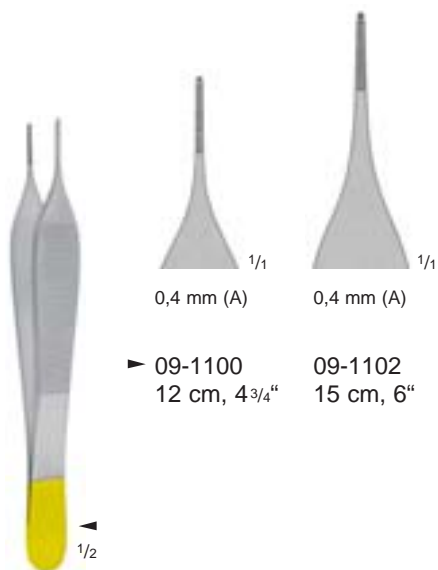

► 09-1100 09-1102
 12 cm, 4 3/4" 15 cm, 6"

MICRO-ADSON
 09-1100
 - 09-1102

1x2 Zähne
 1x2 teeth
 1x2 dientes
 1x2 dents
 1x2 denti

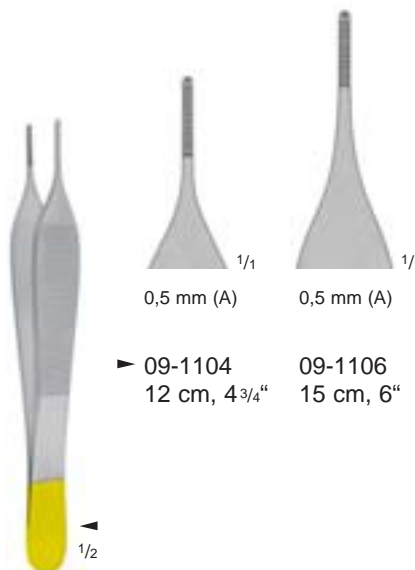

► 09-1104 09-1106
 12 cm, 4 3/4" 15 cm, 6"

ADSON
 09-1104
 - 09-1106

1x2 Zähne
 1x2 teeth
 1x2 dientes
 1x2 dents
 1x2 denti

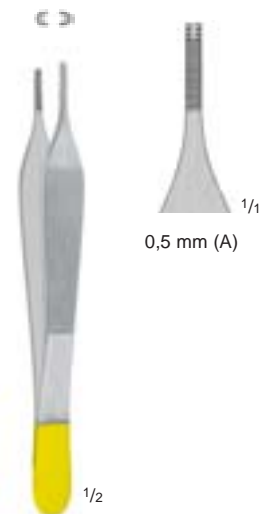

ADSON-BROWN
 09-1110
 12 cm, 4 3/4"

3x4 Zähne
 3x4 teeth
 3x4 dientes
 3x4 dents
 3x4 denti

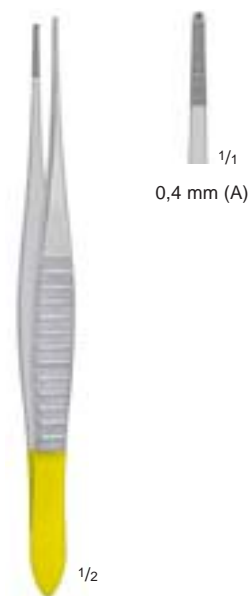

GILLIES
 09-1112
 15 cm, 6"

1x2 Zähne
 1x2 teeth
 1x2 dientes
 1x2 dents
 1x2 denti



09-1118 ► 09-1120
 16 cm, 6 1/4" 18 cm, 7"

SEMKEN
 09-1118
 - 09-1120

1x2 Zähne
 1x2 teeth
 1x2 dientes
 1x2 dents
 1x2 denti



GERALD
 09-1122
 17,5 cm, 7"

1x2 Zähne
 1x2 teeth
 1x2 dientes
 1x2 dents
 1x2 denti



TITE GRIP® Pinzetten mit Hartmetalleinlagen
 TITE GRIP® Forceps with tungsten carbide inserts
 TITE GRIP® Pinzas con bocas de carburo tungsteno
 TITE GRIP® Pincers avec mors en tungstène
 TITE GRIP® Pinze con morsi in carburo di tungsteno

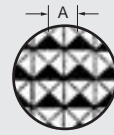

Riefung
 Serration
 Estradadura
 Structure
 Struttura



1/2

OEHLER
 09-1161
 - 09-1181

Chirurgische Pinzetten, 1x2 Zähne
 Tissue forceps, 1x2 teeth
 Pinzas quirúrgicas, 1x2 dientes
 Pincers à dissection à griffes, 1x2 dents
 Pinze chirurgiche a denti di topo, 1x2 denti



1/1
 0,5 mm (A)

09-1161
 14,5 cm, 5 3/4"



1/1
 0,5 mm (A)

09-1168
 16 cm, 6 1/4"



1/1
 0,5 mm (A)

► 09-1171
 18 cm, 7"



1/1
 0,5 mm (A)

09-1176
 20,5 cm, 8"



1/1
 0,5 mm (A)

09-1181
 25 cm, 10"



1/2

BONNEY
 09-1185
 17,5 cm, 7"

Chirurgische Pinzetten, 1x2 Zähne
 Tissue forceps, 1x2 teeth
 Pinzas quirúrgicas, 1x2 dientes
 Pincers à dissection à griffes, 1x2 dents
 Pinze chirurgiche a denti di topo, 1x2 denti



1/1
 0,5 mm (A)



1/2

57-0325
 21,5 cm, 8 1/2"

Mikro-Pinzette
 Micro forceps
 Micro-Pinza
 Micro-Pince
 Micro-Pinza



1/1
 glatt
 smooth
 liso
 lisse
 piatta



1/2

57-0365
 21,5 cm, 8 1/2"

Mikro-Pinzette
 Micro forceps
 Micro-Pinza
 Micro-Pince
 Micro-Pinza

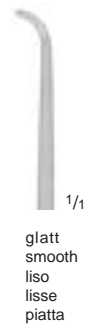

1/1
 glatt
 smooth
 liso
 lisse
 piatta



LAWNTON

Medizintechnik



Pinzetten
Forceps
Pinzas
Pinces
Pinze



Mikro-Pinzetten (Uhrmacher-Modelle)
 Micro Forceps (Jeweler Patterns)
 Micro-pinzas (modelos de relojero)
 Micro-pinces (modèles horloger)
 Micro-pinze (modello orologiaio)

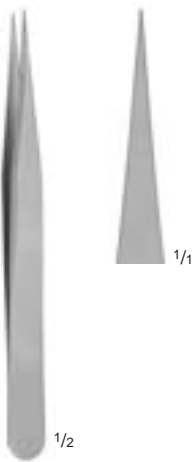

Fig. 1

MOD. SWITZERLAND
 09-0950
 12 cm, 4^{3/4}"

feine Spitzen
 fine points
 puntas finas
 pointes fines
 punte fini

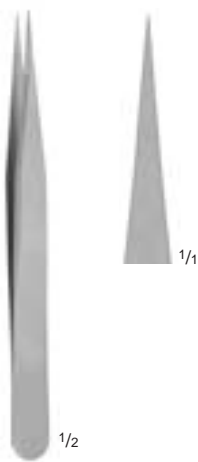

Fig. 3

MOD. SWITZERLAND
 09-0952
 12 cm, 4^{3/4}"

extra feine Spitzen
 extra fine points
 puntas extra finas
 pointes très fines
 punte extra fini

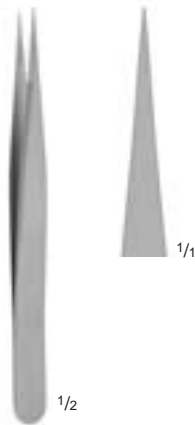

Fig. 3c

MOD. SWITZERLAND
 09-0954
 11 cm, 4^{3/8}"

extra feine Spitzen
 extra fine points
 puntas extra finas
 pointes très fines
 punte extra fini

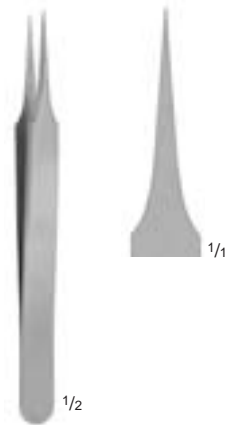

Fig. 4

MOD. SWITZERLAND
 09-0956
 11 cm, 4^{3/8}"

extra feine Spitzen
 extra fine points
 puntas extra finas
 pointes très fines
 punte extra fini

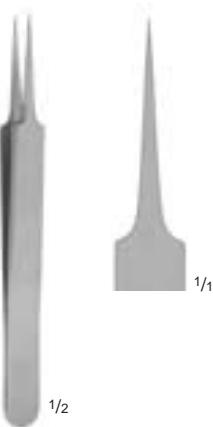

Fig. 5

MOD. SWITZERLAND
 09-0958
 11 cm, 4^{3/8}"

superfeine Spitzen
 super fine points
 puntas super finas
 pointes superfines
 punte super fini

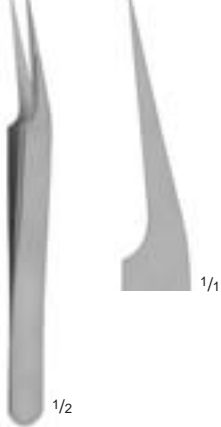

Fig. 5a

MOD. SWITZERLAND
 09-0955
 11,5 cm, 4^{1/2}"

feine Spitzen
 fine points
 puntas finas
 pointes fines
 punte fini

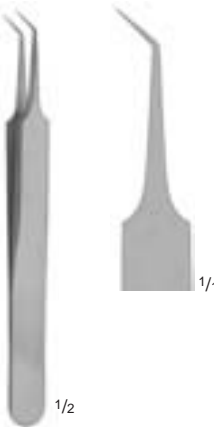

Fig. 5s

MOD. SWITZERLAND
 09-0957
 11 cm, 4^{3/8}"

superfeine Spitzen
 super fine points
 puntas super finas
 pointes superfines
 punte super fini

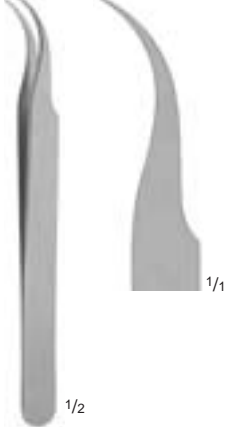

Fig. 7

MOD. SWITZERLAND
 09-0959
 11,5 cm, 4^{1/2}"

feine Spitzen
 fine points
 puntas finas
 pointes fines
 punte fini

Mikroskopier-Pinzetten
 Microscopic Forceps
 Pinzas para microscopia
 Pincès pour microscopie
 Pinze per microscopia

Mikro-Knüpfpinzetten
 Micro Suture Tying Forceps
 Micro-pinzas de ligadura
 Micro-pincès à ligatures
 Micro-pinze per legature

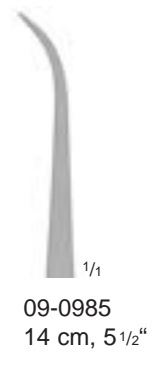
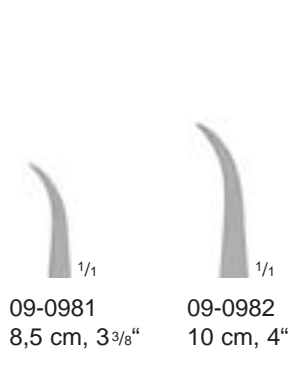
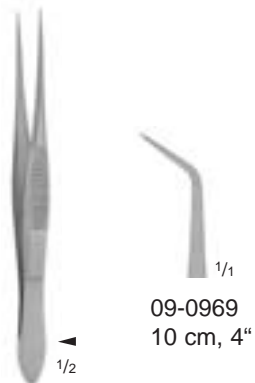
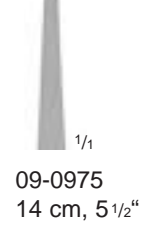
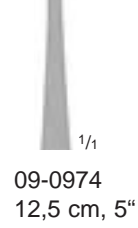
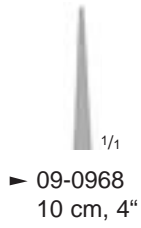

09-0968
 - 09-0969

09-0971
 - 09-0985

Mikroskopier-Pinzetten • Microscopic forceps • Pinzas para microscopia • Pincès pour microscopie • Pinze per microscopia

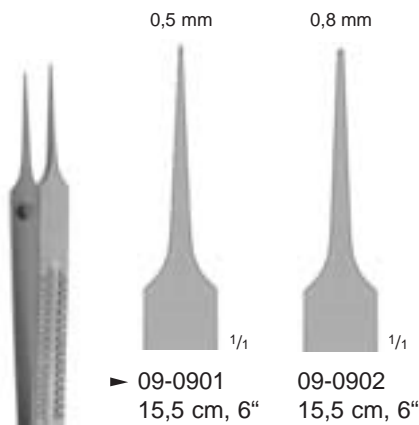

LAZAR
 09-0901
 - 09-0902

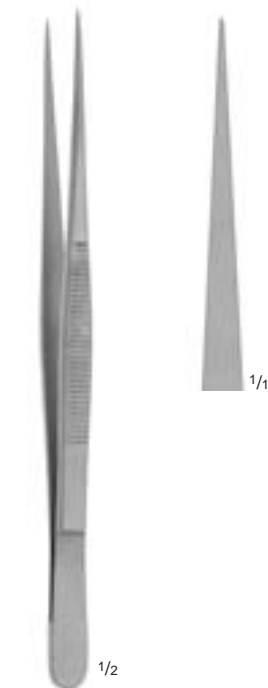

09-0903
 18 cm, 7"

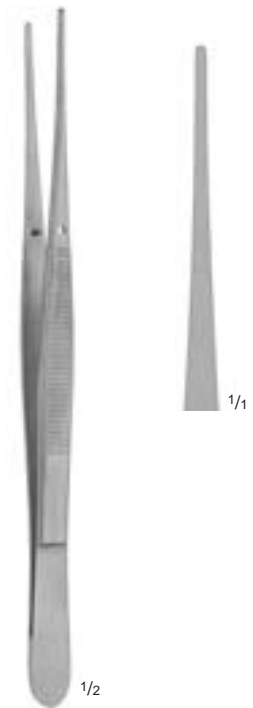

09-0232
 18 cm, 7"

Mikro-Knüpfpinzetten • Micro suture tying forceps • Micro-pinzas de ligadura • Micro-pincès à ligatures • Micro-pinze per legature



Mikro-Knüpfpinzetten mit Flachgriffen
 Micro Suture Tying Forceps with Flat Handles
 Micro-pinzas de ligadura con mangos planos
 Micro-pinces à ligatures avec manches plats
 Micro-pinze per legature con manici piatti

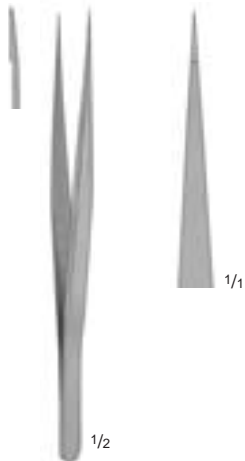

09-3000
 12 cm, 4^{3/4}"

mit glatten Fadenplatten
 with smooth tying platforms
 con plataformas lisas
 avec plateaux lisses à ligatures
 con piattaforme lisce

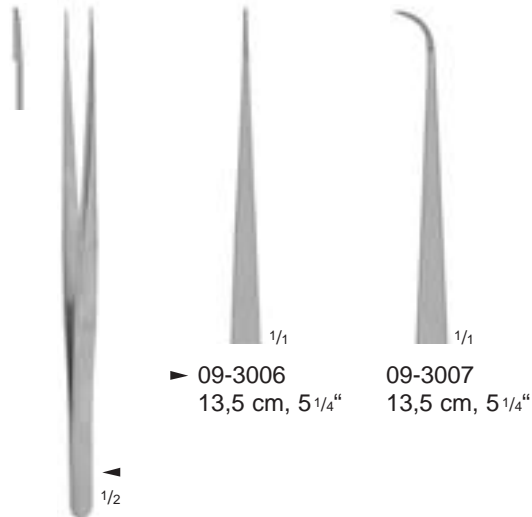

► 09-3006 13,5 cm, 5^{1/4}"
 09-3007 13,5 cm, 5^{1/4}"

VISE
 09-3006
 - 09-3007

mit glatten Fadenplatten
 with smooth tying platforms
 con plataformas lisas
 avec plateaux lisses à ligatures
 con piattaforme lisce

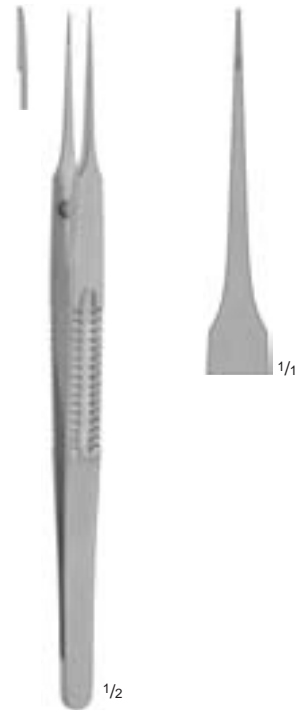

09-3010
 18,5 cm, 7^{1/4}"

mit glatten Fadenplatten
 with smooth tying platforms
 con plataformas lisas
 avec plateaux lisses à ligatures
 con piattaforme lisce

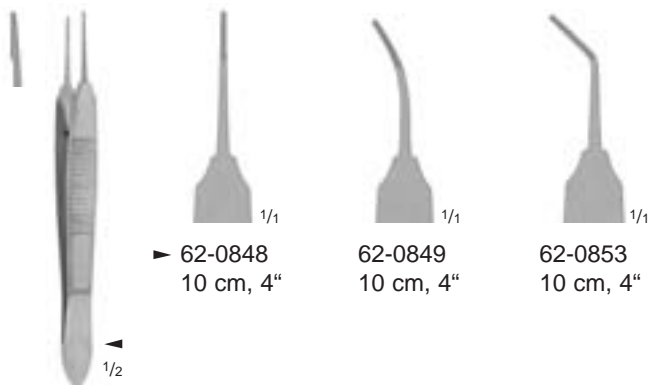

► 62-0848 10 cm, 4"
 62-0849 10 cm, 4"
 62-0853 10 cm, 4"

MC PHERSON
 62-0848
 - 62-0853

mit glatten Fadenplatten
 with smooth tying platforms
 con plataformas lisas
 avec plateaux lisses à ligatures
 con piattaforme lisce

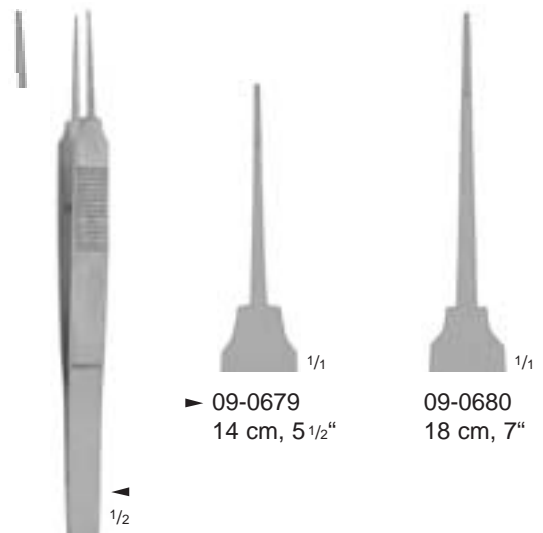

► 09-0679 14 cm, 5^{1/2}"
 09-0680 18 cm, 7"

AUSTIN
 09-0679
 - 09-0680

mit glatten Fadenplatten
 with smooth tying platforms
 con plataformas lisas
 avec plateaux lisses à ligatures
 con piattaforme lisce

Mikro-Knüppfzangen mit Rundgriffen
 Micro Suture Tying Forceps with Round Handles
 Micro-pinzas de ligadura con mangos redondos
 Micro-pinces à ligatures avec manches ronds
 Micro-pinze per legature con manici rotondi

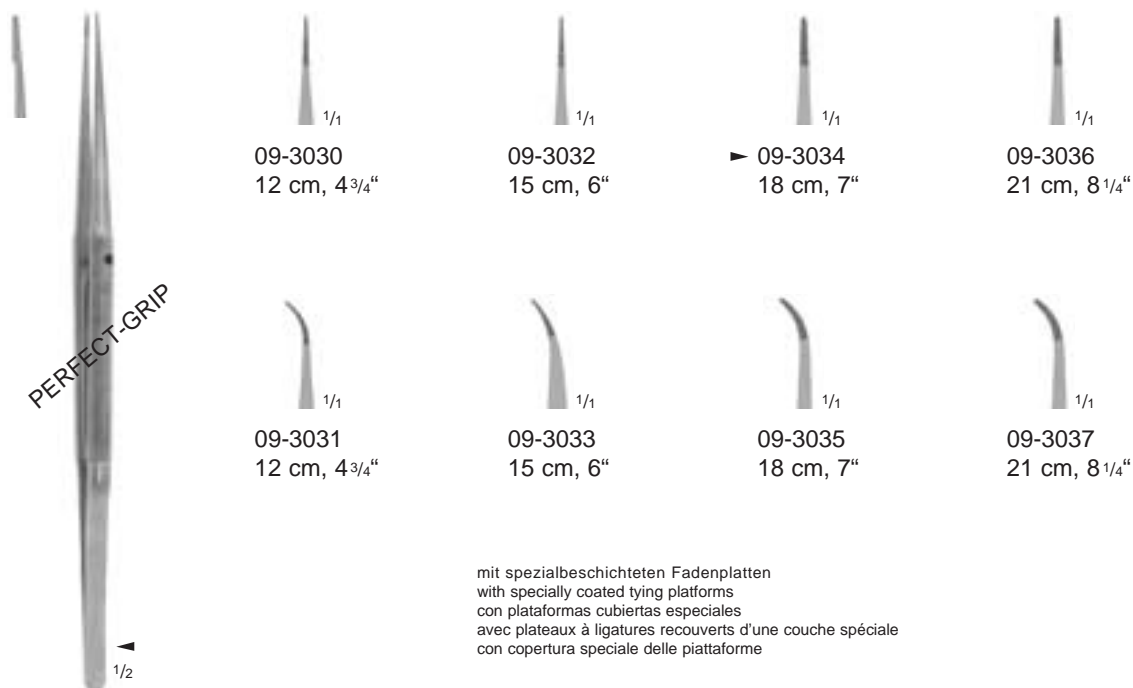

09-3030
 - 09-3037

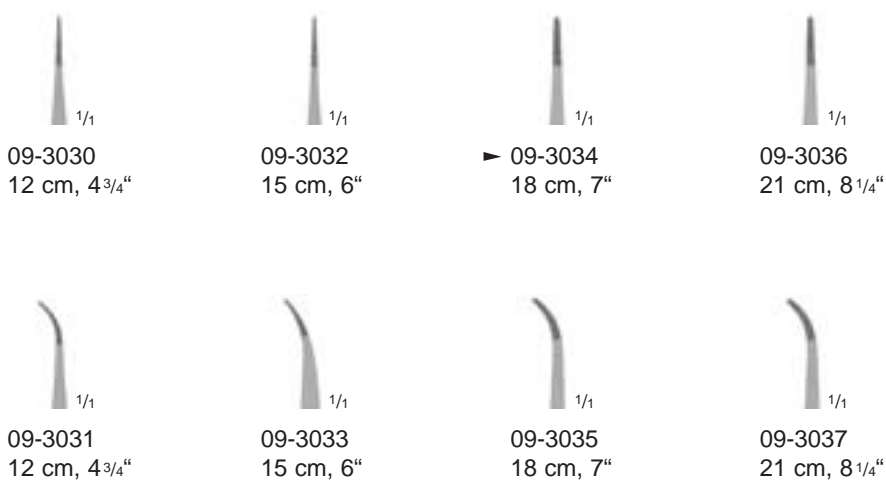

mit spezialbeschichteten Fadenplatten
 with specially coated tying platforms
 con plataformas cubiertas especiales
 avec plateaux à ligatures recouverts d'une couche spéciale
 con copertura speciale delle piattaforme

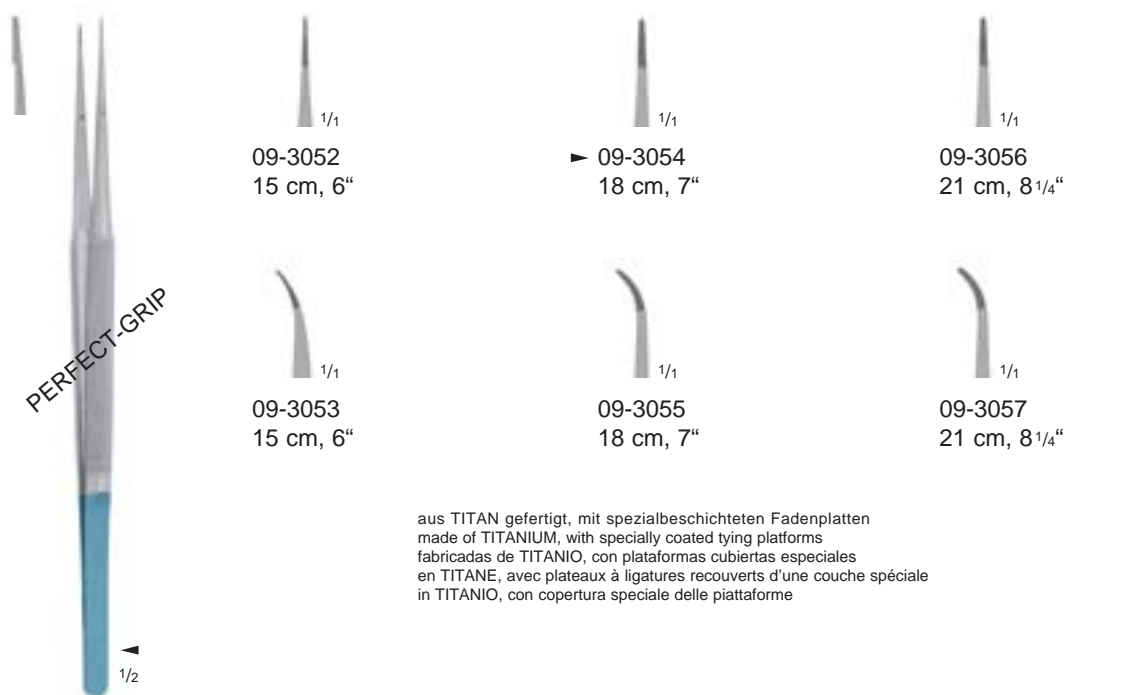

09-3052
 - 09-3057

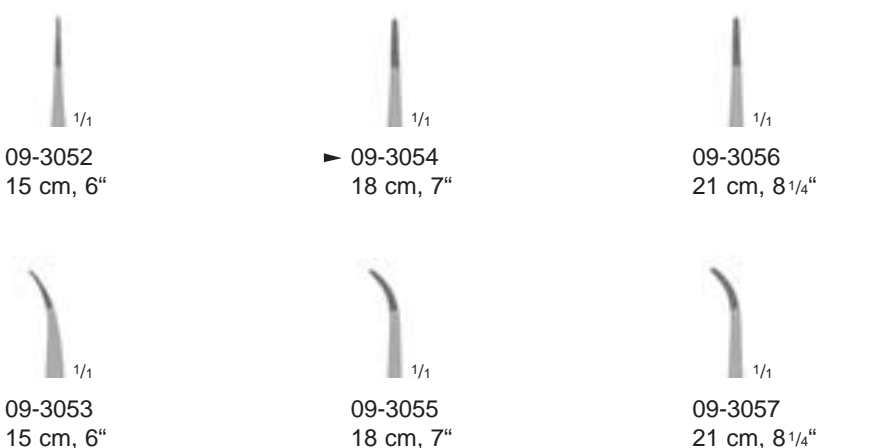

aus TITAN gefertigt, mit spezialbeschichteten Fadenplatten
 made of TITANIUM, with specially coated tying platforms
 fabricadas de TITANIO, con plataformas cubiertas especiales
 en TITANE, avec plateaux à ligatures recouverts d'une couche spéciale
 in TITANIO, con copertura speciale delle piattaforme



Mikro-Faßpinzetten mit Rundgriffen
 Micro Grasping Forceps with Round Handles
 Micro-pinzas de agarre con mangos redondos
 Micro-pinces pour saisir les tissus avec des manches ronds
 Micro-pinze per afferrare tessuti con manici rotondi



mit glatten Fadenplatten,
1x2 Zähne
 with smooth tying plat-
forms, 1x2 teeth
 con piattaforme lisas,
1x2 dientes
 avec plateaux lisses à
ligatures, 1x2 dents
 con piattaforme lisce,
1x2 denti

09-3062
18 cm, 7"



mit DE BAKEY-Zahnung
 with toothing DE BAKEY
 con dentado DE BAKEY
 avec mors DE BAKEY
 con dentatura DE BAKEY

09-3064
18 cm, 7"



aus TITAN gefertigt,
mit DE BAKEY-Zahnung
 made of TITANIUM,
with toothing DE BAKEY
 fabricada de TITANIO,
con dentado DE BAKEY
 en TITANE,
avec mors DE BAKEY
 in TITANO,
con dentatura DE BAKEY

09-3066
18 cm, 7"

1 mm 1 mm 1 mm

09-3132 09-3134 09-3136
15 cm, 6" 18 cm, 7" 21 cm, 8 1/4"

2 mm 2 mm 2 mm

09-3142 09-3144 09-3146
15 cm, 6" 18 cm, 7" 21 cm, 8 1/4"

mit spezialbeschichteten Maulteilen
 with specially coated jaws
 con bocas cubiertas especiales
 avec mors recouverts d'une couche spéciale
 con copertura speciale dei morsi

09-3132
- 09-3146

1 mm 1 mm 1 mm

09-3172 09-3174 09-3176
15 cm, 6" 18 cm, 7" 21 cm, 8 1/4"

2 mm 2 mm 2 mm

09-3182 09-3184 09-3186
15 cm, 6" 18 cm, 7" 21 cm, 8 1/4"

aus TITAN gefertigt, mit spezialbeschichteten Maulteilen
 made of TITANIUM, with specially coated jaws
 fabricadas de TITANIO, con bocas cubiertas especiales
 en TITANE, avec mors recouverts d'une couche spéciale
 in TITANIO, con copertura speciale dei morsi

09-3172
- 09-3186

Mikro-Pinzetten, bajonettförmig
 Micro Forceps, bayonet-shaped
 Micro-pinzas, en forma bayoneta
 Micro-pinces en forme de baïonnette
 Micro-pinze con manici a baionetta



0,4 mm



► 57-1110
 18 cm, 7"

0,4 mm



57-1112
 20 cm, 8"

0,4 mm



57-1114
 22 cm, 8^{3/4}"

0,4 mm



57-1116
 24,5 cm, 9^{3/4}"

0,9 mm



57-1120
 18 cm, 7"

0,9 mm



57-1122
 20 cm, 8"

0,9 mm



57-1124
 22 cm, 8^{3/4}"

0,9 mm



57-1126
 24,5 cm, 9^{3/4}"



YASARGIL
 57-1110
 - 57-1126

mit glatten Maulteilen
 with smooth jaws
 con bocas lisas
 avec mors lisses
 con morsi lisci

0,4 mm



YASARGIL
 57-1130
 18 cm, 7"

1x2 Zähne
 1x2 teeth
 1x2 dientes
 1x2 dents
 1x2 denti



Tumor- und Gewebefaßpinzetten, bajonettförmig
 Tumor and Tissue Grasping Forceps, bayonet-shaped
 Pinzas de agarre para tejido y tumor, en forma bayoneta
 Pincers en forme de baïonnette pour saisir tumeurs et tissus
 Pinze per afferare tessuti e tumori, a baionetta

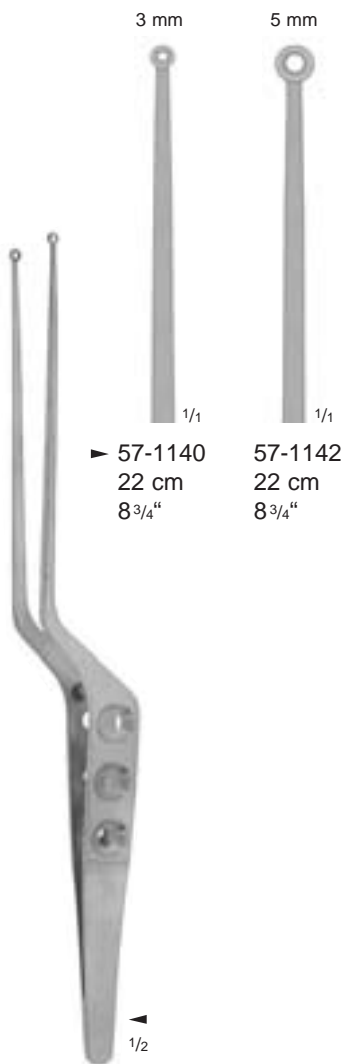

YASARGIL
 57-1140
 - 57-1142

Maul löffelförmig
 jaws spoon-shaped
 boca forma cuchara
 Mors en forme de cuillère
 Morsi a forma di cucchiaio

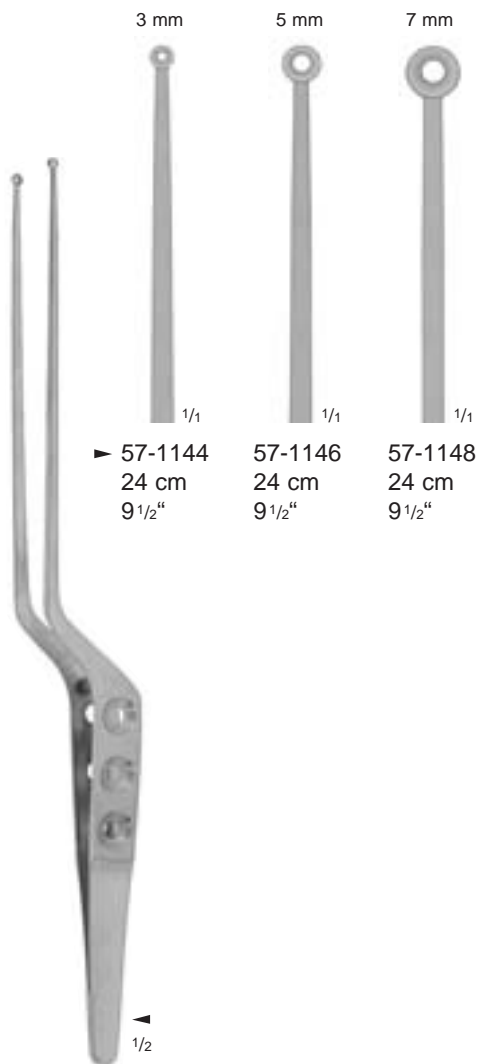

YASARGIL-SAMII
 57-1144
 - 57-1148

Maul löffelförmig
 jaws spoon-shaped
 boca forma cuchara
 Mors en forme de cuillère
 Morsi a forma di cucchiaio

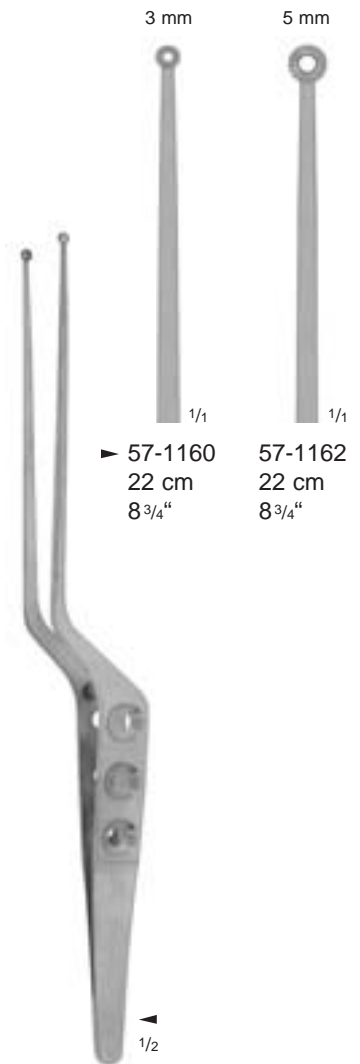

YASARGIL
 57-1160
 - 57-1162

Maul flach, gezahnt
 flat jaws, serrated
 boca plana, dentada
 Mors plats, dentelés
 Morsi piatti, dentati

Tumor- und Gewebefaßpinzetten, bajonettförmig
 Tumor and Tissue Grasping Forceps, bayonet-shaped
 Pinzas de agarre para tejido y tumor, en forma bayoneta
 Pincers en forme de baïonnette pour saisir tumeurs et tissus
 Pinze per afferare tessuti e tumori, a baionetta

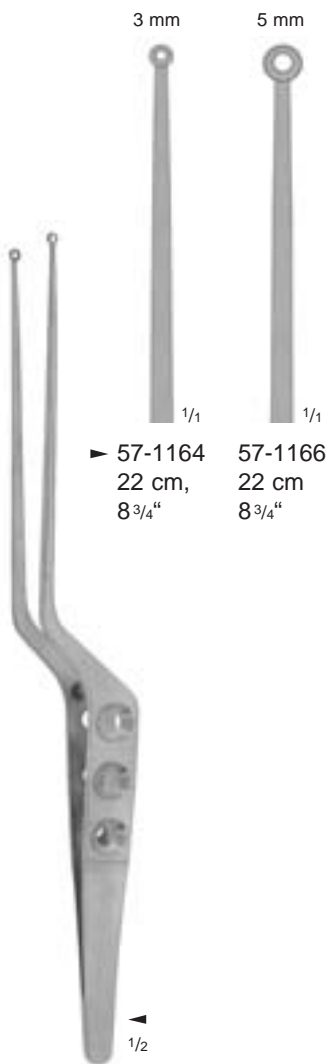

▶ 57-1164 22 cm, 8 3/4"
 ▶ 57-1166 22 cm 8 3/4"

HEIFETZ
 57-1164
 - 57-1166

Maul kürettenförmig, gezahnt
 curette jaws, toothed
 boca forma cureta, dentada
 Mors en forme de curette, dentelés
 Morsi a forma di curetta, dentati

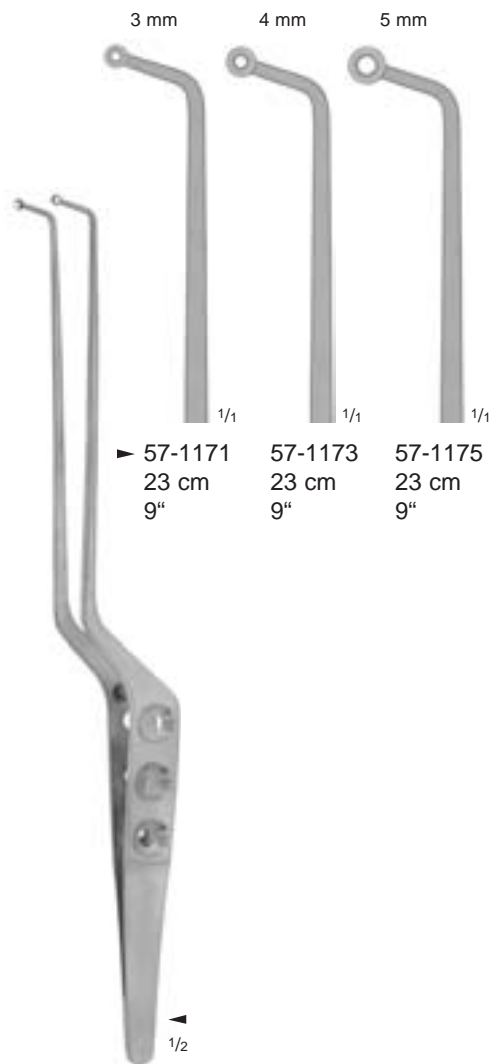

▶ 57-1171 23 cm 9"
 ▶ 57-1173 23 cm 9"
 ▶ 57-1175 23 cm 9"

SAMII
 57-1171
 - 57-1175

Maul löffelförmig
 jaws spoon-shaped
 boca forma cuchara
 Mors en forme de cuillère
 Morsi a forma di cucchiaio

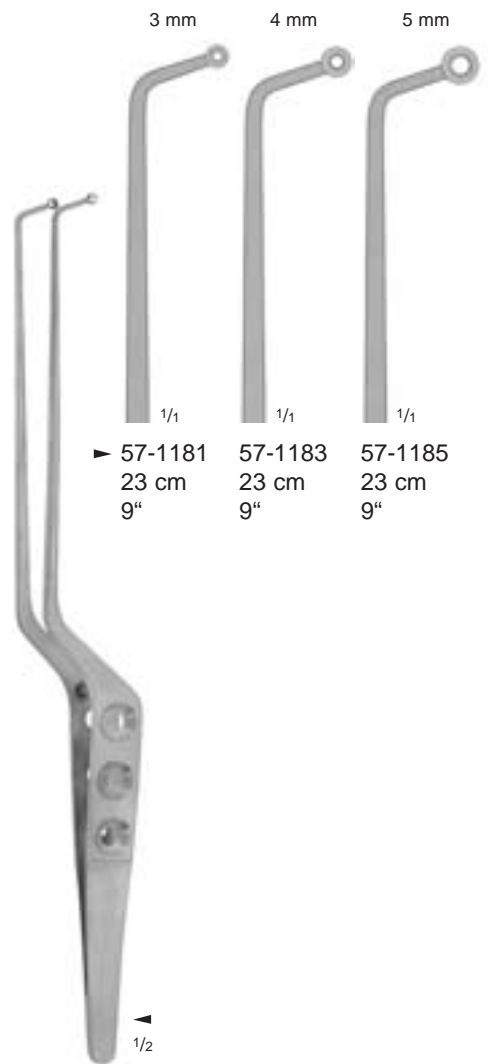

▶ 57-1181 23 cm 9"
 ▶ 57-1183 23 cm 9"
 ▶ 57-1185 23 cm 9"

SAMII
 57-1181
 - 57-1185

Maul löffelförmig
 jaws spoon-shaped
 boca forma cuchara
 Mors en forme de cuillère
 Morsi a forma di cucchiaio



Feine anatomische Pinzetten
 Delicate Dissecting Forceps
 Pinzas finas de disección
 Pincas fines pour dissection
 Pinze anatomiche per dissezione, fini

0,3 mm



09-0006
10 cm, 4"

0,5 mm



▶ 09-0016
10 cm, 4"

1,0 mm



09-0010
10 cm, 4"

0,5 mm



62-0251
7 cm, 2 3/4"

0,7 mm



▶ 62-0261
7 cm, 2 3/4"

1,0 mm



62-0271
7 cm, 2 3/4"

0,3 mm



09-0007
10 cm, 4"

0,5 mm



09-0017
10 cm, 4"

1,0 mm



09-0011
10 cm, 4"

0,5 mm



62-0253
7 cm, 2 3/4"

0,7 mm



62-0263
7 cm, 2 3/4"

1,0 mm



62-0273
7 cm, 2 3/4"



GRAEFE
62-0251
- 62-0273

0,3 mm



09-0009
9,5 cm, 3 3/4"

0,5 mm



09-0019
9,5 cm, 3 3/4"

1,0 mm



09-0013
9,5 cm, 3 3/4"



09-0006
- 09-0019

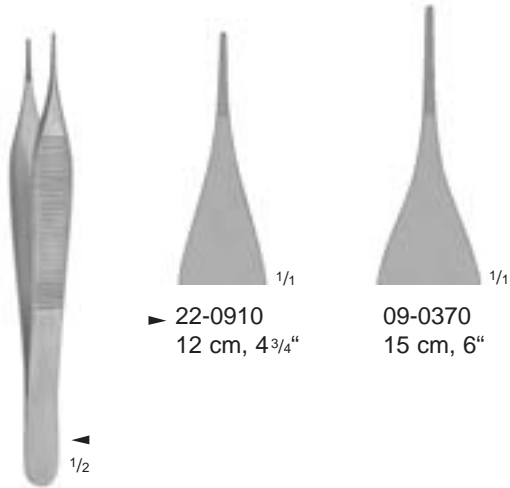

▶ 22-0910
12 cm, 4^{3/4}"

09-0370
15 cm, 6"

MICRO-ADSON
09-0370
- 22-0910

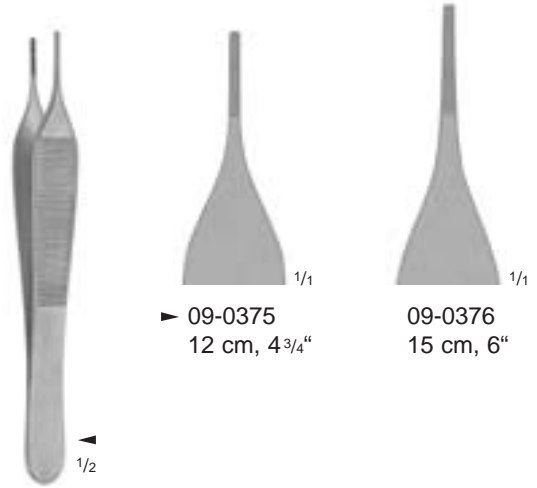

▶ 09-0375
12 cm, 4^{3/4}"

09-0376
15 cm, 6"

ADSON
09-0375
- 09-0376



ADSON
09-0378
12 cm, 4^{3/4}"



EWALD
09-0395
12 cm, 4^{3/4}"

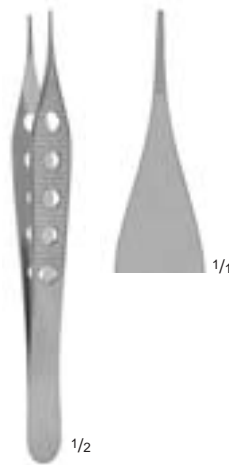

MICRO-ADSON
22-0912
12 cm, 4^{3/4}"

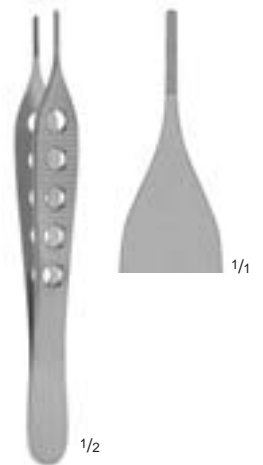

ADSON
09-0377
12 cm, 4^{3/4}"



Feine anatomische Pinzetten
 Delicate Dissecting Forceps
 Pinzas finas de disección
 Pincas fines pour dissection
 Pinze anatomiche per dissezione, fini



09-0040
12,5 cm, 5"



1/1

▶ 09-0042
15 cm, 6"



1/1

1/2

SEMKEN
09-0040
- 09-0042



1/2

MC INDOE
09-0438
15 cm, 6"



1/1



1/2

GERALD
09-0610
- 09-0611



1/1

▶ 09-0610
17,5 cm, 7"



1/1

09-0611
17,5 cm, 7"



1/2

CUSHING
09-0740
- 09-0742



1/1

▶ 09-0740
17,5 cm, 7"



1/1

09-0742
17,5 cm, 7"

mit Dissektor-Ende
with dissector end
con cabo disecador
avec talon dissecteur
con dissettore



mit Dissektor-Ende
 with dissector end
 con cabo dissecador
 avec talon dissecteur
 con dissettore

TAYLOR-CUSHING
 09-0700
 17,5 cm, 7"



▶ 09-0560
 18,5 cm, 7 1/4"

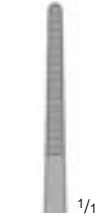

09-0565
 21 cm, 8 1/4"



09-0570
 24,5 cm, 9 3/4"

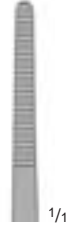

09-0572
 30,5 cm, 12"

POTTS-SMITH
 09-0560
 - 09-0572



BROPHY
 09-0284
 - 09-0285



▶ 09-0284
 19,5 cm, 7 3/4"



09-0285
 19,5 cm, 7 3/4"



WAUGH
 09-0422
 20 cm, 8"



09-0239
 20 cm, 8"





Anatomische Pinzetten
 Dissecting Forceps
 Pinzas de disección
 Pincès à dissection
 Pinze anatomiche per dissezione

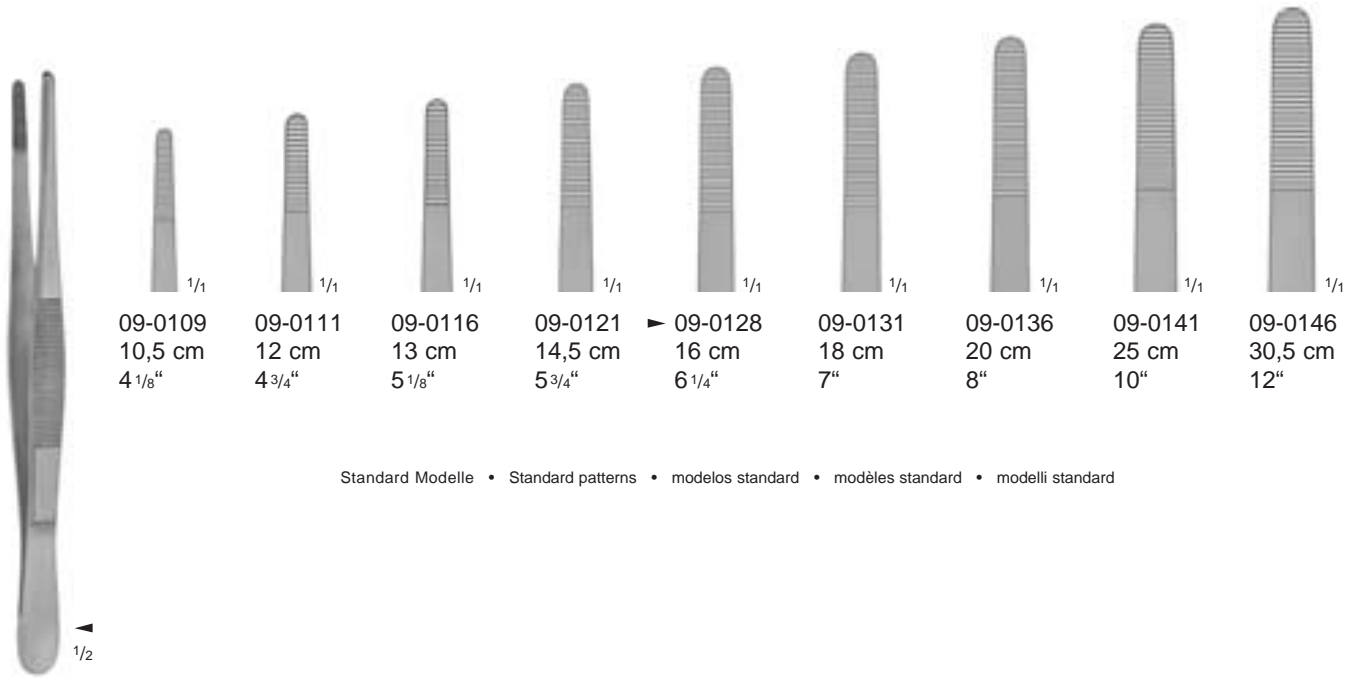

Standard Modelle • Standard patterns • modelos standard • modèles standard • modelli standard

09-0109
 - 09-0146

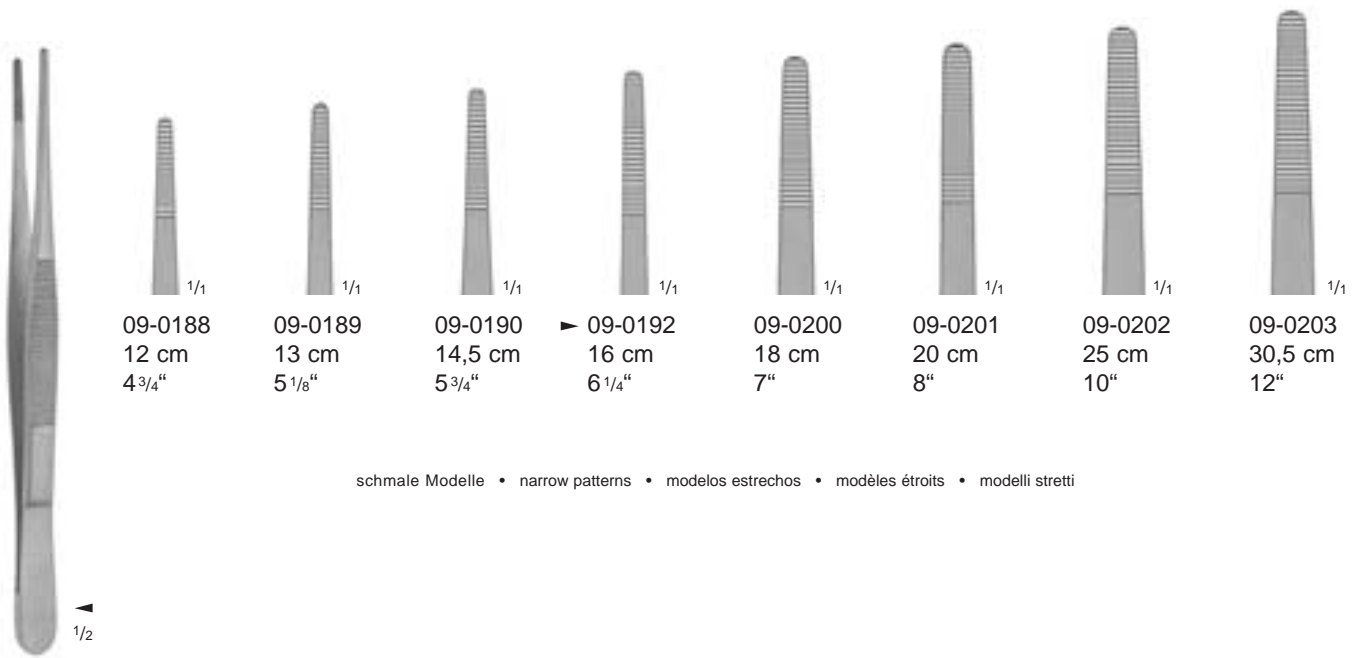

schmale Modelle • narrow patterns • modelos estrechos • modèles étroits • modelli stretti

09-0188
 - 09-0203

Anatomische Pinzetten
 Dissecting Forceps
 Pinzas de disección
 Pincès à dissection
 Pinze anatomiche per dissezione

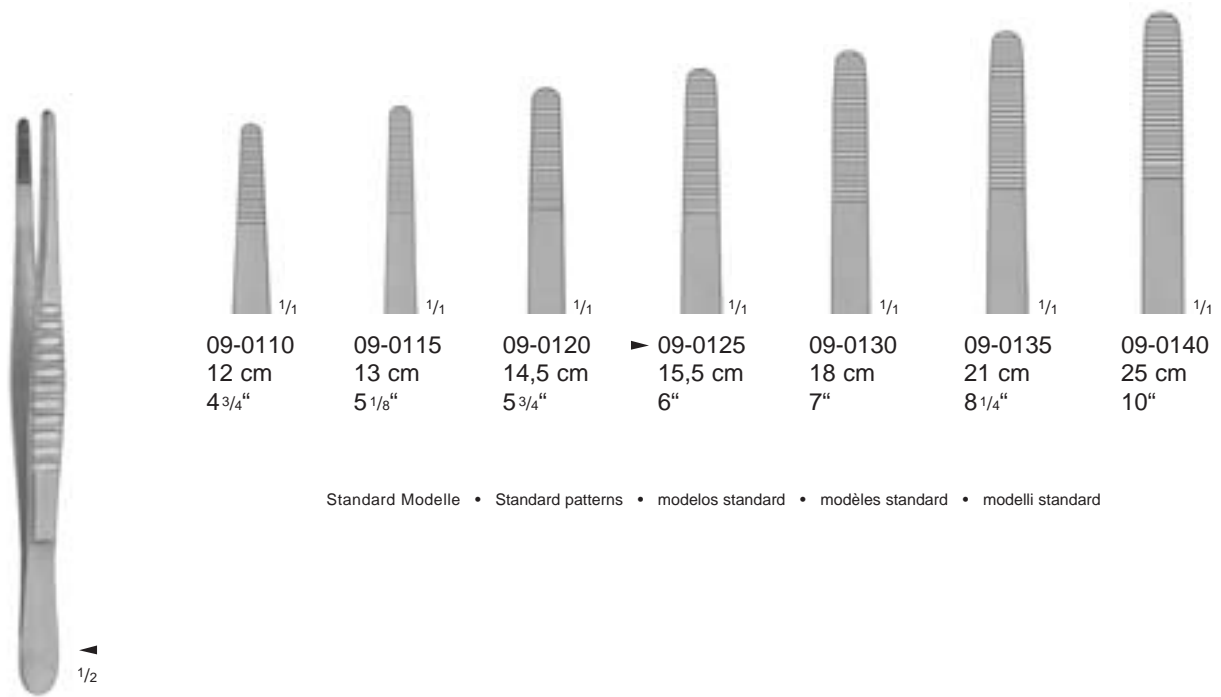

| | | | | | | |
|---------|---------|---------|-----------|---------|---------|---------|
| 09-0110 | 09-0115 | 09-0120 | ▶ 09-0125 | 09-0130 | 09-0135 | 09-0140 |
| 12 cm | 13 cm | 14,5 cm | 15,5 cm | 18 cm | 21 cm | 25 cm |
| 4 3/4" | 5 1/8" | 5 3/4" | 6" | 7" | 8 1/4" | 10" |

Standard Modelle • Standard patterns • modelos standard • modèles standard • modelli standard

MOD. USA
 09-0110
 - 09-0140

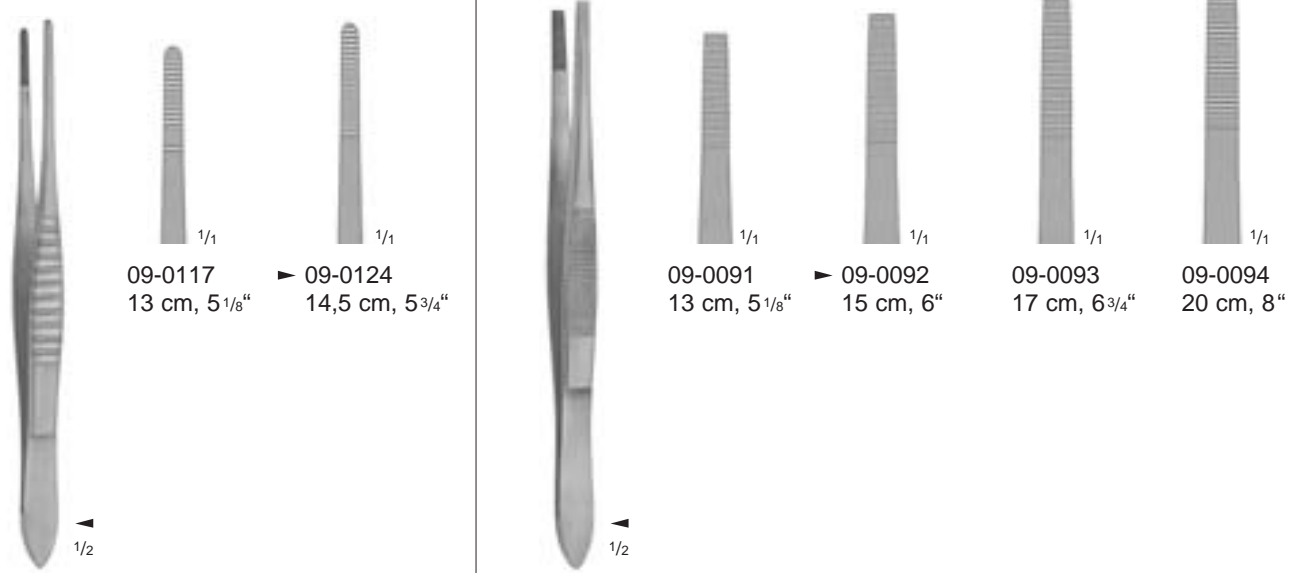

| | | | | | |
|---------------|-----------------|---------------|-----------|---------------|-----------|
| 09-0117 | ▶ 09-0124 | 09-0091 | ▶ 09-0092 | 09-0093 | 09-0094 |
| 13 cm, 5 1/8" | 14,5 cm, 5 3/4" | 13 cm, 5 1/8" | 15 cm, 6" | 17 cm, 6 3/4" | 20 cm, 8" |

MOD. USA
 09-0117
 - 09-0124

09-0091
 - 09-0094

schmale Modelle
 narrow patterns
 modelos estrechos
 modèles étroits
 modelli stretti

schwedische Modelle
 Swedish patterns
 modelos suecos
 modèles suédois
 modelli svedese



Anatomische Pinzetten
 Dissecting Forceps
 Pinzas de disección
 Pinces à dissection
 Pinze anatomiche per dissezione

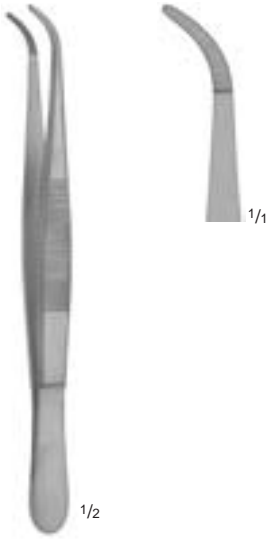

09-0191
 14 cm, 5 1/2"

schmales Modell
 narrow pattern
 modelo estrecho
 modèle étroits
 modello stretto

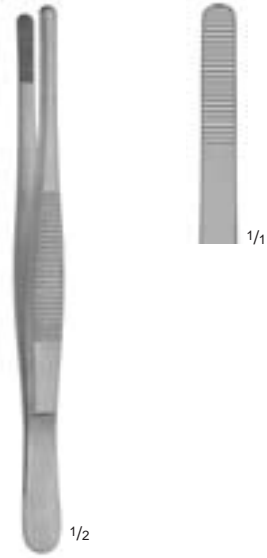

09-0123
 14,5 cm, 5 3/4"

breites Modell
 wide pattern
 modelo ancho
 modèle large
 modello largo

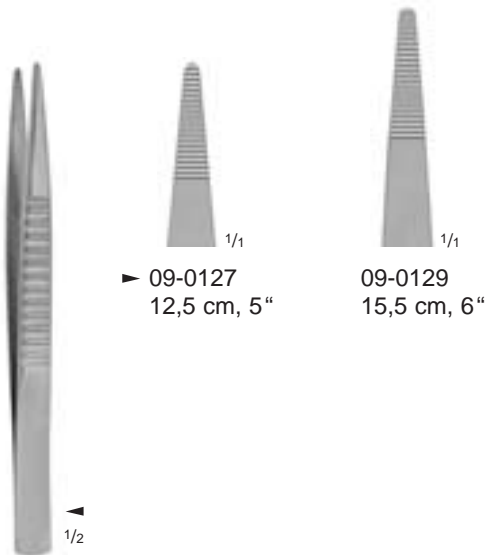

▶ 09-0127
 12,5 cm, 5"

09-0129
 15,5 cm, 6"

09-0127
 - 09-0129

englische Modelle
 English patterns
 modelos ingleses
 modèles anglais
 modelli inglese

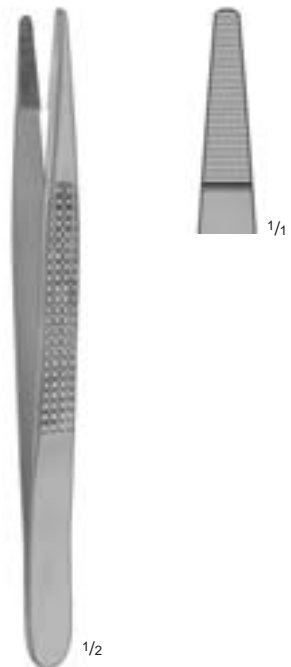

BONNEY
 09-0280
 17 cm, 6 3/4"

ATRAUMATIC-GRIP Gefäßpinzetten mit atraumatischer Riefung
ATRAUMATIC-GRIP Vascular Forceps with non-traumatic serration
ATRAUMATIC-GRIP Pinzas vasculares con bocas atraumáticas
ATRAUMATIC-GRIP Pincers vasculaires avec mors atraumatiques
ATRAUMATIC-GRIP Pinze vascolari con presa atraumatica



1,5 mm

1,5 mm

1,5 mm



1/1

30-0051
15,5 cm, 6"



1/1

30-0061
20 cm, 8"



1/1

30-0071
24 cm, 9 1/2"

2,0 mm

2,0 mm

2,0 mm

2,0 mm



1/1

30-0050
15,5 cm, 6"



1/1

▶ 30-0060
20 cm, 8"



1/1

30-0070
24 cm, 9 1/2"



1/1

30-0010
30,5 cm, 12"



2,0 mm

2,0 mm

2,0 mm

2,7 mm



1/1

30-0055
15 cm, 6"



1/1

30-0065
19,5 cm, 7 3/4"



1/1

30-0075
23,5 cm, 9 1/4"



1/1

30-0024
30 cm, 12"



1/2

DE BAKEY
 30-0010
 - 30-0075

2,7 mm

2,7 mm

2,7 mm

2,7 mm



1/1

30-0020
15,5 cm, 6"



1/1

30-0021
20 cm, 8"



1/1

30-0022
24 cm, 9 1/2"



1/1

30-0023
30,5 cm, 12"

3,5 mm

3,5 mm

3,5 mm

3,5 mm



1/1

30-0030
15,5 cm, 6"



1/1

30-0031
20 cm, 8"



1/1

30-0032
24 cm, 9 1/2"



1/1

30-0033
30,5 cm, 12"



Ohr- und Nasenpinzetten, bajonettförmig
 Ear and Nasal Dressing Forceps, bayonet-shaped
 Pinzas auriculares y nasales, en forma bayoneta
 Pinces auriculaires et nasales, en forme de baïonnette
 Pinze auricolari e nasali, a baionetta



LUCAE
 09-0812
 14 cm, 5 1/2"



JANSEN
 09-0814
 16 cm, 6 1/4"



GRUENWALD (JANSEN)
 09-0818
 19 cm, 7 1/2"



TAYLOR-CUSHING
 09-0710
 18,5 cm, 7 1/4"

mit Dissektor-Ende
 with dissector end
 con cabo disecador
 avec talon dissecteur
 con dissettore



GRUENWALD
 09-0815
 16 cm, 6 1/4"
 1x2 Zähne
 1x2 teeth
 1x2 dientes
 1x2 dents
 1x2 denti



GRUENWALD
 09-0819
 19 cm, 7 1/2"
 1x2 Zähne
 1x2 teeth
 1x2 dientes
 1x2 dents
 1x2 denti



TAYLOR-CUSHING
 09-0715
 18,5 cm, 7 1/4"
 1x2 Zähne
 1x2 teeth
 1x2 dientes
 1x2 dents
 1x2 denti

mit Dissektor-Ende
 with dissector end
 con cabo disecador
 avec talon dissecteur
 con dissettore

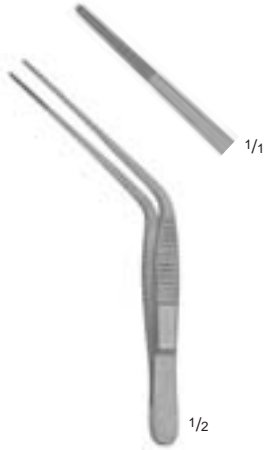

TROELTSCH (WILDE)
 09-0804
 11 cm, 4^{3/8}"



TROELTSCH (WILDE)
 09-0800
 12,5 cm, 5"



TROELTSCH (WILDE)
 09-0806
 13,5 cm, 5^{1/4}"
 selbstschließend
 cross action
 cruzada
 à pression continue
 incrociata



TROELTSCH
 09-0808
 15 cm, 6"

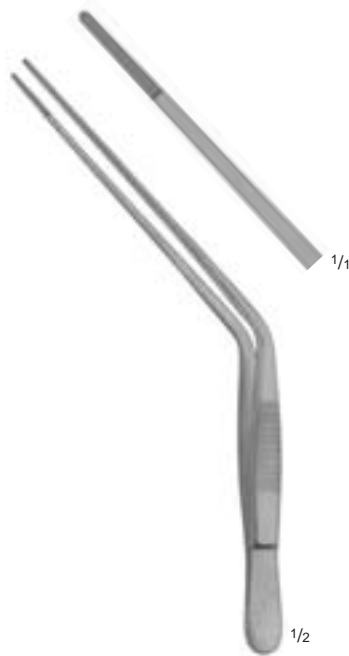

TROELTSCH
 09-0809
 17 cm, 6^{3/4}"



TROELTSCH (WILDE)
 09-0801
 12,5 cm, 5"
 1x2 Zähne
 1x2 teeth
 1x2 dientes
 1x2 dents
 1x2 denti



Feine chirurgische Pinzetten
 Delicate Tissue Forceps
 Pinzas finas quirúrgicas
 Pincas fines quirúrgicas
 Pinze fini per chirurgia

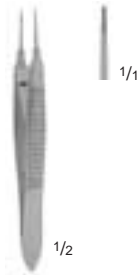

MOD. BONN
62-0255

7 cm, 2 3/4"

mit Fadenplatte
 Zähne 0,12 mm
 with tying platform
 teeth 0.12 mm

con piattaforma
 dientes 0,12 mm

avec méplat
 dents 0,12 mm

con piattaforma
 denti 0,12 mm

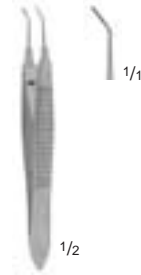

MOD. BONN
62-0254

7 cm, 2 3/4"

mit Fadenplatte
 Zähne 0,12 mm
 with tying platform
 teeth 0.12 mm

con piattaforma
 dientes 0,12 mm

avec méplat
 dents 0,12 mm

con piattaforma
 denti 0,12 mm

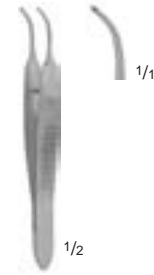

SAUER
62-0561

7 cm, 2 3/4"

ohne Fadenplatte
 Zähne 0,3 mm

without tying platform
 teeth 0.3 mm

sin piattaforma
 dientes 0,3 mm

sans méplat
 dents 0,3 mm

senza piattaforma
 denti 0,3 mm



MOD. BONN
62-0256

9,5 cm, 3 3/4"

mit Fadenplatte
 Zähne 0,12 mm
 with tying platform
 teeth 0.12 mm

con piattaforma
 dientes 0,12 mm

avec méplat
 dents 0,12 mm

con piattaforma
 denti 0,12 mm



CASTROVIEJO

62-0770

- **62-0772**

mit Fadenplatte
 with tying platform
 con piattaforma
 avec méplat
 con piattaforma



62-0772
 10 cm, 4"

Zähne 0,5 mm
 teeth 0.5 mm
 dientes 0.5 mm
 dents 0.5 mm
 denti 0.5 mm



▶ **62-0771**
 10 cm, 4"

Zähne 0,9 mm
 teeth 0.9 mm
 dientes 0.9 mm
 dents 0.9 mm
 denti 0.9 mm



62-0770
 10 cm, 4"

Zähne 1,5 mm
 teeth 1.5 mm
 dientes 1.5 mm
 dents 1.5 mm
 denti 1.5 mm



CASTROVIEJO

62-0749

- **62-0751**

mit Fadenplatte
 with tying platform
 con piattaforma
 avec méplat
 con piattaforma



62-0749
 11 cm, 4 3/8"

Zähne 0,15 mm
 teeth 0.15 mm
 dientes 0.15 mm
 dents 0.15 mm
 denti 0.15 mm



▶ **62-0750**
 11 cm, 4 3/8"

Zähne 0,3 mm
 teeth 0.3 mm
 dientes 0.3 mm
 dents 0.3 mm
 denti 0.3 mm



62-0751
 11 cm, 4 3/8"

Zähne 0,5 mm
 teeth 0.5 mm
 dientes 0.5 mm
 dents 0.5 mm
 denti 0.5 mm



ST. MARTIN
 62-0864
 8 cm, 3 1/8"
 mit Fadenplatte
 with tying platform
 con plataforma
 avec méplat
 con piattaforma



PAUFIQUE
 62-0862
 8,5 cm, 3 3/8"
 mit Fadenplatte
 with tying platform
 con plataforma
 avec méplat
 con piattaforma

0,5 mm



62-0250
 7 cm, 2 3/4"

0,7 mm



▶ 62-0280
 7 cm, 2 3/4"

1,0 mm



62-0281
 7 cm, 2 3/4"

0,5 mm



62-0252
 7 cm, 2 3/4"

0,7 mm



62-0283
 7 cm, 2 3/4"

1,0 mm



62-0284
 7 cm, 2 3/4"

0,5 mm



▶ 09-0026
 10 cm, 4"

1,0 mm



09-0020
 10 cm, 4"

0,5 mm



09-0027
 10 cm, 4"

1,0 mm



09-0021
 10 cm, 4"

0,5 mm



09-0029
 9,5 cm, 3 3/4"

1,0 mm



09-0023
 9,5 cm, 3 3/4"

1/2

GRAEFE
 62-0250
 - 62-0284
 1x2 Zähne
 1x2 teeth
 1x2 dientes
 1x2 dents
 1x2 denti

1/2

09-0020
 - 09-0029
 1x2 Zähne
 1x2 teeth
 1x2 dientes
 1x2 dents
 1x2 denti



Feine chirurgische Pinzetten
Delicate Tissue Forceps
Pinzas finas quirúrgicas
Pincas fines quirúrgicas
Pinze fini per chirurgia

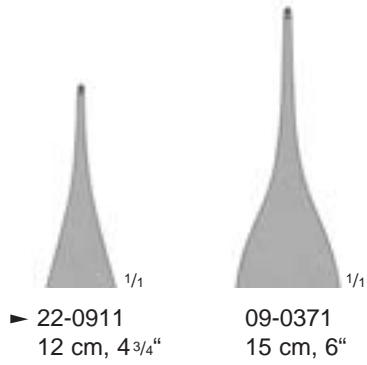

▶ 22-0911
12 cm, 4³/₄"

09-0371
15 cm, 6"

MICRO-ADSON

09-0371
- 22-0911

1x2 Zähne
1x2 teeth
1x2 dientes
1x2 dents
1x2 denti

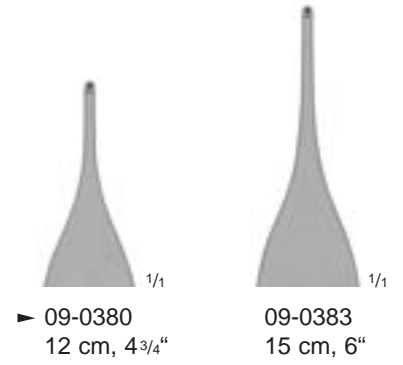

▶ 09-0380
12 cm, 4³/₄"

09-0383
15 cm, 6"

ADSON

09-0380
- 09-0383

1x2 Zähne
1x2 teeth
1x2 dientes
1x2 dents
1x2 denti



EWALD
09-0396
12 cm, 4³/₄"

1x2 Zähne
1x2 teeth
1x2 dientes
1x2 dents
1x2 denti



ADSON
09-0385
12 cm, 4³/₄"

2x3 Zähne
2x3 teeth
2x3 dientes
2x3 dents
2x3 denti

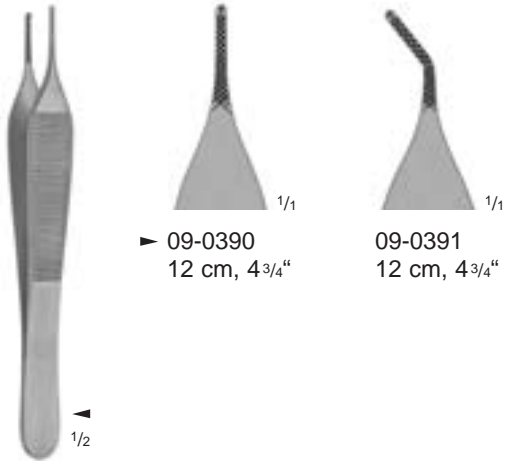

► 09-0390
 12 cm, 4³/₄"

09-0391
 12 cm, 4³/₄"

ADSON
 09-0390
 - 09-0391
 1x2 Zähne
 1x2 teeth
 1x2 dientes
 1x2 dents
 1x2 denti



ADSON-BROWN
 09-0400
 12 cm, 4³/₄"
 9x9 Zähne
 9x9 teeth
 9x9 dientes
 9x9 dents
 9x9 denti

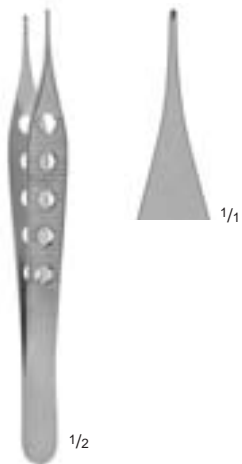

MICRO-ADSON
 09-0397
 12 cm, 4³/₄"
 1x2 Zähne
 1x2 teeth
 1x2 dientes
 1x2 dents
 1x2 denti

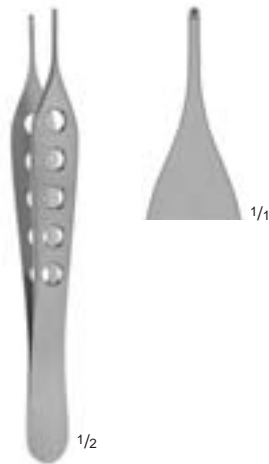

ADSON
 09-0398
 12 cm, 4³/₄"
 1x2 Zähne
 1x2 teeth
 1x2 dientes
 1x2 dents
 1x2 denti

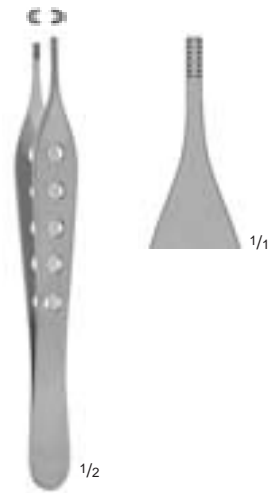

ADSON-BROWN
 09-0399
 12 cm, 4³/₄"
 9x9 Zähne
 9x9 teeth
 9x9 dientes
 9x9 dents
 9x9 denti



Feine chirurgische Pinzetten

Delicate Tissue Forceps

Pinzas finas quirúrgicas

Pinces fines chirurgicales

Pinze fini per chirurgia



▶ **09-0044**
12,5 cm, 5"



1/1



1/1

09-0046
15 cm, 6"

1/2

SEMKEN

09-0044

- **09-0046**

1x2 Zähne
1x2 teeth
1x2 dientes
1x2 dents
1x2 denti



1/1

1/2

GILLIES

09-0425

15 cm, 6"

1x2 Zähne
1x2 teeth
1x2 dientes
1x2 dents
1x2 denti



▶ **09-0616**
17,5 cm, 7"



1/1



1/1

09-0617
17,5 cm, 7"

1/2

GERALD

09-0616

- **09-0617**

1x2 Zähne
1x2 teeth
1x2 dientes
1x2 dents
1x2 denti

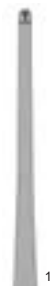

1/1

1/2

mit Dissektor-Ende
with dissector end
con cabo disecador
avec talon dissecteur
con dissettore

CUSHING

09-0745

17,5 cm, 7"

1x2 Zähne
1x2 teeth
1x2 dientes
1x2 dents
1x2 denti

Feine chirurgische Pinzetten

Delicate Tissue Forceps

Pinzas finas quirúrgicas

Pinces fines chirurgicales

Pinze fini per chirurgia



1x2 Zähne, mit Dissektor-Ende

1x2 teeth, with dissector end

1x2 dientes, con cabo disecador

1x2 dents, avec talon dissecteur

1x2 denti, con dissettore

TAYLOR-CUSHING
09-0705
17,5 cm, 7"



POTTS-SMITH
09-0575
- 09-0587

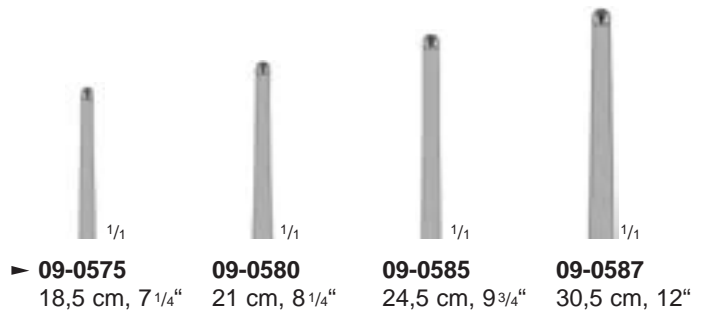

1x2 Zähne • 1x2 teeth • 1x2 dientes • 1x2 dents • 1x2 denti



BROPHY
09-0286
- 09-0287

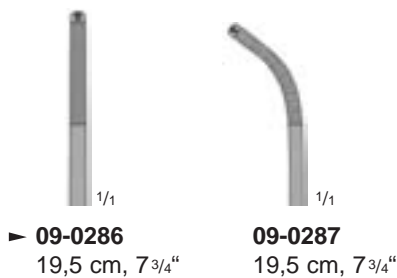

1x2 Zähne
1x2 teeth
1x2 dientes
1x2 dents
1x2 denti



WAUGH
09-0423
20,5 cm, 8"

1x2 Zähne
1x2 teeth
1x2 dientes
1x2 dents
1x2 denti



Chirurgische Pinzetten









Tissue Forceps

Pinzas quirúrgicas

Pinces chirurgicales

Pinze per chirurgia



| | | | | | | | | |
|---|---|---|---|---|---|---|---|---|
|  1/1 |  1/1 |  1/1 |  1/1 |  1/1 |  1/1 |  1/1 |  1/1 |  1/1 |
| 09-0149 10,5 cm 4 1/8" | 09-0151 12 cm 4 3/4" | 09-0156 ▶ 13 cm 5 1/8" | 09-0161 14,5 cm 5 3/4" | 09-0168 16 cm 6 1/4" | 09-0171 18 cm 7" | 09-0176 20,5 cm 8" | 09-0181 25 cm 10" | 09-0186 30,5 cm 12" |

09-0149
- **09-0186**

Standard Modelle, 1x2 Zähne







Standard patterns, 1x2 teeth

modelos standard, 1x2 dientes

modèles standard, 1x2 dents

modelli standard, 1x2 denti



| | | | | | |
|---|---|---|---|---|---|
|  1/1 |  1/1 |  1/1 |  1/1 |  1/1 |  1/1 |
| 09-0198 12 cm 4 3/4" | 09-0193 13 cm 5 1/8" | ▶ 09-0195 14,5 cm 5 3/4" | 09-0196 16 cm 6 1/4" | 09-0204 18 cm 7" | 09-0205 20,5 cm 8" |

09-0193
- **09-0205**

schmale Modelle, 1x2 Zähne

narrow patterns, 1x2 teeth

modelos estrechos, 1x2 dientes

modèles étroits, 1x2 dents

modelli stretti, 1x2 denti

Chirurgische Pinzetten

Tissue Forceps

Pinzas quirúrgicas

Pinces chirurgicales

Pinze per chirurgia



1/2



1/1

09-0150

12 cm

4 3/4"



1/1

09-0155

13 cm

5 1/8"



1/1

09-0160

14,5 cm

5 3/4"



1/1

► **09-0165**

15,5 cm

6"



1/1

09-0170

18 cm

7"



1/1

09-0175

20,5 cm

8"



1/1

09-0180

25 cm

10"

MOD. USA

09-0150

- **09-0180**

Standard Modelle, 1x2 Zähne

Standard patterns, 1x2 teeth

modelos standard, 1x2 dientes

modèles standard, 1x2 dents

modelli standard, 1x2 denti



1/2



1/1

MOD. USA

09-0194

14,5 cm, 5 3/4"

schmales Modell, 1x2 Zähne

narrow pattern, 1x2 teeth

modelo estrecho, 1x2 dientes

modèle étroit, 1x2 dents

modello stretto, 1x2 denti



1/2



1/1

09-0197

14 cm, 5 1/2"

schmales Modell, 1x2 Zähne

narrow pattern, 1x2 teeth

modelo estrecho, 1x2 dientes

modèle étroit, 1x2 dents

modello stretto, 1x2 denti



Chirurgische Pinzetten

Tissue Forceps

Pinzas quirúrgicas

Pinces chirurgicales

Pinze per chirurgia



1/2



1/1

09-0216

13 cm, 5 1/8"



1/1

► **09-0221**

14,5 cm, 5 3/4"



1/1

09-0226

16 cm, 6 1/4"



1/1

09-0231

18 cm, 7"



1/1

09-0236

20 cm, 8"



1/1

09-0241

25 cm, 10"

09-0216

- **09-0241**

2x3 Zähne
2x3 teeth
2x3 dientes
2x3 dents
2x3 denti



1/2



1/1

► **09-0261**

14,5 cm, 5 3/4"



1/1

09-0266

16 cm, 6 1/4"



1/1

09-0276

20 cm, 8"

09-0261

- **09-0276**

3x4 Zähne
3x4 teeth
3x4 dientes
3x4 dents
3x4 denti



1/2



1/1

09-0277

14,5 cm 5 3/4"

4x5 Zähne
4x5 teeth
4x5 dientes
4x5 dents
4x5 denti

Chirurgische Pinzetten

Tissue Forceps

Pinzas quirúrgicas

Pinces chirurgicales

Pinze per chirurgia



HEANEY
09-0495
13,5 cm, 5 1/4"

2x3 Zähne
2x3 teeth
2x3 dientes
2x3 dents
2x3 denti

1/2



HEANEY
09-0496
19 cm, 7 1/2"

1x2 Zähne
1x2 teeth
1x2 dientes
1x2 dents
1x2 denti

1/2



HEANEY
09-0497
19 cm, 7 1/2"

3x4 Zähne
3x4 teeth
3x4 dientes
3x4 dents
3x4 denti

1/2



CURTIS
09-0499
22,5 cm, 9"

1x2 Zähne
1x2 teeth
1x2 dientes
1x2 dents
1x2 denti

1/2

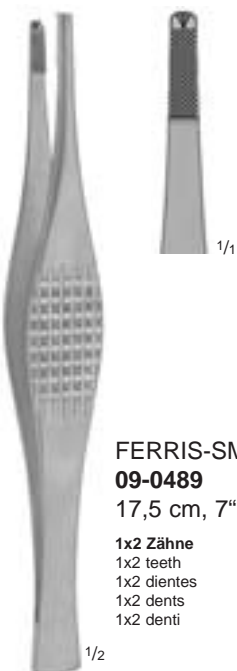

FERRIS-SMITH
09-0489
17,5 cm, 7"

1x2 Zähne
1x2 teeth
1x2 dientes
1x2 dents
1x2 denti

1/2

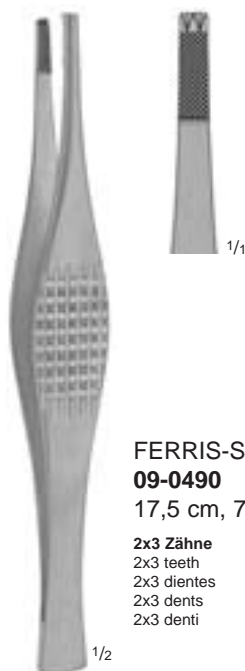

FERRIS-SMITH
09-0490
17,5 cm, 7"

2x3 Zähne
2x3 teeth
2x3 dientes
2x3 dents
2x3 denti

1/2

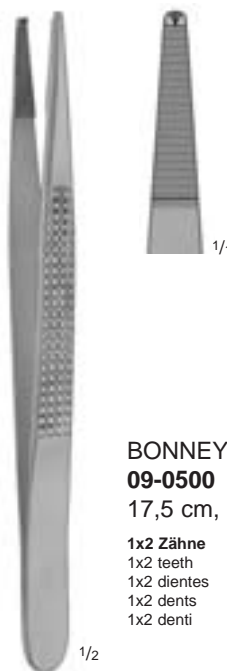

BONNEY
09-0500
17,5 cm, 7"

1x2 Zähne
1x2 teeth
1x2 dientes
1x2 dents
1x2 denti

1/2

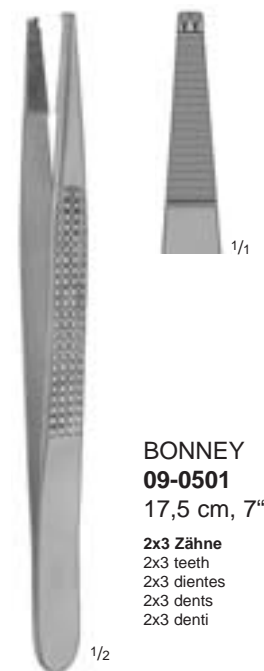

BONNEY
09-0501
17,5 cm, 7"

2x3 Zähne
2x3 teeth
2x3 dientes
2x3 dents
2x3 denti

1/2



Chirurgische Pinzetten

Tissue Forceps

Pinzas quirúrgicas

Pinces chirurgicales

Pinze per chirurgia



1/2

► **09-0410**
15 cm, 6"

09-0415
20,5 cm, 8"

09-0420
25 cm, 10"

BROWN
09-0410
- **09-0420**

Gewebefußpinzetten
Tissue seizing forceps
Pinzas agarre de tejidos
Pinces pour saisir les tissus
Pinze da presa per tessuti



1/1



1/1



1/1



1/2

GRAEFE
09-0351
11 cm, 4 3/8"

5x6 Zähne
5x6 teeth
5x6 dientes
5x6 dents
5x6 denti



1/1



1/2

NELSON
09-0660
23 cm, 9"

6x7 Zähne
6x7 teeth
6x7 dientes
6x7 dents
6x7 denti



1/1



1/2

► **09-0520**
14,5 cm 5 3/4"

4x5 Zähne
4x5 teeth
4x5 dientes
4x5 dents
4x5 denti

09-0525
20,5 cm 8"

4x5 Zähne
4x5 teeth
4x5 dientes
4x5 dents
4x5 denti

09-0530
24,5 cm 9 3/4"

6x7 Zähne
6x7 teeth
6x7 dientes
6x7 dents
6x7 denti

ADLERKREUTZ
09-0520
- **09-0530**

Gefäß- und Tumorpinzetten
Vascular and tumor forceps
Pinzas para vasos y tumores
Pinces pour vaisseaux et tumeurs
Pinza vascolare e per tumori



1/1



1/1



1/1



1/2

► **09-0531**
18 cm, 7"

3x4 Zähne
3x4 teeth
3x4 dientes
3x4 dents
3x4 denti

09-0532
20 cm, 8"

3x4 Zähne
3x4 teeth
3x4 dientes
3x4 dents
3x4 denti

09-0533
24,5 cm, 9 3/4"

3x4 Zähne
3x4 teeth
3x4 dientes
3x4 dents
3x4 denti

STILLE-BARRAYA
09-0531
- **09-0533**

Gefäß- und Tumorpinzetten
Vascular and tumor forceps
Pinzas para vasos y tumores
Pinces pour vaisseaux et tumeurs
Pinza vascolare e per tumori



1/1



1/1



1/1

Faßpinzetten

Grasping Forceps

Pinzas de agarre

Pinces pour saisir les tissus

Pinze per afferrare tessuti

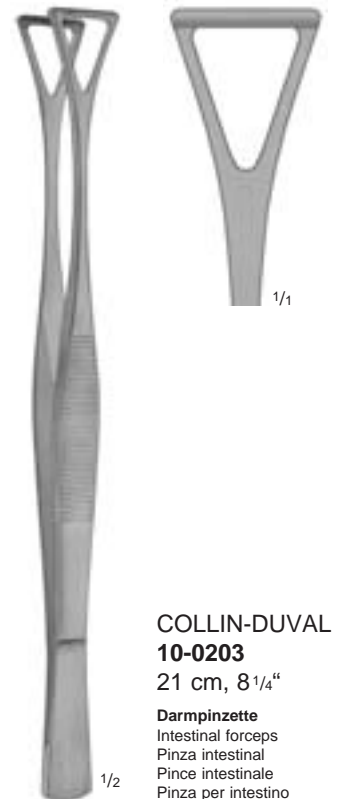
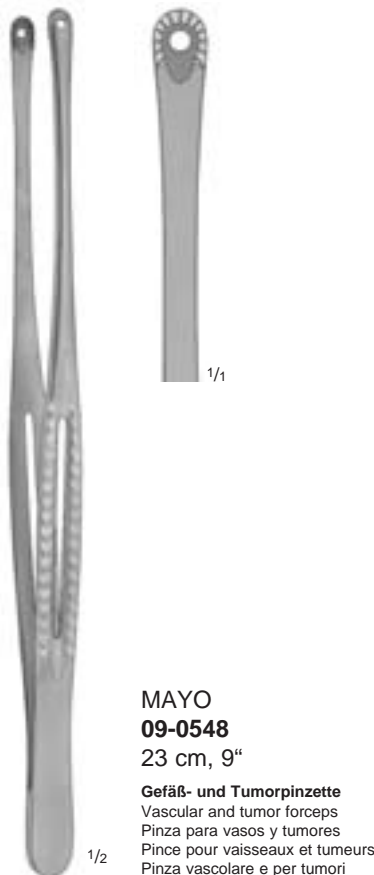
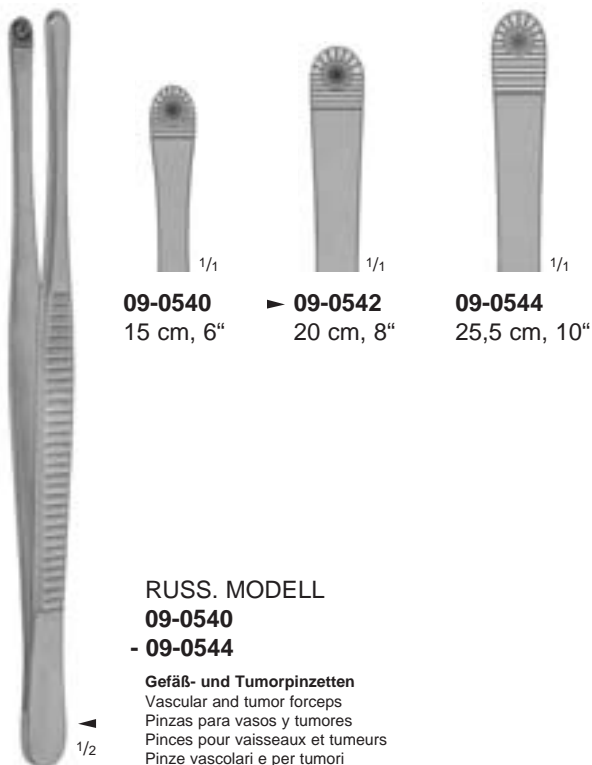
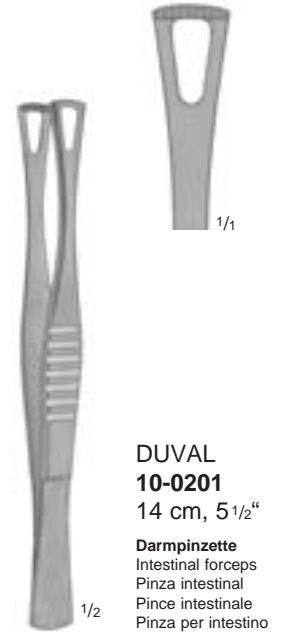
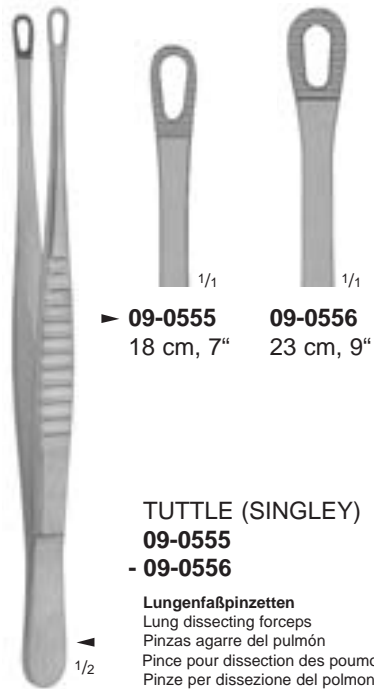
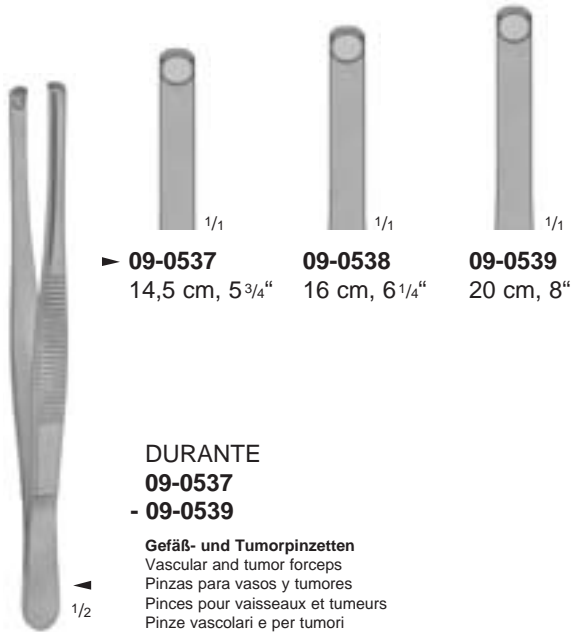



Splitterpinzetten

Splinter Forceps
Pinzas para espinas
Pinces à échardes
Pinze per schegge



► **09-0920**
8,5 cm, 3³/₈"



09-0922
10 cm, 4"



09-0924
12,5 cm, 5"



09-0926
14 cm, 5¹/₂"



09-0921
8,5 cm, 3³/₈"



09-0923
10 cm, 4"



09-0925
12,5 cm, 5"



09-0927
14 cm, 5¹/₂"



09-0920
- **09-0927**



HUNTER
09-0940
- **09-0941**



► **09-0940**
10,5 cm, 4¹/₈"



09-0941
10,5 cm, 4¹/₈"



FEILCHENFELD
09-0830
- **09-0931**



09-0830
8 cm, 3¹/₈"



09-0832
9 cm, 3¹/₂"



► **09-0931**
11,5 cm, 4¹/₂"



FEILCHENFELD
09-0933
13 cm, 5¹/₈"

mit Lupe
with magnifying loupe
con lente de aumento
avec loupe
con lente di ingrandimento

Splitterzangen

Splinter Forceps

Pinzas para espinas

Pinces à échardes

Pinze per schegge

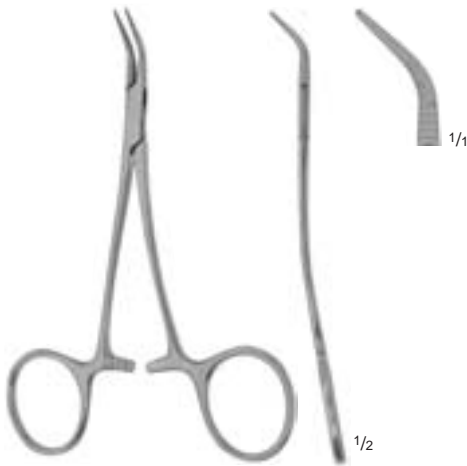

PEET
06-0110
12 cm, 4³/₄"



PEET
09-1880
- **09-1881**

mit Hartmetalleinlagen
with tungsten carbide inserts
con bocas de carburo tungsteno
avec mors en carbure de tungstène
con inserti in carburo di tungsteno

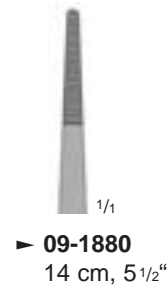

► **09-1880**
14 cm, 5¹/₂"



09-1881
14 cm, 5¹/₂"



RALKS
(VIRTUS)
09-0980
14,5 cm, 5³/₄"



ARTHUR
09-0988
14 cm, 5¹/₂"

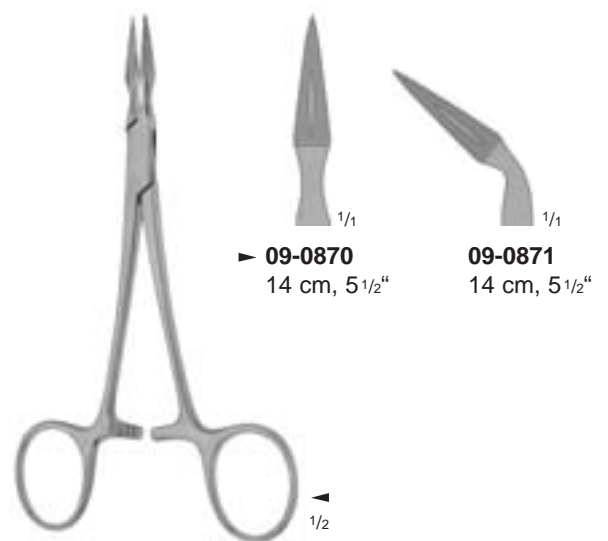

STIEGLITZ
(WILLIAMS)
09-0870
- **09-0871**

► **09-0870**
14 cm, 5¹/₂"

09-0871
14 cm, 5¹/₂"



Cilienpinzetten

Cilia Forceps
Pinzas depilatorias
Pincès à épiler
Pinze per ciglia

Deckglaspinzette

Cover Glass Forceps
Pinza porta-laminillas
Pince porte-laminaires
Pinza con copertura vetrificata

Fadenpinzette

Ligature Forceps
Pinza para ligaduras
Pince pour ligatures
Pinza per legature



SCHAAF
62-1220
9,5 cm, 3 3/4"

Cilienpinzette
Cilia forceps
Pinza depilatoria
Pince à épiler
Pinza per ciglia

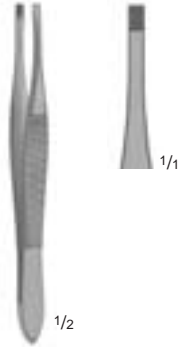

DOUGLAS
62-1400
9 cm, 3 1/2"

Cilienpinzette
Cilia forceps
Pinza depilatoria
Pince à épiler
Pinza per ciglia

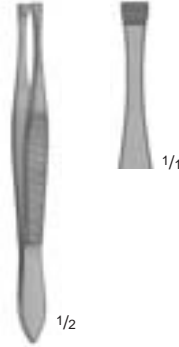

LITTAUER
62-1405
9 cm, 3 1/2"

Cilienpinzette
Cilia forceps
Pinza depilatoria
Pince à épiler
Pinza per ciglia

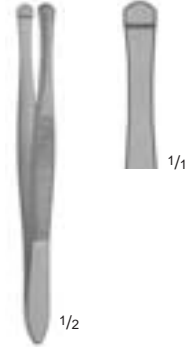

BEER
62-1420
9 cm, 3 1/2"

Cilienpinzette
Cilia forceps
Pinza depilatoria
Pince à épiler
Pinza per ciglia

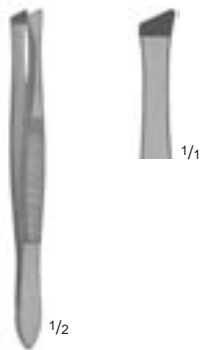

62-1402
9 cm, 3 1/2"

Cilienpinzette
Cilia forceps
Pinza depilatoria
Pince à épiler
Pinza per ciglia

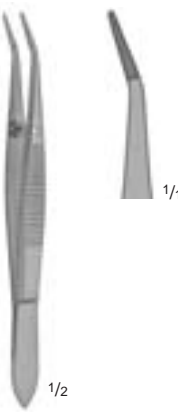

BARRAQUER
62-1460
10,5 cm, 4 1/8"

Cilienpinzette
Cilia forceps
Pinza depilatoria
Pince à épiler
Pinza per ciglia

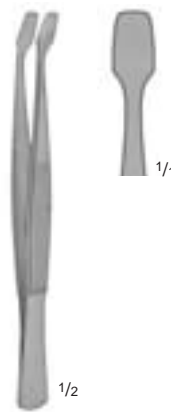

KÜHNE
09-0990
10,5 cm, 4 1/8"

Deckglaspinzette
Cover glass forceps
Pinza porta-laminilla
Pince porte-laminaires
Pinza con copertura vetrificata

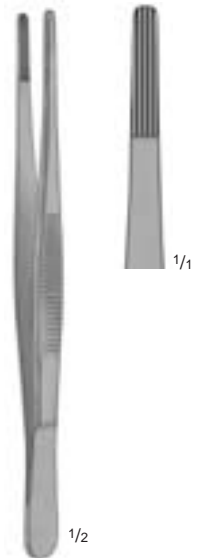

OCHSNER
09-0994
14,5 cm, 5 3/4"

Fadenpinzette
Ligature forceps
Pinza para ligadura
Pince pour ligatures
Pinza per legature



LAWNTON

Medizintechnik



Klemmen, Klemmzangen
Forceps, Clamps Forceps
Pinzas, Pinzas-clamps
Pinces, Pinces-clamps
Pinze, Pinze emostatiche



Gefäßclips für temporären Gebrauch
 Vessel Clips for temporary occlusion
 Clips vasculares para oclusión temporal
 Serre-Fines pour occlusion temporaire
 Pinze per occlusione temporanee



MINI-YASARGIL
 06-0140
 18 cm, 7"



MINI-YASARGIL
 ▶ 06-0141 17 cm, 6³/₄"
 06-0142 21 cm, 8¹/₄"
 06-0143 23 cm, 9"



STANDARD-YASARGIL
 06-0145
 18 cm, 7"



STANDARD-YASARGIL
 ▶ 06-0146 17 cm, 6³/₄"
 06-0147 21 cm, 8¹/₄"
 06-0148 23 cm, 9"

Anlegepinzetten für Gefäßclips 06-0180 - 06-0185
 Applying forceps for vessel clips 06-0180 - 06-0185
 Pinzas para aplicar clips vasculares 06-0180 - 06-0185
 Applicateur pour clips vasculaires 06-0180 - 06-0185
 Applicatore per clips vascolari 06-0180 - 06-0185

Anlegepinzetten für Gefäßclips 06-0190 - 06-0193
 Applying forceps for vessel clips 06-0190 - 06-0193
 Pinzas para aplicar clips vasculares 06-0190 - 06-0193
 Applicateur pour clips vasculaires 06-0190 - 06-0193
 Applicatore per clips vascolari 06-0190 - 06-0193



MINI-YASARGIL
 06-0180
 - 06-0185



STANDARD-YASARGIL
 06-0190
 - 06-0193

| Maul kreuzgerieft Cross serrations Boca estriada crucial Mors à rainures croisées Morsi a zigrinatura incrociata | Kat. Nr. Cat. ref. Núm. de cat. No. de cat. No di cat. | Maul- öffnung Opening of jaw Apertura de boca Ouverture des mors Apertura dei morsi | Maul- länge Length of jaw Longitud de boca Longueur des mors Lungh. dei morsi | Schließ- druck Occlusion pressure Presión de oclusión Pression d'occlusion Pressione occlusiva |
|--|--|--|--|---|
| 1/1 | 06-0180 | 3,3 mm | 3 mm | 50 gr. |
| 1/1 | 06-0181 | 4,0 mm | 5 mm | 50 gr. |
| 1/1 | 06-0182 | 3,8 mm | 5 mm | 50 gr. |
| 1/1 | 06-0183 | 4,6 mm | 7 mm | 70 gr. |
| 1/1 | ▶ 06-0184 | 4,4 mm | 7 mm | 70 gr. |
| 1/1 | 06-0185 | 4,0 mm | 7 mm | 70 gr. |

| Maul kreuzgerieft Cross serrations Boca estriada crucial Mors à rainures croisées Morsi a zigrinatura incrociata | Kat. Nr. Cat. ref. Núm. de cat. No. de cat. No di cat. | Maul- öffnung Opening of jaw Apertura de boca Ouverture des mors Apertura dei morsi | Maul- länge Length of jaw Longitud de boca Longueur des mors Lungh. dei morsi | Schließ- druck Occlusion pressure Presión de oclusión Pression d'occlusion Pressione occlusiva |
|--|--|--|--|---|
| 1/1 | ▶ 06-0190 | 7,0 mm | 9 mm | 70 gr. |
| 1/1 | 06-0191 | 6,8 mm | 9 mm | 70 gr. |
| 1/1 | 06-0192 | 6,1 mm | 9 mm | 70 gr. |
| 1/1 | 06-0193 | 6,5 mm | 9 mm | 70 gr. |

Gefäßclips für temporären Gebrauch
 Vessel Clips for temporary occlusion
 Clips vasculares para oclusión temporal
 Serre-Fines pour occlusion temporaire
 Pinze per occlusioni temporanee



SCHWARTZ
 50-0620
 19,5 cm, 7 3/4"

Anlegezange für Gefäßclips 50-0621 - 50-0623
 Applying forceps for vessel clips 50-0621 - 50-0623
 Pinza para aplicar clips vasculares 50-0621 - 50-0623
 Applicateur pour clips vasculaires 50-0621 - 50-0623
 Applicatore per clips vascolari 50-0621 - 50-0623



SCHWARTZ
 50-0621
 - 50-0623



Maul glatt
 Smooth jaws
 Boca lisa
 Mors lisses
 Morsi lisci

Kat. Nr.
 Cat. ref.
 Núm. de cat.
 No. de cat.
 No di cat.

Maulöffnung
 Opening of jaw
 Apertura de boca
 Ouverture des mors
 Apertura dei morsi

Maullänge
 Length of jaw
 Longitud de boca
 Longueur des mors
 Lungh. dei morsi

Schließdruck
 Occlusion pressure
 Presión de oclusión
 Pression d'occlusion
 Pressione occlusiva

| Maul glatt Smooth jaws Boca lisa Mors lisses Morsi lisci | Kat. Nr. Cat. ref. Núm. de cat. No. de cat. No di cat. | Maulöffnung Opening of jaw Apertura de boca Ouverture des mors Apertura dei morsi | Maullänge Length of jaw Longitud de boca Longueur des mors Lungh. dei morsi | Schließdruck Occlusion pressure Presión de oclusión Pression d'occlusion Pressione occlusiva |
|---|--|---|---|--|
|  1/1 | ▶ 50-0621 | 3 mm | 10 mm | 720 gr. |
|  1/1 | 50-0622 | 3 mm | 10 mm | 720 gr. |
|  1/1 | 50-0623 | 3 mm | 10 mm | 720 gr. |



Gefäßclips für temporären Gebrauch
Vessel Clips for temporary occlusion
Clips vasculares para oclusión temporal
Serre-Fines pour occlusion temporaire
Pinze per occlusioni temporanee



06-0470
 14,5 cm, 5 3/4"

Anlegepinzette ohne Schloß, für Gefäßclips
 06-0475 - 06-0477 und Approximatoren
 06-0480 - 06-0484

Applying forceps without spring catch,
 for vessel clips 06-0475 - 06-0477 and
 approximators 06-0480 - 06-0484

Pinza para aplicar clips vasculares
 06-0475 - 06-0477 y aproximadores
 06-0480 - 06-0484, sin cierre de resorte

Pince pour poser les clips vasculaires
 06-0475 - 06-0477 et approximateurs
 06-0480 - 06-0484 sans fermeture

Applicatore per clips vascolari
 06-0475 - 06-0477 e approssimatori
 06-0480 - 06-0484 senza fermo

1/2



06-0471
 14,5 cm, 5 3/4"

Anlegepinzette mit Schloß, für Gefäßclips
 06-0475 - 06-0477 und Approximatoren
 06-0480 - 06-0484

Applying forceps with spring catch,
 for vessel clips 06-0475 - 06-0477 and
 approximators 06-0480 - 06-0484

Pinza para aplicar clips vasculares
 06-0475 - 06-0477 y aproximadores
 06-0480 - 06-0484, con cierre de resorte

Pince pour poser les clips vasculaires
 06-0475 - 06-0477 et approximateurs
 06-0480 - 06-0484 avec fermeture

Applicatore per clips vascolari
 06-0475 - 06-0477 e approssimatori
 06-0480 - 06-0484 con fermo

1/2



BIEMER
06-0475
 - 06-0477

1/1



Maul schräg gerieft
 Oblique serrations
 Boca estriada al oblicuo
 Mors striés en oblique
 Morsi a zigiratura obliqua

Kat. Nr.
 Cat. ref.
 Núm. de cat.
 No. de cat.
 No di cat.

Maulöffnung
 Opening of jaw
 Apertura de boca
 Ouverture des mors
 Apertura dei morsi

Maullänge
 Length of jaw
 Longitud de boca
 Longueur des mors
 Lungh. dei morsi

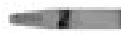
Schließdruck
 Occlusion pressure
 Presión de oclusión
 Pression d'occlusion
 Pressione occlusiva

| | Kat. Nr. Cat. ref. Núm. de cat. No. de cat. No di cat. | Maulöffnung Opening of jaw Apertura de boca Ouverture des mors Apertura dei morsi | Maullänge Length of jaw Longitud de boca Longueur des mors Lungh. dei morsi | Schließdruck Occlusion pressure Presión de oclusión Pression d'occlusion Pressione occlusiva |
|---|--|---|---|--|
|  1/1 | ▶ 06-0475 | 4 mm | 6 mm | 30-40 gr. |
|  1/1 | 06-0476 | 5 mm | 9 mm | 30-40 gr. |
|  1/1 | 06-0477 | 5 mm | 9 mm | 20-25 gr. |

Approximatoren für Mikro-Gefäßanastomosen im oberflächlichen Bereich

Approximators for micro vessel anastomosis in the superficial range

Aproximadores para anastomosis micro-vascular en la superficie

Approximateurs pour anastomose micro vasculaire superficielle

Approssimatori per anastomosi micro-vascolare in superficie



- Der Abstand zwischen den Gefäßclips ist durch einfaches Verschieben variabel und wird durch Verkantung selbsttätig fixiert.
- Adjustable distance between the vessel clips and automatic fixation by tilting.
- Distancia ajustable de los clips vasculares por inclinación y fijación automática.
- La distance entre les clips vasculaires est réglable et fixation automatique par inclination
- Distanza regolabile tra i clips vascolari e posizionamento automatico



BIEMER-MÜLLER

06-0480

1/1 - 06-0484

Maul schräg gerieft
Oblique serrations
Boca estriada al oblicuo
Mors striés en oblique
Morsi a zigrinatura obliqua

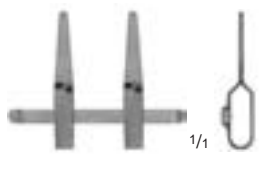
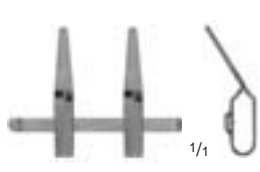
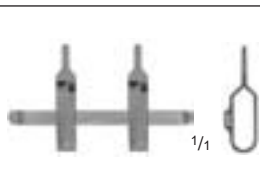
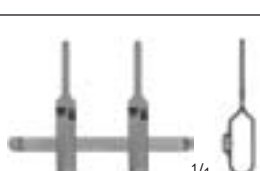
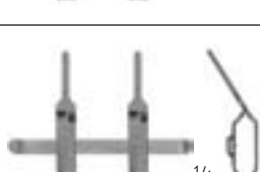
| | Kat. Nr. Cat. ref. Núm. de cat. No. de cat. No di cat. | Maulöffnung Opening of jaw Apertura de boca Ouverture des mors Apertura dei morsi | Maullänge Length of jaw Longitud de boca Longueur des mors Lungh. dei morsi | Schließdruck Occlusion pressure Presión de oclusión Pression d'occlusion Pressione occlusiva |
|---|--|---|---|--|
|  | ▶ 06-0480 | 5 mm | 9 mm | 25-30 gr. |
|  | 06-0481 | 5 mm | 9 mm | 25-30 gr. |
|  | 06-0482 | 3 mm | 4,5 mm | 25-30 gr. |
|  | 06-0483 | 5 mm | 9 mm | 25-30 gr. |
|  | 06-0484 | 5 mm | 9 mm | 25-30 gr. |



Approximatoren mit 3/8 Kreis Maulbogen für feste Rundkörper
Approximators with 3/8 circle jaw parts for rigid round bodies
Approximadores con 3/8 curvatura de boca para cuerpos redondos y rígidos
Approximateurs avec mors 3/8 cercle pour corps ronds rigides
Approssimatori con curvatura della bocca di 3/8 per corpi rotondi e rigidi



06-0470
 14,5 cm, 5 3/4"

Anlegepinzette ohne Schloß, für
 Approximatoren 06-0485 - 06-0488

Applying forceps without spring catch,
 for approximators 06-0485 - 06-0488

Pinza para aplicar aproximadores
 06-0485 - 06-0488, sin cierre de resorte

Pince pour poser les approximateurs
 06-0485 - 06-0488, sans fermeture

Pinza per applicazione approssimatori
 06-0485 - 06-0488, senza fermo

1/2



06-0471
 14,5 cm, 5 3/4"

Anlegepinzette mit Schloß, für
 Approximatoren 06-0485 - 06-0488

Applying forceps with spring catch,
 for approximators 06-0485 - 06-0488

Pinza para aplicar aproximadores
 06-0485 - 06-0488, con cierre de resorte

Pince pour poser les approximateurs
 06-0485 - 06-0488, avec fermeture

Pinza per applicazione approssimatori
 06-0485 - 06-0488, con fermo

1/2

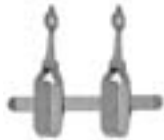

1/1

MÜLLER
 06-0485
 - 06-0488

Maul schräg gerieft
 Oblique serrations
 Boca estriada al oblicuo
 Mors striés en oblique
 Morsi a zigrinatura obliqua

Kat. Nr.
 Cat. ref.
 Núm. de cat.
 No. de cat.
 No di cat.

Durchmesser
 Diameter
 Diámetro
 Diamètre
 Diametro

Schließdruck
 Occlusion pressure
 Presión de oclusión
 Pression d'occlusion
 Pressione occlusiva

| | | | |
|--|-----------|------|-----------|
| | 06-0485 | 1 mm | 25-30 gr. |
| | ▶ 06-0486 | 2 mm | 25-30 gr. |
| | 06-0487 | 3 mm | 25-30 gr. |
| | 06-0488 | 4 mm | 25-30 gr. |



- Der Abstand zwischen den Clips ist variabel und wird mit einem Schlüssel fixiert.
- The distance between the clips is variable and fixed with a key.
- La distancia entre los clips es variable y se fija con una llave.
- La distance entre les clips est variable et se fixe avec une clef
- La distanza tra i clips è variabile e bloccata con chiave



06-0489

Approximator mit Schlüssel, für Mikro-Gefäßanastomosen im tieferen Bereich. Schließdruck wird mit dem Schlüssel eingestellt.

Approximator with key, for micro vessel anastomosis in the deeper range. The pressure measure is adjusted with the key.

Aproximador con llave, para anastomosis micro-vascular en la profundidad. Presión de oclusión se ajusta con la llave.

Approximateur avec clef, pour anastomose micro vasculaire en profondeur. Pression de l'occlusion ajustable avec la clef.

Approssimatore con chiave, per anastomosi micro-vascolare in profondità pressione di occlusione regolabile con chiave.

06-0490

Schlüssel allein
 Key only
 Llave suelta
 Clef seule
 Sola chiave

06-0491

Approximator allein
 Approximator only
 Aproximador suelto
 Approximateur seul
 solo approssimatore

- Der Abstand zwischen den Nadeln ist variabel und wird mit einem Schlüssel fixiert.
- The distance between the needles is variable and fixed with a key.
- La distancia entre las agujas es variable y se fija con una llave.
- La distance entre les aiguilles est variable et se fixe avec une clef
- La distanza tra gli aghi è variabile e bloccata con chiave



06-0492

Nerv-Approximator mit Schlüssel, zur sicheren Adaption bei Nervanastomosen. Nadeln mit Schlüssel auswechselbar.

Approximator for nerves with key, for safe adaptation of nerve anastomoses. The needles can be exchanged with the key.

Aproximador para nervios con llave, para asegurar la adaptación de anastomosis de nervios. Las agujas se pueden cambiar con la llave.

Approximateur pour nerfs avec clef, bien adapté à l'anastomose des nerfs. Les aiguilles peuvent être changées avec la clef.

Approssimatore per nervi con chiave, per adattamento sicura a l'anastomose dei nervi. Aghi di ricambio con chiave.

06-0490

Schlüssel allein
 Key only
 Llave suelta
 Clef seule
 Sola chiave

06-0493

Nerv- Approximator allein
 Approximator for nerves, only
 Aproximador para nervios, suelto
 Approximateur pour nerfs, seul
 solo approssimatore per nervi

06-0494

1 Paar Ersatznadeln
 1 Pair of spare needles
 1 par de agujas de repuesto
 1 paire d'aiguilles de rechange
 1 paio di aghi di ricambio



TITAN-LINE Bulldogklemmen aus Titan
 TITAN-LINE Bulldog Clamps, made of Titanium
 TITAN-LINE Clamps Bulldog, de titanio
 TITAN-LINE Clamps Bulldog en Titane
 TITAN-LINE Pinze Bulldog in Titanio



30-0999
 23 cm, 9"

Anlege- und Entfernungszange
 für TITAN-LINE Bulldogklemmen
 30-0960 - 30-0997

Applying and removing forceps
 for TITAN-LINE Bulldog clamps
 30-0960 - 30-0997

Pinza para poner y quitar
 TITAN-LINE clamps Bulldog
 30-0960 - 30-0997

Pince pour poser et retirer les clamps
 Bulldog TITAN-LINE 30-0960 - 30-0997

1/2 Pinze metti-rimuovi clamps Bulldog
 TITAN-LINE 30-0960 - 30-0997

Kennzeichnung bei TITAN-LINE Bulldogklemmen:

Identification on TITAN-LINE Bulldog clamps:

Identificación de TITAN-LINE clamps Bulldog:

Identification des clamps Bulldog TITAN-LINE

Identificazione dei clamps Bulldog TITAN-LINE



V (Vena) = schwacher Druck
 V (Vena) = low pressure
 V (Vena) = Presión floja
 V (Veine) = Pression faible
 V (Vena) = Pressione bassa



A (Arteria) = starker Druck
 A (Arteria) = high pressure
 A (Arteria) = Presión fuerte
 A (Artère) = Pression forte
 A (Arteria) = Pressione alta

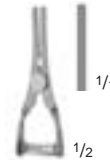
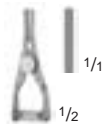

| Kennzeichnung Identification Identificación Identification Identificazione | V = Vena | A = Arteria | V = Vena | A = Arteria | V = Vena | A = Arteria | V = Vena | A = Arteria |
|--|--------------|--------------|--------------|--------------|--------------|--------------|--------------|--------------|
| Kat. Nr. Cat. ref. Núm. de cat. No. de cat. No di cat. | 30-0980 | 30-0960 | 30-0982 | 30-0962 | 30-0984 | 30-0964 | 30-0986 | 30-0966 |
| Länge Length Longitud Longeur Lungh. | 30 mm | | 35 mm | | 40 mm | | 50 mm | |
| Maullänge Length of jaw Longitud de boca Longueur des mors Lungh. dei morsi | 9 mm | | 13 mm | | 14 mm | | 23 mm | |
| Schließdruck Occlusion pressure Presión de oclusión Pression d'occlusion Pressione occlusiva | 110 ± 10 gr. | 220 ± 10 gr. | 110 ± 10 gr. | 220 ± 10 gr. | 110 ± 10 gr. | 220 ± 10 gr. | 110 ± 10 gr. | 220 ± 10 gr. |
| Gewicht Weight Peso Poids Peso | 1 gr. | | 1 gr. | | 1 gr. | | 1,5 gr. | |

TITAN-LINE Bulldogklemmen aus Titan
 TITAN-LINE Bulldog Clamps, made of Titanium
 TITAN-LINE Clamps Bulldog, de titanio
 TITAN-LINE Clamps Bulldog en Titane
 TITAN-LINE Pinze Bulldog in Titanio

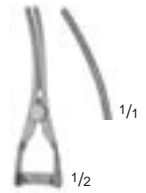
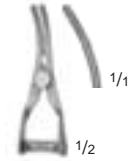
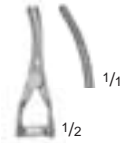
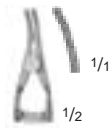

| | | | | | | | | |
|--|--------------|--------------|--------------|--------------|--------------|--------------|--------------|--------------|
| Kennzeichnung Identification Identificación Identification Identificazione | V = Vena | A = Arteria | V = Vena | A = Arteria | V = Vena | A = Arteria | V = Vena | A = Arteria |
| Kat. Nr. Cat. ref. Núm. de cat. No. de cat. No di cat. | 30-0991 | 30-0971 | 30-0993 | 30-0973 | 30-0995 | 30-0975 | 30-0997 | 30-0977 |
| Länge Length Longitud Longeur Lungh. | 30 mm | | 35 mm | | 40 mm | | 48 mm | |
| Maullänge Length of jaw Longitud de boca Longueur des mors Lungh. dei morsi | 9 mm | | 13 mm | | 14 mm | | 22 mm | |
| Schließdruck Occlusion pressure Presión de oclusión Pression d'occlusion Pressione occlusiva | 110 ± 10 gr. | 220 ± 10 gr. | 110 ± 10 gr. | 220 ± 10 gr. | 110 ± 10 gr. | 220 ± 10 gr. | 110 ± 10 gr. | 220 ± 10 gr. |
| Gewicht Weight Peso Poids Peso | 1 gr. | | 1 gr. | | 1 gr. | | 1,5 gr. | |

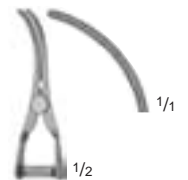
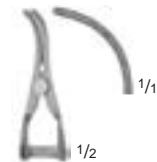

| | | | | | | | | |
|--|--------------|--------------|--------------|--------------|--------------|--------------|--------------|--------------|
| Kennzeichnung Identification Identificación Identification Identificazione | V = Vena | A = Arteria | V = Vena | A = Arteria | V = Vena | A = Arteria | V = Vena | A = Arteria |
| Kat. Nr. Cat. ref. Núm. de cat. No. de cat. No di cat. | 30-0981 | 30-0961 | 30-0983 | 30-0963 | 30-0985 | 30-0965 | 30-0987 | 30-0967 |
| Länge Length Longitud Longeur Lungh. | 30 mm | | 35 mm | | 40 mm | | 45 mm | |
| Maullänge Length of jaw Longitud de boca Longueur des mors Lungh. dei morsi | 10 mm | | 14 mm | | 15 mm | | 21 mm | |
| Schließdruck Occlusion pressure Presión de oclusión Pression d'occlusion Pressione occlusiva | 110 ± 10 gr. | 220 ± 10 gr. | 110 ± 10 gr. | 220 ± 10 gr. | 110 ± 10 gr. | 220 ± 10 gr. | 110 ± 10 gr. | 220 ± 10 gr. |
| Gewicht Weight Peso Poids Peso | 1 gr. | | 1 gr. | | 1 gr. | | 1,5 gr. | |



Mikro-Bulldogklemmen
 Micro Bulldog Clamps
 Micro-Clamps Bulldog
 Micro Clamps Bulldog
 Micro Pinze Bulldog

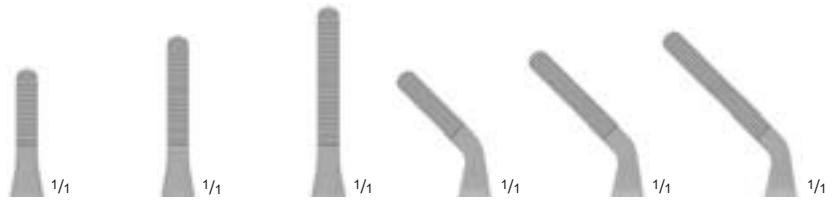

| | | | | | | |
|--|------------|------------|------------|------------|------------|------------|
| Kat. Nr. Cat. ref. Núm. de cat. No. de cat. No di cat. | 06-0064 | 06-0065 | ▶ 06-0066 | 06-0067 | 06-0068 | 06-0069 |
| Länge Length Longitud Longeur Lungh. | 31 mm | 35 mm | 39 mm | 30 mm | 33 mm | 36 mm |
| Maullänge Length of jaw Longitud de boca Longueur des mors Lungh. dei morsi | 10 mm | 14 mm | 18 mm | 10 mm | 14 mm | 18 mm |
| Schließdruck Occlusion pressure Presión de oclusión Pression d'occlusion Pressione occlusiva | 30 ± 5 gr. | 30 ± 5 gr. | 30 ± 5 gr. | 30 ± 5 gr. | 30 ± 5 gr. | 30 ± 5 gr. |
| Gewicht Weight Peso Poids Peso | 1 gr. | 1 gr. | 1 gr. | 1 gr. | 1 gr. | 1 gr. |



06-0064
- 06-0069

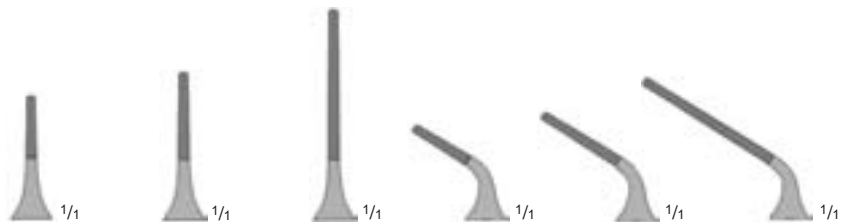

| | | | | | | |
|--|------------|------------|------------|------------|------------|------------|
| Kat. Nr. Cat. ref. Núm. de cat. No. de cat. No di cat. | 06-0070 | 06-0071 | ▶ 06-0072 | 06-0075 | 06-0076 | 06-0077 |
| Länge Length Longitud Longeur Lungh. | 49 mm | 53 mm | 59 mm | 45 mm | 48 mm | 53 mm |
| Maullänge Length of jaw Longitud de boca Longueur des mors Lungh. dei morsi | 8 mm | 12 mm | 20 mm | 8 mm | 12 mm | 20 mm |
| Schließdruck Occlusion pressure Presión de oclusión Pression d'occlusion Pressione occlusiva | 60 ± 5 gr. | 60 ± 5 gr. | 60 ± 5 gr. | 60 ± 5 gr. | 60 ± 5 gr. | 60 ± 5 gr. |
| Gewicht Weight Peso Poids Peso | 3 gr. | 3 gr. | 3 gr. | 3 gr. | 3 gr. | 3 gr. |



DIETRICH
06-0070
- 06-0077



DIEFFENBACH
 06-0010
 - 06-0015

- ▶ 06-0010
38 mm
- 06-0014
48 mm
- 06-0011
38 mm
- 06-0015
48 mm



DIEFFENBACH
 06-0012
 - 06-0013

- ▶ 06-0012
58 mm
- 06-0013
58 mm



JOHNS-HOPKINS
 06-0020
 - 06-0033

- 06-0020
37 mm
- 06-0022
47 mm
- 06-0024
58 mm
- 06-0026
65 mm
- ▶ 06-0028
70 mm
- 06-0030
76 mm
- 06-0032
91 mm

- 06-0021
37 mm
- 06-0023
47 mm
- 06-0025
58 mm
- 06-0027
65 mm
- 06-0029
70 mm
- 06-0031
76 mm
- 06-0033
91 mm



Feine Arterienklemmen
 Delicate Haemostatic Forceps
 Pinzas hemostáticas finas
 Pincès hémostatiques fines
 Pinze emostatiche fini

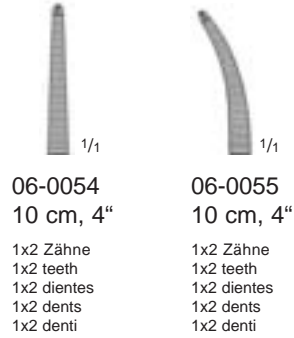
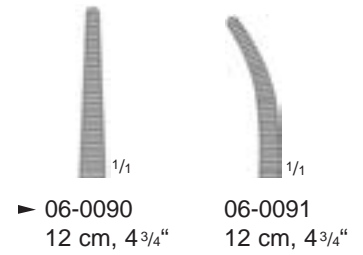
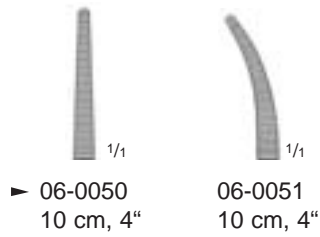

BABY-MOSQUITO
 (HARTMANN)
 06-0050
 - 06-0055

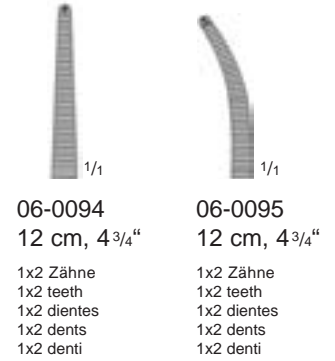

MICRO-HALSTED
 06-0090
 - 06-0095

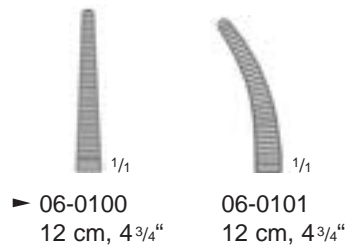

aus TITAN
 made of TITANIUM
 de TITANIO
 en TITANE
 in TITANIO

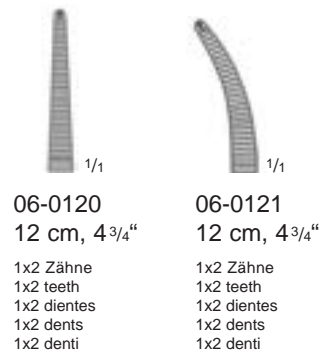
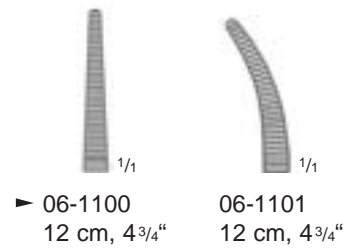

HALSTED-MOSQUITO
 06-0100
 - 06-0121

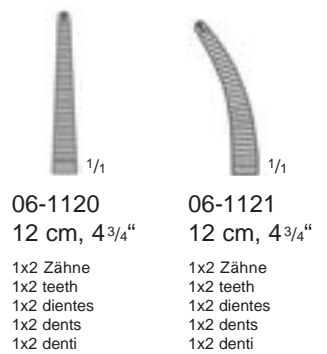

HALSTED-MOSQUITO
 06-1100
 - 06-1121

Feine Arterienklemmen
 Delicate Haemostatic Forceps
 Pinzas hemostáticas finas
 Pincas hémostatiques fines
 Pinze emostatiche fini



mit atraumatischer Riefung
 with non-traumatic serration
 con bocas atraumáticas
 avec mors atrauma
 con morsi atraumatici

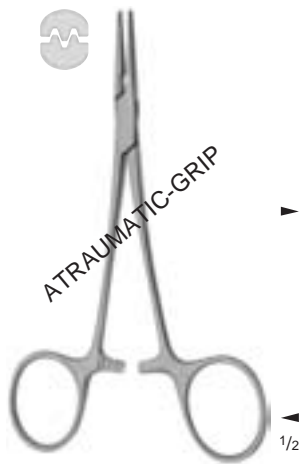

HALSTED-MOSQUITO-DE BAKEY
 06-0122
 - 06-0123

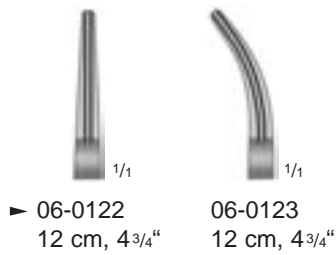

HALSTED-MOSQUITO
 06-0155
 - 06-0158

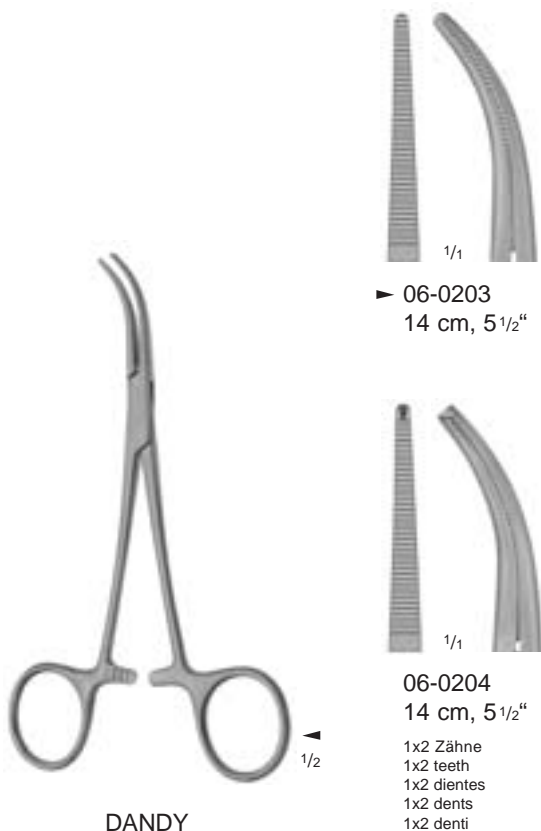
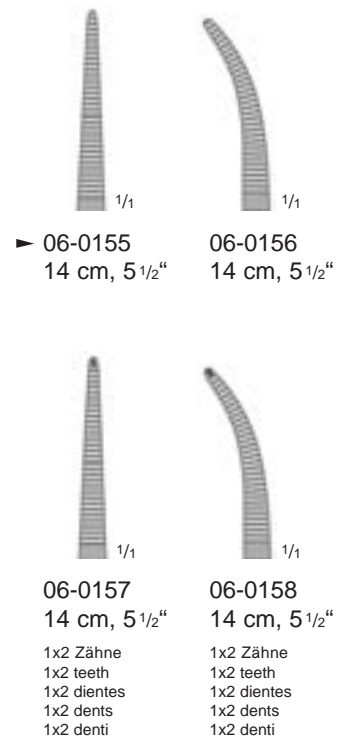

DANDY
 06-0203
 - 06-0204

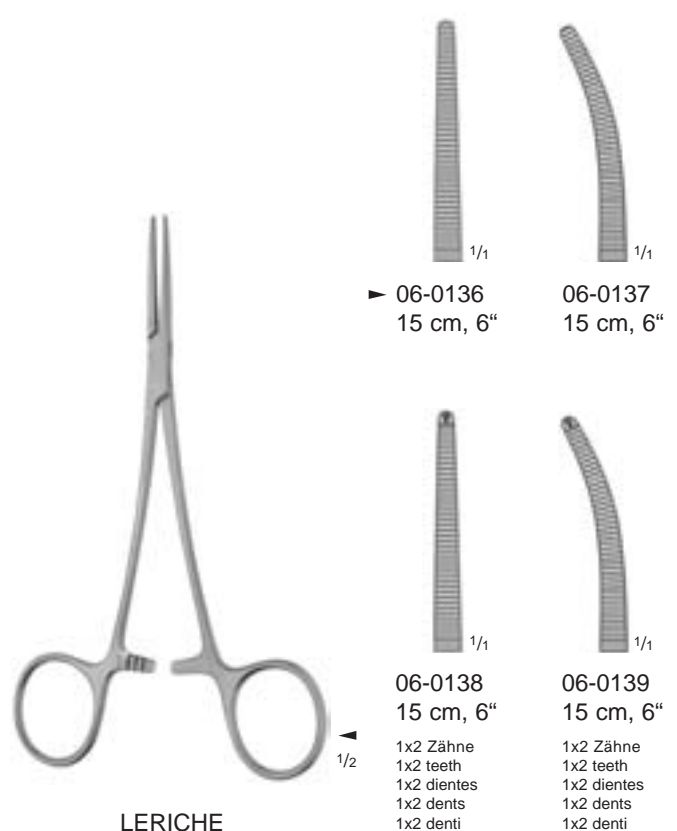

LERICHE
 06-0136
 - 06-0139



Feine Arterienklemmen
 Delicate Haemostatic Forceps
 Pinzas hemostáticas finas
 Pinces hémostatiques fines
 Pinze emostatiche fini

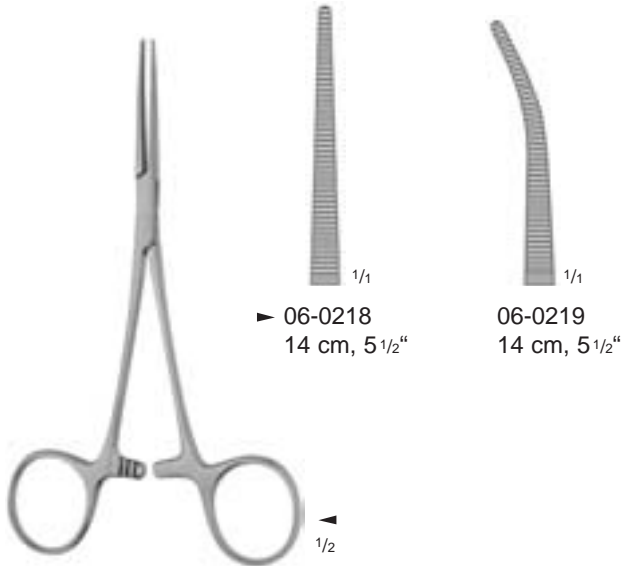

► 06-0218
14 cm, 5 1/2"

06-0219
14 cm, 5 1/2"

MICRO-CRILE
 06-0218
 - 06-0219

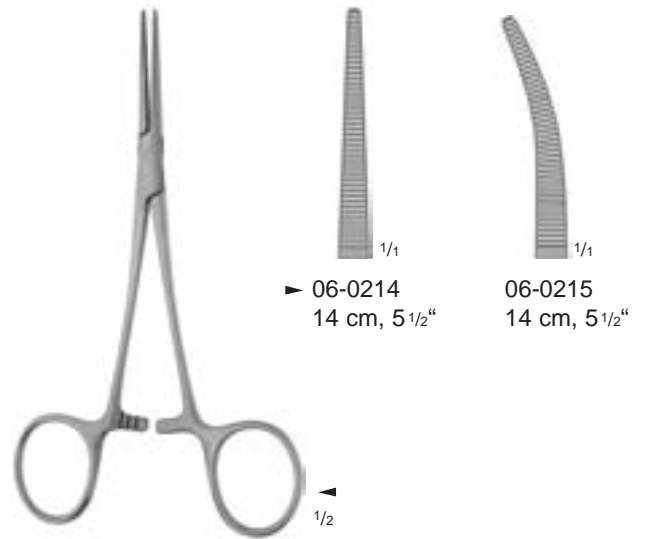

► 06-0214
14 cm, 5 1/2"

06-0215
14 cm, 5 1/2"

BABY-CRILE
 06-0214
 - 06-0215

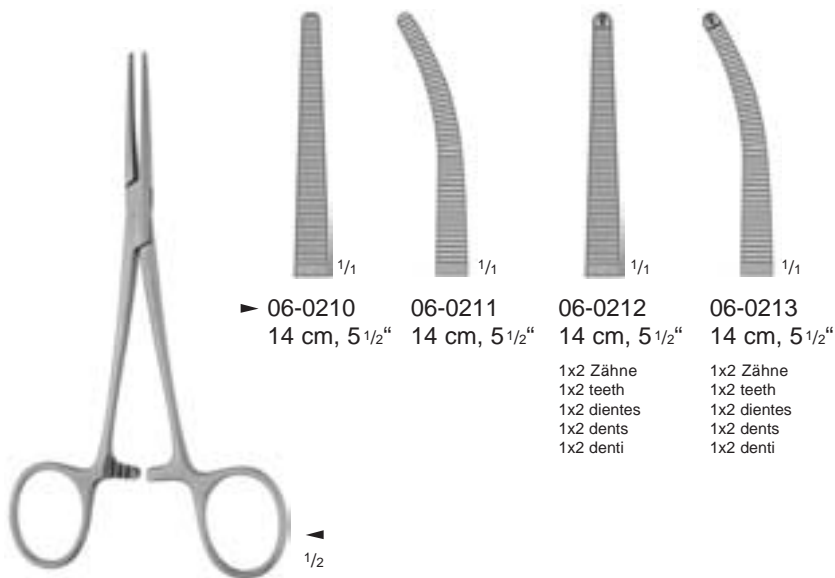

► 06-0210
14 cm, 5 1/2"

06-0211
14 cm, 5 1/2"

06-0212
14 cm, 5 1/2"

06-0213
14 cm, 5 1/2"

1x2 Zähne
 1x2 teeth
 1x2 dientes
 1x2 dents
 1x2 denti

1x2 Zähne
 1x2 teeth
 1x2 dientes
 1x2 dents
 1x2 denti

CRILE
 06-0210
 - 06-0213

aus TITAN
 made of TITANIUM
 de TITANIO
 en TITANE
 in TITANIO

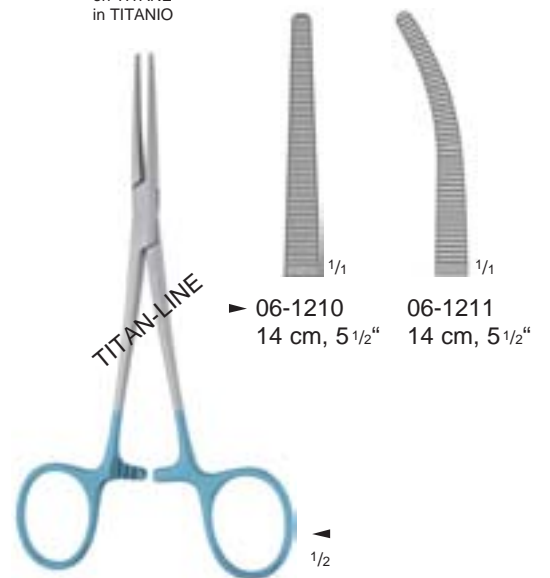

► 06-1210
14 cm, 5 1/2"

06-1211
14 cm, 5 1/2"

CRILE
 06-1210
 - 06-1211

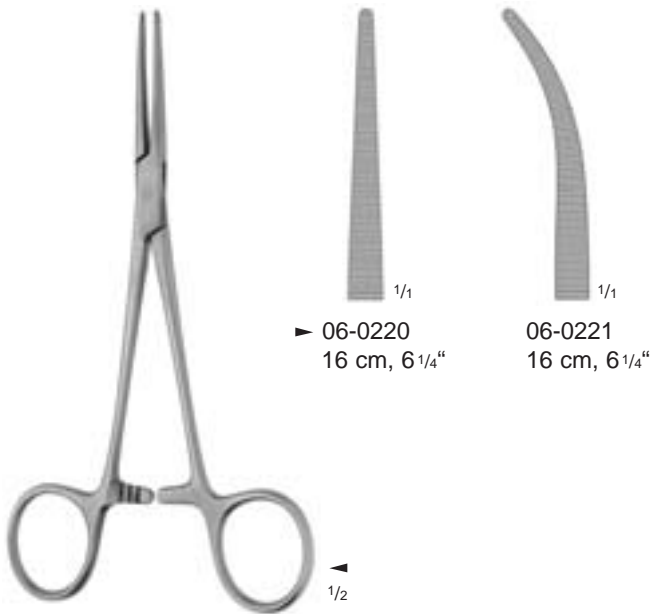

CRILE-RANKIN
 06-0220
 - 06-0221

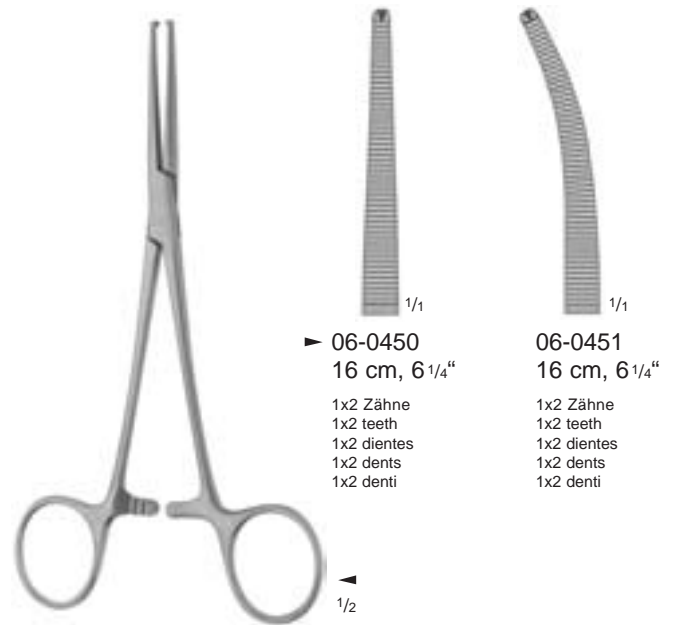

CRILE-RANKIN
 (OCHSNER-DIXON)
 06-0450
 - 06-0451

mit atraumatischer Riefung
 with non-traumatic serration
 con bocas atraumáticas
 avec mors atrauma
 con morsi atraumatici

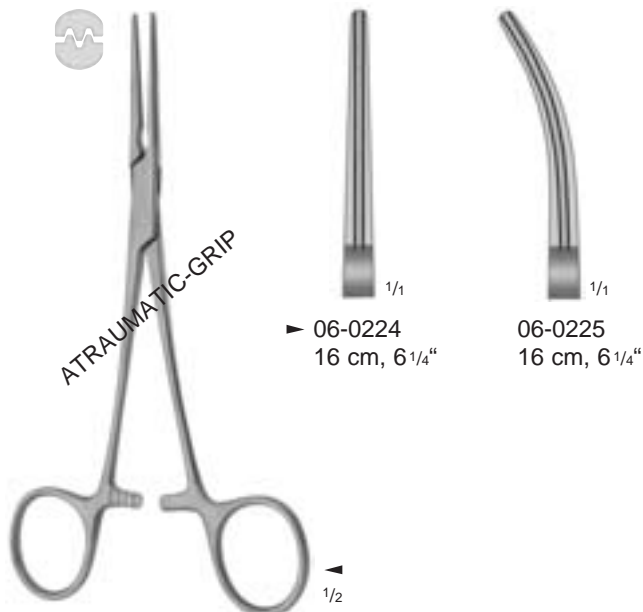

CRILE-RANKIN-DE BAKKEY
 06-0224
 - 06-0225

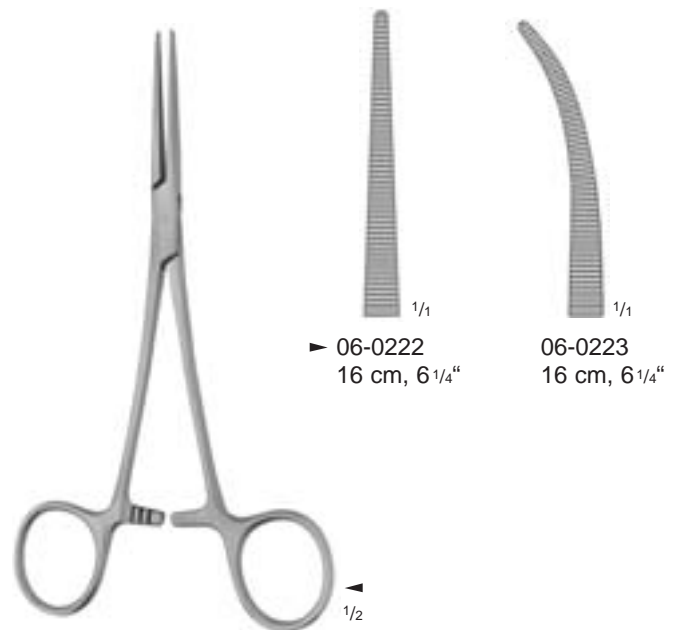

CRILE-COLLER
 06-0222
 - 06-0223



Feine Arterienklemmen
 Delicate Haemostatic Forceps
 Pinzas hemostáticas finas
 Pinces hémostatiques fines
 Pinze emostatiche fini

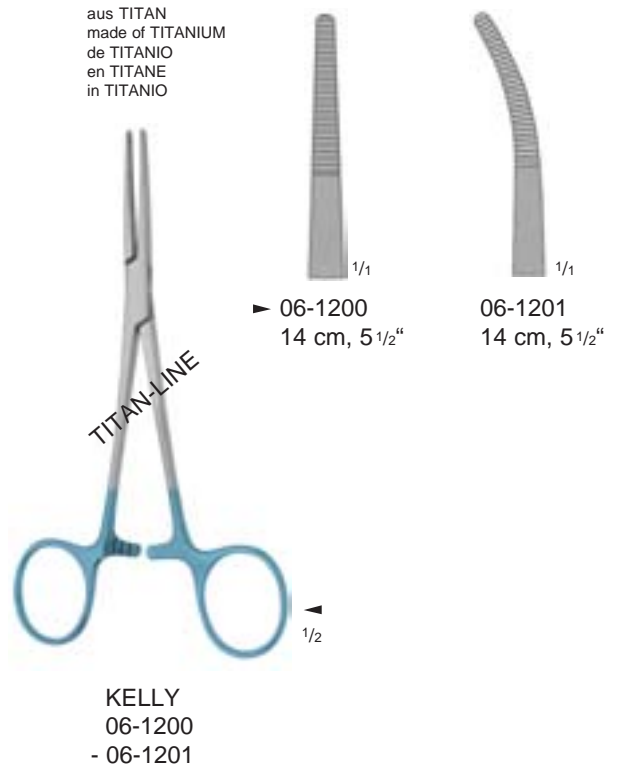
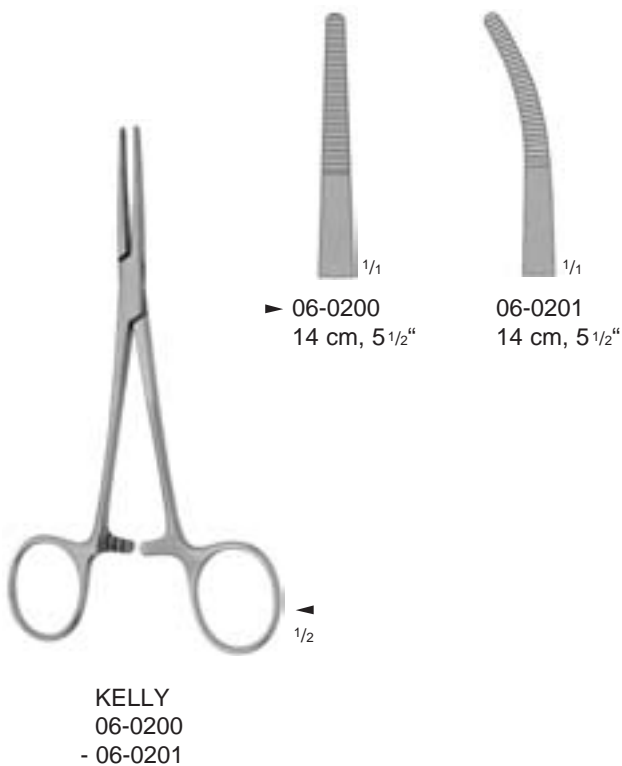
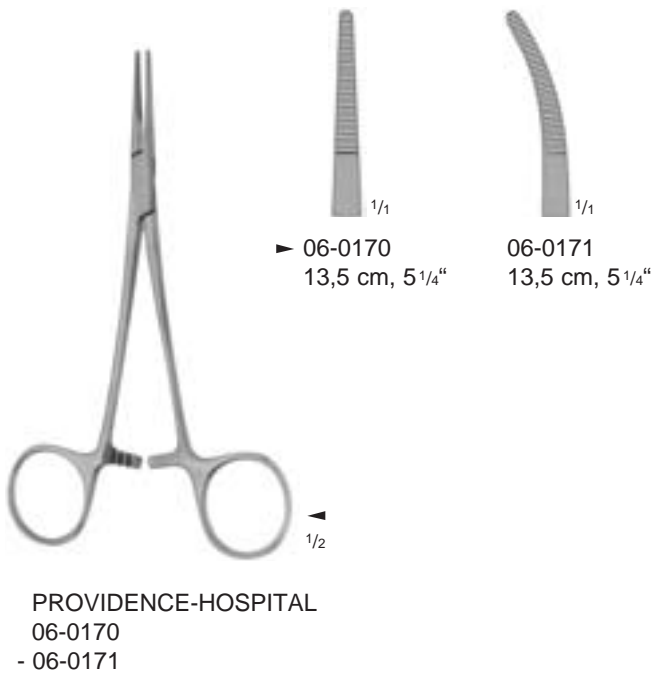

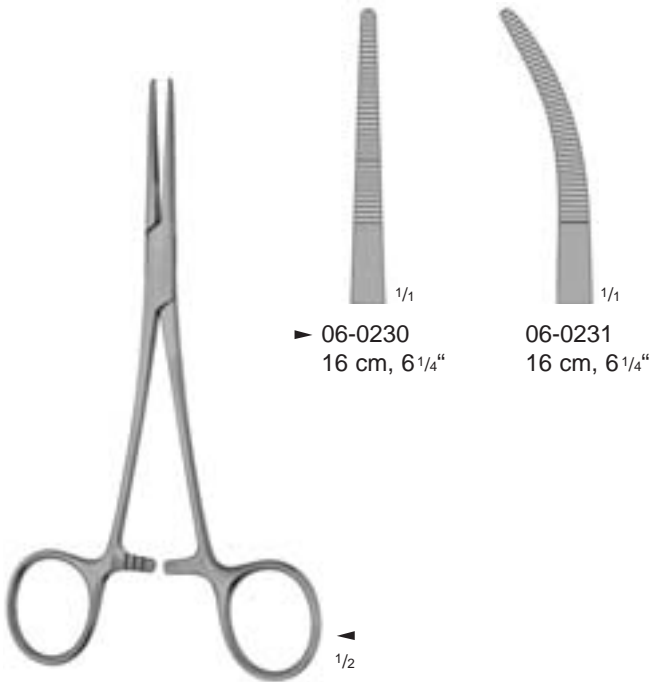

▶ 06-0230
16 cm, 6 1/4"

06-0231
16 cm, 6 1/4"

KELLY-RANKIN
06-0230
- 06-0231

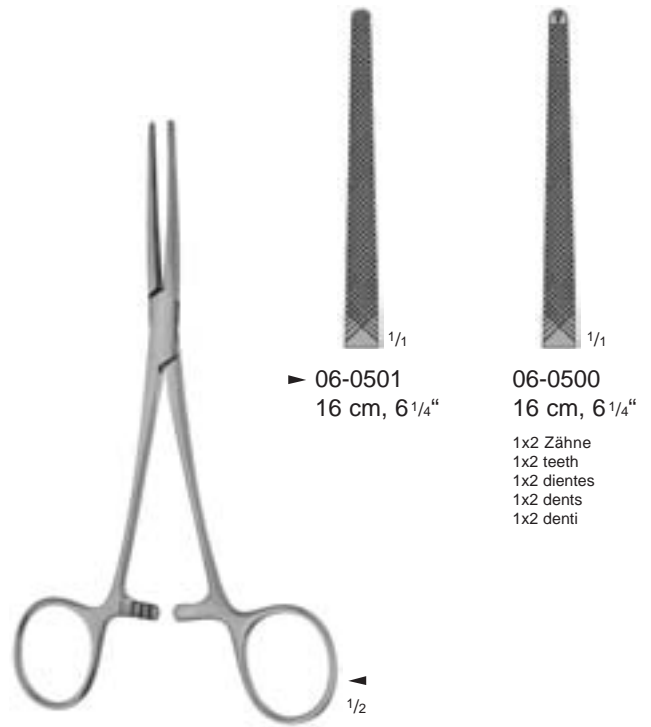

▶ 06-0501
16 cm, 6 1/4"

06-0500
16 cm, 6 1/4"

1x2 Zähne
1x2 teeth
1x2 dientes
1x2 dents
1x2 denti

DIXON-LOVELACE
06-0500
- 06-0501



▶ 06-0240
18,5 cm, 7 1/4"

06-0241
18,5 cm, 7 1/4"

06-0244
18,5 cm, 7 1/4"

06-0245
18,5 cm, 7 1/4"

1x2 Zähne
1x2 teeth
1x2 dientes
1x2 dents
1x2 denti

1x2 Zähne
1x2 teeth
1x2 dientes
1x2 dents
1x2 denti

HALSTED
06-0240
- 06-0245

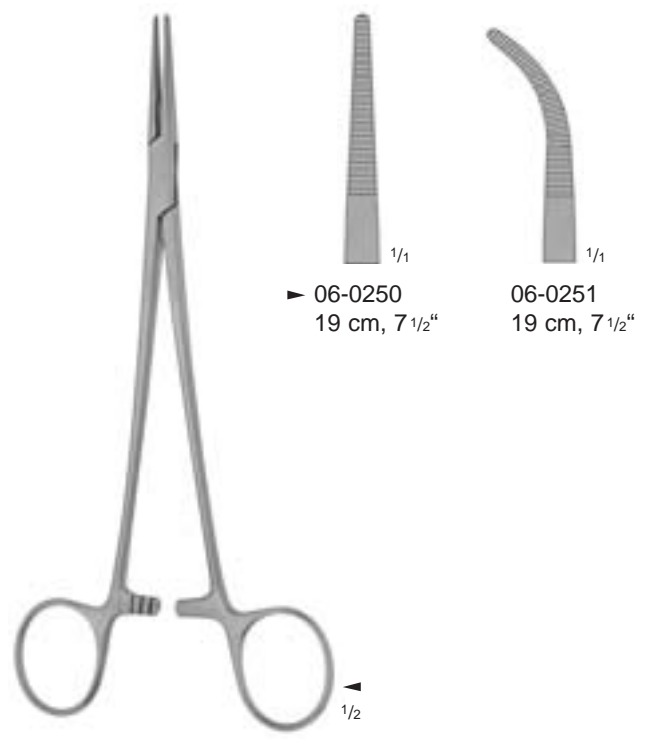

▶ 06-0250
19 cm, 7 1/2"

06-0251
19 cm, 7 1/2"

ADSON
06-0250
- 06-0251



Feine Arterienklemmen
 Delicate Haemostatic Forceps
 Pinzas hemostáticas finas
 Pinces hémostatiques fines
 Pinze emostatiche fini

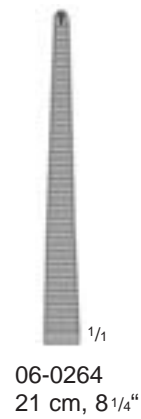
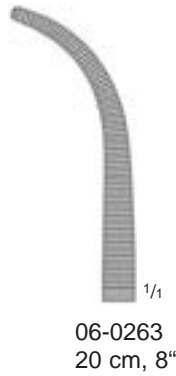

1x2 Zähne
 1x2 teeth
 1x2 dientes
 1x2 dents
 1x2 denti

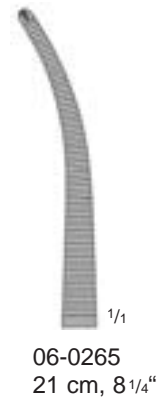

1x2 Zähne
 1x2 teeth
 1x2 dientes
 1x2 dents
 1x2 denti

HEISS (HALSTED-MOSQUITO)
 06-0260
 - 06-0265

1/2



VARCO
 06-0713
 18,5 cm, 7 1/4"



STILLE-CRAFOORD
 06-0276
 18,5 cm, 7 1/4"

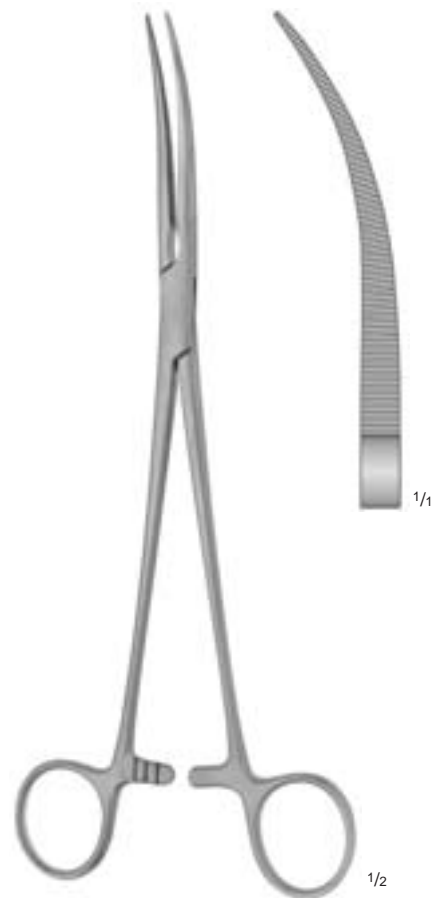

STILLE-CRAFOORD
 06-0277
 23,5 cm, 9 1/4"

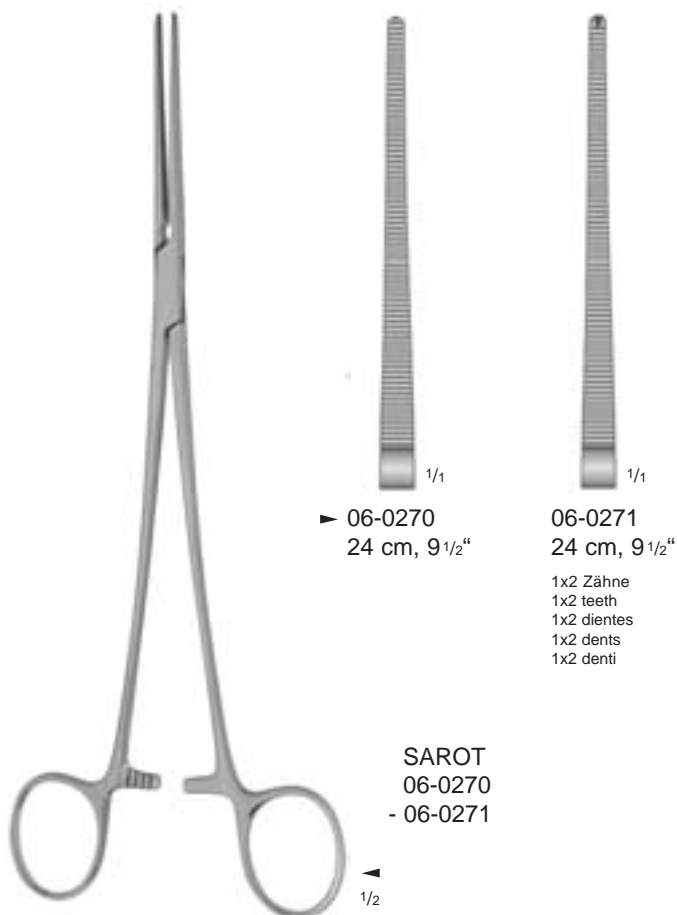
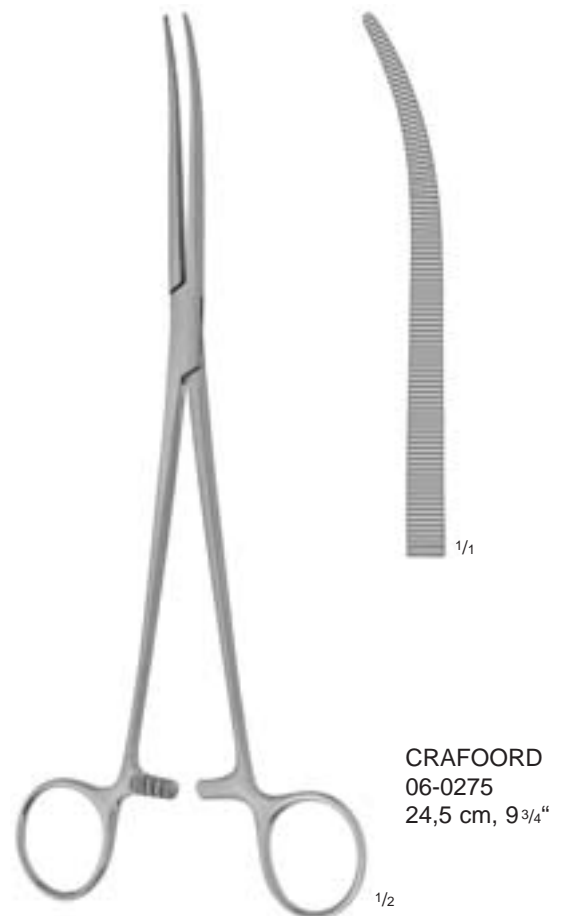
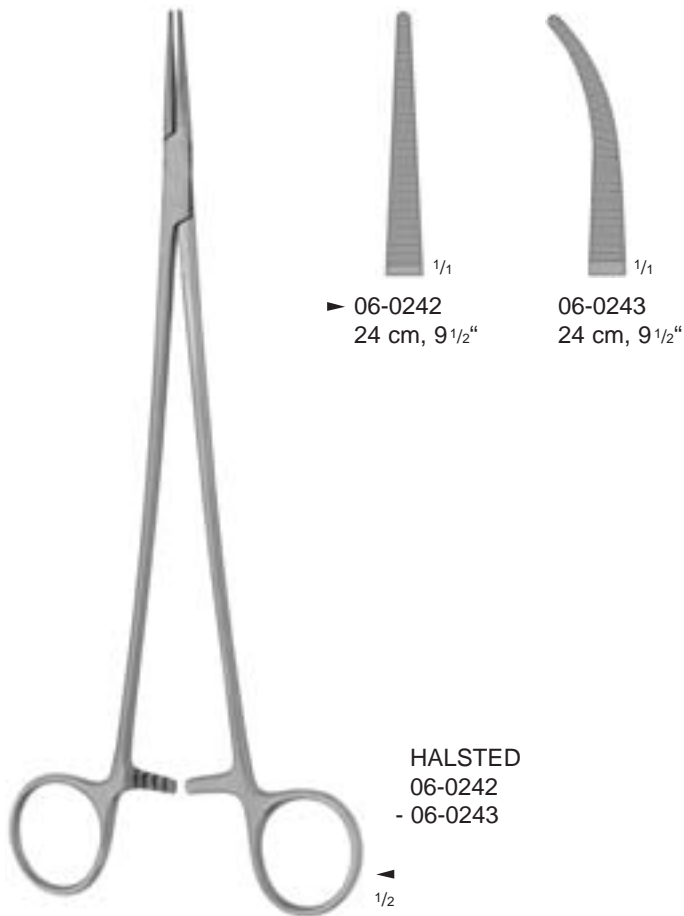



Feine Arterienklemmen
 Delicate Haemostatic Forceps
 Pinzas hemostáticas finas
 Pincès hémostatiques fines
 Pinze emostatiche fini



► 06-0280
 21,5 cm, 8 1/2"



06-0284
 25,5 cm, 10"



06-0281
 21,5 cm, 8 1/2"



06-0285
 25,5 cm, 10"



06-0282
 21,5 cm, 8 1/2"
 1x2 Zähne
 1x2 teeth
 1x2 dientes
 1x2 dents
 1x2 denti



06-0286
 25,5 cm, 10"
 1x2 Zähne
 1x2 teeth
 1x2 dientes
 1x2 dents
 1x2 denti



06-0283
 21,5 cm, 8 1/2"
 1x2 Zähne
 1x2 teeth
 1x2 dientes
 1x2 dents
 1x2 denti



06-0287
 25,5 cm, 10"
 1x2 Zähne
 1x2 teeth
 1x2 dientes
 1x2 dents
 1x2 denti



BENGOLEA
 06-0280
 - 06-0287



KROENLEIN
 06-0680
 12,5 cm, 5"



PEAN
 06-0682
 - 06-0685

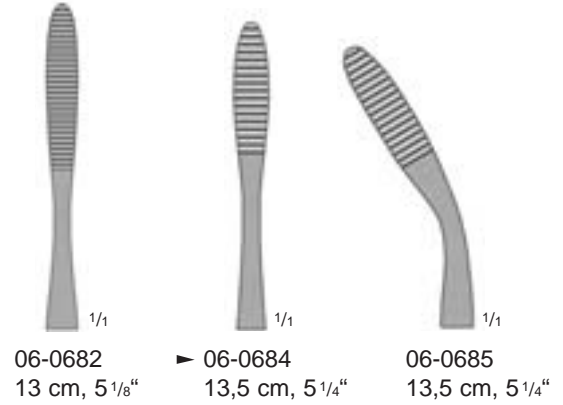

SPENCER-WELLS
 06-0342
 - 06-0354

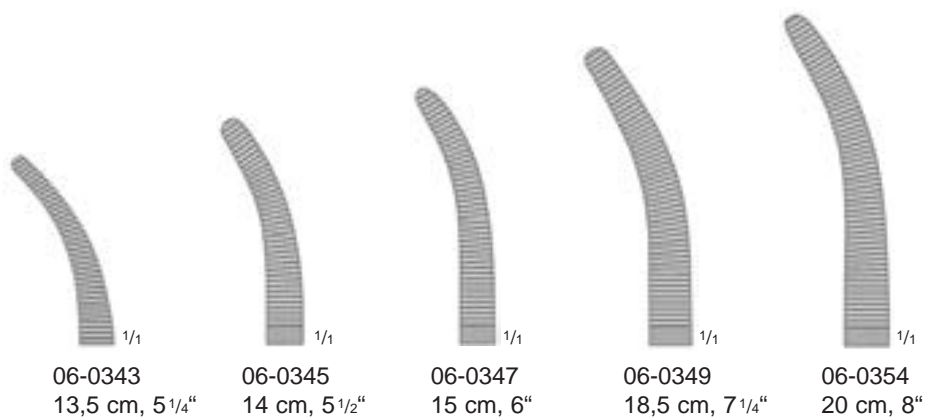
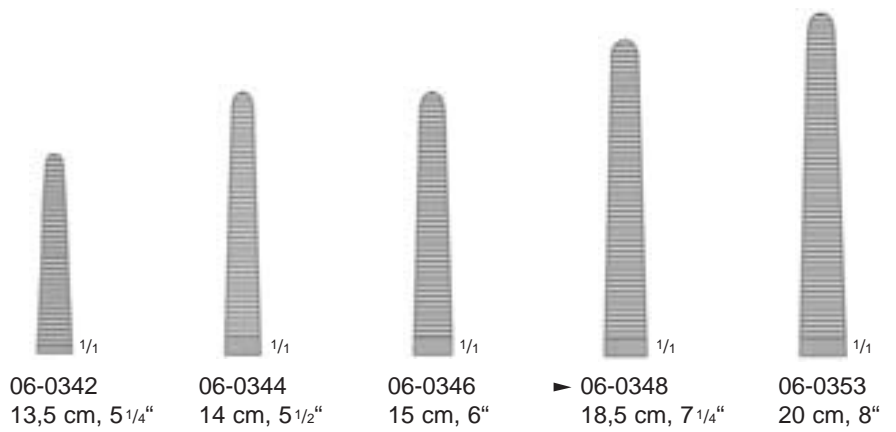



Arterienklemmen
 Haemostatic Forceps
 Pinzas hemostáticas
 Pinces hémostatiques
 Pinze emostatiche

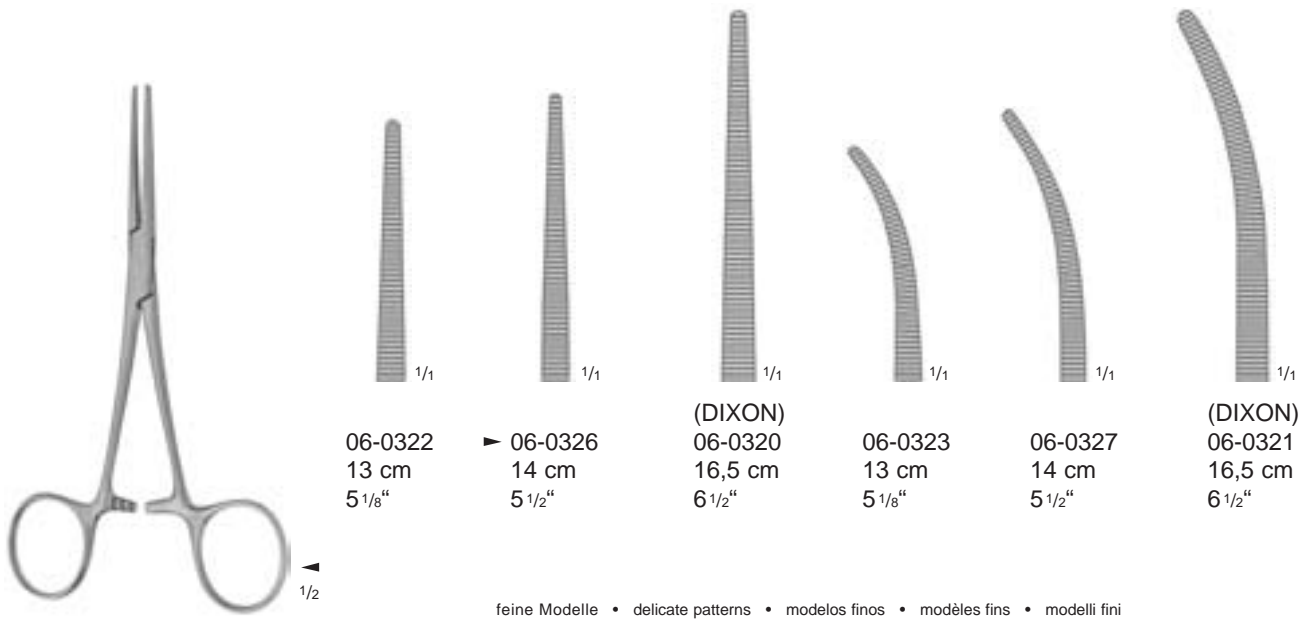

06-0322
 13 cm
 5 1/8"

▶ 06-0326
 14 cm
 5 1/2"

(DIXON)
 06-0320
 16,5 cm
 6 1/2"

06-0323
 13 cm
 5 1/8"

06-0327
 14 cm
 5 1/2"

(DIXON)
 06-0321
 16,5 cm
 6 1/2"

PEAN
 06-0320
 - 06-0327

feine Modelle • delicate patterns • modelos finos • modèles fins • modelli fini

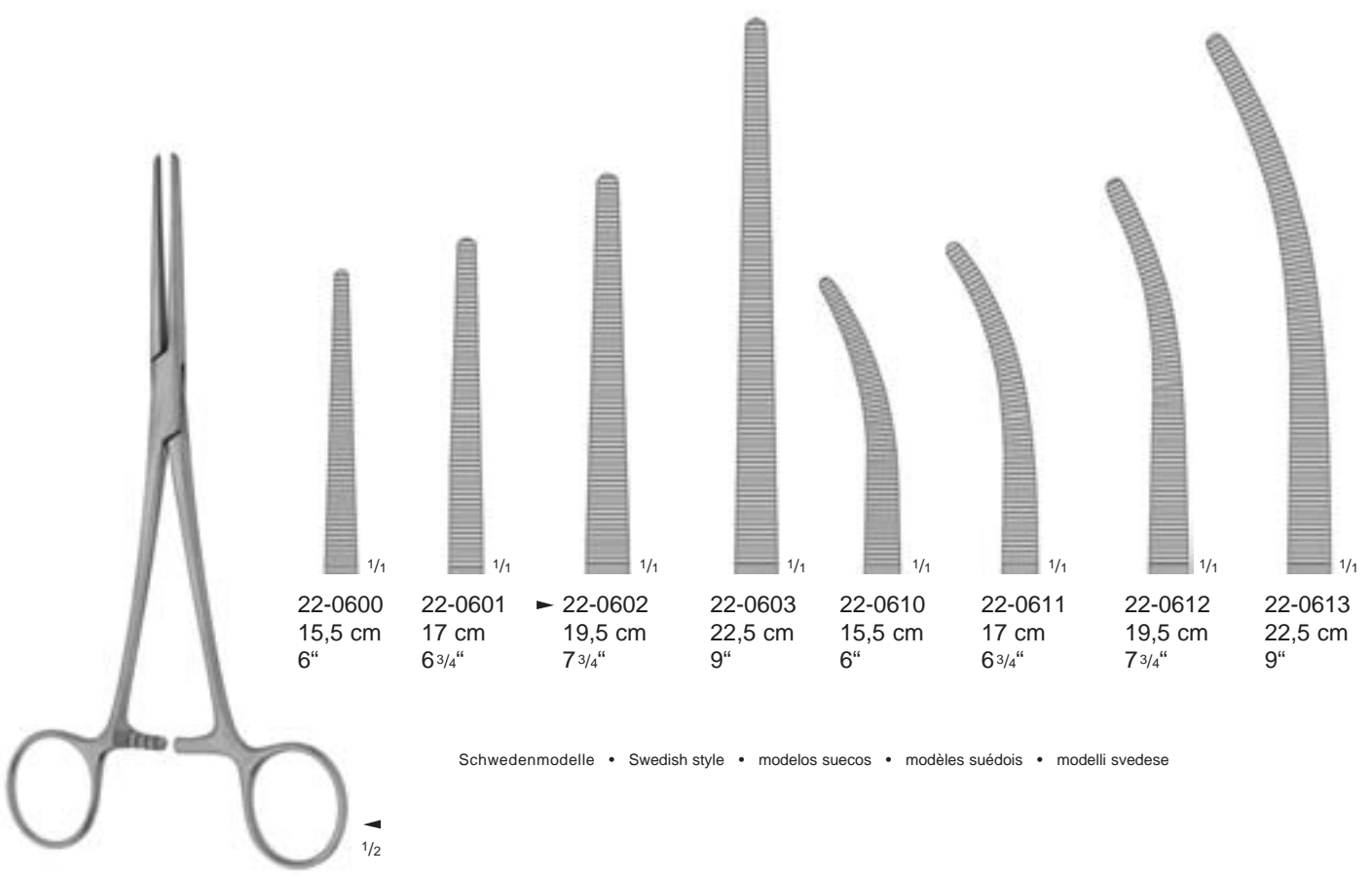

22-0600
 15,5 cm
 6"

22-0601
 17 cm
 6 3/4"

▶ 22-0602
 19,5 cm
 7 3/4"

22-0603
 22,5 cm
 9"

22-0610
 15,5 cm
 6"

22-0611
 17 cm
 6 3/4"

22-0612
 19,5 cm
 7 3/4"

22-0613
 22,5 cm
 9"

PEAN
 22-0600
 - 22-0613

Schwedenmodelle • Swedish style • modelos suecos • modèles suédois • modelli svedese

Arterienklemmen

Haemostatic Forceps
 Pinzas hemostáticas
 Pincas hémostatiques
 Pinze emostatiche

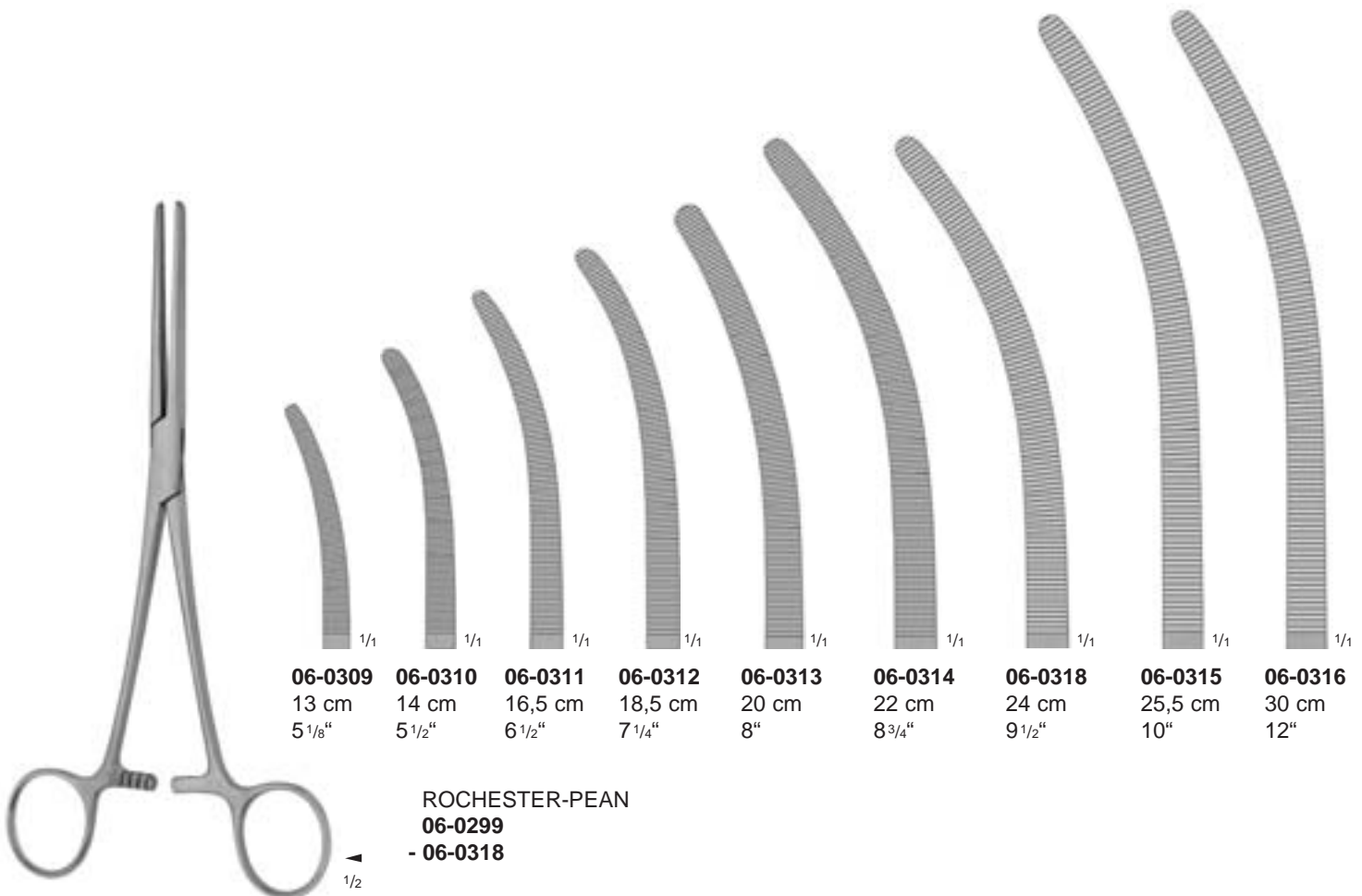
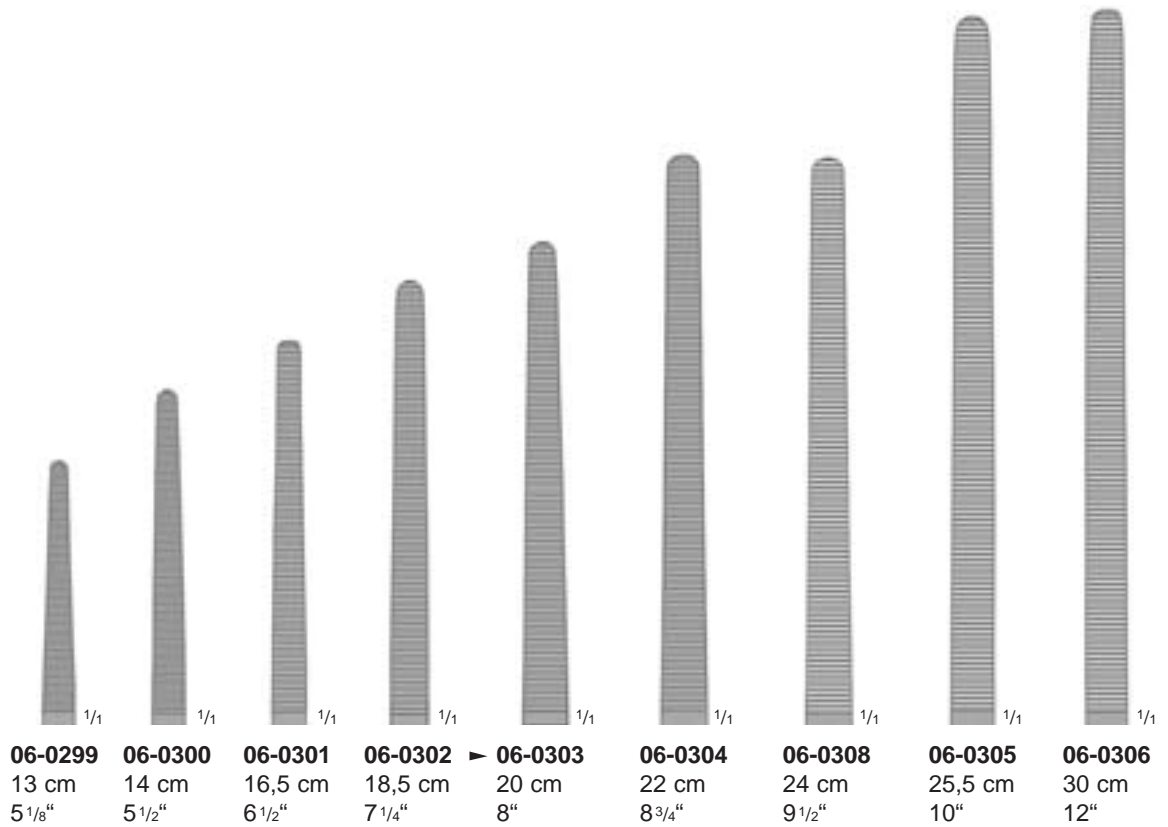









Arterienklemmen
 Haemostatic Forceps
 Pinzas hemostáticas
 Pinces hémostatiques
 Pinze emostatiche







mit atraumatischer Riefung
 with non-traumatic serration
 con bocas atraumáticas
 avec mors atrauma
 con morsi atraumatici



| | | | | | |
|---|---|---|---|---|---|
|  |  |  |  |  |  |
| 06-0420 14 cm 5 1/2" | 06-0421 16,5 cm 6 1/2" | 06-0422 18,5 cm 7 1/4" | 06-0425 14 cm 5 1/2" | 06-0426 16,5 cm 6 1/2" | 06-0427 18,5 cm 7 1/4" |



PEAN-DE BAKEY
06-0420
 - **06-0427**

| | | | |
|---|---|---|---|
|  |  |  |  |
| 06-0458 13 cm 5 1/8" | 06-0216 14 cm 5 1/2" | 06-0459 13 cm 5 1/8" | 06-0217 14 cm 5 1/2" |

feine Modelle, 1x2 Zähne
 delicate patterns, 1x2 teeth
 modelos finos, 1x2 dientes
 modèles fins, 1x2 dents
 modelli fini, 1x2 denti



KOCHER
06-0216
 - **06-0459**

| | |
|---|---|
|  |  |
| 06-0460 14 cm 5 1/2" | 06-0461 14 cm 5 1/2" |

1x2 Zähne
 1x2 teeth
 1x2 dientes
 1x2 dents
 1x2 denti



KOCHER
06-0460
 - **06-0461**

Arterienklemmen

Haemostatic Forceps
Pinzas hemostáticas
Pincas hémostatiques
Pinze emostatiche

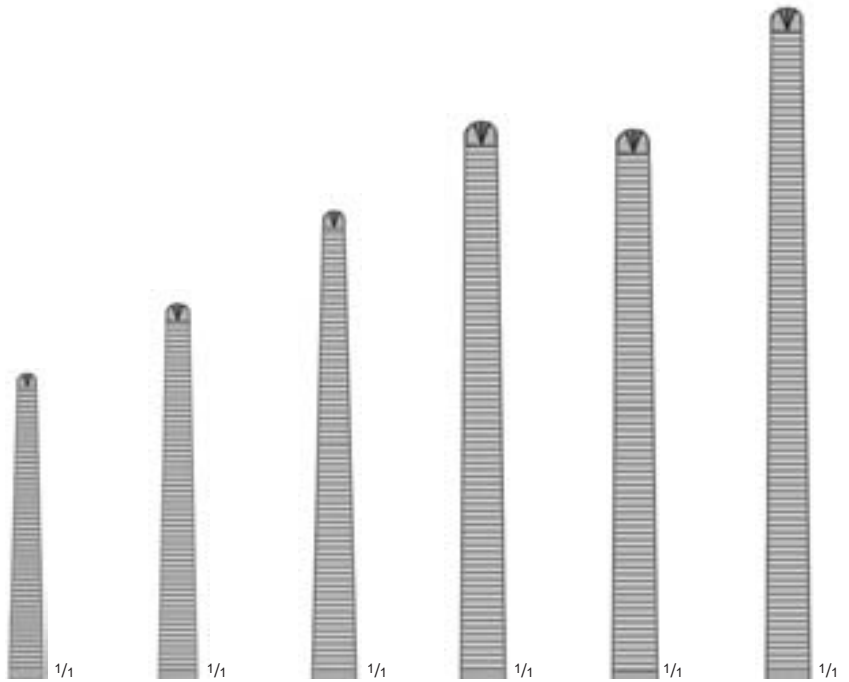

06-0400
16 cm
6 1/4"

06-0401
18,5 cm
7 1/4"

▶ **06-0402**
20 cm
8"

06-0403
22 cm
8 3/4"

06-0406
24 cm
9 1/2"

06-0404
26 cm
10 1/4"

1x2 Zähne • 1x2 teeth • 1x2 dientes • 1x2 dents • 1x2 denti



KOCHER-OCHSNER
06-0400
- **06-0416**

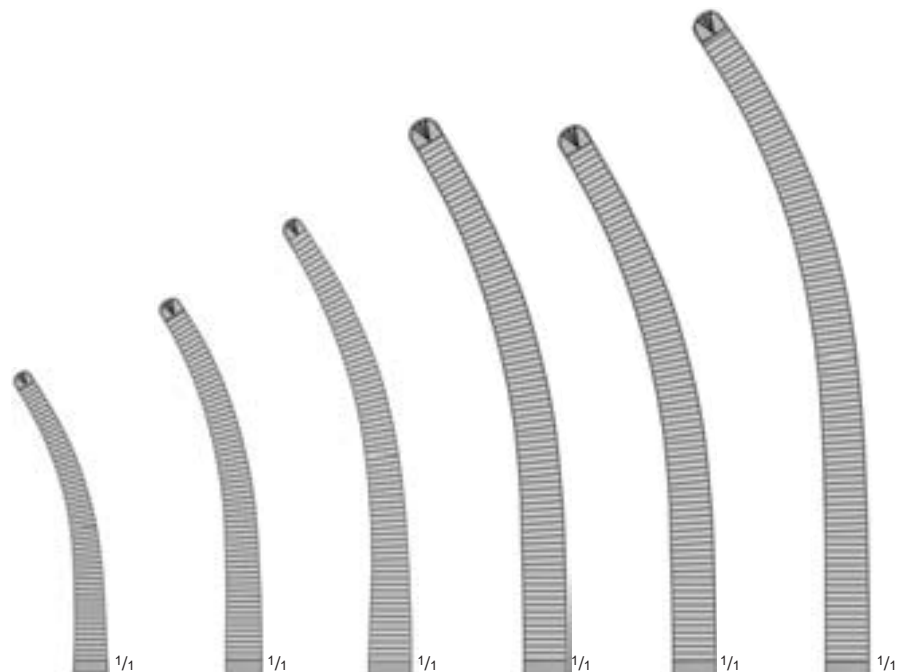

06-0410
16 cm
6 1/4"

06-0411
18,5 cm
7 1/4"

06-0412
20 cm
8"

06-0413
22 cm
8 3/4"

06-0416
24 cm
9 1/2"

06-0414
26 cm
10 1/4"

1x2 Zähne • 1x2 teeth • 1x2 dientes • 1x2 dents • 1x2 denti



Arterienklemmen
 Haemostatic Forceps
 Pinzas hemostáticas
 Pinces hémostatiques
 Pinze emostatiche

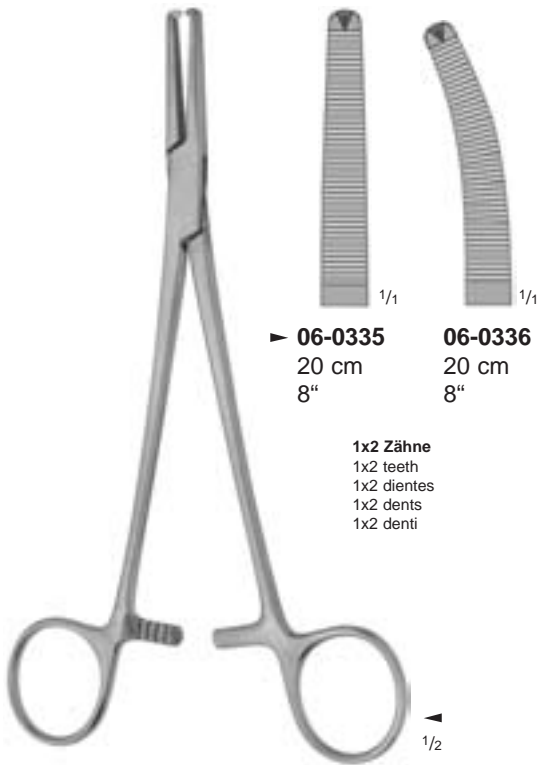

► **06-0335**
20 cm
8"

06-0336
20 cm
8"

1x2 Zähne
 1x2 teeth
 1x2 dientes
 1x2 dents
 1x2 denti

ROCHESTER-OCHSNER
06-0335
 - **06-0336**

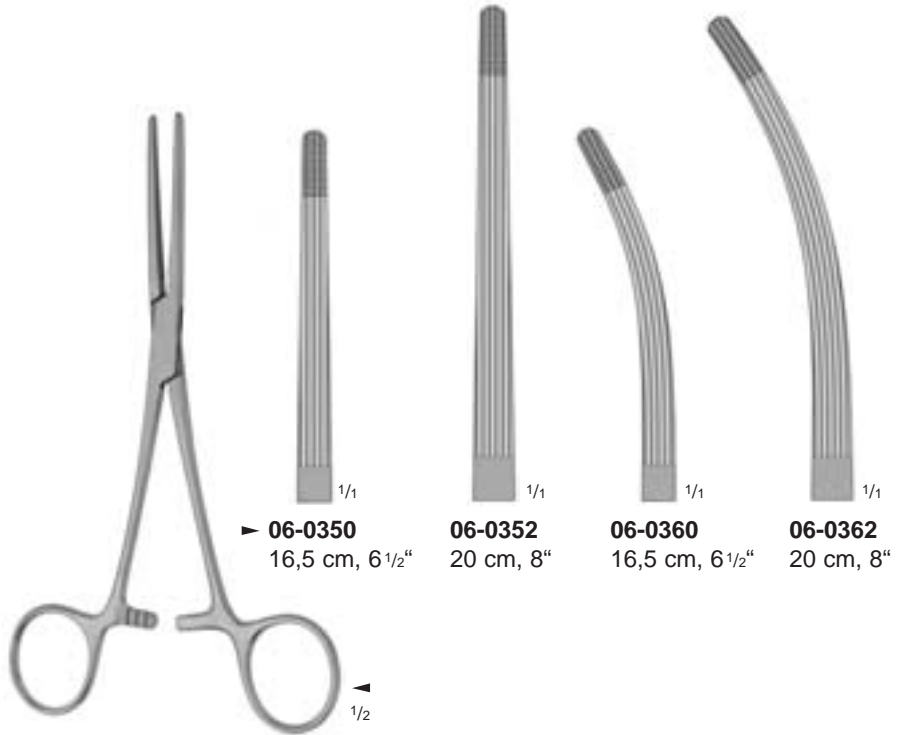

► **06-0350**
16,5 cm, 6 1/2"

06-0352
20 cm, 8"

06-0360
16,5 cm, 6 1/2"

06-0362
20 cm, 8"

ROCHESTER-CARMALT
06-0350
 - **06-0362**

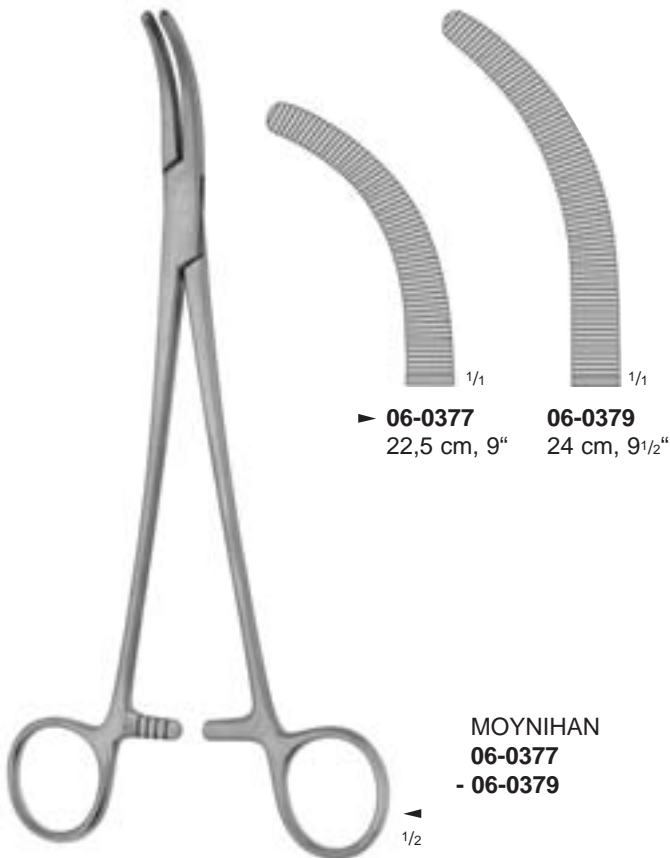

► **06-0377**
22,5 cm, 9"

06-0379
24 cm, 9 1/2"

MOYNIHAN
06-0377
 - **06-0379**

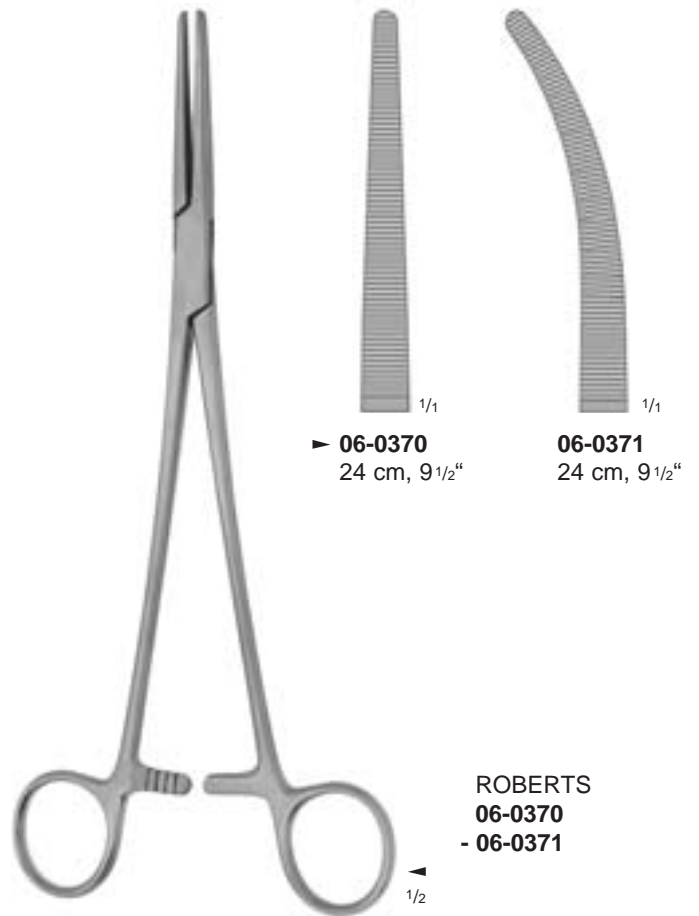

► **06-0370**
24 cm, 9 1/2"

06-0371
24 cm, 9 1/2"

ROBERTS
06-0370
 - **06-0371**

Arterien- und Tonsillenklammen

Haemostatic and Tonsil Forceps

Pinzas hemostáticas y para amígdalas

Pinces hémostatiques et pour amygdales

Pinze emostatiche e per tonsille

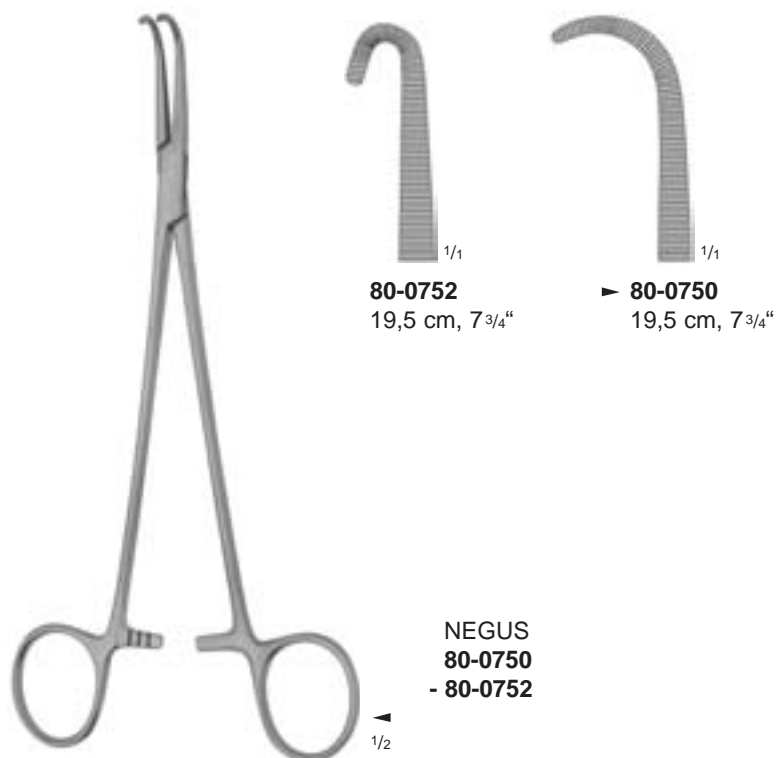
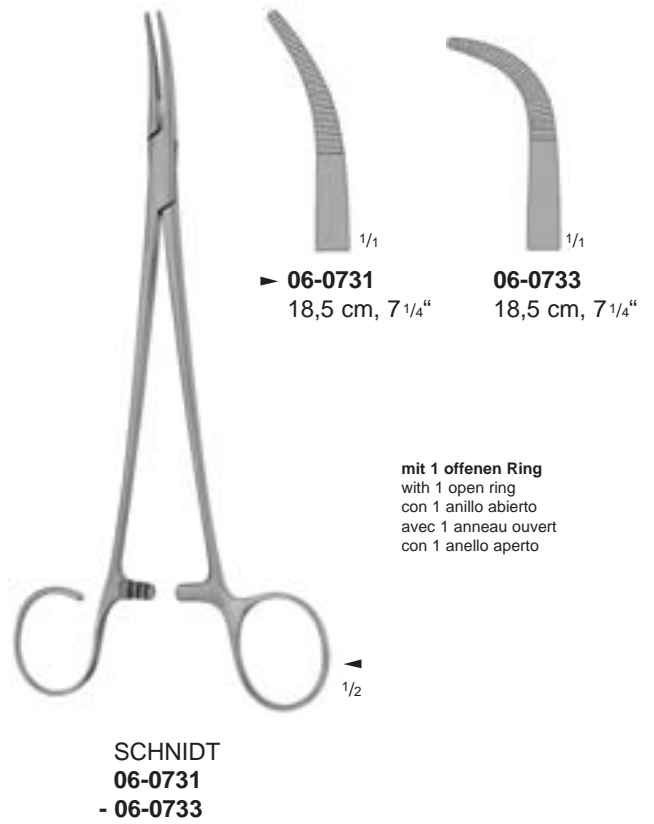
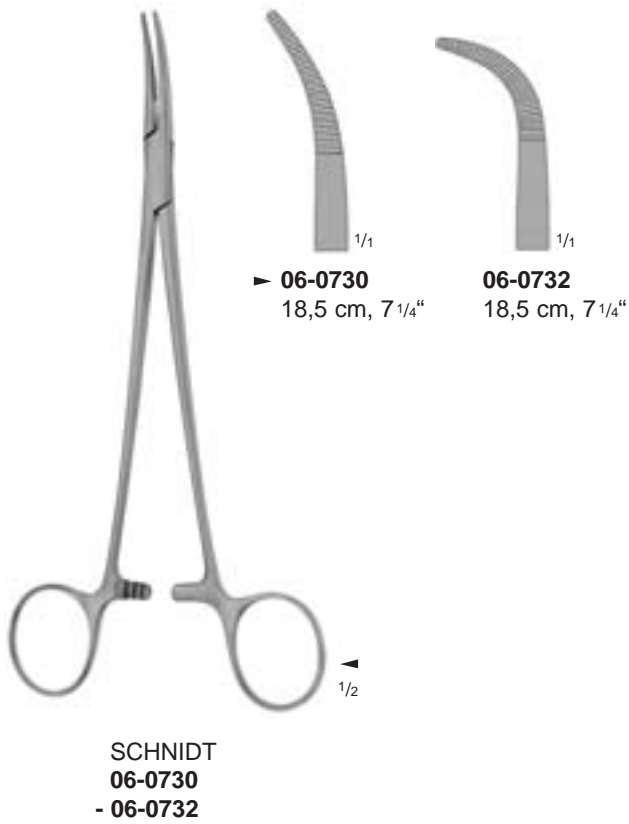



Präparier- und Ligaturklemmen

Dissecting and Ligature Forceps

Pinzas de disección y ligaduras

Pinces à disséquer et à ligatures

Pinze per preparazioni e legature



BABY-ADSON
06-0700
13 cm, 5 1/8"

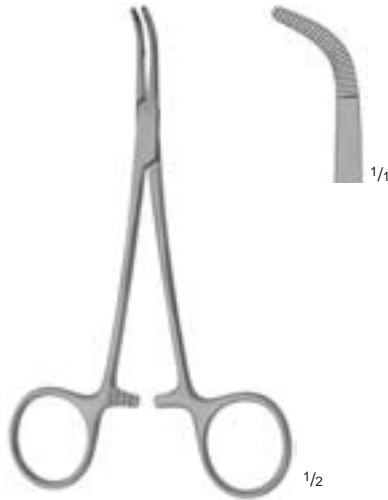

BABY-MIXTER
06-0706
13 cm, 5 1/8"

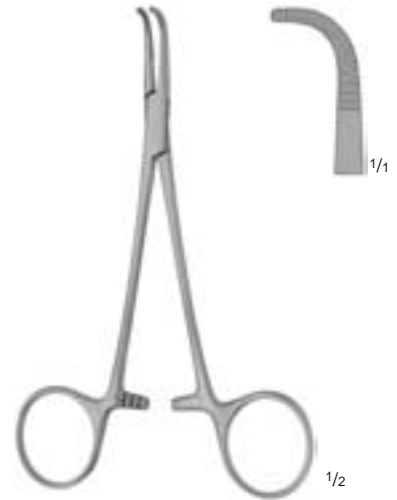

BABY-MEEKER
06-0701
13 cm, 5 1/8"



BABY-ADSON
06-0707
18 cm, 7"



BABY-MIXTER
06-0702
18 cm, 7"



BABY-MEEKER
06-0703
18 cm, 7"

Präparier- und Ligaturklemmen

Dissecting and Ligature Forceps

Pinzas de disección y ligaduras

Pinces à disséquer et à ligatures

Pinze per preparazioni e legature



GEMINI
06-0763
- 06-0766



► 06-0763
18,5 cm, 7 1/4"



06-0764
22,5 cm, 9"



06-0765
24,5 cm, 9 3/4"

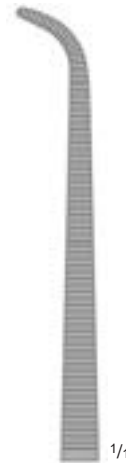

06-0766
28,5 cm, 11 1/4"



GEMINI-MIXTER
06-0767
- 06-0773



06-0767
14 cm, 5 1/2"



06-0768
16 cm, 6 1/4"



► 06-0769
18,5 cm, 7 1/4"

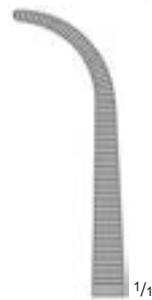

06-0770
20,5 cm, 8"



06-0771
23 cm, 9"

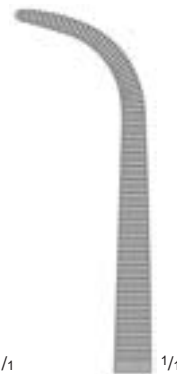

06-0772
25 cm, 10"

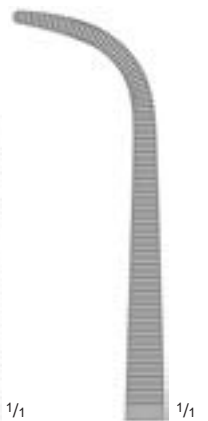

06-0773
28 cm, 11"



Präparier- und Ligaturklemmen

Dissecting and Ligature Forceps

Pinzas de disección y ligaduras

Pinces à disséquer et à ligatures

Pinze per preparazioni e legature

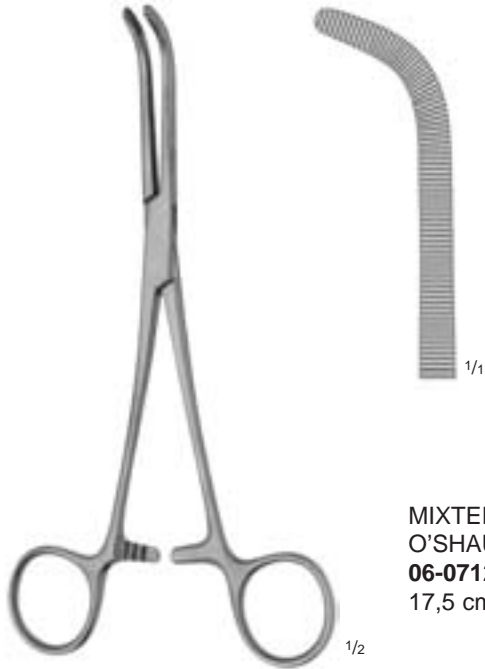

MIXTER-
O'SHAUGHNESSY
06-0712
17,5 cm, 7"

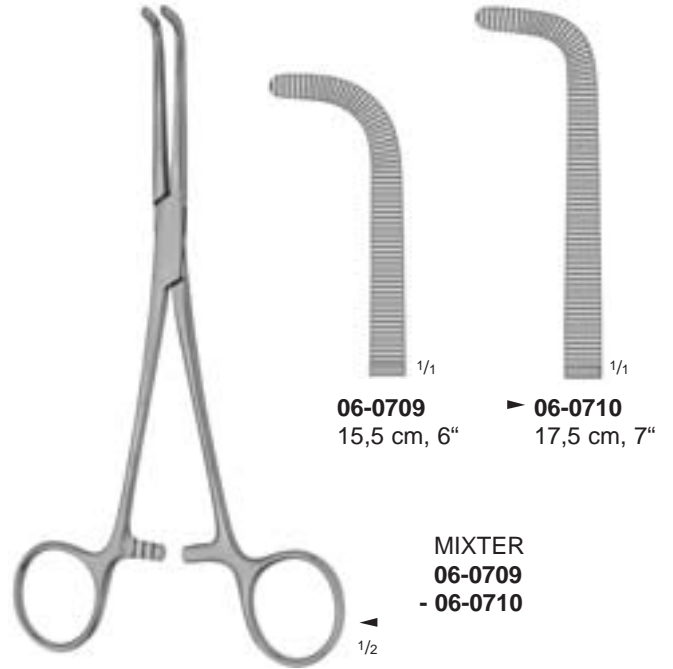

06-0709
15,5 cm, 6"

▶ **06-0710**
17,5 cm, 7"

MIXTER
06-0709
- **06-0710**



MIXTER-PAUL
(HEISS)
06-0711
20 cm, 8"

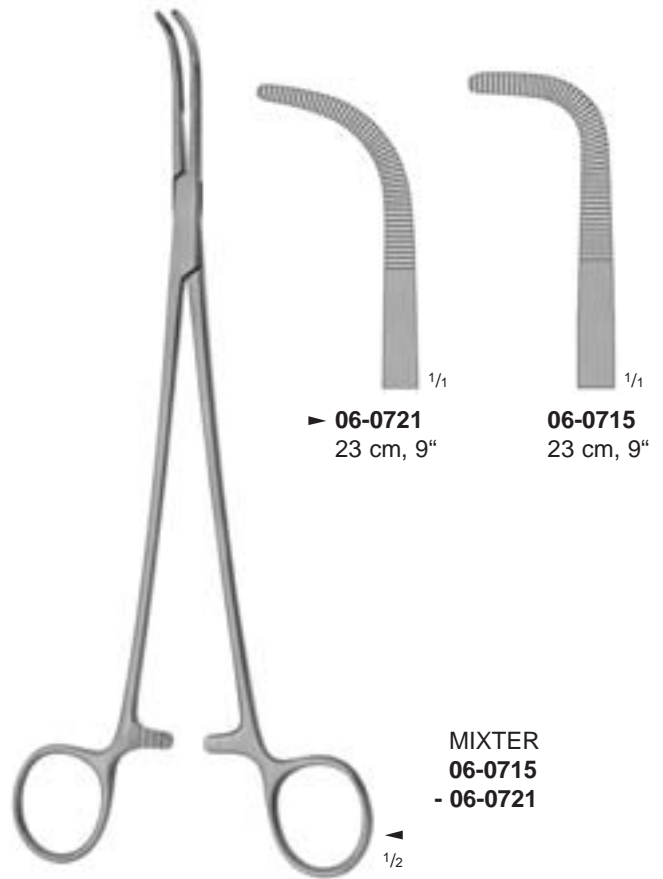

▶ **06-0721**
23 cm, 9"

06-0715
23 cm, 9"

MIXTER
06-0715
- **06-0721**

Präparier- und Ligaturklemmen

Dissecting and Ligature Forceps

Pinzas de disección y ligaduras

Pinces à disséquer et à ligatures

Pinze per preparazioni e legature



BABY-OVERHOLT
06-0705
13,5 cm, 5 1/4"

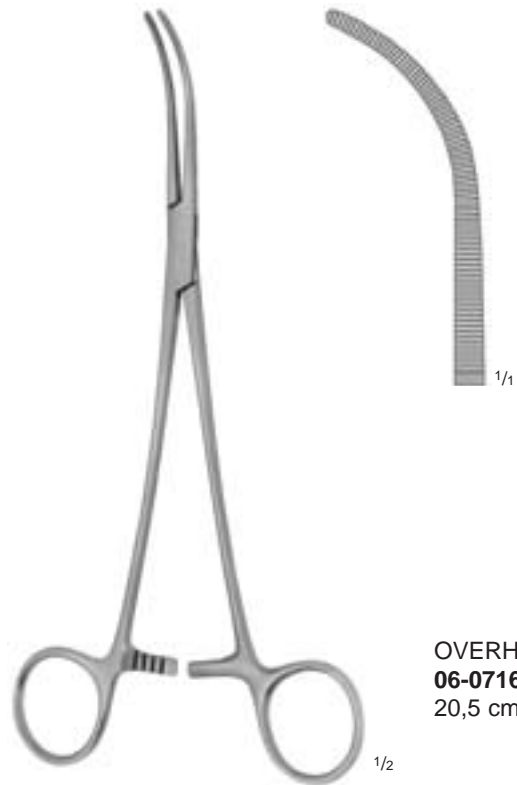

OVERHOLT-MIXTER
06-0716
20,5 cm, 8"

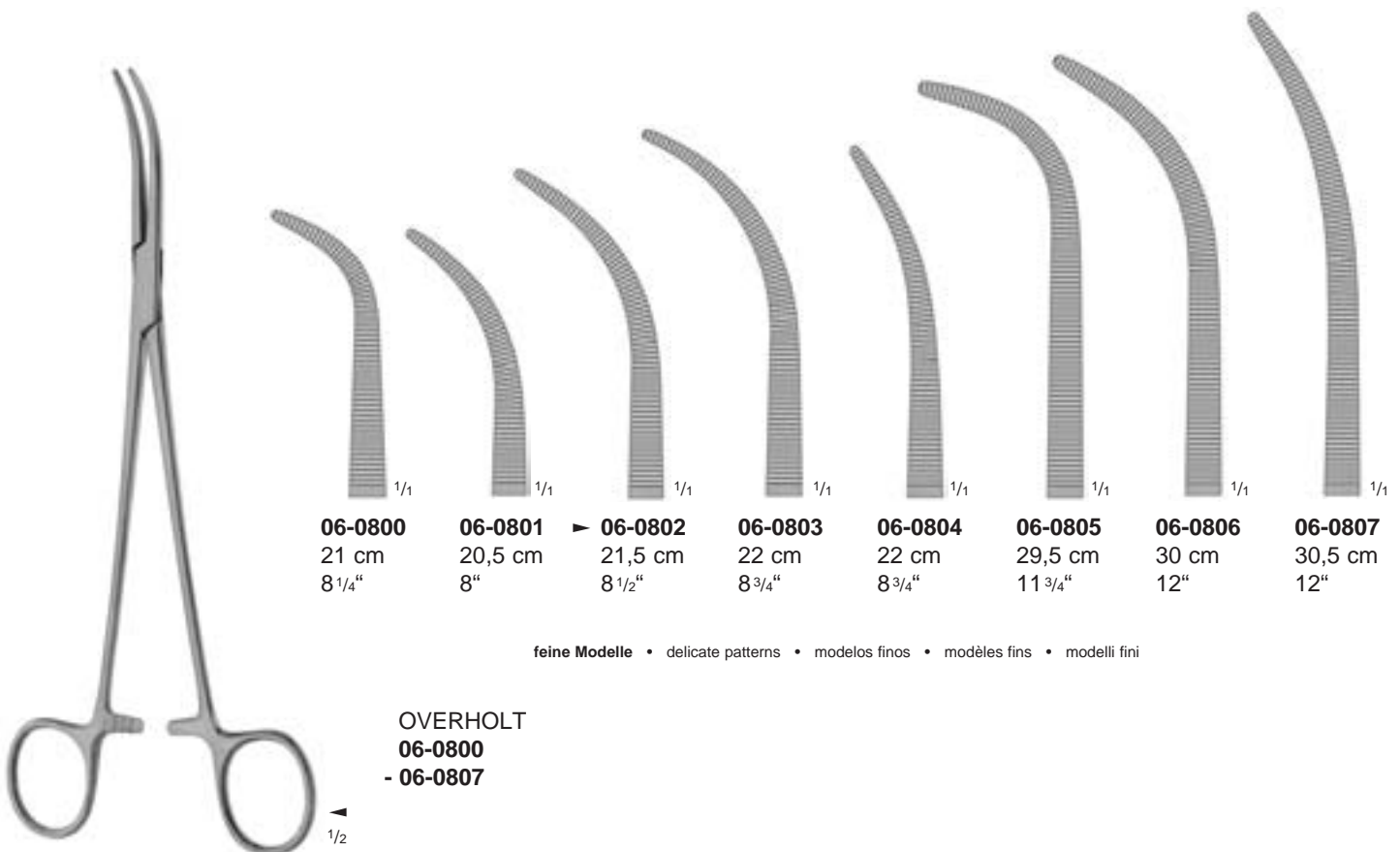

06-0800
21 cm
8 1/4"

06-0801
20,5 cm
8"

06-0802
21,5 cm
8 1/2"

06-0803
22 cm
8 3/4"

06-0804
22 cm
8 3/4"

06-0805
29,5 cm
11 3/4"

06-0806
30 cm
12"

06-0807
30,5 cm
12"

feine Modelle • delicate patterns • modelos finos • modèles fins • modelli fini

OVERHOLT
06-0800
- 06-0807



Präparier- und Ligaturklemmen







Dissecting and Ligature Forceps

Pinzas de disección y ligaduras

Pinces à disséquer et à ligatures

Pinze per preparazioni e legature



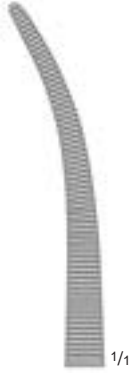



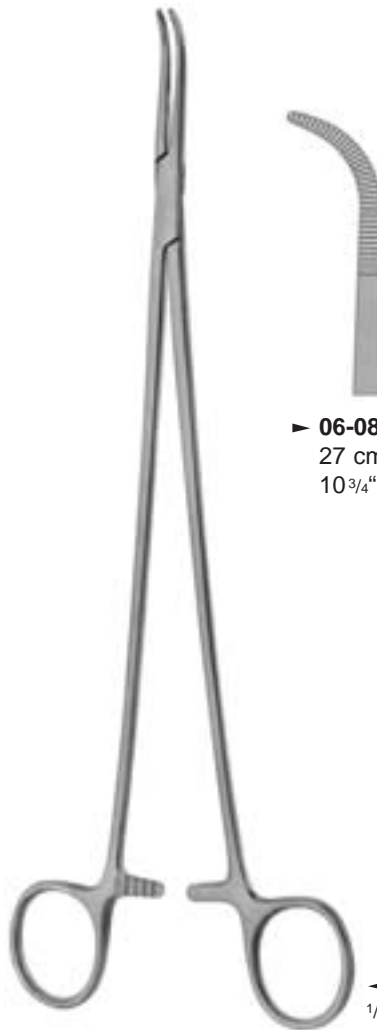

| | | | | | | |
|---|---|---|---|--|---|---|
|  |  |  |  |  |  |  |
| 1/1 | 1/1 | 1/1 | 1/1 | 1/1 | 1/1 | 1/1 |
| ► 06-0740 19,5 cm 7 3/4" | 06-0741 19 cm 7 1/2" | 06-0742 21 cm 8 1/4" | 06-0743 22 cm 8 3/4" | 06-0744 21,5 cm 8 1/2" | 06-0745 22 cm 8 3/4" | 06-0746 22 cm 8 3/4" |

OVERHOLT-GEISSENDOERFER
06-0740
 - **06-0746**

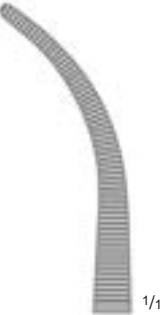
1/2



| | | | | | | |
|---|---|---|---|--|---|---|
|  |  |  |  |  |  |  |
| 1/1 | 1/1 | 1/1 | 1/1 | 1/1 | 1/1 | 1/1 |
| ► 06-0820 27 cm 10 3/4" | 06-0821 26 cm 10 1/4" | 06-0822 27 cm 10 3/4" | 06-0823 27,5 cm 10 3/4" | 06-0824 27 cm 10 3/4" | 06-0825 28 cm 11" | 06-0826 28 cm 11" |

OVERHOLT-GEISSENDOERFER
06-0820
 - **06-0826**

1/2

Präparier- und Ligaturklemmen

Dissecting and Ligature Forceps

Pinzas de disección y ligaduras

Pinces à disséquer et à ligatures

Pinze per preparazioni e legature

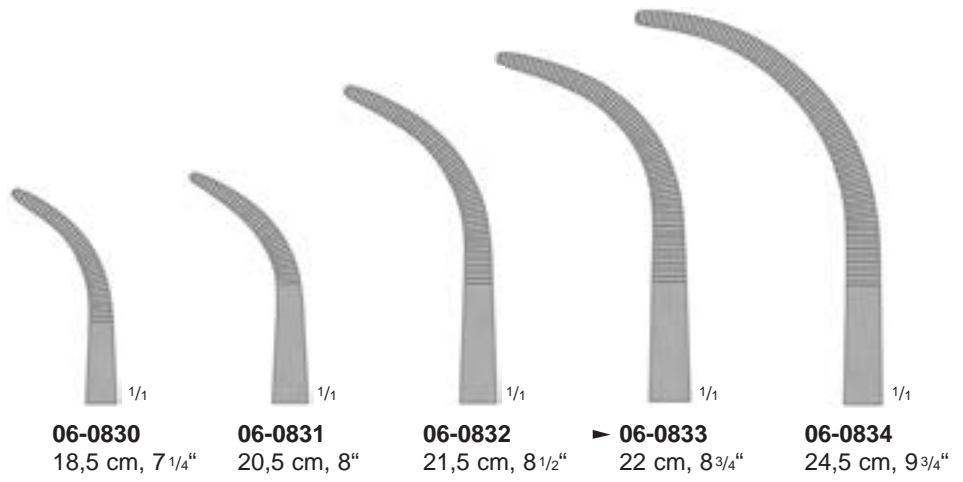

OVERHOLT
06-0830
- 06-0834

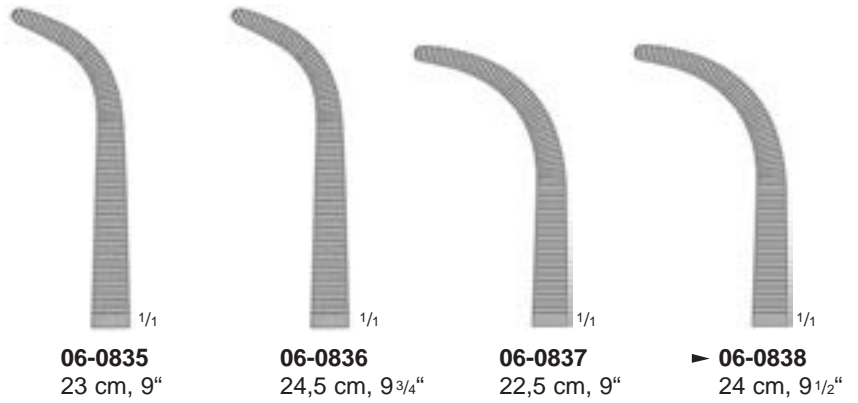

OVERHOLT-MIOTTI
06-0835
- 06-0838



Präparier- und Ligaturklemmen

Dissecting and Ligature Forceps

Pinzas de disección y ligaduras

Pinces à disséquer et à ligatures

Pinze per preparazioni e legature

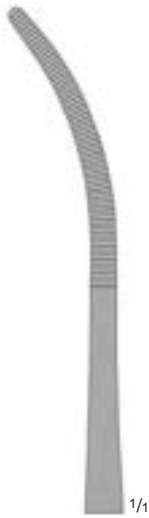

▶ **36-0321**
24,5 cm, 9³/₄"

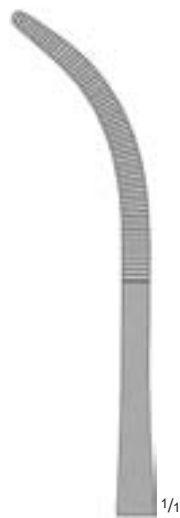

36-0322
24,5 cm, 9³/₄"

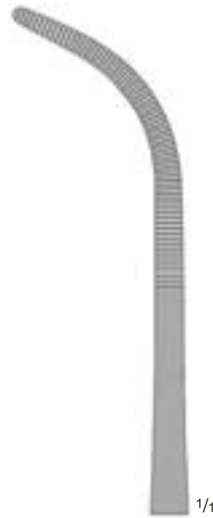

36-0323
24,5 cm, 9³/₄"

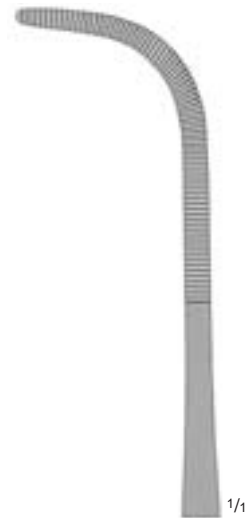

36-0324
24,5 cm, 9³/₄"

RUMEL
36-0321
- **36-0324**

1/2

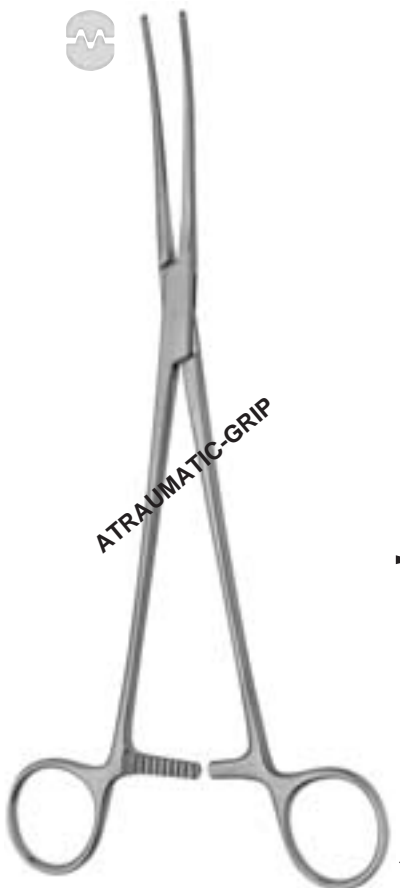

▶ **36-1326**
24,5 cm, 9³/₄"



36-1327
24 cm, 9¹/₂"



36-1328
23,5 cm, 9¹/₄"



36-1329
23 cm, 9"

RUMEL-DE BAKEY
36-1326
- **36-1329**

mit atraumatischer Riefung
with non-traumatic serration
con bocas atraumáticas
avec mors atrauma
con morsi atraumatici

1/2

Präparier- und Ligaturklemmen

Dissecting and Ligature Forceps

Pinzas de disección y ligaduras

Pinces à disséquer et à ligatures

Pinze per preparazioni e legature



BRIDGE
06-0291
28,5 cm, 11 1/4"



LAWRENCE
06-0294
28 cm, 11"



MEEKER
06-0297
28 cm, 11"



Präparier- und Ligaturklemmen

Dissecting and Ligature Forceps

Pinzas de disección y ligaduras

Pinces à disséquer et à ligatures

Pinze per preparazioni e legature



MIXTER
06-0719
28 cm, 11"



► 06-0761
31 cm, 12 1/4"

06-0762
30,5 cm, 12"

Präparier- und Ligaturklemmen

Dissecting and Ligature Forceps

Pinzas de disección y ligaduras

Pinces à disséquer et à ligatures

Pinze per preparazioni e legature



LOWER
11-0420
18,5 cm, 7 1/4"

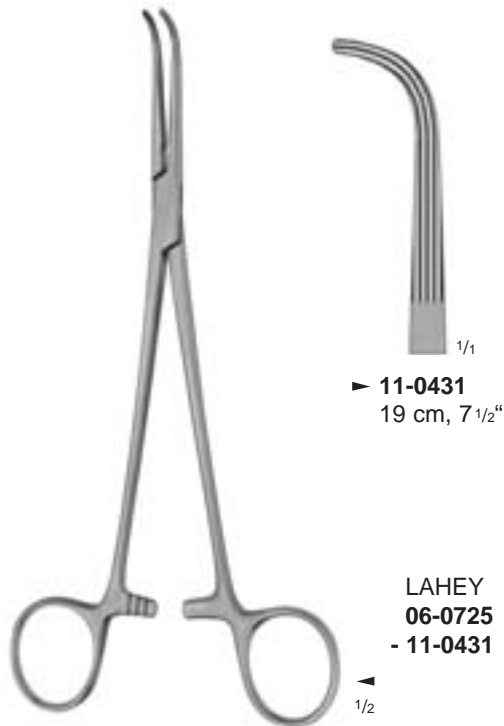

▶ **11-0431**
19 cm, 7 1/2"

06-0725
23 cm, 9"

LAHEY
06-0725
- **11-0431**

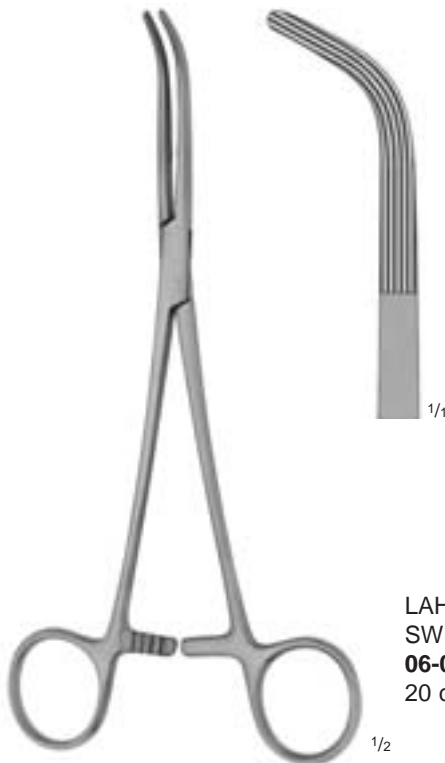

LAHEY-SWEET
06-0723
20 cm, 8"

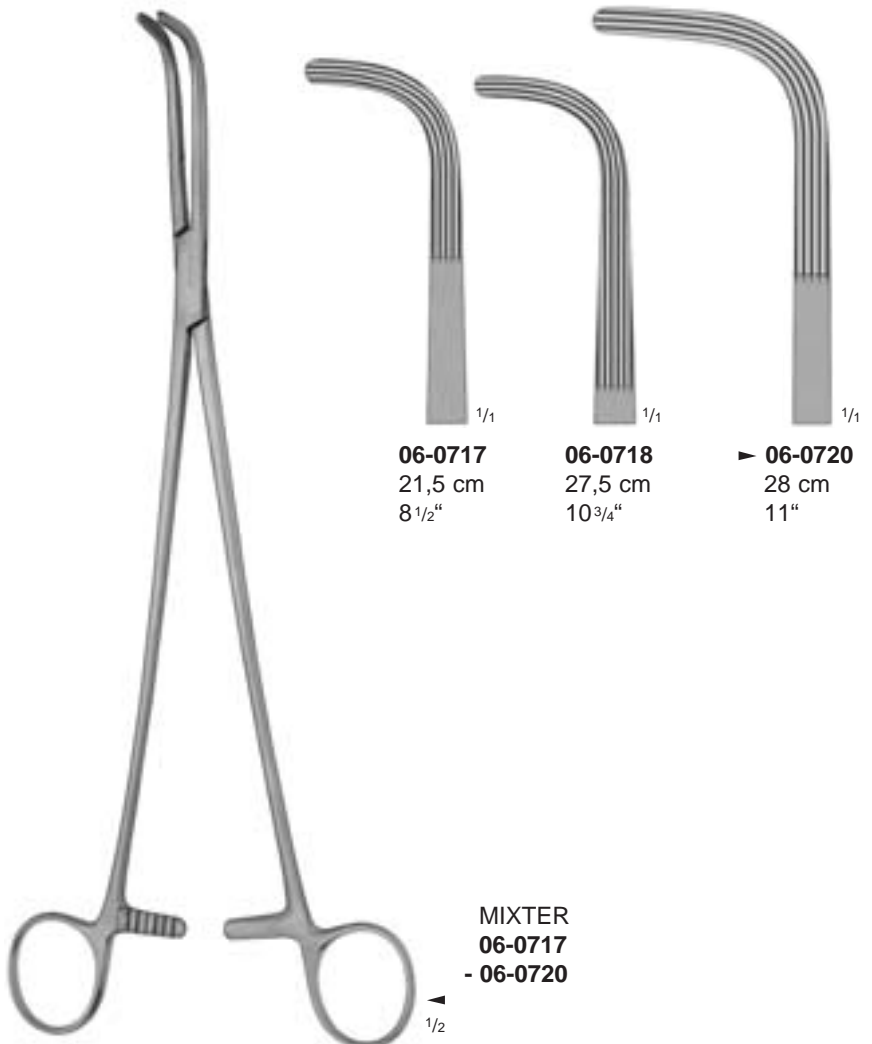

06-0717
21,5 cm
8 1/2"

06-0718
27,5 cm
10 3/4"

▶ **06-0720**
28 cm
11"

MIXTER
06-0717
- **06-0720**



Nierenklemmen

Kidney Clamps
Pinzas-clamps para renal
Clamps rénaux
Pinze-clamps per rene

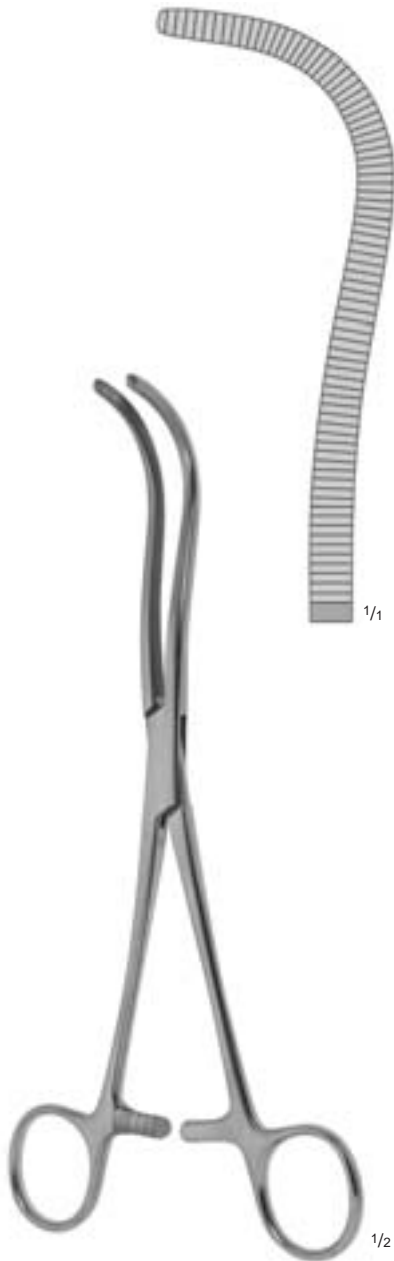

GUYON
92-0550
23,5 cm, 9 1/4"

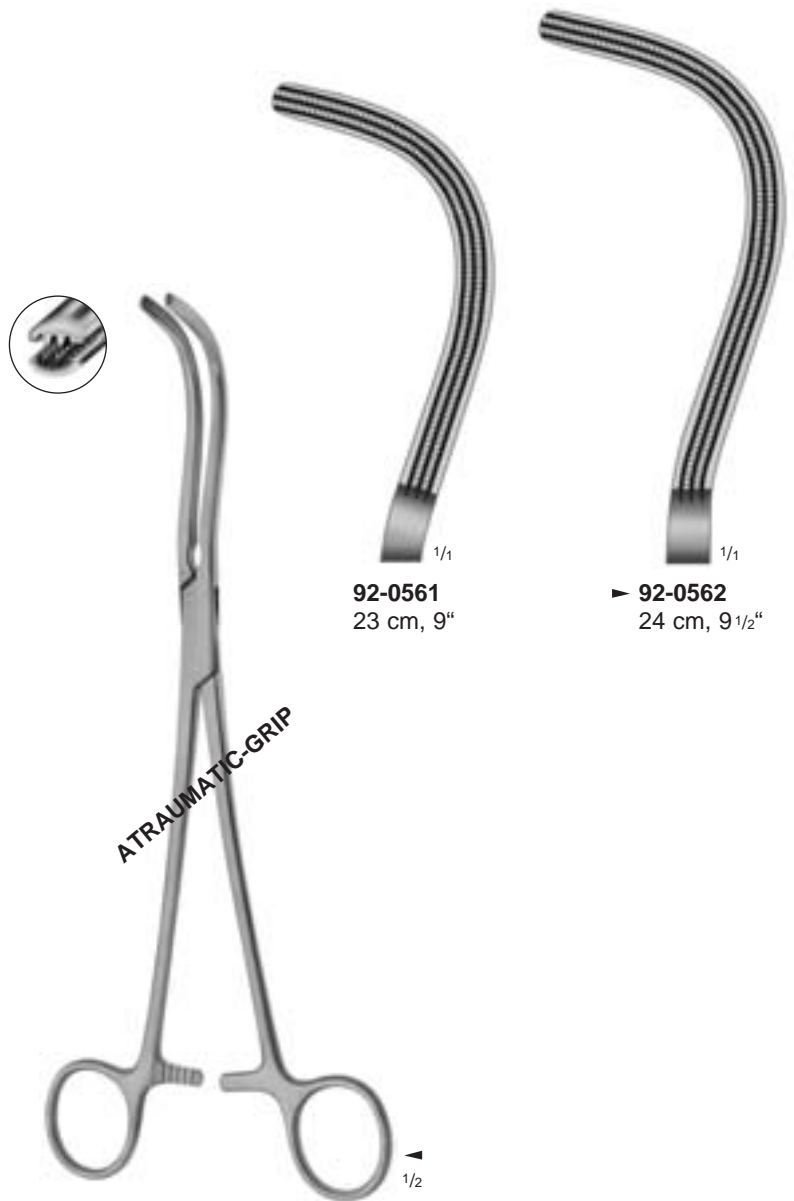

92-0561
23 cm, 9"

▶ 92-0562
24 cm, 9 1/2"

GUYON-DE BAKEY
92-0561
- 92-0562

mit atraumatischer Riefung
with non-traumatic serration
con bocas atraumáticas
avec mors atrauma
con morsi atraumatici

Nierenstielklemmen

Kidney Pedicle Clamps

Pinzas-clamps para pedúnculo renal

Pinces-clamps pour pédicules rénaux

Pinze per peduncoli renali



HERRICK
92-0560
23,5 cm, 9 1/4"



WERTHEIM-CULLEN
92-0580
23 cm, 9"



Peritoneumklemmen

Peritoneum Forceps

Pinzas-clamps para peritoneo

Pinces-clamps pour le péritoine

Pinze per peritoneo

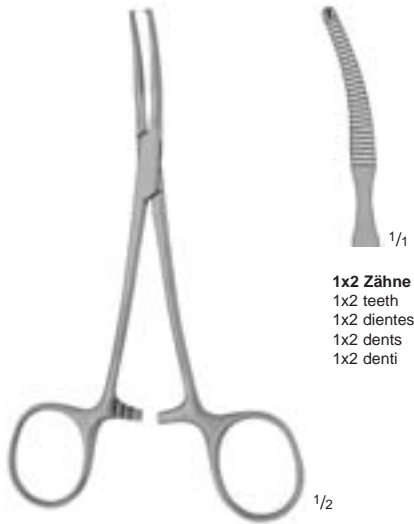

1x2 Zähne
1x2 teeth
1x2 dientes
1x2 dents
1x2 denti

BABY-MIKULICZ
92-0612
14 cm, 5 1/2"

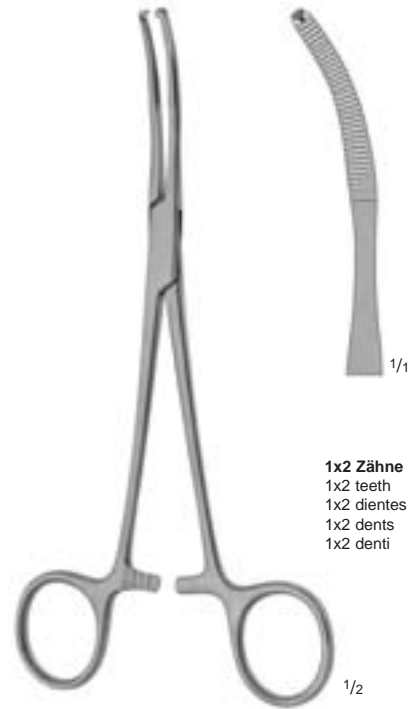

1x2 Zähne
1x2 teeth
1x2 dientes
1x2 dents
1x2 denti

MIKULICZ
92-0613
18,5 cm, 7 1/4"

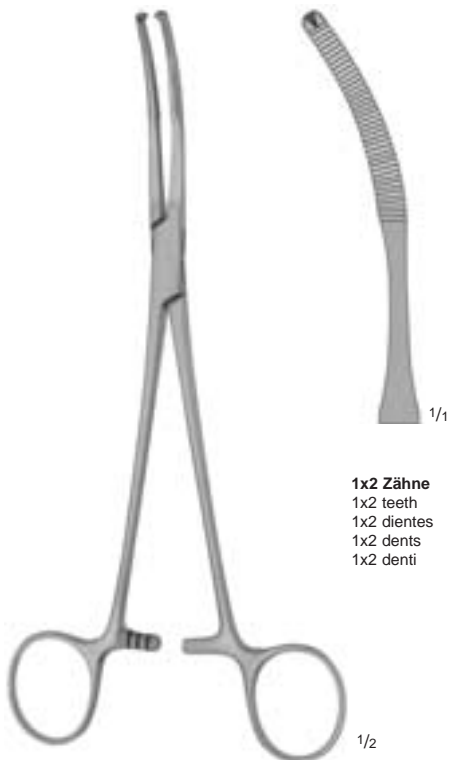

1x2 Zähne
1x2 teeth
1x2 dientes
1x2 dents
1x2 denti

MIKULICZ
92-0625
20 cm, 8"

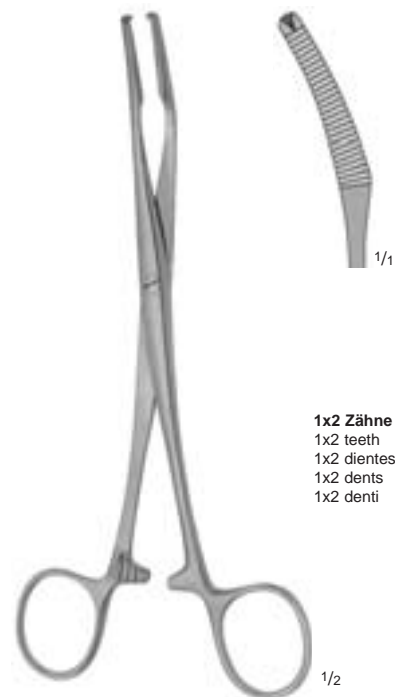

1x2 Zähne
1x2 teeth
1x2 dientes
1x2 dents
1x2 denti

MIKULICZ
92-0615
18 cm, 7"

Peritoneumklemmen

Peritoneum Forceps

Pinzas-clamps para peritoneo

Pinces-clamps pour le péritoine

Pinze per peritoneo

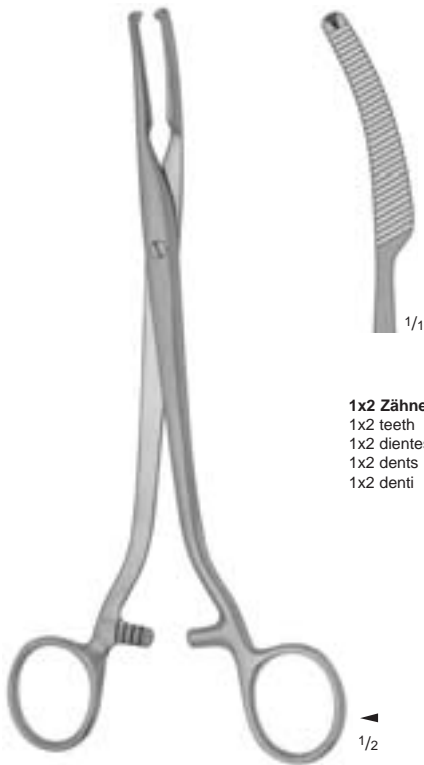

1x2 Zähne
1x2 teeth
1x2 dientes
1x2 dents
1x2 denti

MIKULICZ
92-0620
20 cm, 8"

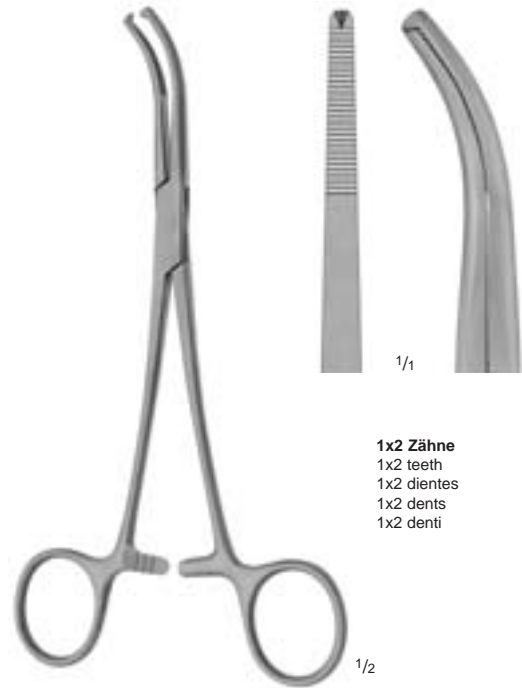

1x2 Zähne
1x2 teeth
1x2 dientes
1x2 dents
1x2 denti

MIKULICZ
92-0624
18,5 cm, 7 1/4"

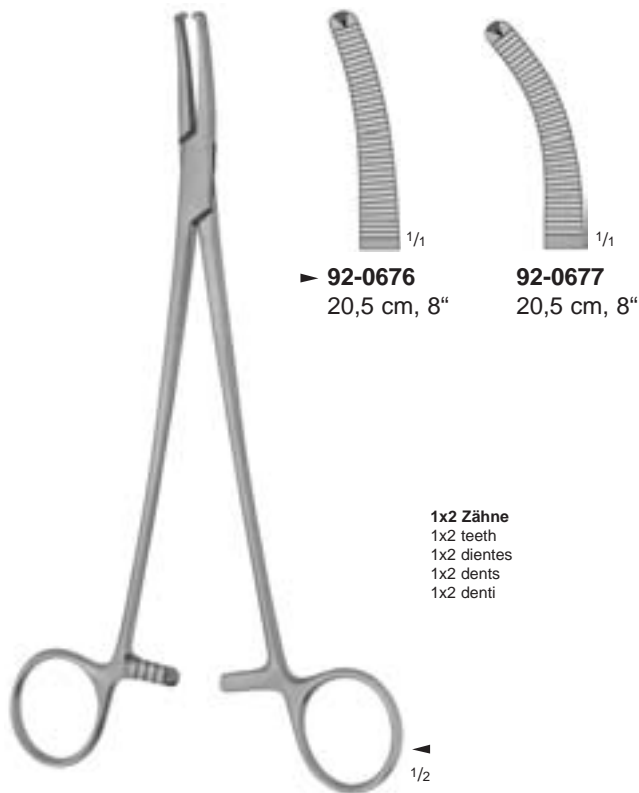

► 92-0676
20,5 cm, 8"

92-0677
20,5 cm, 8"

1x2 Zähne
1x2 teeth
1x2 dientes
1x2 dents
1x2 denti

FAURE
92-0676
- 92-0677

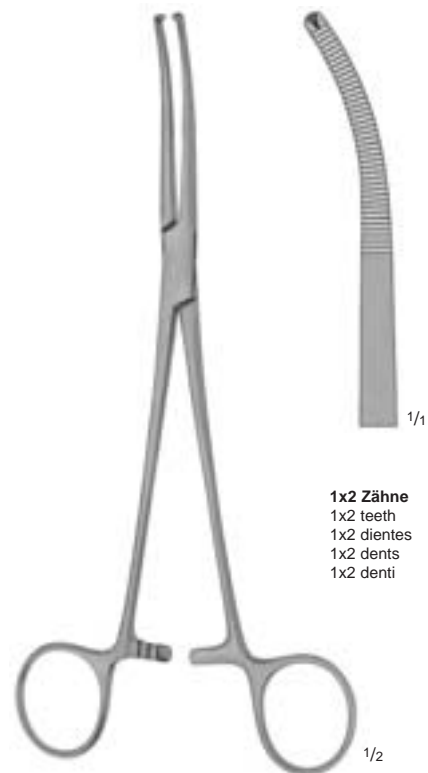

1x2 Zähne
1x2 teeth
1x2 dientes
1x2 dents
1x2 denti

MIKULICZ
80-0735
20 cm, 8"



Hysterektomieklemmen

Hysterectomy Forceps
Pinzas-clamps para histerectomía
Pincès à hystérectomie
Pinze per isterectomia

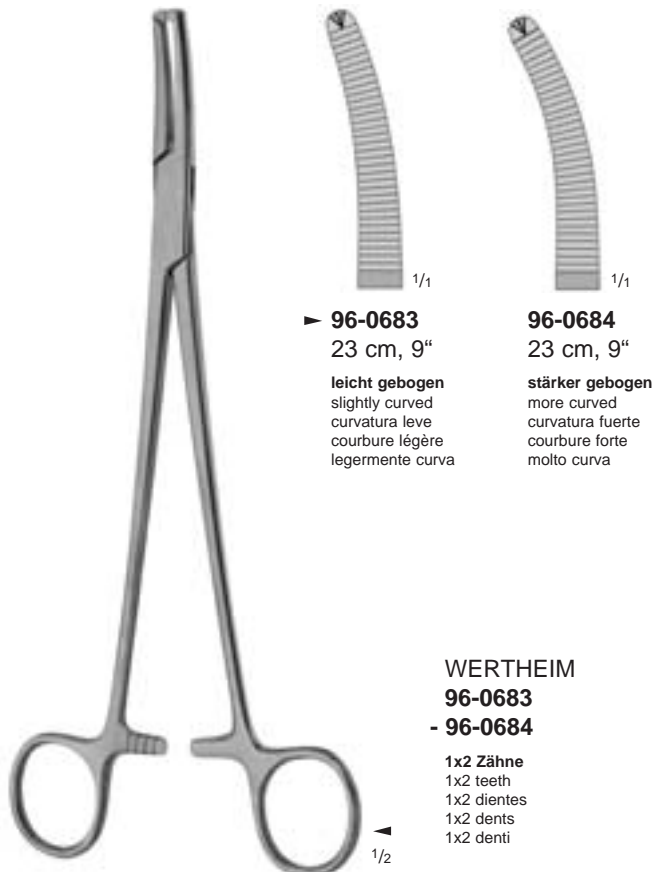
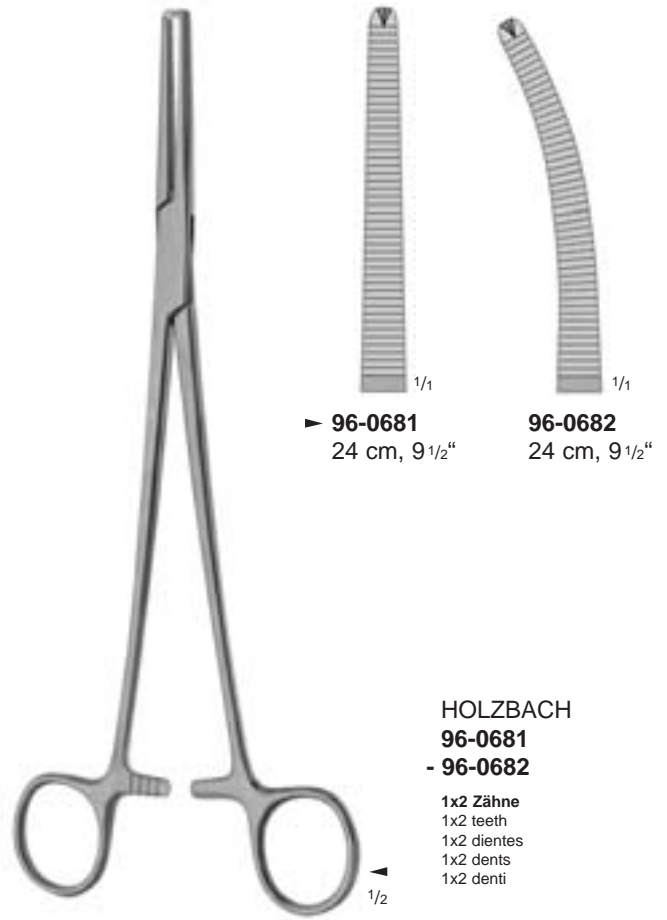
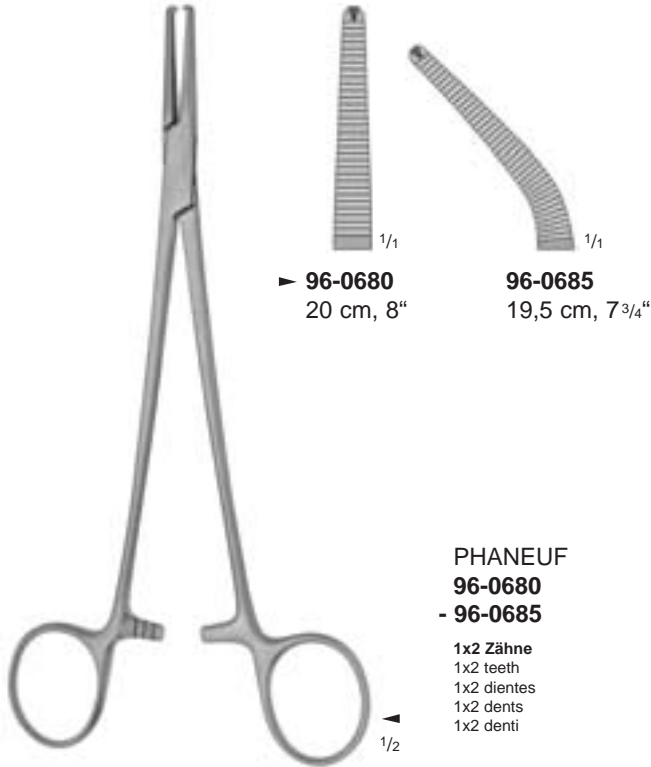

Hysterektomieklemmen

Hysterectomy Forceps

Pinzas-clamps para histerectomía

Pinces à hystérectomie

Pinze per isterectomia



WERTHEIM
92-0590
25 cm, 10"



WERTHEIM
96-0605
25,5 cm, 10"

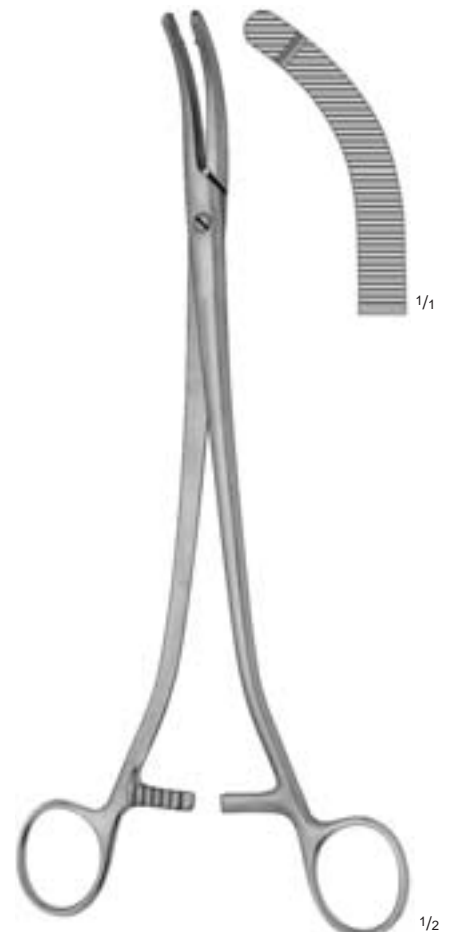

SEGOND
96-0674
24,5 cm, 9³/₄"



Hysterektomieklemmen

Hysterectomy Forceps

Pinzas-clamps para histerectomía

Pinces à hystérectomie

Pinze per isterectomia

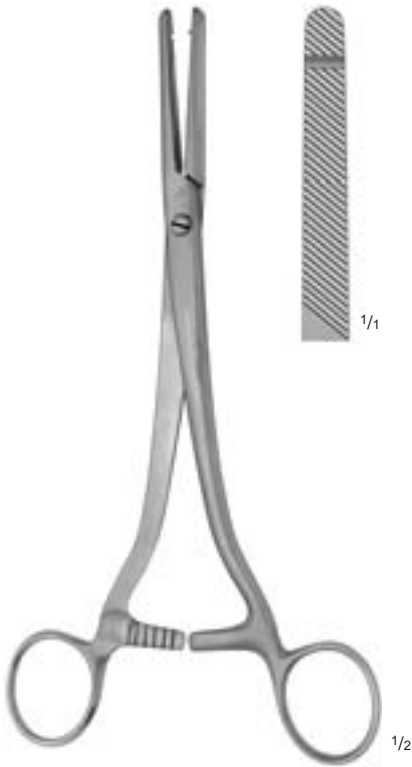

SEGOND
96-0670
20 cm, 8"



HEANEY
96-0600
21 cm, 8 1/4"

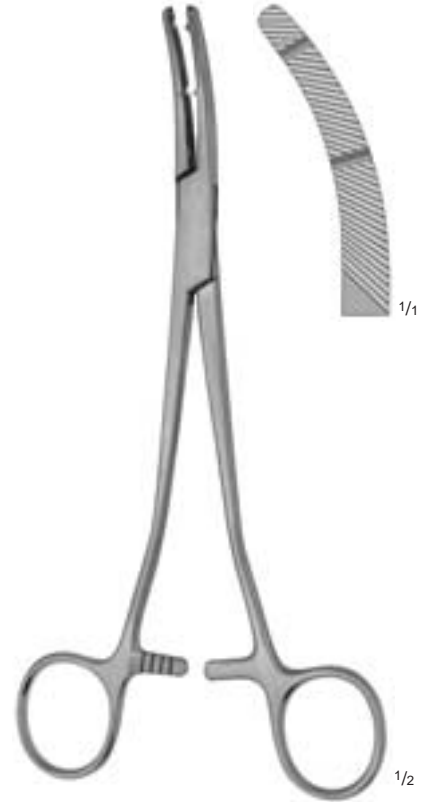

HEANEY
96-0602
21 cm, 8 1/4"

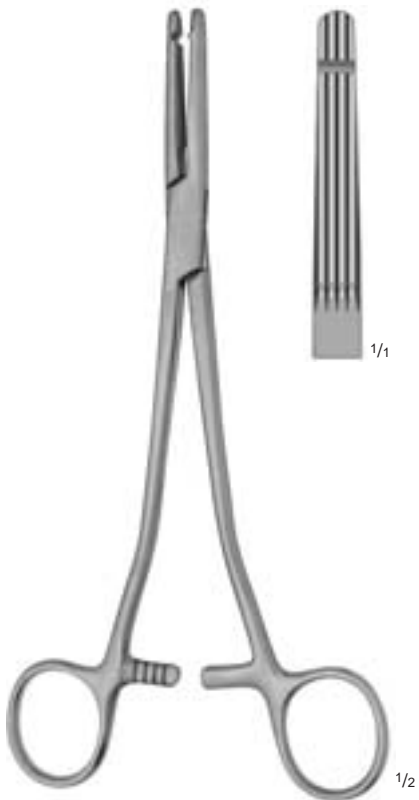

BALLENTINE
96-0630
21,5 cm, 8 1/2"



HEANEY-BALLENTINE
96-0628
21,5 cm, 8 1/2"

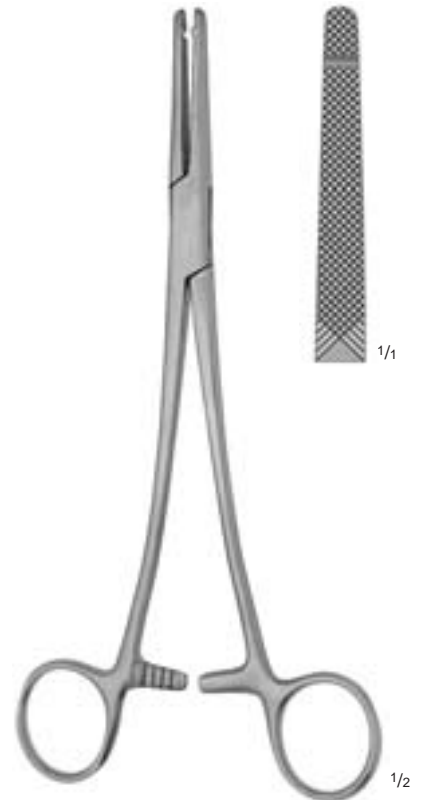

HEANEY-REZEK
96-0625
21,5 cm, 8 1/2"

ATRAUMATIC-GRIP Hysterektomieklemmen mit atraumatischer Riefung
ATRAUMATIC-GRIP Hysterectomy Forceps with non-traumatic serration
ATRAUMATIC-GRIP Pinzas-clamps para histerectomía con bocas atraumáticas
ATRAUMATIC-GRIP Pinces à hystérectomie avec mors atrauma
ATRAUMATIC-GRIP Pinze per isterectomia con morsi atraumatici



HEANEY-DE BAKEY (ROGERS)
96-0580
- 96-0584

1/2

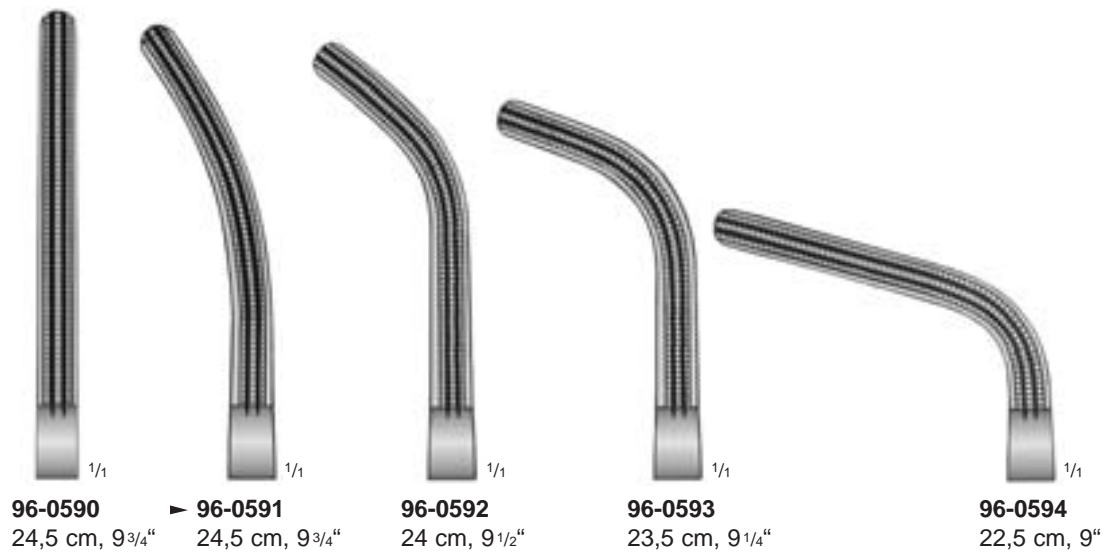

WERTHEIM-DE BAKEY (ROGERS)
96-0590
- 96-0594

Parametriumklemmen
 Parametrium forceps
 Pinzas-clamps parametrium
 Pinces-clamps pour ligaments larges
 Pinze-clamps per parametrio

1/2

**Weitere Klemmen und Klemmzangen**

Further Forceps and Clamps

Más pinzas y pinzas-clamps

D'autres pincés et pincés-clamps

Altre pinze e pinze emostatiche



| | | |
|--|--------------|----------------|
| Polypen- und Ovarienzangen | Seite | 23, 457 |
| Polypus and Ovum Forceps | Page | 23, 457 |
| Pinzas para pólipos uterinos y ovarios | Página | 23, 457 |
| Pincés à polypes et ovaires | Page | 23, 457 |
| Pinze per polipi e ovaie | Pagina | 23, 457 |



| | | |
|--|--------------|------------------|
| Darm- und Gewebefazangen | Seite | 383 - 389 |
| Intestinal and Tissue Grasping Forceps | Page | 383 - 389 |
| Pinzas intestinales y para tejidos | Página | 383 - 389 |
| Pincés pour l'intestin et tissu | Page | 383 - 389 |
| Pinze intestinali e da presa | Pagina | 383 - 389 |



| | | |
|-------------------------------------|--------------|------------------|
| Darmklemmen | Seite | 390 - 403 |
| Intestinal Clamps Forceps | Page | 390 - 403 |
| Pinzas-clamps intestinales | Página | 390 - 403 |
| Pincés-clamps pour l'intestin | Page | 390 - 403 |
| Pinze intestinali | Pagina | 390 - 403 |



| | | |
|--|--------------|-----------------------------|
| ATRAUMATIC-GRIP Gefäßklemmen | Seite | 519 - 524, 529 - 562 |
| ATRAUMATIC-GRIP Vascular Clamps | Page | 519 - 524, 529 - 562 |
| ATRAUMATIC-GRIP Pinzas-clamps vasculares | Página | 519 - 524, 529 - 562 |
| ATRAUMATIC-GRIP Pincés vasculaires | Page | 514 - 524, 529 - 562 |
| ATRAUMATIC-GRIP Pinze vascolari | Pagina | 519 - 524, 529 - 562 |



| | | |
|---|--------------|------------------|
| ATRAUMATIC-GRIP Bulldogklemmen | Seite | 525 - 528 |
| ATRAUMATIC-GRIP Bulldog Clamps | Page | 525 - 528 |
| ATRAUMATIC-GRIP Clamps Bulldog | Página | 525 - 528 |
| ATRAUMATIC-GRIP Clamps Bulldog | Page | 525 - 528 |
| ATRAUMATIC-GRIP Pinze Bulldog | Pagina | 525 - 528 |



| | | |
|--------------------------------|--------------|------------------|
| Gefäßklemmen | Seite | 563 - 565 |
| Vascular Clamps | Page | 563 - 565 |
| Pinzas-clamps vasculares | Página | 563 - 565 |
| Pincés vasculaires | Page | 563 - 565 |
| Pinze vascolari | Pagina | 563 - 565 |



| | | |
|---------------------------------|--------------|------------|
| Bronchusklemmen | Seite | 566 |
| Bronchus Forceps | Page | 566 |
| Pinzas-clamps bronquiales | Página | 566 |
| Pincés-clamps à bronches | Page | 566 |
| Pinze per legature | Pagina | 566 |



LAWNTON

Medizintechnik



Tuchklemmen, Schlauchklemmen, Tupferzangen

Towel Clamps, Tubing Clamps, Cotton Swab Forceps

Pinzas de campo, Pinzas para tubos, Pinzas para tampones

Pinces à compresses, Pinces presse-tubes, Pinces à tampons

Pinze per fissare le compresse, Pinze per tubi, Pinze per tamponi



Tuchklemmen
Towel Clamps
Pinzas de campo
Pinces à compresses
Pinze per fissare le compresse



JONES
07-0135
6 cm, 2 3/8"



JONES
07-0130
8,5 cm, 3 3/8"



ENGL. MOD.
07-0138
8,5 cm, 3 3/8"



SCHÄDEL
07-0139
9 cm, 3 1/2"



SCHÄDEL
07-0140
9 cm, 3 1/2"



DOYEN
07-0143
18 cm, 7"



JONES
07-0131
8,5 cm, 3 3/8"
mit Schlauch- oder Kabelhalter
with clip for tubing or cable
con porta-tubo o porta-cable
avec porte-tube ou porte-cordon
d'alimentation
con porta-tubo o porta-cavo



07-0103
11 cm, 4 3/8"
mit Schlauch- oder Kabelhalter
with clip for tubing or cable
con porta-tubo o porta-cable
avec porte-tube ou porte-cordon
d'alimentation
con porta-tubo o porta-cavo



GREEN
07-0111
16,5 cm, 6 1/2"
mit Schlauch- oder Kabelhalter
with clip for tubing or cable
con porta-tubo o porta-cable
avec porte-tube ou porte-cordon
d'alimentation
con porta-tubo o porta-cavo

Tuchklemmen
Towel Clamps
Pinzas de campo
Pincas à compresses
Pinze per fissare le compresse

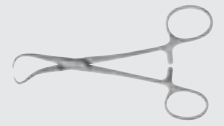

BACKHAUS
07-0100
- 07-0109



07-0100
9 cm, 3 1/2"



07-0102
11 cm, 4 3/8"



▶ 07-0105
13,5 cm, 5 1/4"



07-0109
15,5 cm, 6"



ROEDER
07-0110
13,5 cm, 5 1/4"



BERNHARD
07-0106
16 cm, 6 1/4"



LANE
07-0108
19,5 cm, 7 3/4"

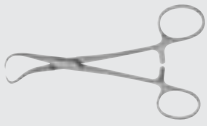

Tuchklemmen
Towel Clamps
Pinzas de campo
Pincas à compresses
Pinze per fissare le compresse

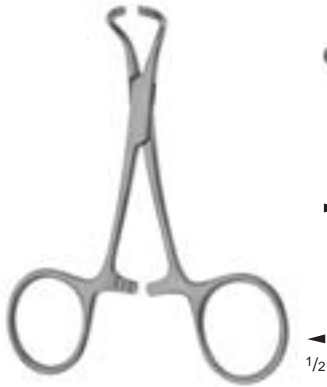

1/2

TOHOKU
07-0126
- 07-0127

für Papiertücher
for paper cloths
para paños de papel
pour champs en papier
per fazzoletti di carta

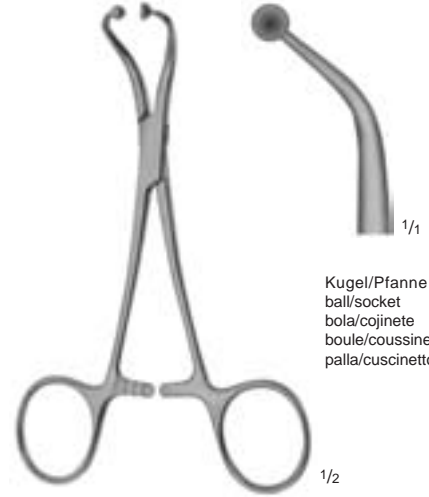

Kugel/Pfanne
ball/socket
bola/cojinete
boule/coussinet
palla/cuscinetto

1/2

07-0120
13,5 cm, 5 1/4"

für Papiertücher
for paper cloths
para paños de papel
pour champs en papier
per fazzoletti di carta

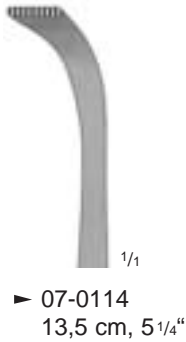
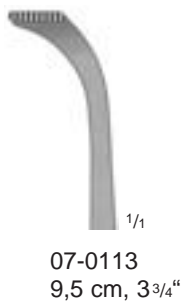

1/2

LORNA
07-0113
- 07-0114

für Papiertücher
for paper cloths
para paños de papel
pour champs en papier
per fazzoletti di carta



PEERS
07-0112
14,5 cm, 5 3/4"

für Papiertücher
for paper cloths
para paños de papel
pour champs en papier
per fazzoletti di carta

Schlauchklemmen
 Tubing Clamps
 Pinzas para tubos
 Pincas presse-tubes
 Pinze per tubi

Schlauchroller
 Tube Milking Roller
 Rodillo para tubos
 Pincas à traire les drains
 Pinza per pressa tubi con rulli

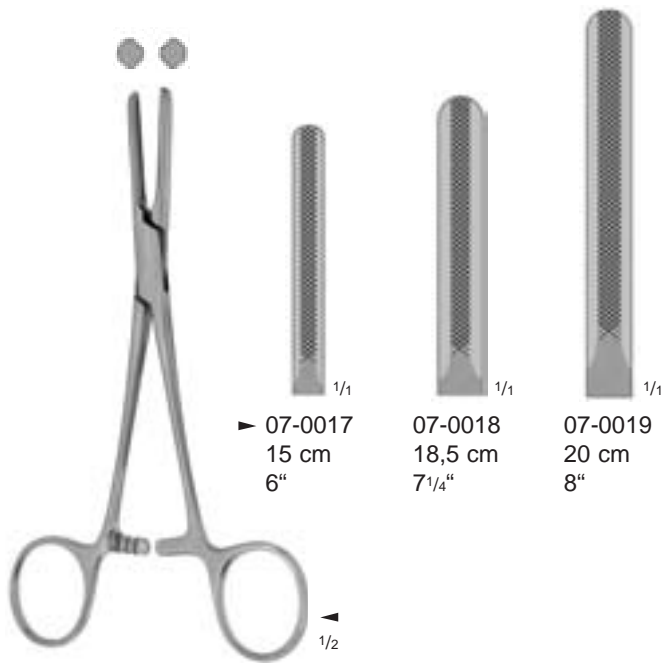

▶ 07-0017
 15 cm
 6"

07-0018
 18,5 cm
 7 1/4"

07-0019
 20 cm
 8"

1/2

07-0017
 - 07-0019

Schlauchklemmen ohne Schutzbügel
 Tubing clamps without safety guard
 Pinzas para tubos, sin estribo de protección
 Pincas presse-tubes sans protection
 Pinze per tubi senza protezione

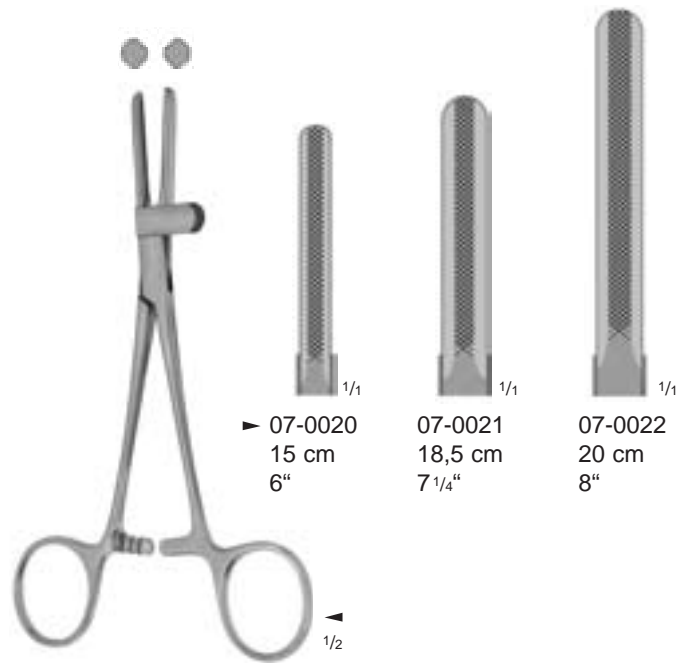

▶ 07-0020
 15 cm
 6"

07-0021
 18,5 cm
 7 1/4"

07-0022
 20 cm
 8"

1/2

07-0020
 - 07-0022

Schlauchklemmen mit Schutzbügel
 Tubing clamps with safety guard
 Pinzas para tubos, con estribo de protección
 Pincas presse-tubes avec protection
 Pinze per tubi con protezione

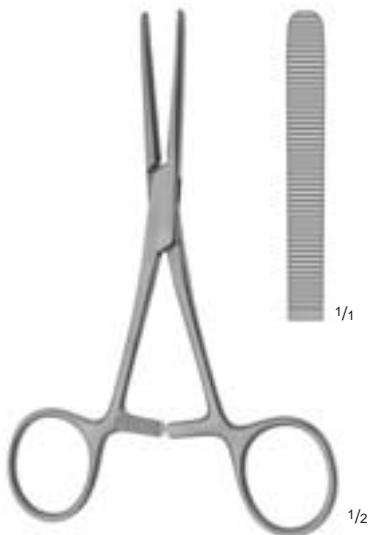

07-0029
 14,5 cm, 5 3/4"

Schlauchklemme
 Tubing clamp
 Pinza para tubos
 Pince presse-tubes
 Pinza per tubi



PRESBYTERIAN
 07-0122
 16,5 cm, 6 1/2"

Schlauchklemme
 Tubing clamp
 Pinza para tubos
 Pince presse-tubes
 Pinza per tubi



GUNNAR-HEY
 07-0030
 18,5 cm, 7 1/4"

Schlauchroller
 Tube milking roller
 Rodillo para tubos
 Pincas à traire les drains
 Pinza pressa tubi con rulli



Korn- und Tupferzangen
 Sponge and Dressing Forceps
 Pinzas para vendajes y torundas
 Pincas à pansements et tampons
 Pinze per medicatura e tamponi



LISTER
 07-0221
 - 07-0227

Sinusklemmen • Sinus forceps • Pinzas para senos • Pincas pour sinus • Pinze per seni

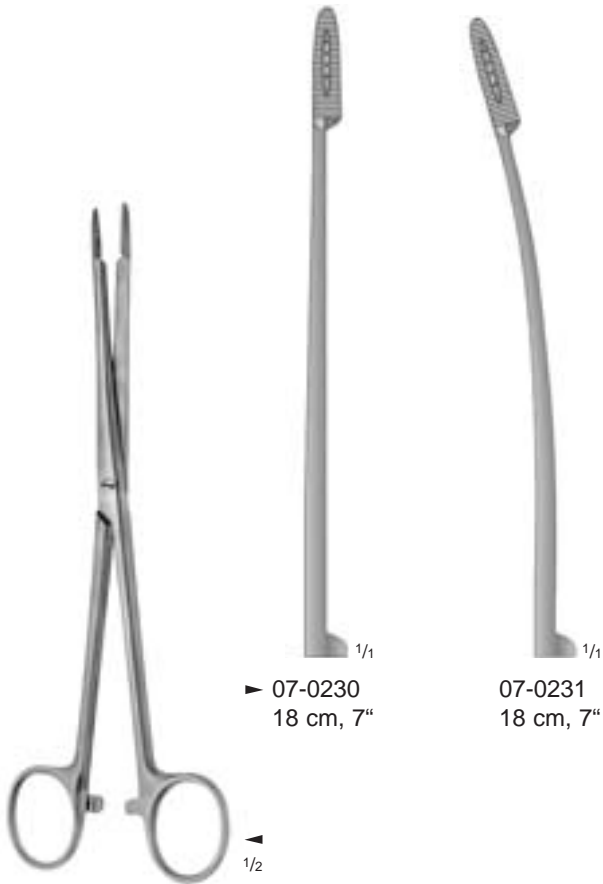

07-0230
 - 07-0231

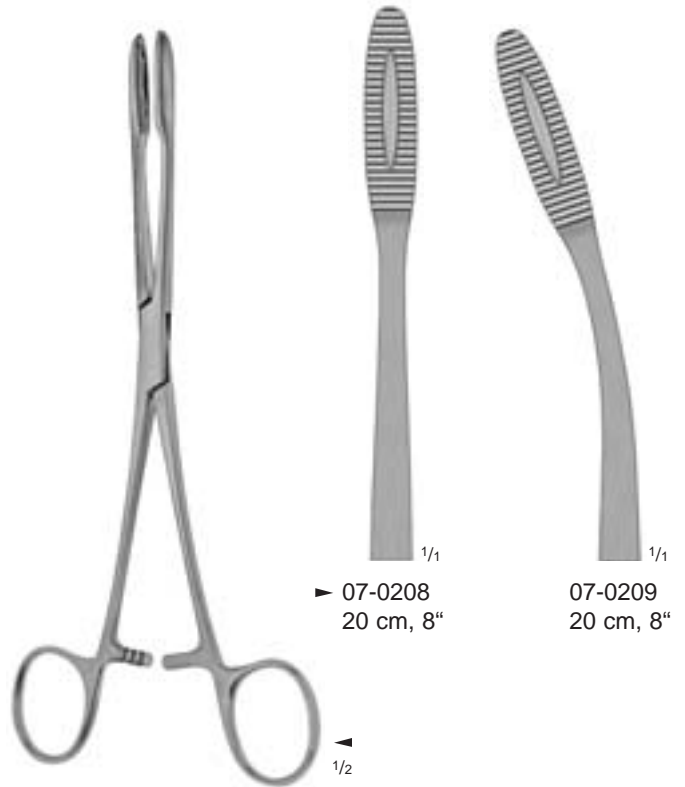

GROSS
 07-0208
 - 07-0209

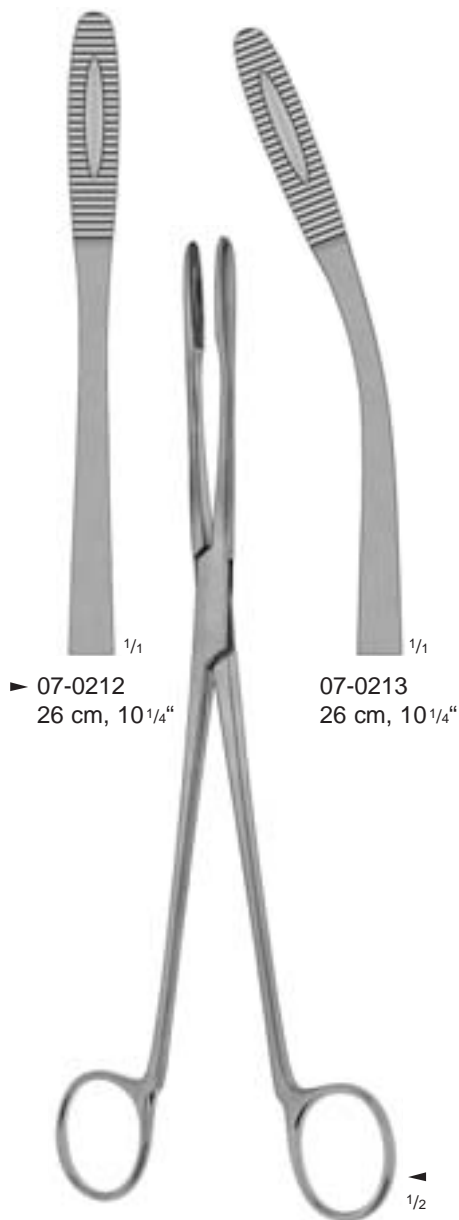

► 07-0212
 26 cm, 10¹/₄"

07-0213
 26 cm, 10¹/₄"

MAIER
 07-0212
 - 07-0213
 ohne Sperre
 without ratchet
 sin cremallera
 sans crémaillère
 senza cremagliera

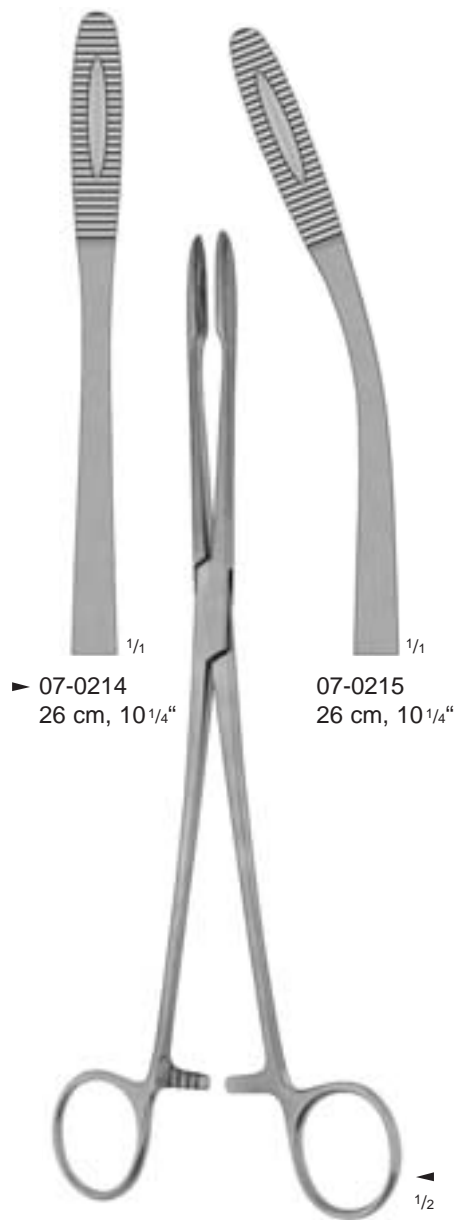

► 07-0214
 26 cm, 10¹/₄"

07-0215
 26 cm, 10¹/₄"

MAIER
 07-0214
 - 07-0215
 mit Sperre
 with ratchet
 con cremallera
 avec crémaillère
 con cremagliera

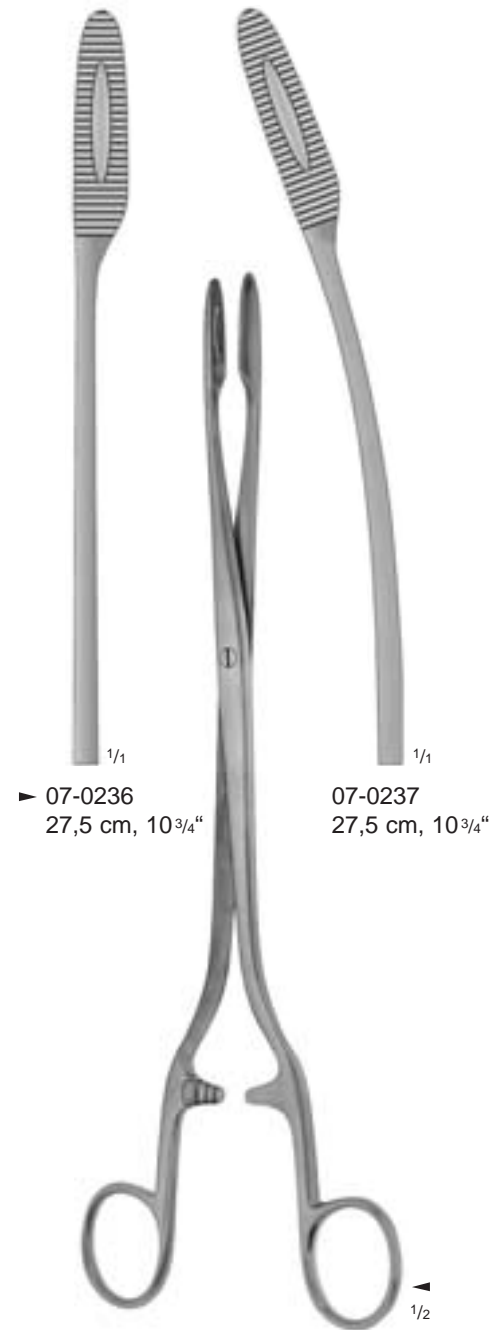

► 07-0236
 27,5 cm, 10³/₄"

07-0237
 27,5 cm, 10³/₄"

SIMS-MAIER
 07-0236
 - 07-0237
 mit Sperre
 with ratchet
 con cremallera
 avec crémaillère
 con cremagliera



Korn- und Tupferzangen
 Sponge and Dressing Forceps
 Pinzas para vendajes y torundas
 Pincas à pansements et tampons
 Pinze per medicatura e tamponi

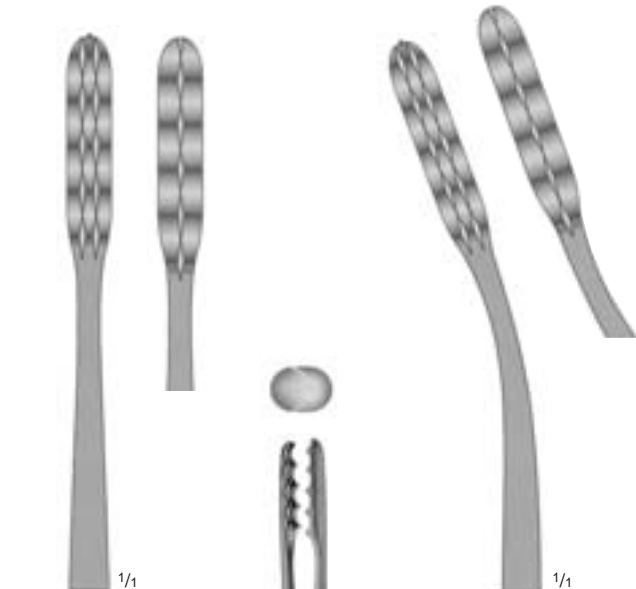

► 07-0216
 22 cm, 8³/₄"

07-0217
 22 cm, 8³/₄"



ULRICH
 07-0216
 - 07-0217
 mit Sperre
 with ratchet
 con cremallera
 avec crémaillère
 con cremagliera

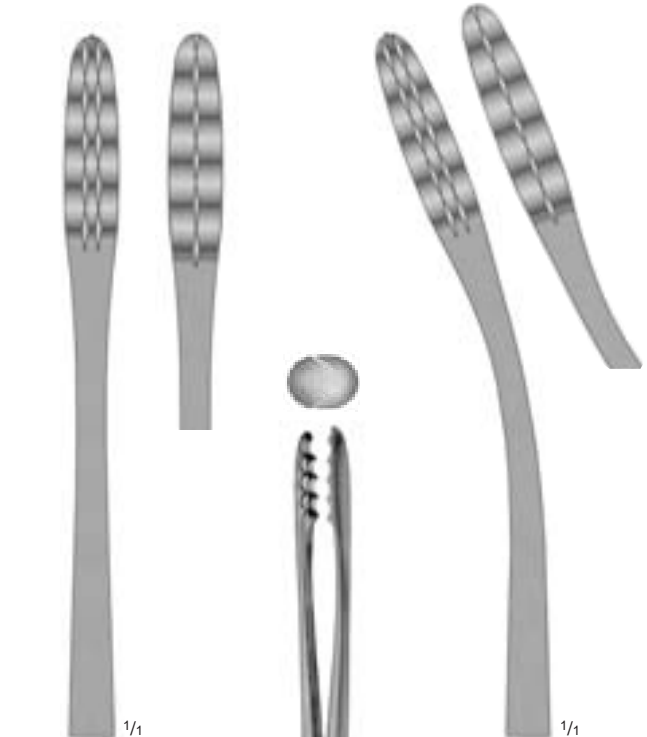

► 07-0218
 26 cm, 10¹/₄"

07-0219
 26 cm, 10¹/₄"

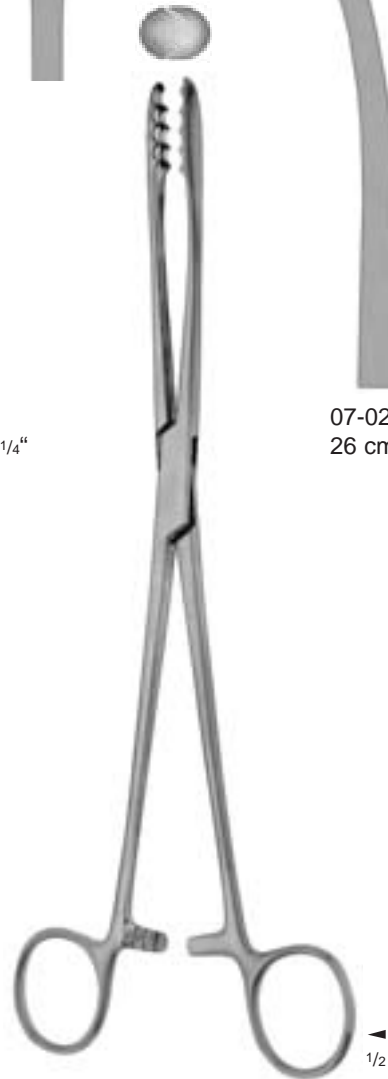

ULRICH
 07-0218
 - 07-0219
 mit Sperre
 with ratchet
 con cremallera
 avec crémaillère
 con cremagliera

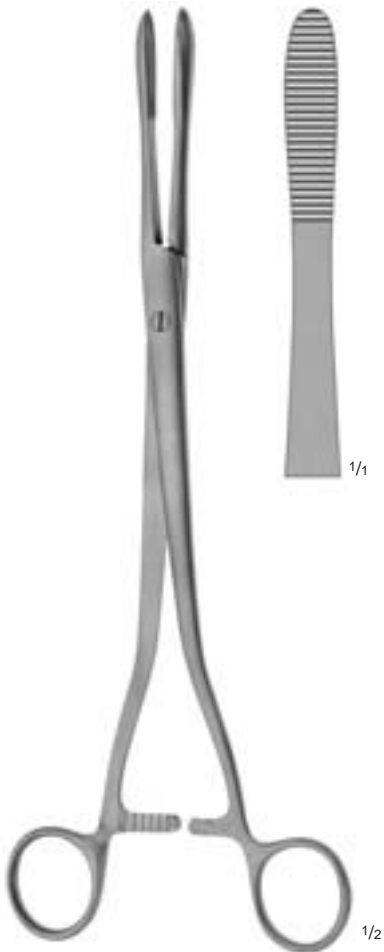

COLLIN
07-0243
25 cm, 10"



CHERON
07-0245
25,5 cm, 10"

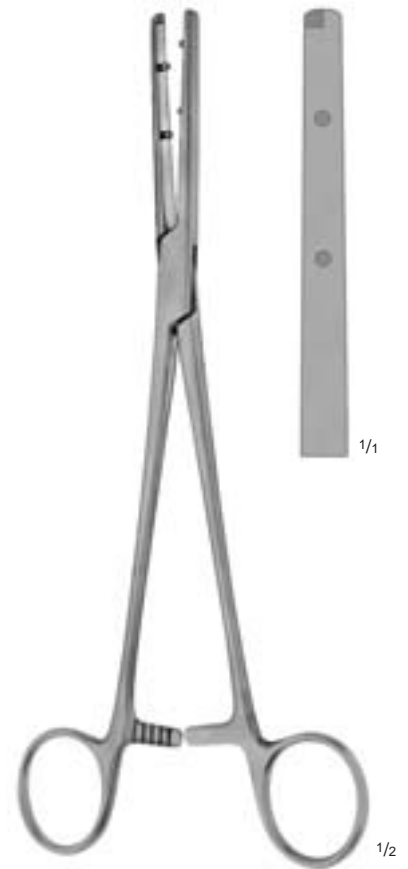

EMMET
07-0248
22,5 cm, 9"

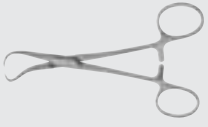

Tamponzangen
Uterine Dressing Forceps
Pinzas para tapones
Pinces à pansements
Pinze per medicature

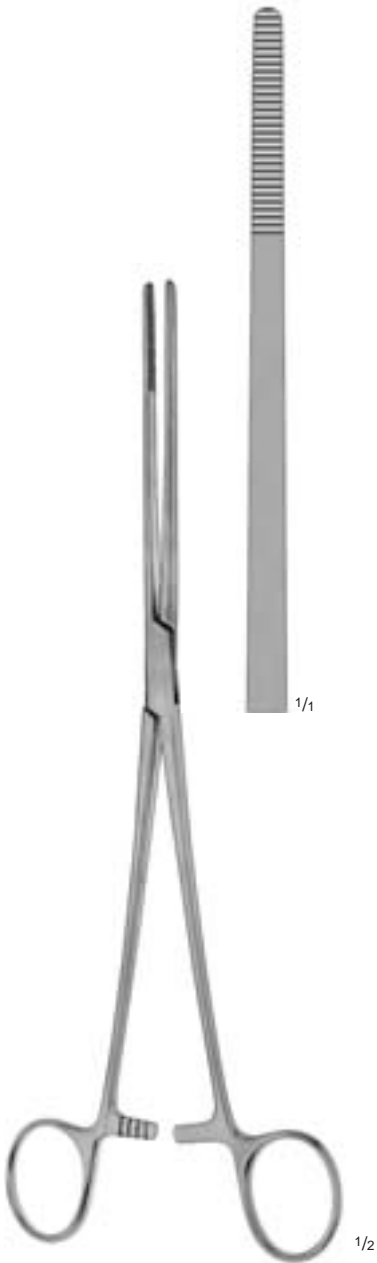

BOZEMANN
96-0110
26 cm, 10 1/4"

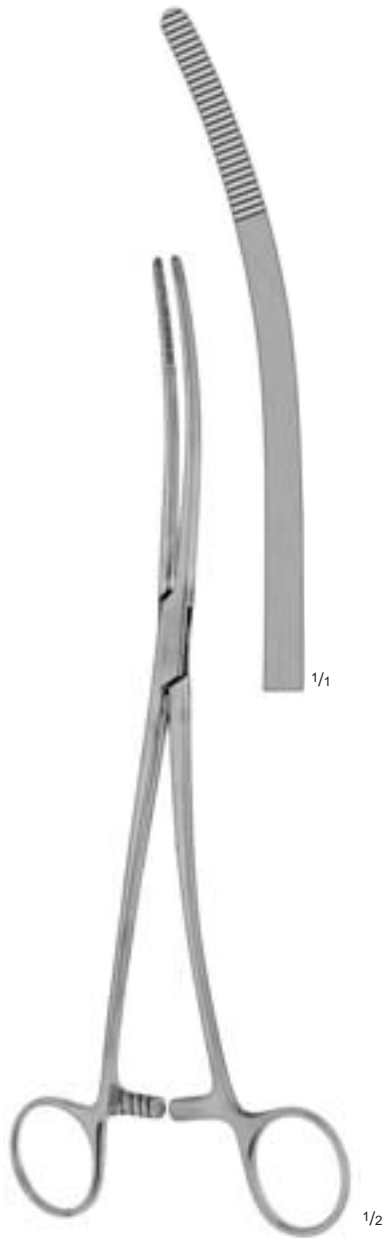

BOZEMANN
96-0105
26 cm, 10 1/4"

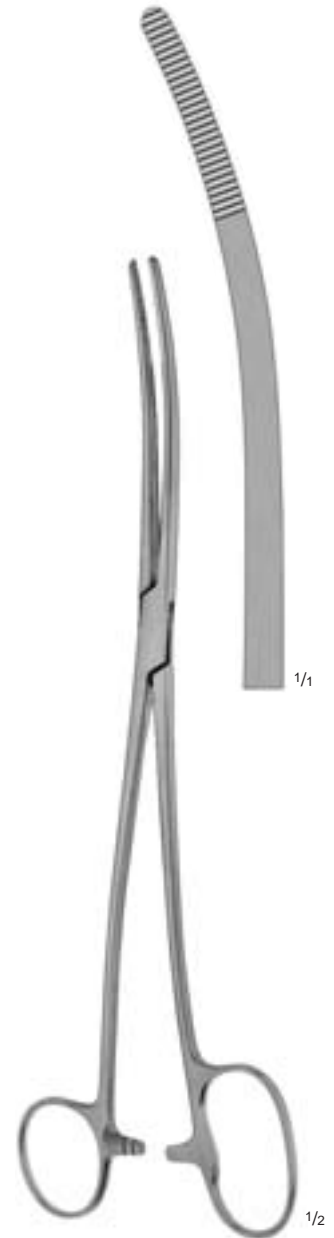

BOZEMANN-DOUGLAS
96-0100
26 cm, 10 1/4"

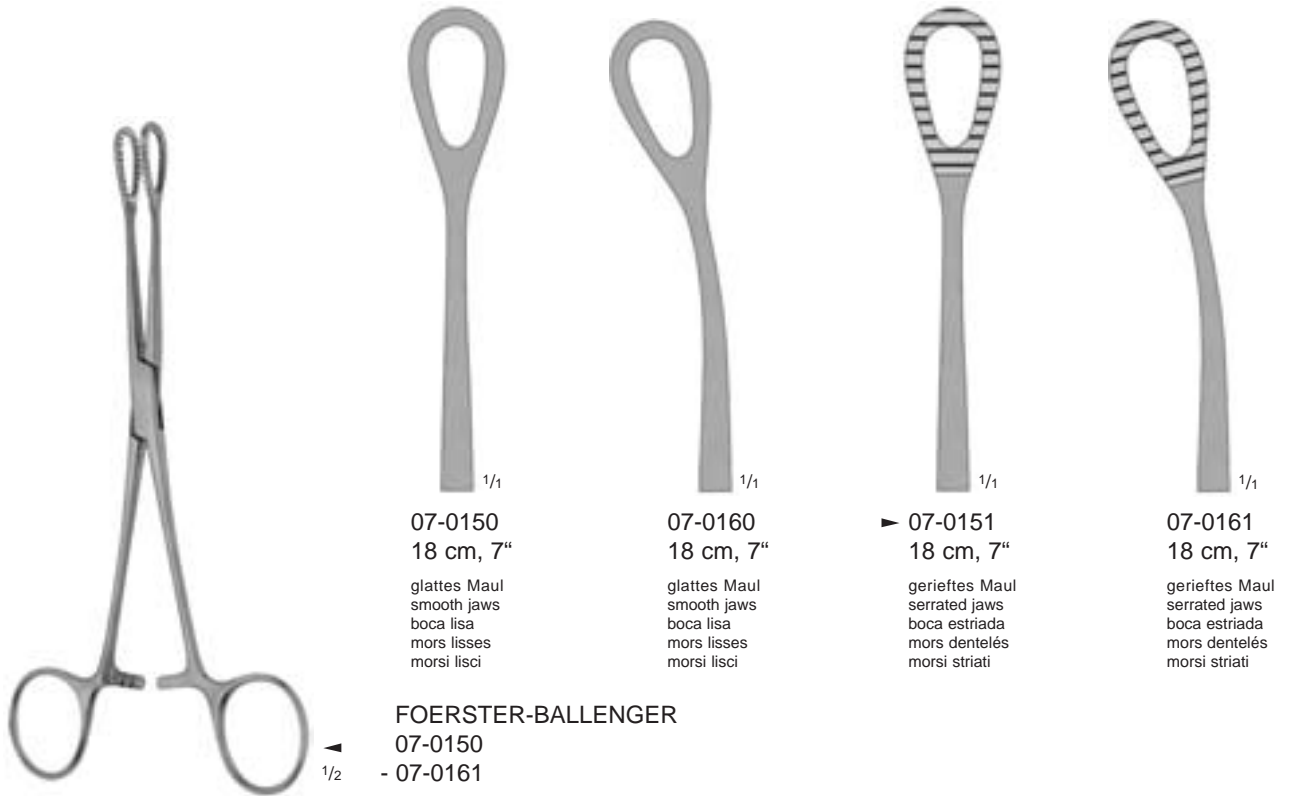

07-0150
 18 cm, 7"
 glattes Maul
 smooth jaws
 boca lisa
 mors lisses
 morsi lisci



07-0160
 18 cm, 7"
 glattes Maul
 smooth jaws
 boca lisa
 mors lisses
 morsi lisci



▶ 07-0151
 18 cm, 7"
 gerieftes Maul
 serrated jaws
 boca estriada
 mors dentelés
 morsi striati



07-0161
 18 cm, 7"
 gerieftes Maul
 serrated jaws
 boca estriada
 mors dentelés
 morsi striati

FOERSTER-BALLENGER
 07-0150
 - 07-0161

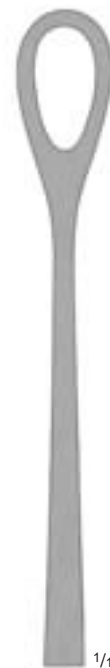
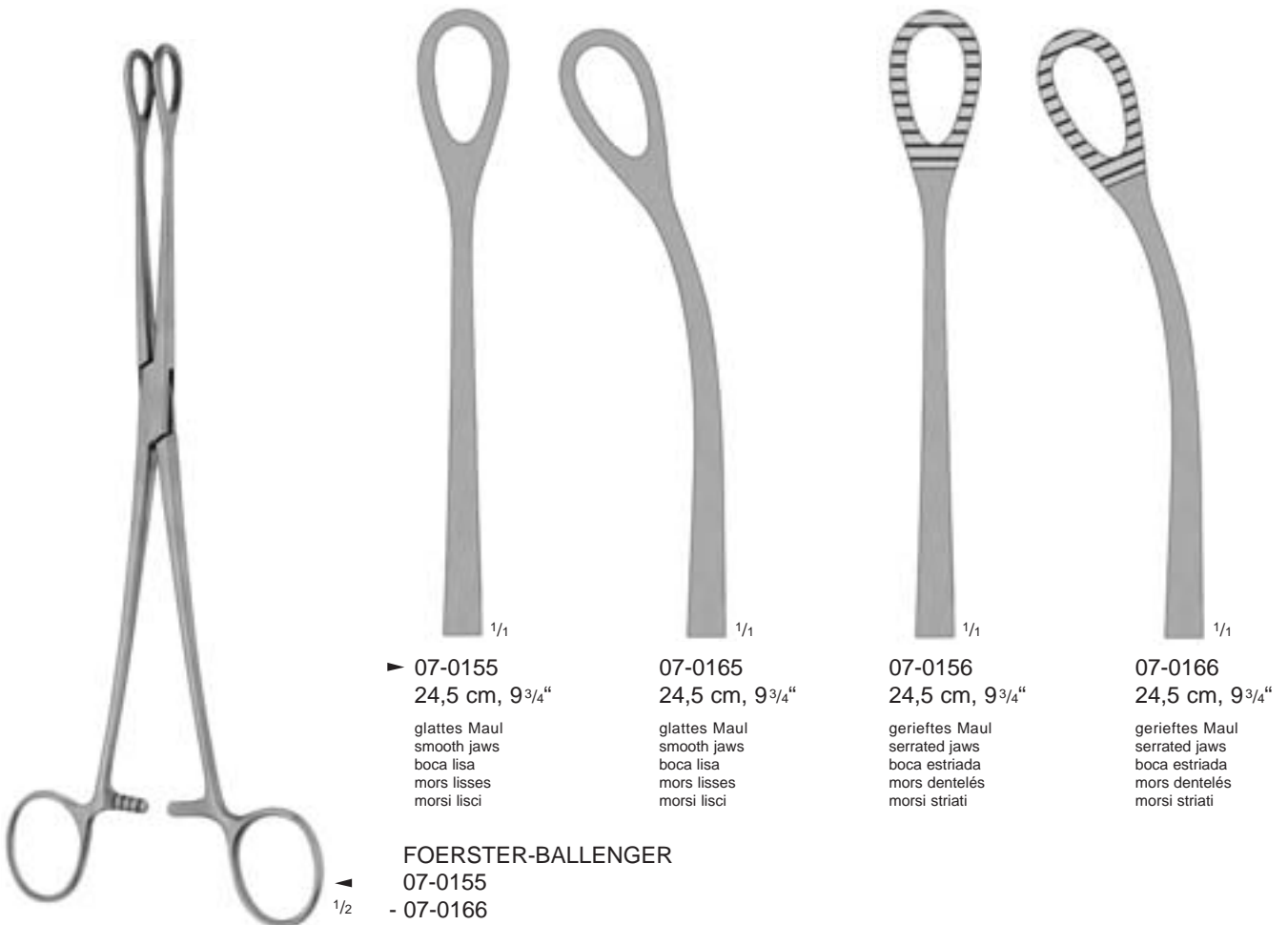

▶ 07-0155
 24,5 cm, 9 3/4"
 glattes Maul
 smooth jaws
 boca lisa
 mors lisses
 morsi lisci



07-0165
 24,5 cm, 9 3/4"
 glattes Maul
 smooth jaws
 boca lisa
 mors lisses
 morsi lisci



07-0156
 24,5 cm, 9 3/4"
 gerieftes Maul
 serrated jaws
 boca estriada
 mors dentelés
 morsi striati



07-0166
 24,5 cm, 9 3/4"
 gerieftes Maul
 serrated jaws
 boca estriada
 mors dentelés
 morsi striati

FOERSTER-BALLENGER
 07-0155
 - 07-0166



Tupfer- und Schwammzangen
Dressing and Sponge Holding Forceps
Pinzas para torundas y esponjas
Pincers à tampons et éponges
Pinze per tamponi e spugne

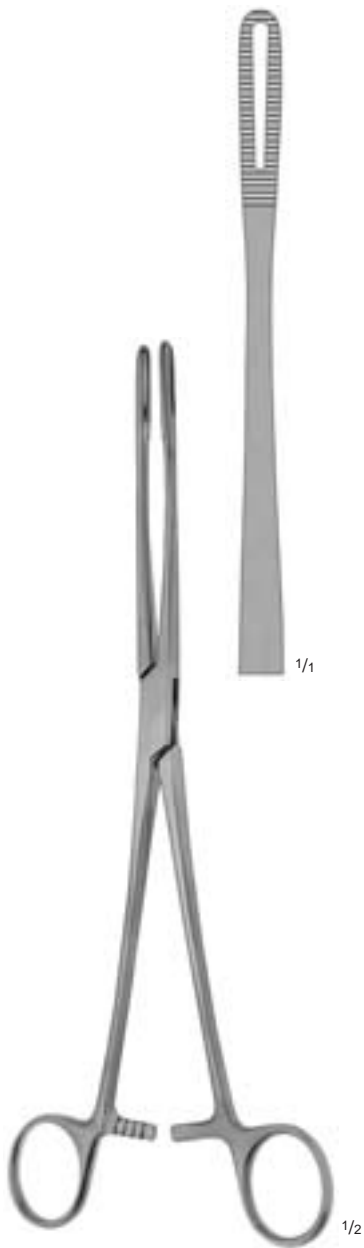

FORBES (FOERSTER)
96-0125
24 cm, 9 1/2"

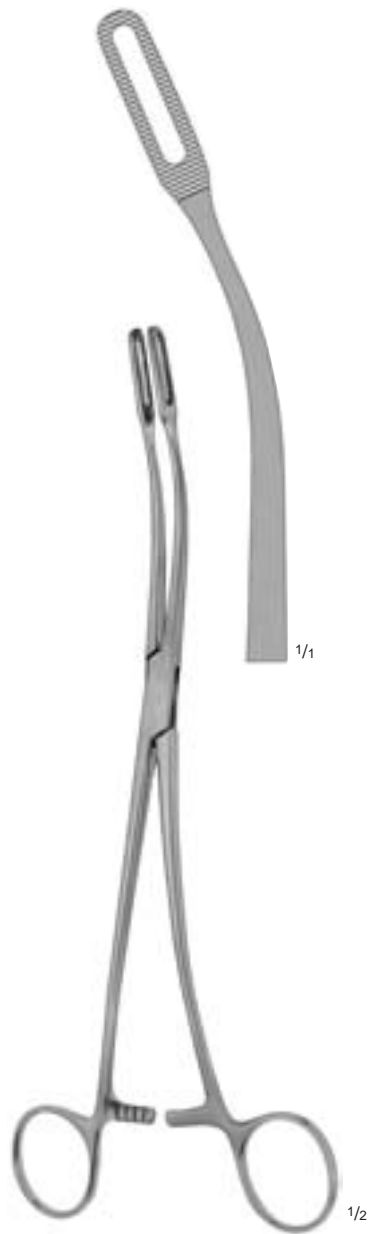

FLETCHER (JAVERTS)
07-0170
24 cm, 9 1/2"

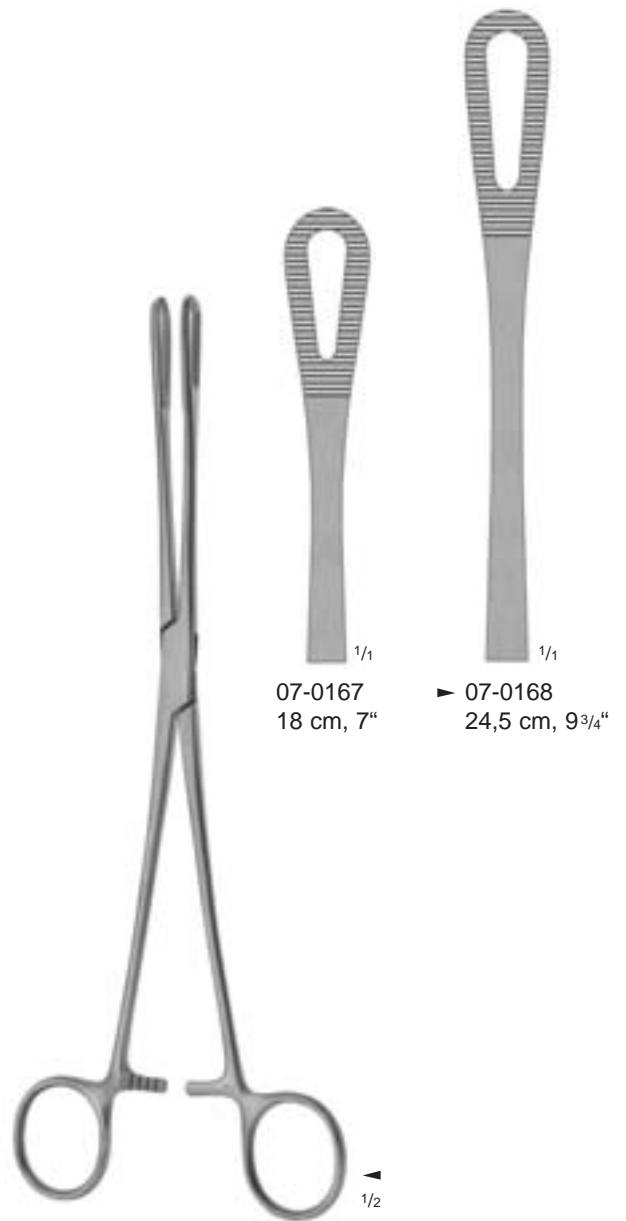

RAMPLEY
07-0167
- 07-0168

07-0167
18 cm, 7"

▶ 07-0168
24,5 cm, 9 3/4"

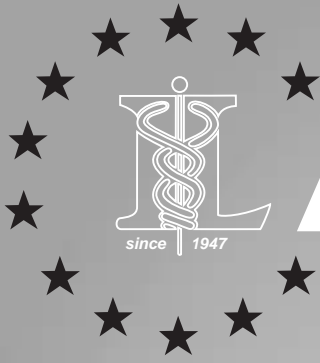

LAWNTON
Medizintechnik



Wundhaken
Retractors
Separadores
Ecarteurs
Divaricatori



Wundhäkchen
Retractors
Separadores
Ecarteurs
Divaricatori



1/2

68-1015
- 68-1028
15,5 cm, 6"

25°



1/1

SHAMBAUGH
68-1020 0,3 mm
68-1021 0,6 mm
▶ 68-1022 1,0 mm

45°



1/1

SHAMBAUGH
68-1023 0,3 mm
68-1024 0,6 mm
▶ 68-1025 1,0 mm

90°



1/1

SHAMBAUGH
68-1026 0,3 mm
68-1027 0,6 mm
▶ 68-1028 1,0 mm



1/1

68-1015 0,5 mm
▶ 68-1017 1,0 mm

Häkchen für die Mikrochirurgie
Hooks for micro surgery
Ganchos para la microcirugía
Crochets à microchirurgie
Crochet per microchirurgia



1/2

57-0860
18,5 cm, 7 1/4"

Durahäkchen
Dura retractor
Ganchito para dura-madre
Crochet pour la dure-mère
Uncino per dura-madre



1/2

FISCH
57-0861
18,5 cm, 7 1/4"

Durahäkchen
Dura retractor
Ganchito para dura-madre
Crochet pour la dure-mère
Uncino per dura-madre

ø 1,8 mm



1/2

57-0866
18 cm, 7"

Doppelkrallen zum Fassen und Anheben
von Haut und Gewebe
Double picks to grasp and lift skin and tissue
Doble garra para agarrar y alzar piel y tejido
Crochets doubles pour saisir et soulever la
peau, les tissus
Crochet doppio per afferrare e sollevare pelle e
tessuti

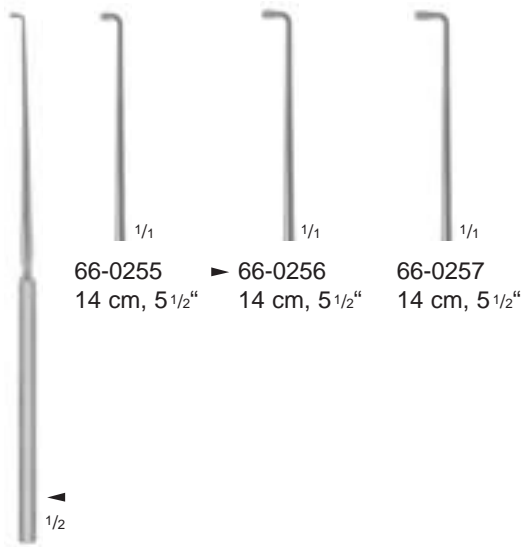

66-0255 14 cm, 5 1/2" ▶ 66-0256 14 cm, 5 1/2" 66-0257 14 cm, 5 1/2"

LUCAE
 66-0255
 - 66-0257

Ohrhäkchen
 Ear hooklets
 Ganchitos auriculares
 Crochets auriculaires
 Crochet auricolare

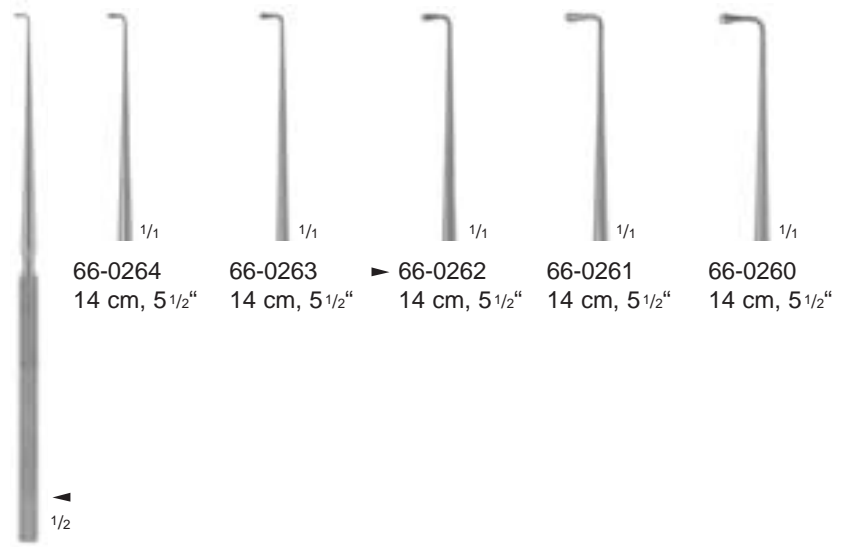

66-0264 14 cm, 5 1/2" 66-0263 14 cm, 5 1/2" ▶ 66-0262 14 cm, 5 1/2" 66-0261 14 cm, 5 1/2" 66-0260 14 cm, 5 1/2"

WAGENER
 66-0260
 - 66-0264

Ohrhäkchen
 Ear hooklets
 Ganchitos auriculares
 Crochets auriculaires
 Crochet auricolare

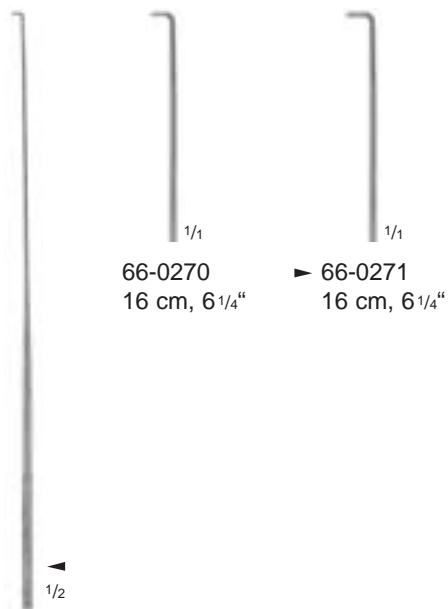

66-0270 16 cm, 6 1/4" ▶ 66-0271 16 cm, 6 1/4"

DAY
 66-0270
 - 66-0271

Ohrhäkchen
 Ear hooklets
 Ganchitos auriculares
 Crochets auriculaires
 Crochet auricolare

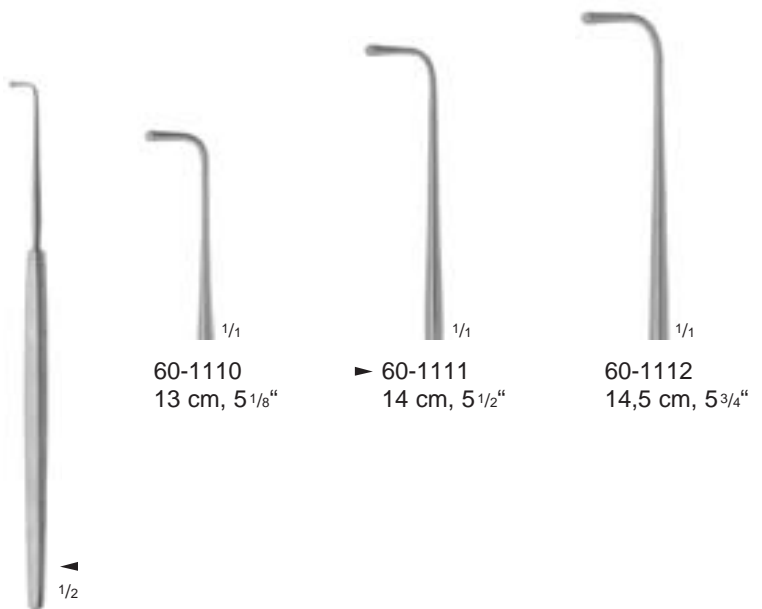

60-1110 13 cm, 5 1/8" ▶ 60-1111 14 cm, 5 1/2" 60-1112 14,5 cm, 5 3/4"

GRAEFE
 60-1110
 - 60-1112

Schielhaken
 Strabismus hooks
 Ganchos para estrabismo
 Crochets à strabisme
 Crochet per strabismo



Nerv- und Gefäßhäkchen
 Nerve and Vessel Hooks
 Ganchos para nervios y vasos
 Crochets à nerfs et à vaisseaux
 Uncini per nervi e vasi



DANDY
 51-0660
 21,5 cm, 8 1/2"
 gerade
 straight
 recto
 droit
 retti



DANDY
 51-0662
 21,5 cm, 8 1/2"
 links
 left
 izquierdo
 à gauche
 sinistro



DANDY
 51-0661
 21,5 cm, 8 1/2"
 rechts
 right
 derecho
 à droite
 destro

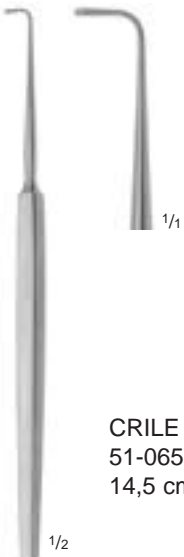
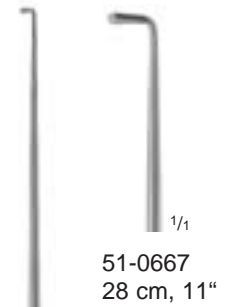
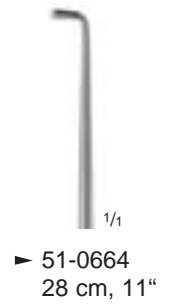

CRILE
 51-0657
 14,5 cm, 5 3/4"

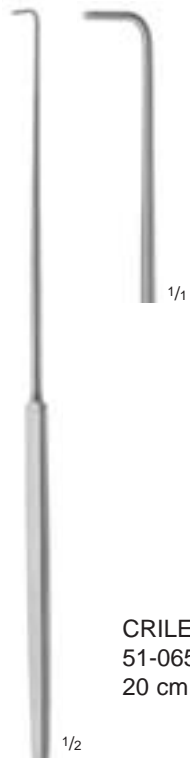

CRILE
 51-0658
 20 cm, 8"

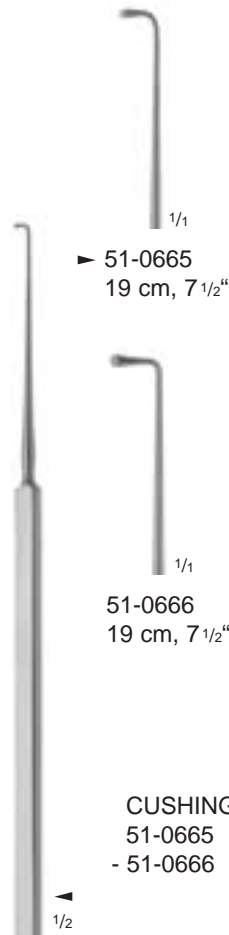

CUSHING
 51-0665
 - 51-0666



CUSHING
 51-0664
 - 51-0667

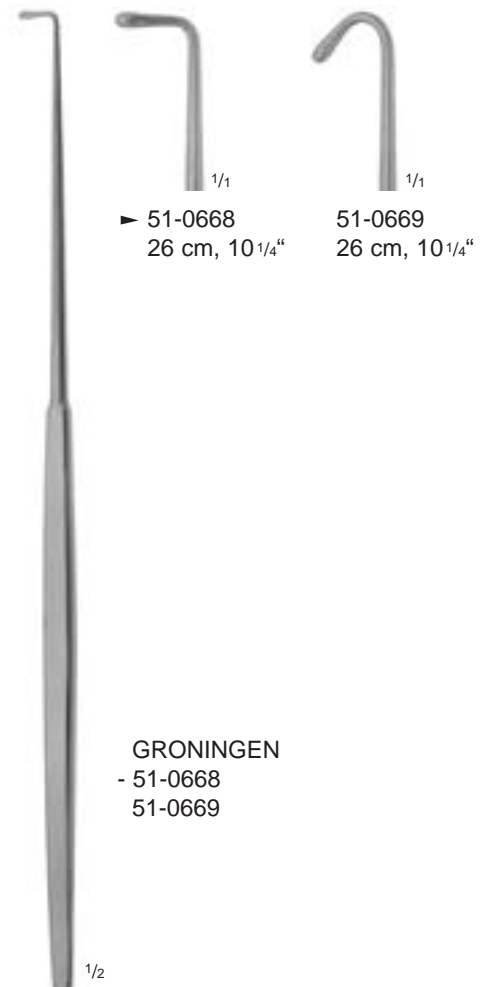
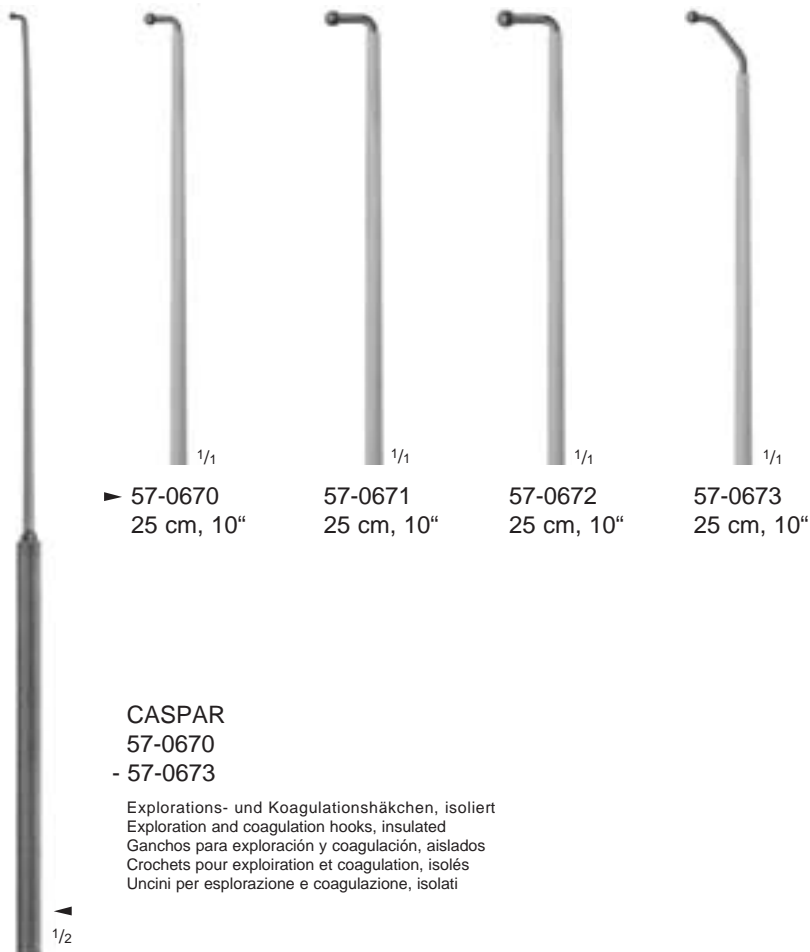
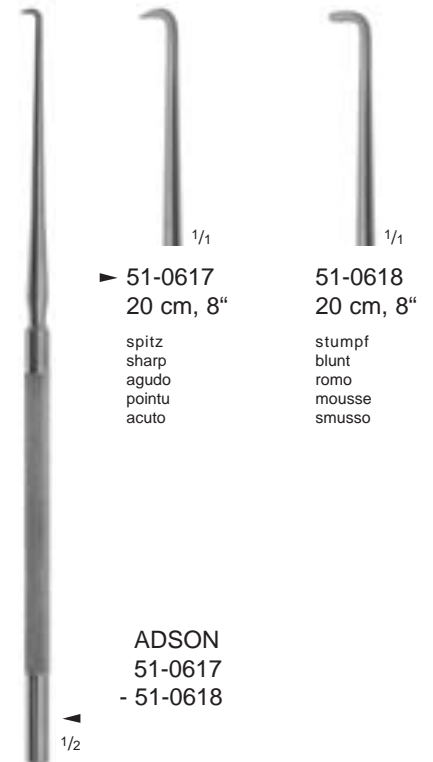
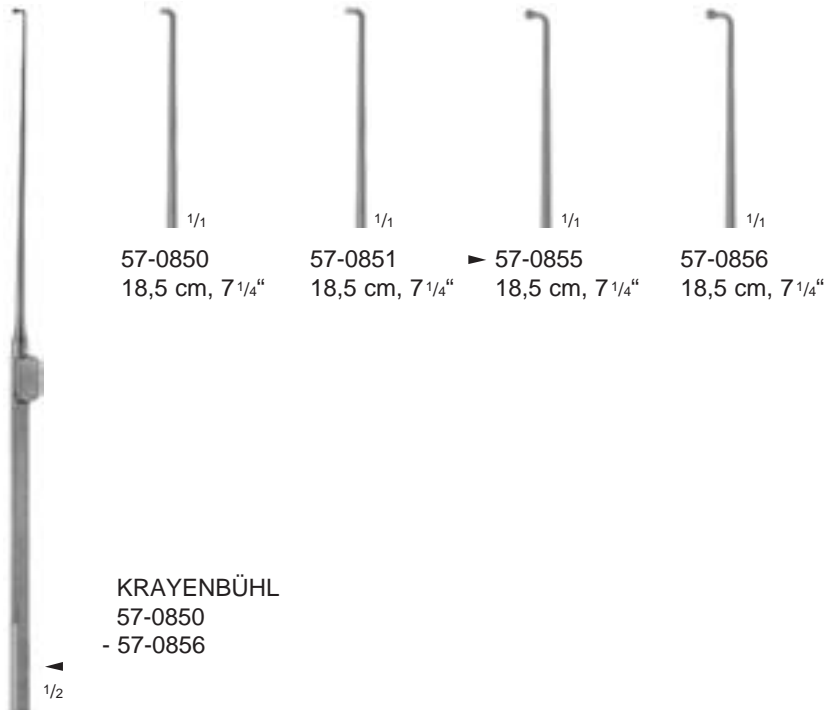



Wundhäkchen
Retractors
Separadores
Ecarteurs
Divaricatori



▶ 60-1215
12 cm, 4³/₄"

spitz
sharp
agudo
pointu
acuto

1/2

GRAEFE (TYRELL)

60-1215

- 60-1216

Hauthäkchen (Irishäkchen)
Skin retractors (iris hooks)
Ganchos para piel (gancho para iris)
Crochets à peau (Iris)
Divaricatori cutaneo (uncini per iride)



1/1



1/1

60-1216
12 cm, 4³/₄"

stumpf
blunt
romo
mousse
smusso



1/2

FRAZIER

51-0615

12,5 cm, 5"

Dura- und Hauthäkchen, spitz
Dura and skin retractor, sharp
Gancho para piel y dura-madre, agudo
Crochet à peau et à dure-mère, pointu
Divaricatore per pelle e dura-madre, acuto



1/1



1/2

KILNER

75-0220

13 cm, 5¹/₈"

Hauthäkchen, spitz
Skin retractor, sharp
Gancho para piel, agudo
Crochet à peau, pointu
Divaricatore cutaneo, acuto



1/1



1/2

KILNER

75-0218

15 cm, 6"

Hauthäkchen, spitz
Skin retractor, sharp
Gancho para piel, agudo
Crochet à peau, pointu
Divaricatore cutaneo, acuto



1/1



1/2

GILLIES

75-0215

18 cm, 7"

Hauthäkchen, spitz
Skin retractor, sharp
Gancho para piel, agudo
Crochet à peau, pointu
Divaricatore cutaneo, acuto



1/1



1/2

GILLIES (CONVERSE)

75-0221

- 75-0222

Dura- und Hauthäkchen, spitz
Dura and skin retractors, sharp
Ganchos para piel y dura-madre, agudo
Crochets à peau et à dure-mère, pointus
Divaricatori per pelle e dura-madre, acuto



1/1

▶ 75-0221
18,5 cm, 7¹/₄"



1/1

75-0222
18,5 cm, 7¹/₄"



MOLDESTAD
 30-0100
 12 cm, 4 3/4"

Venenhaken
 Vein retractor
 Separador para venas
 Ecarteur à veines
 Divaricatore per vene

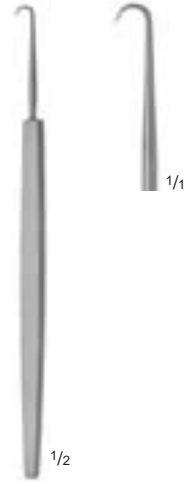

O'CONNOR
 60-1260
 12,5 cm, 5"

Hauthäkchen (Irishäkchen), spitz
 Skin retractor (iris hook), sharp
 Gancho para piel (gancho para iris), agudo
 Crochet à peau (Iris), pointu
 Uncino cutaneo (uncino per iride), acuto

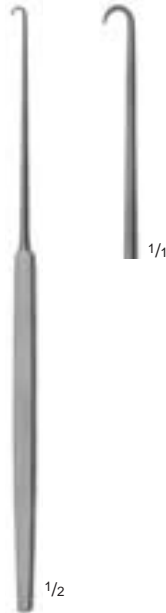

COTTLE
 51-0612
 16 cm, 6 1/4"

Dura- und Hauthäkchen, spitz
 Dura and skin retractor, sharp
 Gancho para piel y dura-madre, agudo
 Crochet à peau et à dure-mère, pointu
 Uncino per pelle e dura-madre, acuto

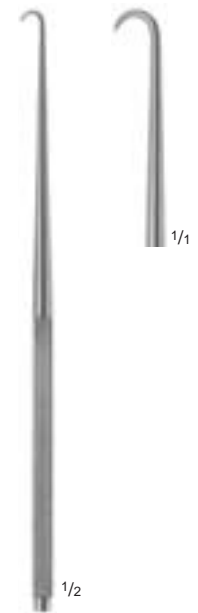

JOSEPH
 75-0330
 16 cm, 6 1/4"

Häkchen für plastische Chirurgie, spitz
 Hook for plastic surgery, sharp
 Gancho para cirugía plástica, agudo
 Crochet pour la chirurgie plastique, pointu
 Uncino per chirurgia plastica, acuto



GRAHAM
 51-0610
 17 cm, 6 3/4"

Durahäkchen, stumpf
 Dura hook, blunt
 Gancho para dura-madre, romo
 Crochet pour la dure-mère, mousse
 Uncino per dura-madre, smusso



SACHS
 51-0613
 18,5 cm, 7 1/4"

Durahäkchen, spitz
 Dura hook, sharp
 Gancho para dura-madre, agudo
 Crochet pour la dure-mère, pointu
 Uncino per dura-madre, acuto



NEWS
 87-0135
 14,5 cm, 5 3/4"

Trachealhäkchen, spitz
 Trachea retractor, sharp
 Separador para la tráquea, agudo
 Ecarteur pour trachéotomie, pointu
 Uncino tracheale, acuto

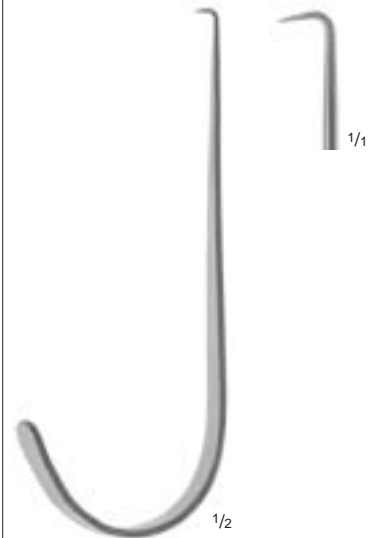

JACKSON
 87-0140
 14 cm, 5 1/2"

Trachealhäkchen, spitz
 Trachea retractor, sharp
 Separador para la tráquea, agudo
 Ecarteur pour trachéotomie, pointu
 Uncino tracheale, acuto



Wundhäkchen
Retractors
Separadores
Ecarteurs
Divaricatori

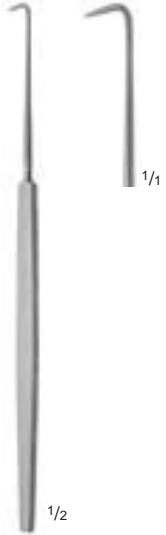

CUSHING
51-0600
14 cm, 5 1/2"

Durahäkchen, spitz
Dura hook, sharp
Gancho para dura-madre, agudo
Crochet pour la dure-mère, pointu
Uncino per dura-madre, acuto



COTTLE
75-0400
17 cm, 6 3/4"

Häkchen für plastische Chirurgie, spitz
Hook for plastic surgery, sharp
Gancho para cirugía plástica, agudo
Crochet pour la chirurgie plastique, pointu
Uncino per chirurgia plastica, acuto

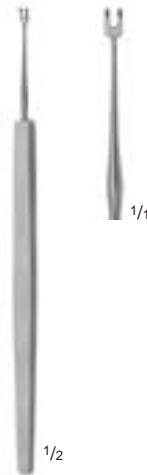

GUTHRIE
60-1221
12,5 cm, 5"

Hauthäkchen (Irishäkchen), spitz
Skin retractor (iris hook), sharp
Gancho para piel (gancho para iris), agudo
Crochet à plaies (Iris), pointu
Divaricatore cutaneo (uncino per iride), acuto

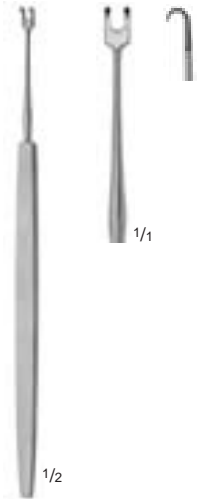

GUTHRIE
60-1220
13 cm, 5 1/8"

Hauthäkchen (Irishäkchen), spitz
Skin retractor (iris hook), sharp
Gancho para piel (gancho para iris), agudo
Crochet à plaies (Iris), pointu
Divaricatore cutaneo (uncino per iride), acuto

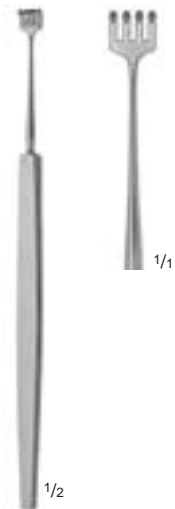

ROLLET
20-0100
13,5 cm, 5 1/4"

spitz
sharp
agudo
pointu
acuto

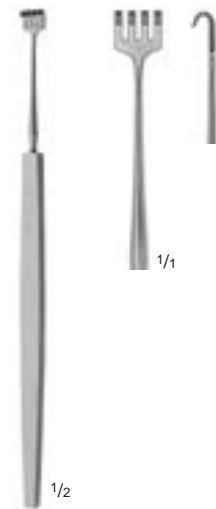

KNAPP
20-0101
13,5 cm, 5 1/4"

stumpf
blunt
romo
mousse
smusso

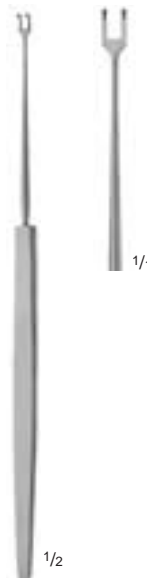

FREER
75-0325
15 cm, 6"

spitz
sharp
agudo
pointu
acuto

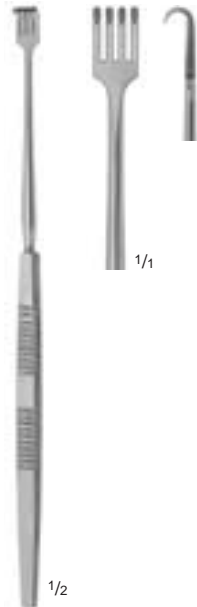

KNAPP
20-0105
16 cm, 6 1/4"

spitz
sharp
agudo
pointu
acuto

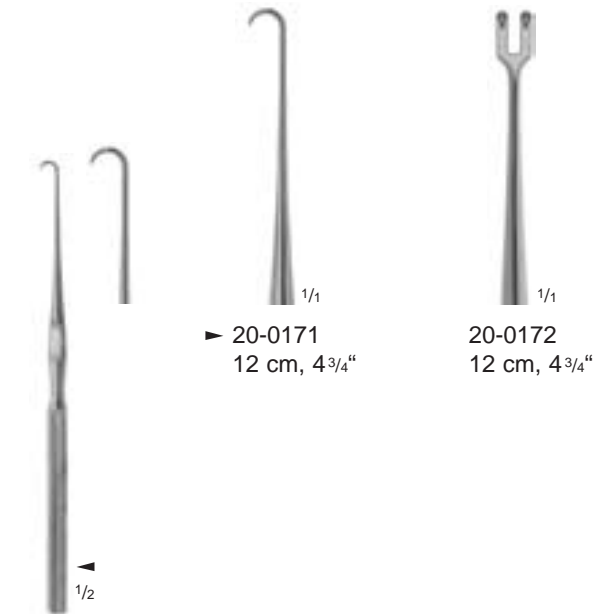

▶ 20-0171
12 cm, 4³/₄"

20-0172
12 cm, 4³/₄"

LAHEY
20-0171
- 20-0172

spitz
sharp
agudo
pointu
acuto

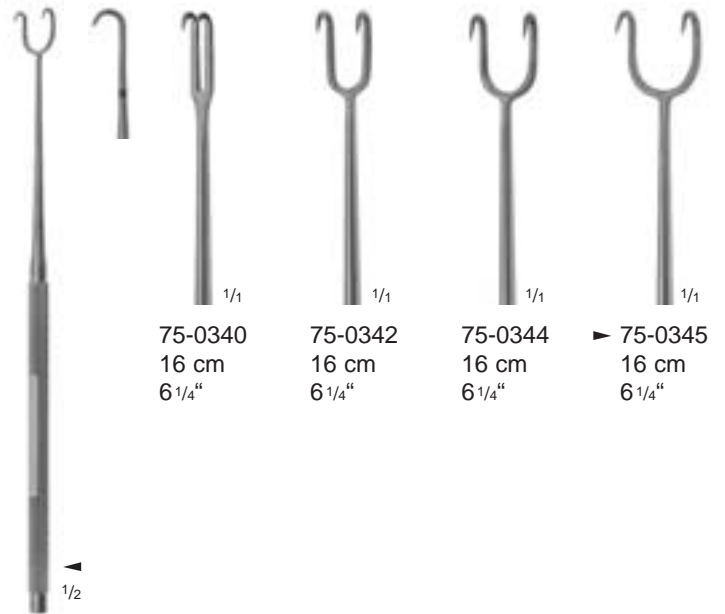

75-0340
16 cm
6¹/₄"

75-0342
16 cm
6¹/₄"

75-0344
16 cm
6¹/₄"

▶ 75-0345
16 cm
6¹/₄"

JOSEPH
75-0340
- 75-0345

Häkchen für plastische Chirurgie, spitz
Hooks for plastic surgery, sharp
Ganchos para cirugía plástica, agudos
Crochets pour la chirurgie plastique, pointu
Uncini per chirurgia plastica, acuti

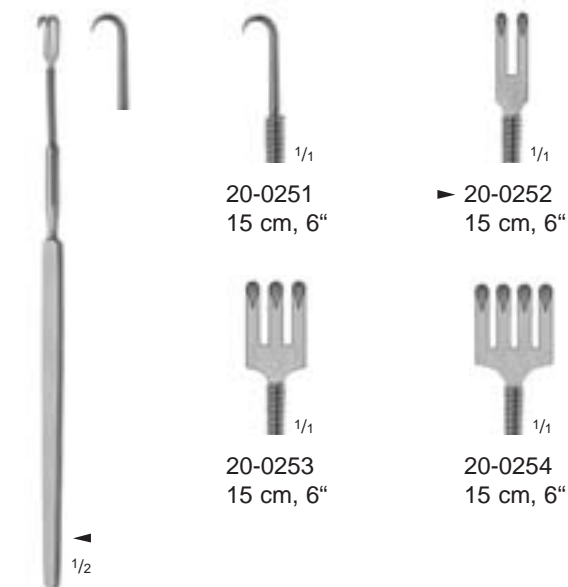

20-0251
15 cm, 6"

▶ 20-0252
15 cm, 6"

20-0253
15 cm, 6"

20-0254
15 cm, 6"

20-0251
- 20-0254

Trachealhäkchen, spitz / flexibel
Trachea retractors, sharp / flexible
Separadores para la tráquea, agudos / flexibles
Ecarteurs pour trachéotomie, pointu / flexible
Uncini tracheali, acuti / flessibili

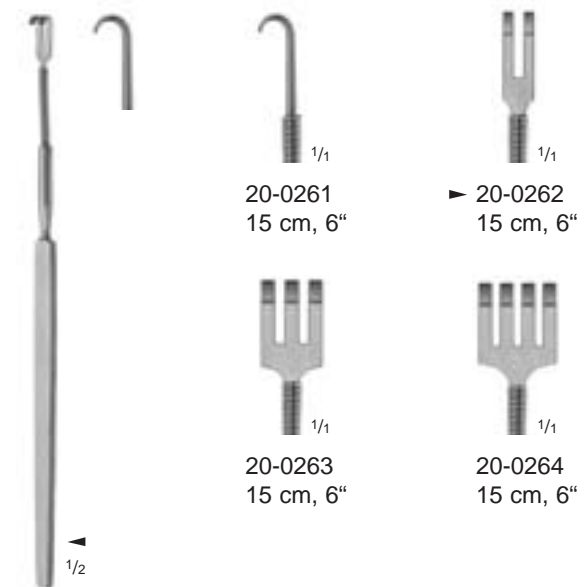

20-0261
15 cm, 6"

▶ 20-0262
15 cm, 6"

20-0263
15 cm, 6"

20-0264
15 cm, 6"

20-0261
- 20-0264

Trachealhäkchen, stumpf / flexibel
Trachea retractors, blunt / flexible
Separadores para la tráquea, romos / flexibles
Ecarteurs pour trachéotomie, mousse / flexible
Uncini tracheali, smussi / flessibili



Wundhäkchen
Retractors
Separadores
Ecarteurs
Divaricatori

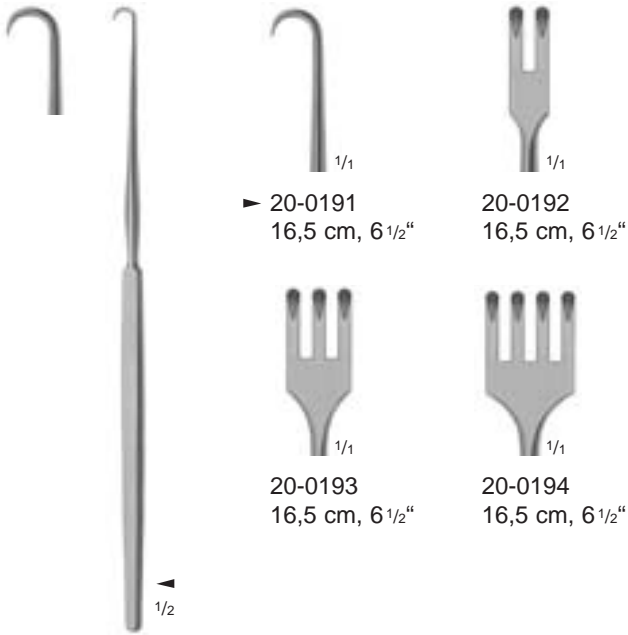

20-0191
- 20-0194

Trachealhäkchen, spitz
Trachea retractors, sharp
Separadores para la tráquea, agudos
Ecarteurs pour trachéotomie, pointu
Uncini tracheali, acuti

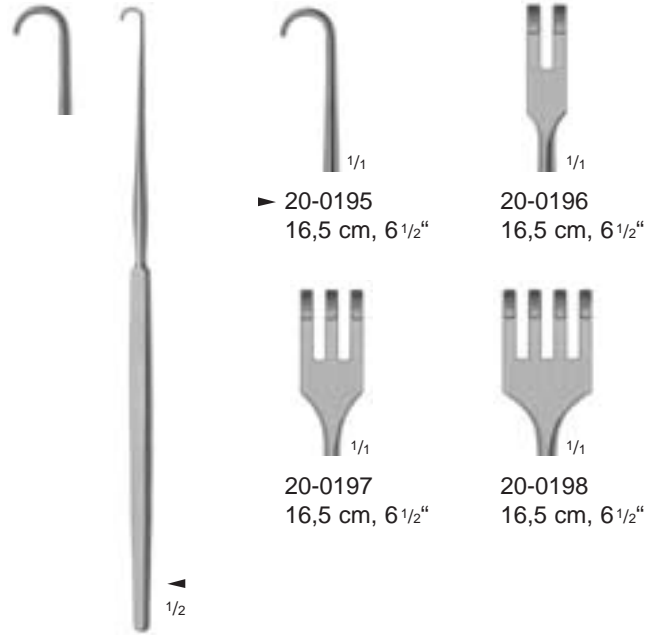

20-0195
- 20-0198

Trachealhäkchen, stumpf
Trachea retractors, blunt
Separadores para la tráquea, romos
Ecarteurs pour trachéotomie, mousse
Uncini tracheali, smussi

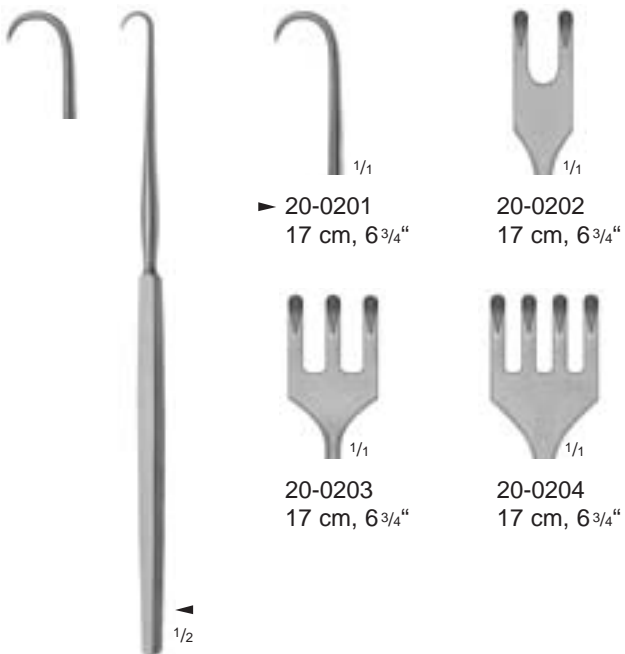

20-0201
- 20-0204

Trachealhäkchen, spitz
Trachea retractors, sharp
Separadores para la tráquea, agudos
Ecarteurs pour trachéotomie, pointu
Uncini tracheali, acuti

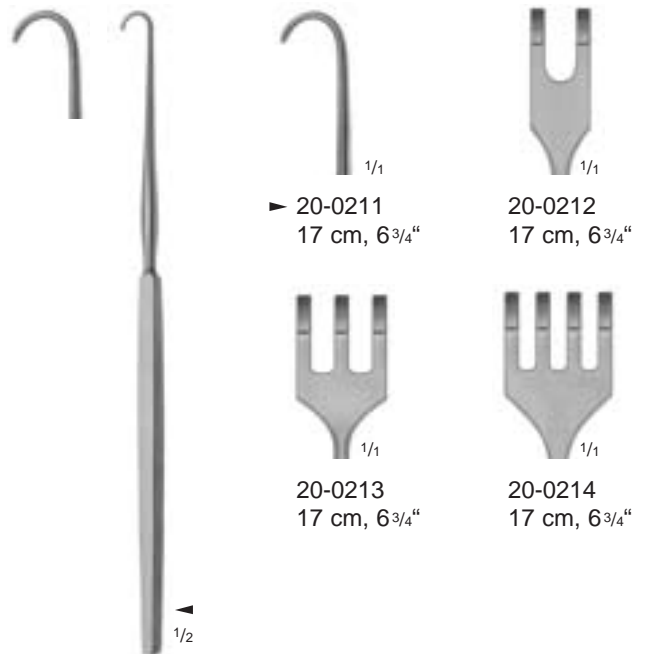

20-0211
- 20-0214

Trachealhäkchen, stumpf
Trachea retractors, blunt
Separadores para la tráquea, romos
Ecarteurs pour trachéotomie, mousse
Uncini tracheali, smussi



SACHS
 51-0650
 21,5 cm, 8 1/2"
 Fistelhaken
 Fistula hook
 Gancho para fistulas
 Crochet pour fistules
 Uncino per fistole



EMMET
 96-0251
 22 cm, 8 3/4"
 Fistelhaken
 Fistula hook
 Gancho para fistulas
 Crochet pour fistules
 Uncino per fistole

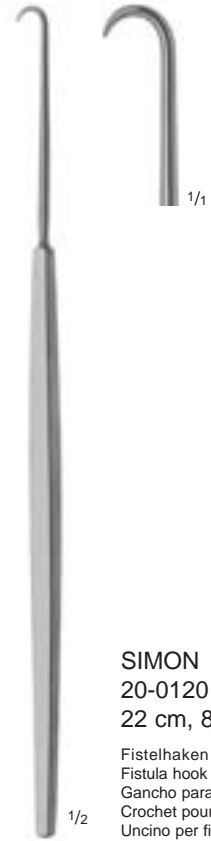

SIMON
 20-0120
 22 cm, 8 3/4"
 Fistelhaken
 Fistula hook
 Gancho para fistulas
 Crochet pour fistules
 Uncino per fistole



FOMON
 75-0430
 16 cm, 6 1/4"
 Choanenhook
 Hook for posterior nares
 Gancho para las coanas
 Crochet nasal
 Uncino per narici posteriori



FOMON
 75-0435
 16 cm, 6 1/4"
 Nasenflügelhaken
 Hook for posterior nares
 Gancho para las coanas
 Crochet nasal
 Uncino per narici posteriori



COTTLE-NEIVERT
 75-0412
 20,5 cm, 8"
 Nasenflügelhaken mit Säge- oder
 Messerführung
 Hook for posterior nares with saw
 or knife guide
 Gancho para las coanas con guía
 para sierra o para cuchillo
 Crochet nasal avec scie ou couteau
 guides
 Uncino per narici posteriori con guida
 per lama o coltello



Wundhaken
Retractors
Separadores
Ecarteurs
Divaricatori

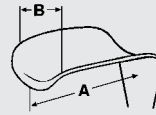

60-1208
4,5 x 8 mm (AxB)



60-1199
9 x 10 mm (AxB)



60-1200
9 x 12 mm (AxB)



60-1201
11 x 14 mm (AxB)



▶ 60-1202
12 x 16 mm (AxB)



60-1203
13 x 18 mm (AxB)



1/2

DESMARRES

60-1199
- 60-1208
14 cm, 5 1/2"

Venenhaken (Lidhalter)
Vein retractors (lid retractors)
Separadores para venas
(separadores para párpados)
Ecarteurs à veines
(releveurs de paupières)
Divaricatori per vene
(Divaricatori palpebra)



30-0040
4,5 x 8 mm (AxB)



30-0041
9 x 10 mm (AxB)



30-0042
9 x 12 mm (AxB)



30-0043
11 x 14 mm (AxB)



▶ 30-0044
12 x 16 mm (AxB)



30-0045
13 x 18 mm (AxB)



1/2

CUSHING

30-0040
- 30-0045
20 cm, 8"

Venenhaken
Vein retractors
Separadores para venas
Ecarteurs à veines
Divaricatori per vene



30-0090
4,5 x 8 mm (AxB)



30-0091
9 x 10 mm (AxB)



30-0092
9 x 12 mm (AxB)



30-0093
11 x 14 mm (AxB)



▶ 30-0094
12 x 16 mm (AxB)



30-0095
13 x 18 mm (AxB)



1/2

CUSHING

30-0090
- 30-0095
24 cm, 9 1/2"

Venenhaken
Vein retractors
Separadores para venas
Ecarteurs à veines
Divaricatori per vene

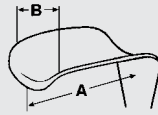

CUSHING
20-0495
22,5 cm, 9"

Venenhaken
Vein retractor
Separador para venas
Ecarteur à veines
Divaricatore per vene

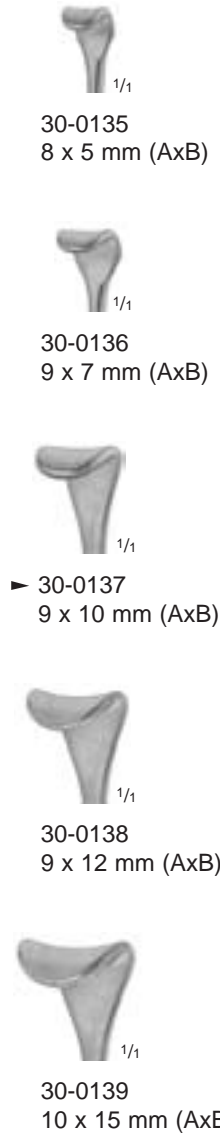

KIRKLIN
30-0135
- 30-0139
13,5 cm, 5 1/4"

Venenhaken , biegsam
Vein retractors , malleable
Separadores para venas, maleables
Ecarteurs à veines, malléables
Divaricatori per veni, malleabili

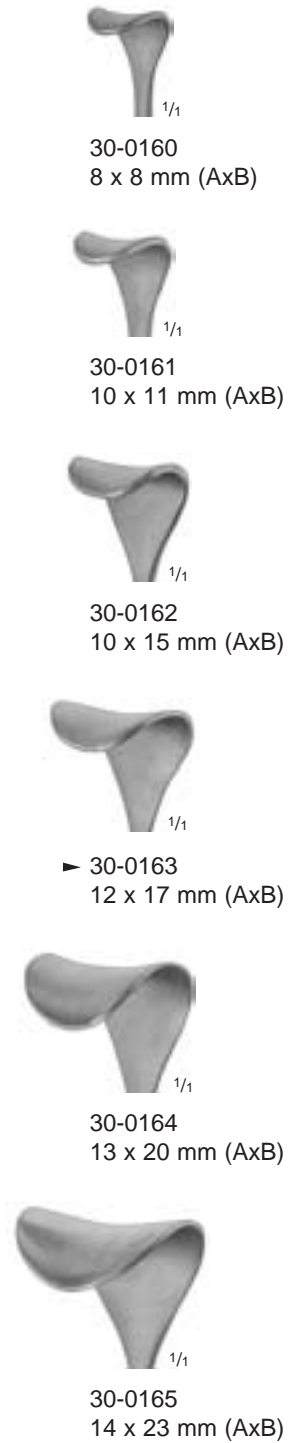

MARBERGER (GIL-VERNET)
30-0160
- 30-0165
24 cm, 9 1/2"

Venen- und Hilushaken, biegsam
Vein and hilar retractors, malleable
Separadores para venas y hilares, maleables
Ecarteurs à veines et à hile rénal, malléables
Divaricatori per veni e hilus, malleabili



Wundhaken
Retractors
Separadores
Ecarteurs
Divaricatori

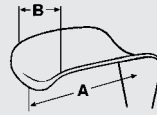

▶ 20-0102
10 x 6 mm (AxB)



20-0103
20 x 6 mm (AxB)

1/2

SENN-GREEN
20-0102
- 20-0103
16 cm, 6 1/4"



▶ 20-0106
10 x 6 mm (AxB)

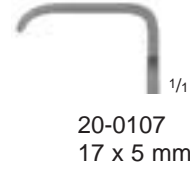

20-0107
17 x 5 mm (AxB)

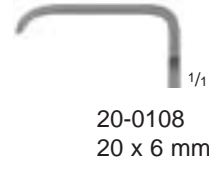

20-0108
20 x 6 mm (AxB)

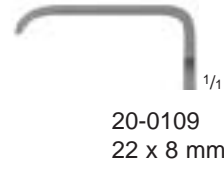

20-0109
22 x 8 mm (AxB)

1/2

MINI-LANGENBECK
20-0106
- 20-0109
16 cm, 6 1/4"



▶ 20-0110
16 x 5 mm (AxB)



20-0111
18 x 5 mm (AxB)



20-0112
25 x 6 mm (AxB)

1/2

MOBERG
20-0110
- 20-0112
17,5 cm, 7"

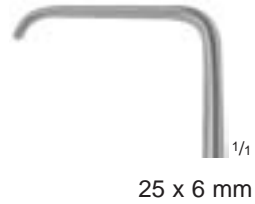

25 x 6 mm (AxB)

LAHEY
12-0340
20 cm, 8"

Kropfwundhaken
Goitre retractor
Separador para bocio
Ecarteur à goitre
Divaricatore per gozzo

1/2

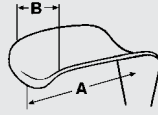

11 x 7 mm (AxB)

PAUL
 63-2965
 12,5 cm, 5"

Sehnscheidenhaken
 Tendon sheath retractor
 Separador para vainas tendinosas
 Ecarteur à gaines tendineuses
 Divaricatori per guaina tendinea



20-0176
 12 x 6 mm (AxB)



20-0177
 12 x 11 mm (AxB)



20-0179
 15 x 11 mm (AxB)

KLAPP
 20-0176
 - 20-0179
 17,5 cm, 7"

Sehnscheidenhaken
 Tendon sheath retractors
 Separadores para vainas tendinosas
 Ecarteurs à gaines tendineuses
 Divaricatori per guaina tendinea



20-0115
 15 x 6 mm (AxB)



20-0114
 15 x 6 mm (AxB)

STRANDELL-STILLE
 20-0114
 - 20-0115
 19 cm, 7 1/2"

Sehnscheidenhaken
 Tendon sheath retractors
 Separadores para vainas tendinosas
 Ecarteurs à gaines tendineuses
 Divaricatori per guaina tendinea



20-0132
 18 x 7 mm (AxB)



20-0133
 16 x 5 mm (AxB)



20-0134
 7 x 4 mm (AxB)



20-0135
 10 x 3 mm (AxB)



20-0136
 7 x 4 mm (AxB)



20-0137
 7 x 9 mm (AxB)

MEYERDING
 20-0132
 - 20-0137
 17,5 cm, 7"



Wundhaken, doppelendig
 Retractors, double-ended
 Separadores, dobles
 Ecarteurs doubles
 Divaricatori, doppi

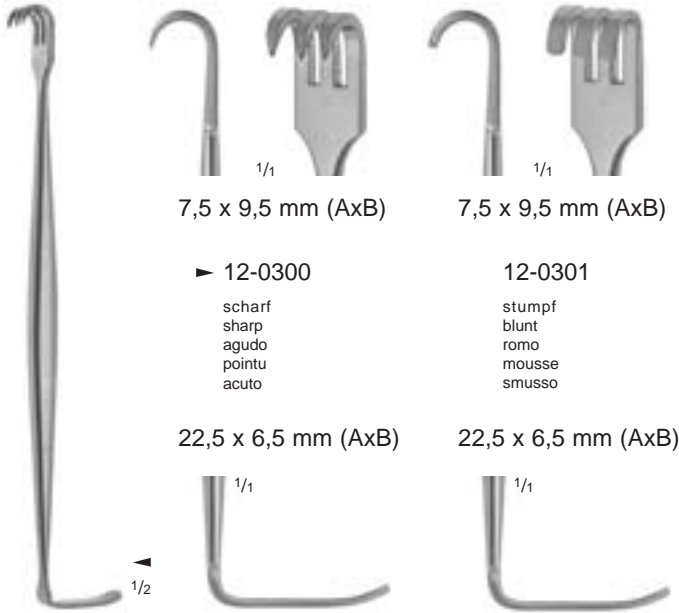
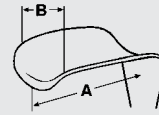

7,5 x 9,5 mm (AxB)

7,5 x 9,5 mm (AxB)

▶ 12-0300

scharf
sharp
agudo
pointu
acuto

12-0301

stumpf
blunt
romo
mousse
smusso

22,5 x 6,5 mm (AxB)

22,5 x 6,5 mm (AxB)

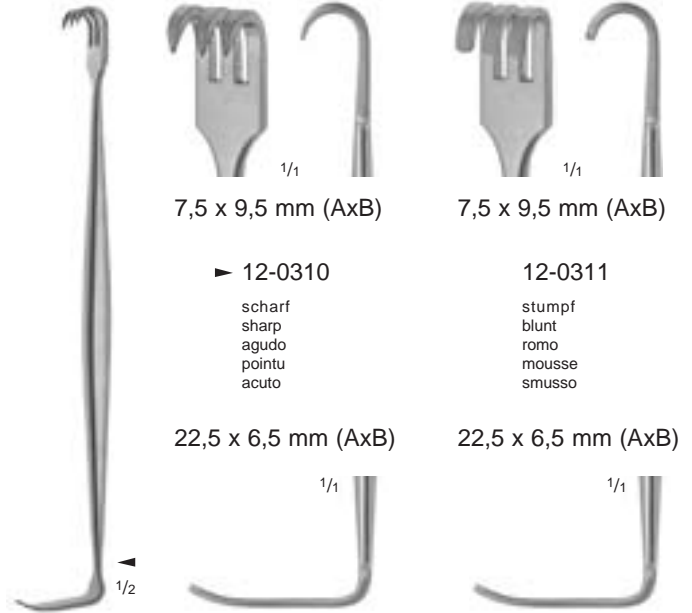

7,5 x 9,5 mm (AxB)

7,5 x 9,5 mm (AxB)

▶ 12-0310

scharf
sharp
agudo
pointu
acuto

12-0311

stumpf
blunt
romo
mousse
smusso

22,5 x 6,5 mm (AxB)

22,5 x 6,5 mm (AxB)

SENN-MILLER
12-0300
- 12-0301
16 cm, 6 1/4"

MATHIEU
12-0310
- 12-0311
16 cm, 6 1/4"

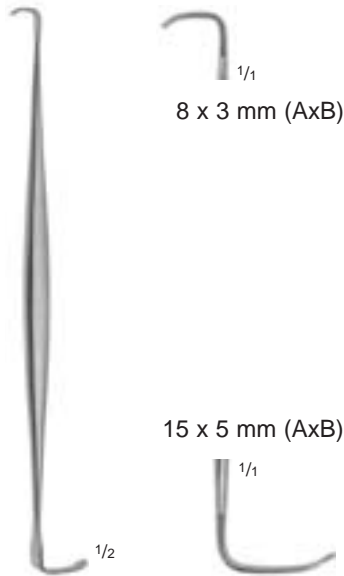

8 x 3 mm (AxB)

15 x 5 mm (AxB)

RAGNELL-DAVIS
75-0620
15 cm, 6"

Haken für plastische Chirurgie
Hook for plastic surgery
Gancho para cirugía plástica
Ecarteur pour la chirurgie plastique
Divaricatore per chirurgia plastica

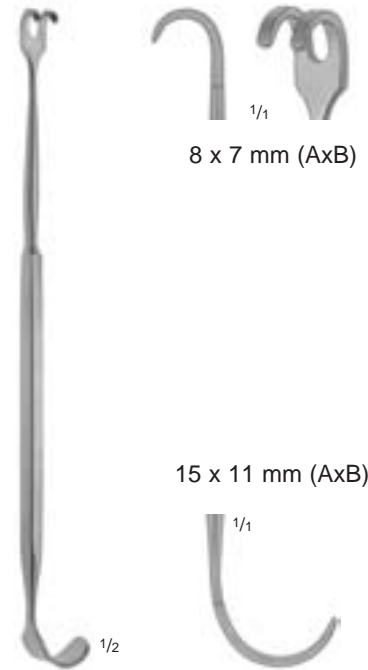

8 x 7 mm (AxB)

15 x 11 mm (AxB)

JACKSON
87-0200
17,5 cm, 7"

Tracheal-Haken
Trachea retractor
Separador para la tráquea
Ecarteur pour la trachée
Divaricatore per trachea

Wundhaken, doppelendig
 Retractors, double-ended
 Separadores, dobles
 Ecarteurs doubles
 Divaricatori, doppi

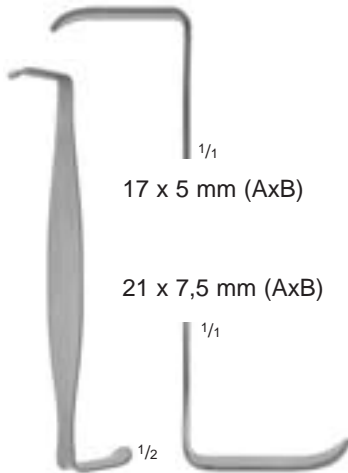
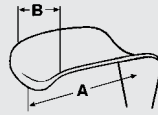

$17 \times 5 \text{ mm (AxB)}$
 $21 \times 7,5 \text{ mm (AxB)}$

CRILE
 12-0350
 10,5 cm, 4 1/8"

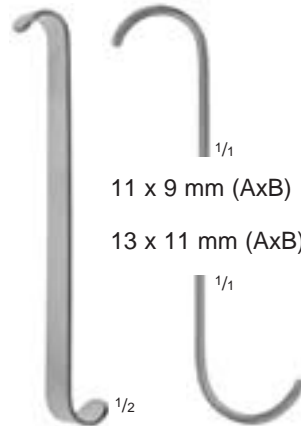

$11 \times 9 \text{ mm (AxB)}$
 $13 \times 11 \text{ mm (AxB)}$

LUER
 12-0352
 11 cm, 4 3/8"

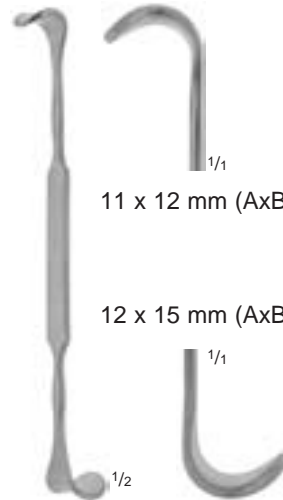

$11 \times 12 \text{ mm (AxB)}$
 $12 \times 15 \text{ mm (AxB)}$

ROSE
 12-0354
 13 cm, 5 1/8"

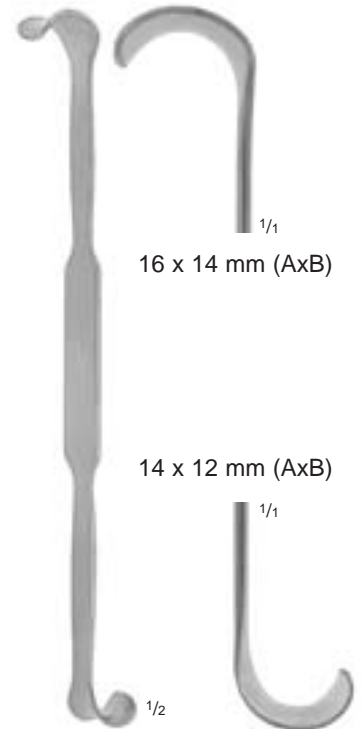

$16 \times 14 \text{ mm (AxB)}$
 $14 \times 12 \text{ mm (AxB)}$

ROSE
 12-0355
 19 cm, 7 1/2"

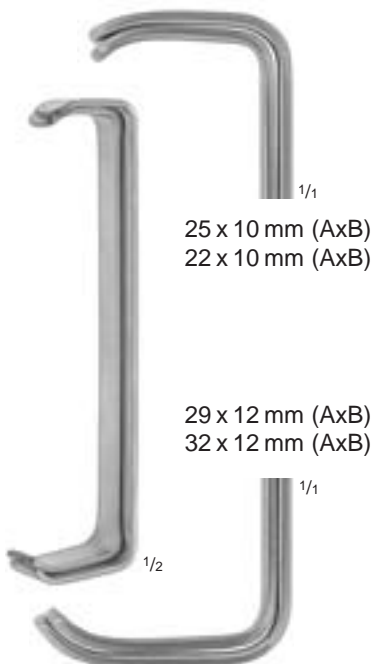

$25 \times 10 \text{ mm (AxB)}$
 $22 \times 10 \text{ mm (AxB)}$
 $29 \times 12 \text{ mm (AxB)}$
 $32 \times 12 \text{ mm (AxB)}$

FARABEUF
 20-0431
 12,5 cm, 5"
 Satz • Set • Juego • Jeu • Serie

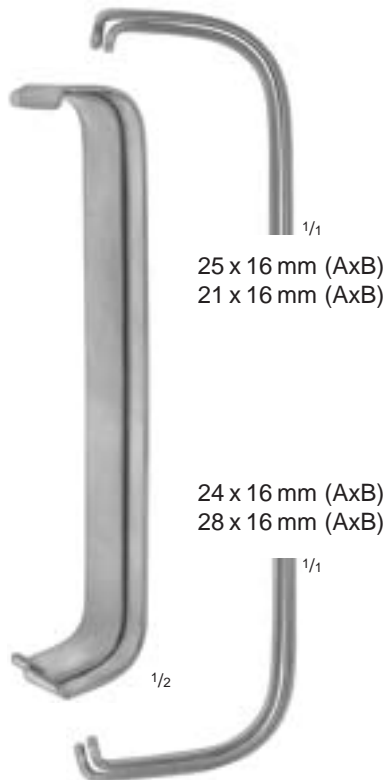

$25 \times 16 \text{ mm (AxB)}$
 $21 \times 16 \text{ mm (AxB)}$
 $24 \times 16 \text{ mm (AxB)}$
 $28 \times 16 \text{ mm (AxB)}$

FARABEUF
 20-0430
 15,5 cm, 6"
 Satz • Set • Juego • Jeu • Serie

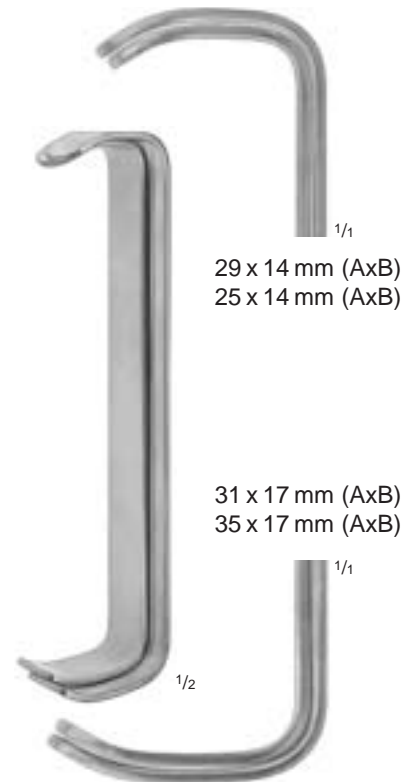

$29 \times 14 \text{ mm (AxB)}$
 $25 \times 14 \text{ mm (AxB)}$
 $31 \times 17 \text{ mm (AxB)}$
 $35 \times 17 \text{ mm (AxB)}$

COLLIN
 20-0402
 14,5 cm, 5 3/4"
 Satz • Set • Juego • Jeu • Serie



Wundhaken, doppelendig
 Retractors, double-ended
 Separadores, dobles
 Ecarteurs doubles
 Divaricatori, doppi

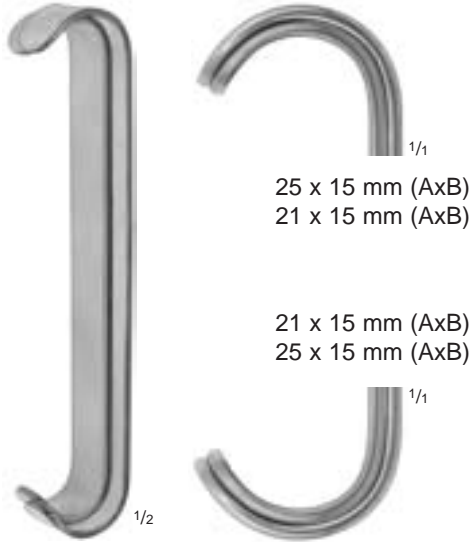
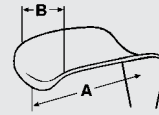

^{1/1}
 25 x 15 mm (AxB)
 21 x 15 mm (AxB)

21 x 15 mm (AxB)
 25 x 15 mm (AxB)

^{1/2}
PARKER
 20-0460
 14 cm, 5 1/2"

Satz • Set • Juego • Jeu • Serie

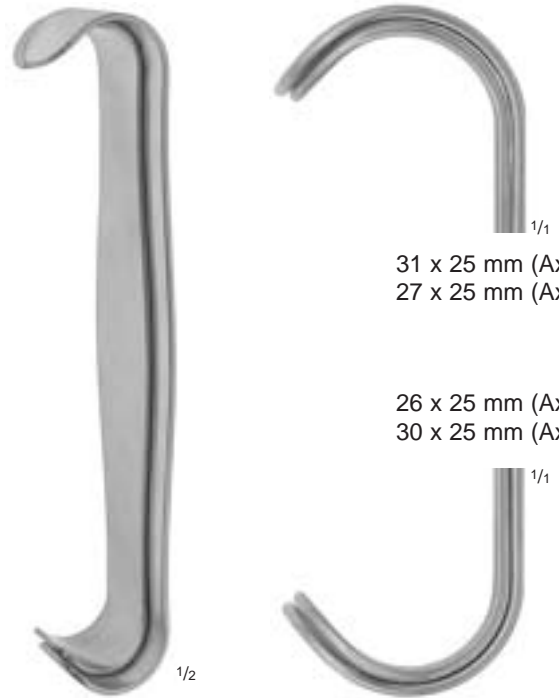

^{1/1}
 31 x 25 mm (AxB)
 27 x 25 mm (AxB)

26 x 25 mm (AxB)
 30 x 25 mm (AxB)

^{1/2}
PARKER
 20-0465
 18 cm, 7"

Satz • Set • Juego • Jeu • Serie

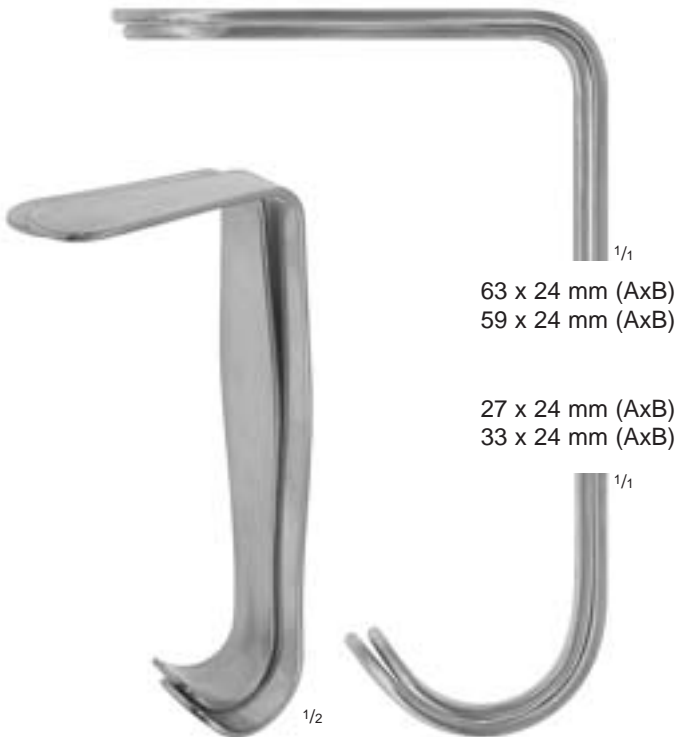

^{1/1}
 63 x 24 mm (AxB)
 59 x 24 mm (AxB)

27 x 24 mm (AxB)
 33 x 24 mm (AxB)

^{1/2}
PARKER-MOTT
 20-0470
 14,5 cm, 5 3/4"

Satz • Set • Juego • Jeu • Serie

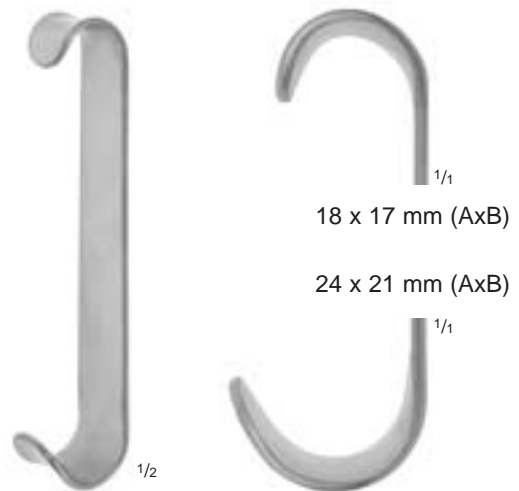

^{1/1}
 18 x 17 mm (AxB)

24 x 21 mm (AxB)

^{1/2}
BABY-ROUX
 20-0415
 12,5 cm, 5"

Wundhaken, doppelendig
 Retractors, double-ended
 Separadores, dobles
 Ecarteurs doubles
 Divaricatori, doppi

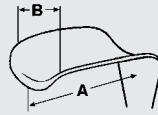

ROUX
 ▶ 20-0410
 17 cm, 6³/₄"

Satz, Fig. 1 - 3 • Set, fig. 1 - 3 • Juego, fig. 1 - 3 • Jeu, fig. 1 - 3 • Serie, fig. 1 - 3



21 x 24 mm (AxB)

20-0411
 14,5 cm, 5³/₄"

29 x 28 mm (AxB)



Fig. 1



27 x 26 mm (AxB)

20-0412
 15,5 cm, 6"

32 x 37 mm (AxB)



Fig. 2



31 x 30 mm (AxB)

20-0413
 17 cm, 6³/₄"

36 x 42 mm (AxB)



Fig. 3



COLLIN - HARTMANN
 20-0406
 15,5 cm, 6"

35 x 29 mm (AxB)

50 x 35 mm (AxB)



GOELET
 20-0490
 19 cm, 7¹/₂"



35 x 40 mm (AxB)

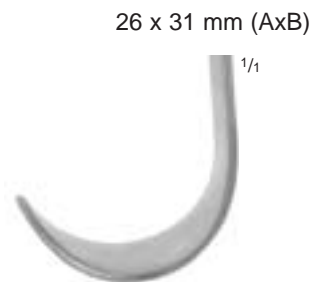

26 x 31 mm (AxB)



Wundhaken, doppelendig
Retractors, double-ended
Separadores, dobles
Ecarteurs doubles
Divaricatori, doppi

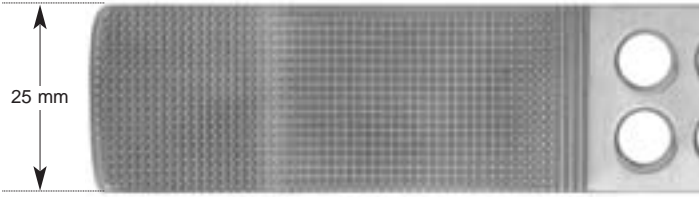

25 mm

20-0440
125 / 175 x 25 mm

1/1

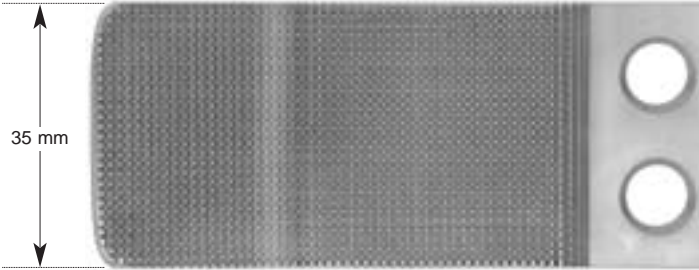

35 mm

▶ 20-0442
125 / 175 x 35 mm

1/1

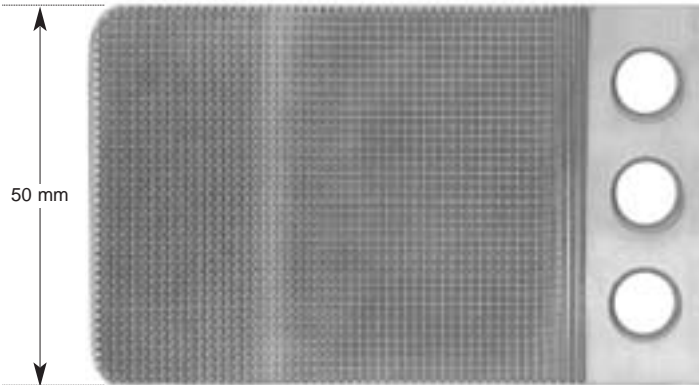

50 mm

20-0444
125 / 175 x 50 mm

1/1

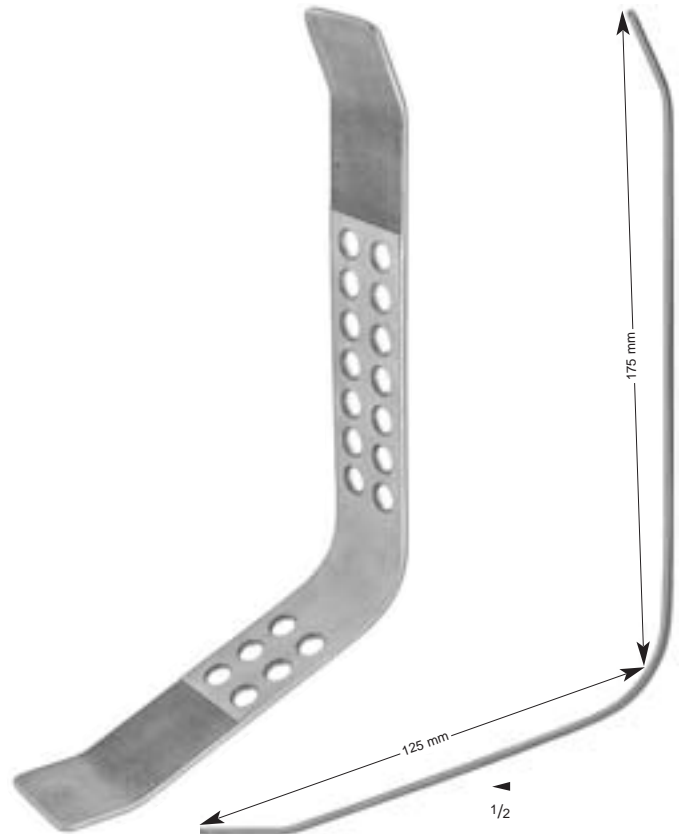

THORLAKSON
20-0440
- 20-0444
25 cm, 10"

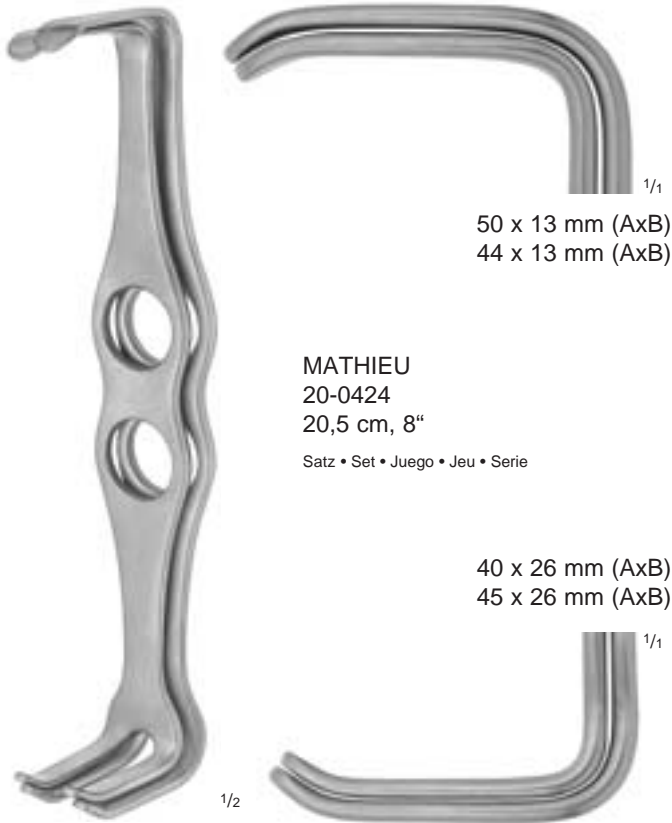
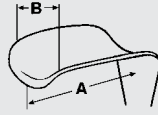

MATHIEU
 20-0424
 20,5 cm, 8"
 Satz • Set • Juego • Jeu • Serie

50 x 13 mm (AxB)
 44 x 13 mm (AxB)

40 x 26 mm (AxB)
 45 x 26 mm (AxB)

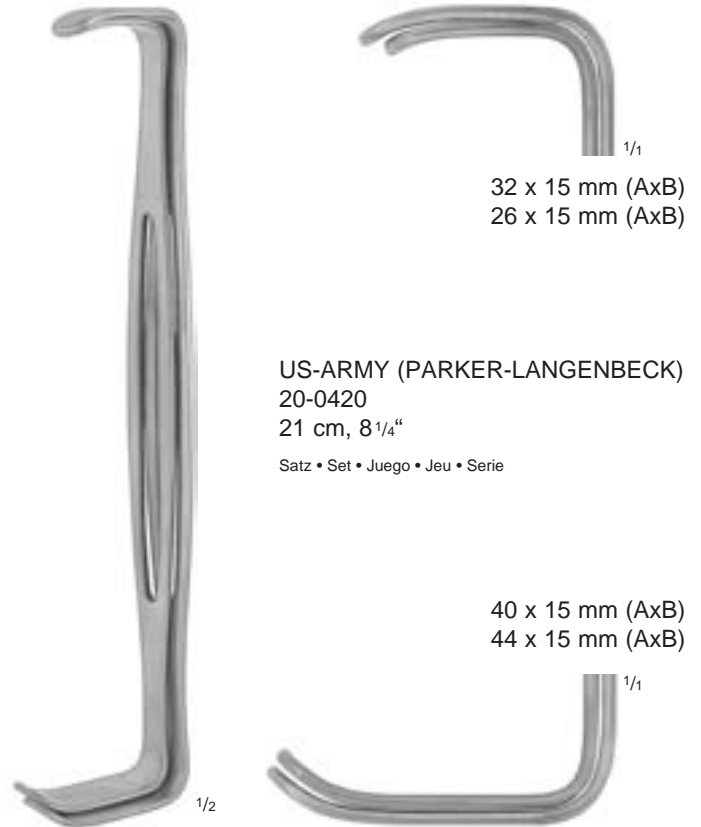

US-ARMY (PARKER-LANGENBECK)
 20-0420
 21 cm, 8 1/4"
 Satz • Set • Juego • Jeu • Serie

32 x 15 mm (AxB)
 26 x 15 mm (AxB)

40 x 15 mm (AxB)
 44 x 15 mm (AxB)

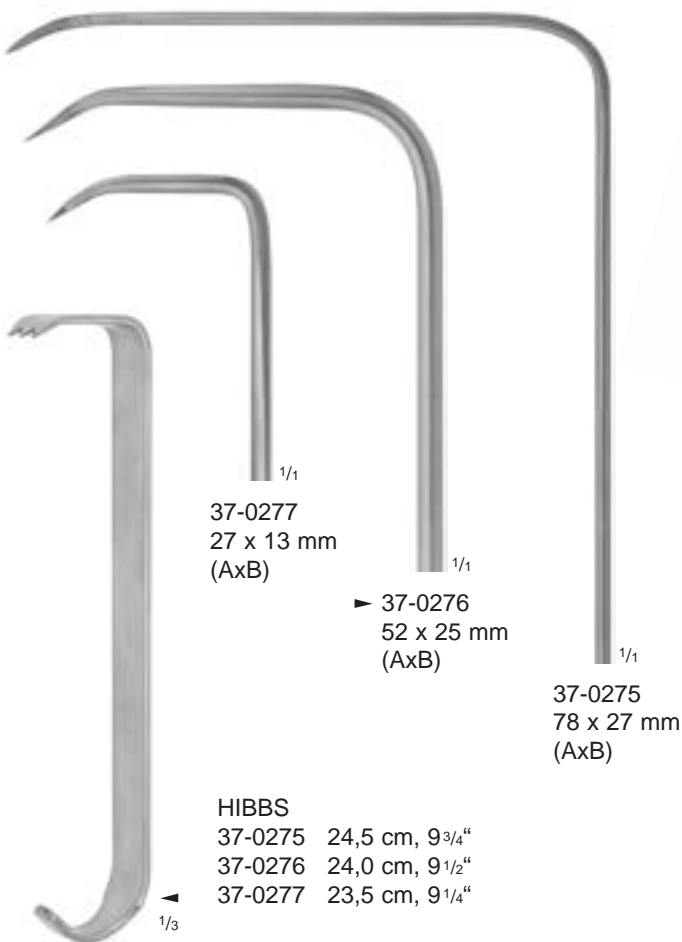

37-0277
 27 x 13 mm
 (AxB)

▶ 37-0276
 52 x 25 mm
 (AxB)

37-0275
 78 x 27 mm
 (AxB)

HIBBS
 37-0275 24,5 cm, 9 3/4"
 37-0276 24,0 cm, 9 1/2"
 37-0277 23,5 cm, 9 1/4"

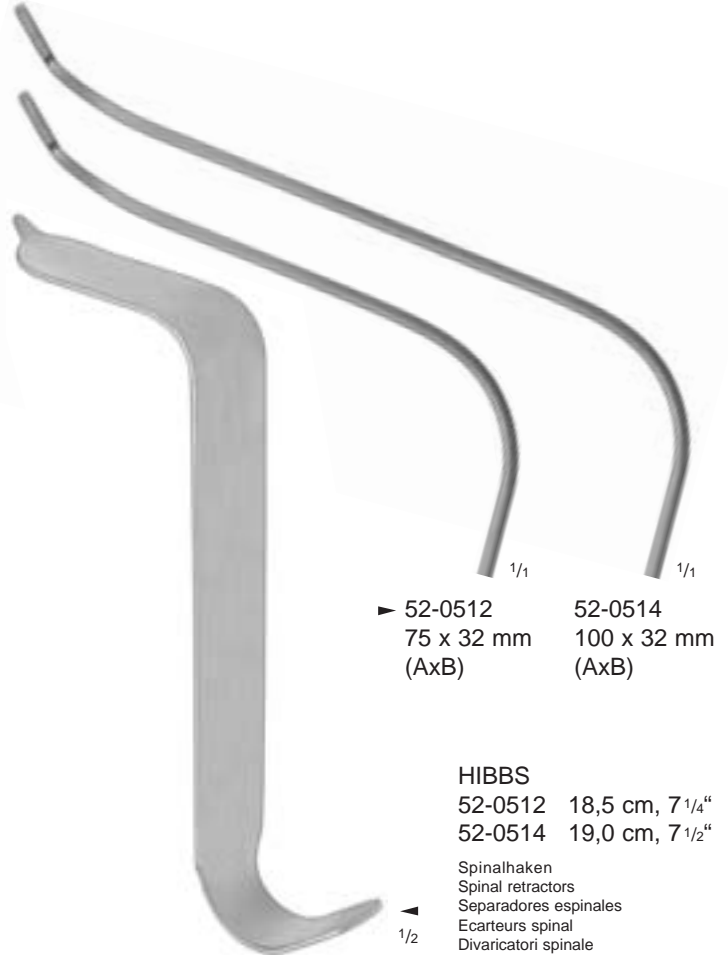

▶ 52-0512
 75 x 32 mm
 (AxB)

52-0514
 100 x 32 mm
 (AxB)

HIBBS
 52-0512 18,5 cm, 7 1/4"
 52-0514 19,0 cm, 7 1/2"

Spinalhaken
 Spinal retractors
 Separadores espinales
 Ecarteurs spinal
 Divaricatori spinale



Wund- und Knochenhaken
 Retractors and Bone Retractors
 Separadores y separadores para huesos
 Ecarteurs et Ecarteurs à os
 Divaricatori e Divaricatori per ossa



1/2

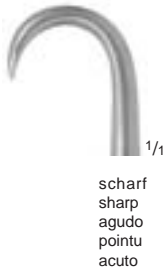

1/1

scharf
 sharp
 agudo
 pointu
 acuto

KOCHER
 20-0280
 20 cm, 8"



1/2



1/1

▶ 20-0281
 22 cm, 8^{3/4}"
 scharf
 sharp
 agudo
 pointu
 acuto



1/1

20-0290
 22 cm, 8^{3/4}"
 stumpf
 blunt
 romo
 mousse
 smusso

KOCHER
 20-0281
 - 20-0290



1/2



1/1

▶ 20-0300
 22 cm, 8^{3/4}"
 scharf
 sharp
 agudo
 pointu
 acuto



1/1

20-0310
 22 cm, 8^{3/4}"
 stumpf
 blunt
 romo
 mousse
 smusso

VOLKMANN
 20-0300
 - 20-0310



1/2



1/1

▶ 20-0220
 22 cm, 8^{3/4}"
 scharf
 sharp
 agudo
 pointu
 acuto



1/1

20-0230
 22 cm, 8^{3/4}"
 stumpf
 blunt
 romo
 mousse
 smusso

VOLKMANN
 20-0220
 - 20-0230

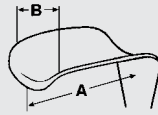

20-0221
 10 x 8 mm (AxB)



20-0231
 10 x 8 mm (AxB)



20-0222
 10 x 13 mm (AxB)



20-0232
 10 x 13 mm (AxB)



VOLKMANN
 20-0221
 - 20-0234
 23 cm, 9"



20-0223
 10 x 18 mm (AxB)



20-0233
 10 x 18 mm (AxB)



▶ 20-0224
 10 x 28 mm (AxB)



20-0234
 10 x 28 mm (AxB)

scharf
 sharp
 agudo
 pointu
 acuto

stumpf
 blunt
 romo
 mousse
 smusso



Wundhaken
Retractors
Separadores
Ecarteurs
Divaricatori

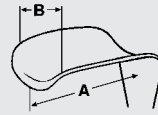

20-0302
10 x 8 mm (AxB)



20-0352
10 x 8 mm (AxB)



20-0312
10 x 8 mm (AxB)



20-0303
10 x 13 mm (AxB)



20-0353
10 x 13 mm (AxB)



20-0313
10 x 13 mm (AxB)



20-0304
10 x 18 mm (AxB)



20-0354
10 x 18 mm (AxB)



20-0314
10 x 18 mm (AxB)



▶ 20-0306
10 x 28 mm (AxB)



20-0356
10 x 28 mm (AxB)



20-0316
10 x 28 mm (AxB)



20-0308
10 x 40 mm (AxB)



20-0318
10 x 40 mm (AxB)



VOLKMANN
20-0302
- 20-0356
22,5 cm, 9"

scharf
sharp
agudo
pointu
acuto

halbscharf
semi-sharp
semi-agudo
semi-pointu
semi acuto

stumpf
blunt
romo
mousse
smusso

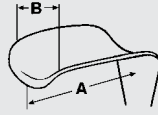

20-0282
15 x 9 mm (Ax B)



20-0272
15 x 9 mm (Ax B)



20-0292
15 x 9 mm (Ax B)



20-0283
15 x 13 mm (Ax B)



20-0273
15 x 13 mm (Ax B)



20-0293
15 x 13 mm (Ax B)



KOCHER
20-0272
- 20-0296
22,5 cm, 9"



20-0284
15 x 18 mm (Ax B)



20-0274
15 x 18 mm (Ax B)



20-0294
15 x 18 mm (Ax B)



20-0286
15 x 30 mm (Ax B)



20-0276
15 x 30 mm (Ax B)



20-0296
15 x 30 mm (Ax B)

scharf
sharp
agudo
pointu
acuto

halbscharf
semi-sharp
semi-agudo
semi-pointu
semi acuto

stumpf
blunt
romo
mousse
smusso



Wundhaken
Retractors
Separadores
Ecarteurs
Divaricatori

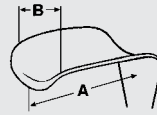

20-0750
26 x 39 mm (AxB)
scharf
sharp
agudo
pointu
acuto

KOERTE
20-0750
- 20-0751
24 cm, 9 1/2"

Griff vertikal zum Blatt
handle vertical to the blade
mango vertical a la hoja
manche vertical à la valve
impugnatura verticale a lama

1/2



20-0751
26 x 39 mm (AxB)
stumpf
blunt
romo
mousse
smusso



25 x 60 mm (AxB)

20-0753
25 cm, 10"
scharf
sharp
agudo
pointu
acuto

1/2



38 x 56 mm (AxB)

OLLIER
20-0760
23 cm, 9"

1/2



46 x 55 mm (AxB)

KOERTE
20-0754
24 cm, 9 1/2"

1/2

Griff vertikal zum Blatt
handle vertical to the blade
mango vertical a la hoja
manche vertical à la valve
impugnatura verticale a lama

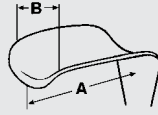

20-0774
 40 x 40 mm (AxB)



▶ 20-0775
 47 x 50 mm (AxB)



20-0776
 53 x 60 mm (AxB)



20-0777
 70 x 70 mm (AxB)

ISRAEL
 20-0774
 - 20-0777
 24,5 cm, 9³/₄"



Wundhaken
Retractors
Separadores
Ecarteurs
Divaricatori

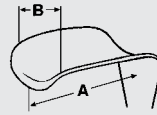

20-0530
30 x 10 mm (AxB)



▶ 20-0534
30 x 14 mm (AxB)



20-0535
30 x 16 mm (AxB)



20-0531
40 x 10 mm (AxB)



20-0532
42 x 13 mm (AxB)



20-0533
40 x 15 mm (AxB)



20-0536
50 x 11 mm (AxB)

LANGENBECK
20-0530
- 20-0536
21,5 cm, 8 1/2"



20-0551
30 x 10 mm (AxB)



▶ 20-0552
30 x 14 mm (AxB)



20-0553
30 x 16 mm (AxB)



20-0555
40 x 10 mm (AxB)



20-0561
42 x 13 mm (AxB)



20-0556
40 x 15 mm (AxB)



20-0562
50 x 11 mm (AxB)

LANGENBECK
20-0551
- 20-0562
21 cm, 8 1/4"

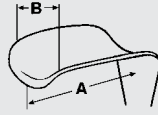

▶ 20-0557
 55 x 20 mm (AxB)



20-0558
 60 x 20 mm (AxB)



LANGENBECK
 20-0557 22,5 cm, 9"
 20-0558 21,5 cm, 8 1/2"

85 x 15 mm (AxB)

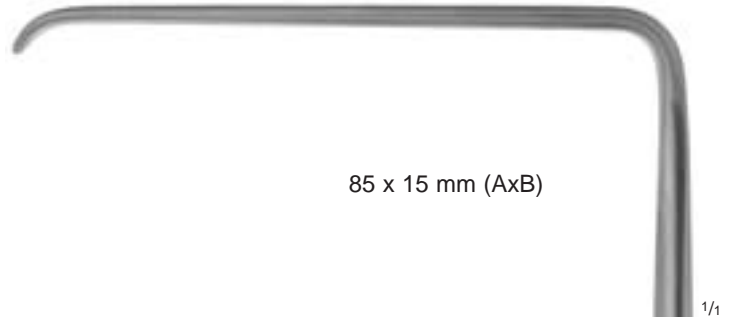

LANGENBECK
 20-0559
 21,5 cm, 8 1/2"



Wundhaken
Retractors
Separadores
Ecarteurs
Divaricatori

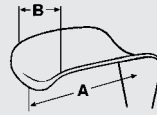

KOCHER-LANGENBECK
20-0570
- 20-0583
21,5 cm, 8 1/2"



20-0570
25 x 6 mm (Ax B)



20-0571
35 x 8 mm (Ax B)



20-0572
35 x 11 mm (Ax B)



20-0583
35 x 15 mm (Ax B)



▶ 20-0581
40 x 11 mm (Ax B)



20-0582
55 x 11 mm (Ax B)



20-0573
70 x 14 mm (Ax B)



20-0574
80 x 12 mm (Ax B)



20-0575
80 x 16 mm (Ax B)

Wundhaken
 Retractors
 Separadores
 Ecarteurs
 Divaricatori

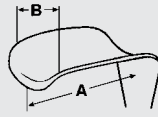

Weichteilhaken
 Soft tissue retractors
 Separadores para tejido blando
 Ecarteurs pour parties molles
 Divaricatori per tessuti molli

OBWEGESER
20-0507
 - **20-0512**
 22 cm, 8³/₄"

1/2

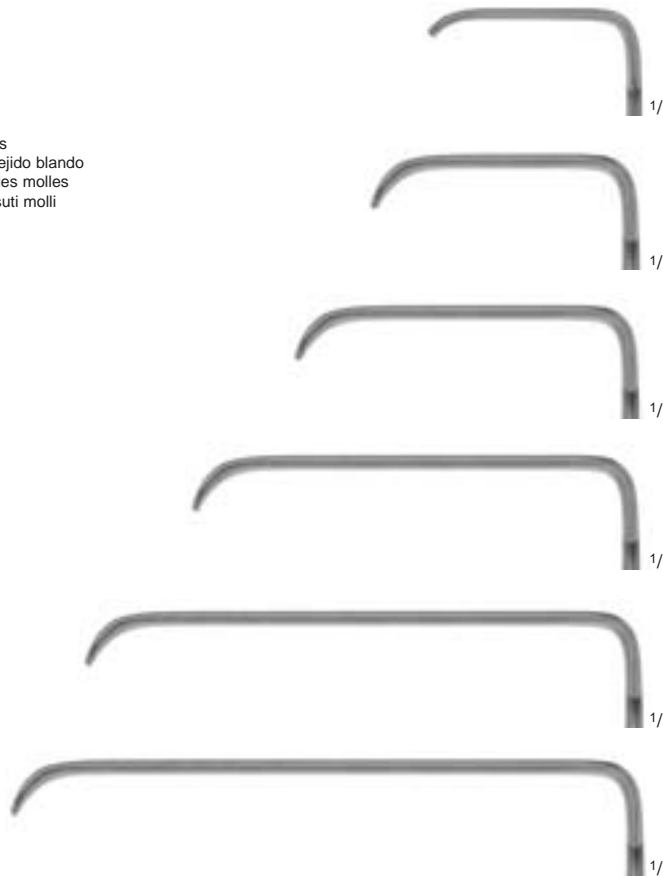

► **20-0507**
 25 x 7 mm (AxB)

1/1

20-0508
 31 x 10 mm (AxB)

1/1

20-0509
 42 x 11 mm (AxB)

1/1

20-0510
 55 x 12 mm (AxB)

1/1

20-0511
 70 x 14 mm (AxB)

1/1

20-0512
 80 x 16 mm (AxB)

1/1



Weichteilhaken
 Soft tissue retractors
 Separadores para tejido blando
 Ecarteurs pour parties molles
 Divaricatori per tessuti molli

OBWEGESER
20-0514
 - **20-0519**
 22 cm, 8³/₄"

1/2

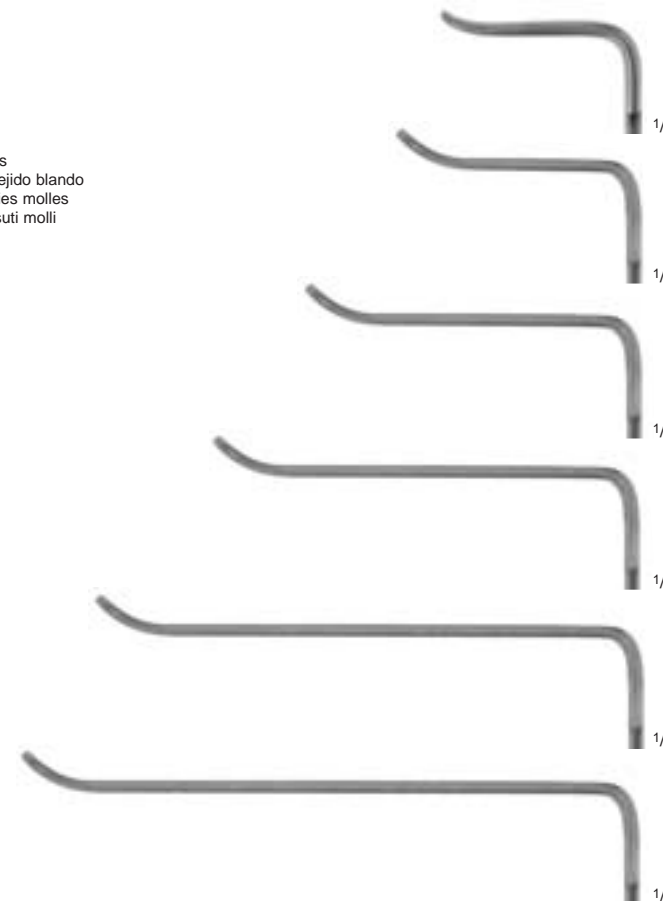

► **20-0514**
 25 x 7 mm (AxB)

1/1

20-0515
 31 x 10 mm (AxB)

1/1

20-0516
 42 x 11 mm (AxB)

1/1

20-0517
 55 x 12 mm (AxB)

1/1

20-0518
 70 x 14 mm (AxB)

1/1

20-0519
 80 x 16 mm (AxB)

1/1



Wundhaken
Retractors
Separadores
Ecarteurs
Divaricatori

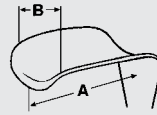

KOCHER
20-0584
- 20-0589
23 cm, 9"

1/2



▶ 20-0585
40 x 18 mm (AxB)

1/1



20-0584
60 x 20 mm (AxB)

1/1



20-0586
60 x 25 mm (AxB)

1/1



20-0589
75 x 30 mm (AxB)

1/1



20-0587
75 x 40 mm (AxB)

1/1



SAUERBRUCH
20-0641
- 20-0643
23 cm, 9"

1/2



20-0641
46 x 16 mm (AxB)

1/1



▶ 20-0642
55 x 22 mm (AxB)

1/1



20-0643
72 x 19 mm (AxB)

1/1

Wundhaken
Retractors
Separadores
Ecarteurs
Divaricatori

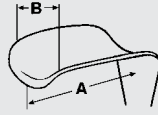

22 X 20 mm (AxB)



GREEN
12-0330
23 cm, 9"

Schilddrüsenhaken
Thyroid gland retractor
Separador para la glándula tiroidea
Ecarteur pour la thyroïde
Divaricatore per la tiroide



▶ **20-0626**
26 x 30 mm (AxB)



20-0625
20 x 22 mm (AxB)



20-0624
15 x 16 mm (AxB)

MIDDELDORPF
20-0624 21,5 cm, 8 1/2"
20-0625 22,5 cm, 9"
20-0626 23,5 cm, 9 1/4"



20-0629
55 x 70 mm (AxB)



▶ **20-0628**
45 x 50 mm (AxB)



20-0627
45 x 45 mm (AxB)

MIDDELDORPF
20-0627
- **20-0629**
27,5 cm, 10 3/4"



Wundhaken
Retractors
Separadores
Ecarteurs
Divaricatori

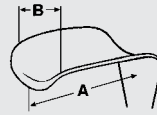

20-0607 19 x 12 mm (AxB)



20-0608 21 x 15 mm (AxB)



► **20-0618** 40 x 10 mm (AxB)
20-0619 40 x 15 mm (AxB)
20-0620 40 x 20 mm (AxB)

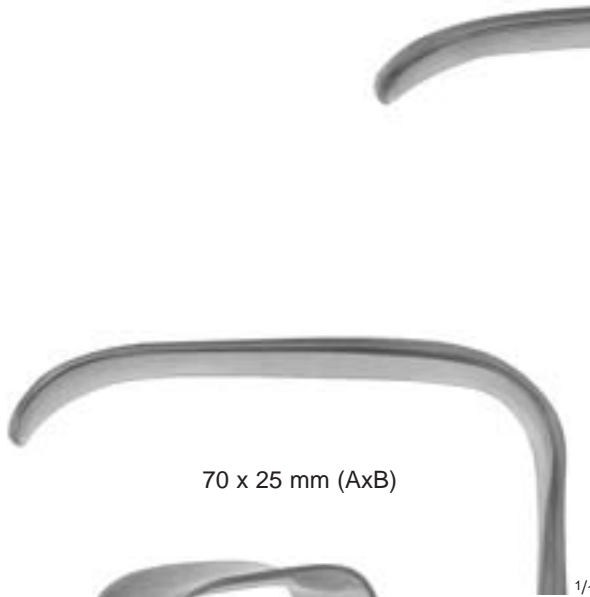

70 x 25 mm (AxB)



► **20-0615** 80 x 42 mm (AxB)
20-0616 80 x 50 mm (AxB)
20-0617 80 x 55 mm (AxB)
20-0635 80 x 65 mm (AxB)



KOCHER
20-0607
- **20-0620**
22,5 cm, 9"



KOCHER
20-0614
23 cm, 9"



KOCHER
20-0615
- **20-0635**
24,5 cm, 9³/₄"

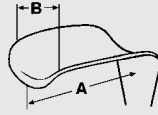

► **20-0636**
40 x 12 mm (AxB)



20-0637
55 x 14 mm (AxB)

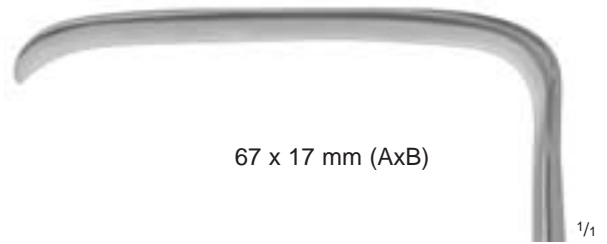

67 x 17 mm (AxB)



DOCKHORN
20-0636
- **20-0637**
21 cm, 8 1/4"



CASPAR
20-0638
22,5 cm, 9"



Wundhaken
Retractors
Separadores
Ecarteurs
Divaricatori

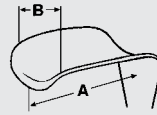

20-0644
60 x 20 mm (AxB)

20-0645
80 x 30 mm (AxB)

20-0646
100 x 30 mm (AxB)

▶ **20-0647**
120 x 30 mm (AxB)

20-0648 140 x 30 mm (AxB)
20-0649 140 x 40 mm (AxB)



HÖSEL
20-0644
- **20-0649**
25 cm, 10"

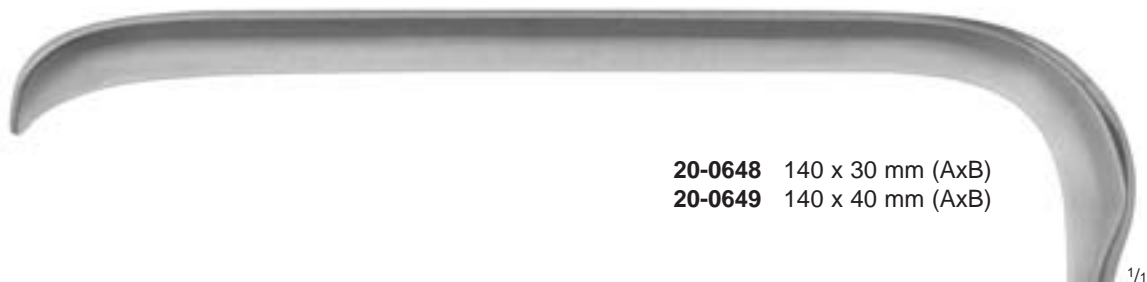

Wundhaken
 Retractors
 Separadores
 Ecarteurs
 Divaricatori

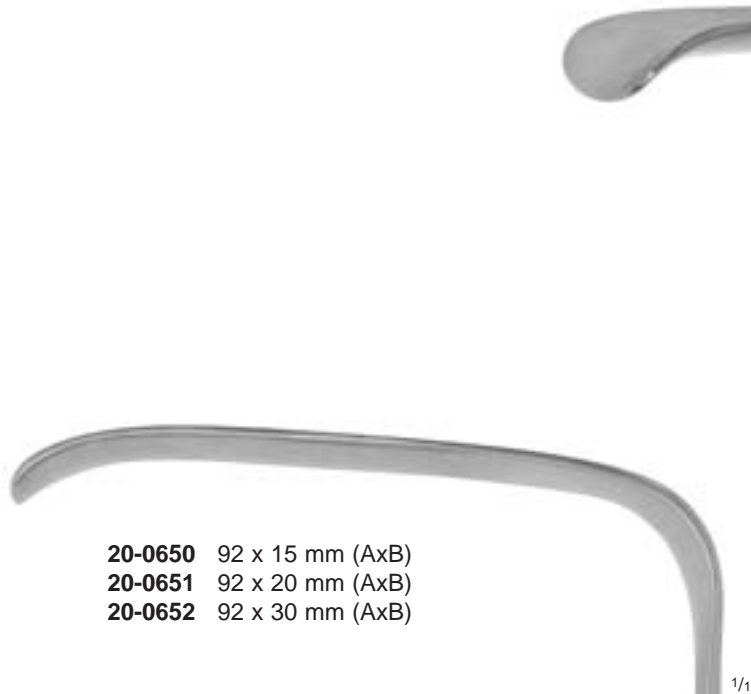
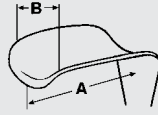

20-0650 92 x 15 mm (AxB)
20-0651 92 x 20 mm (AxB)
20-0652 92 x 30 mm (AxB)

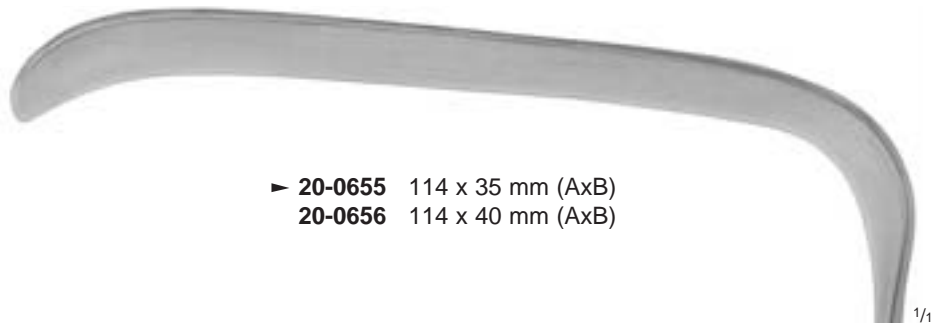

▶ **20-0655** 114 x 35 mm (AxB)
20-0656 114 x 40 mm (AxB)



20-0659 120 x 55 mm (AxB)

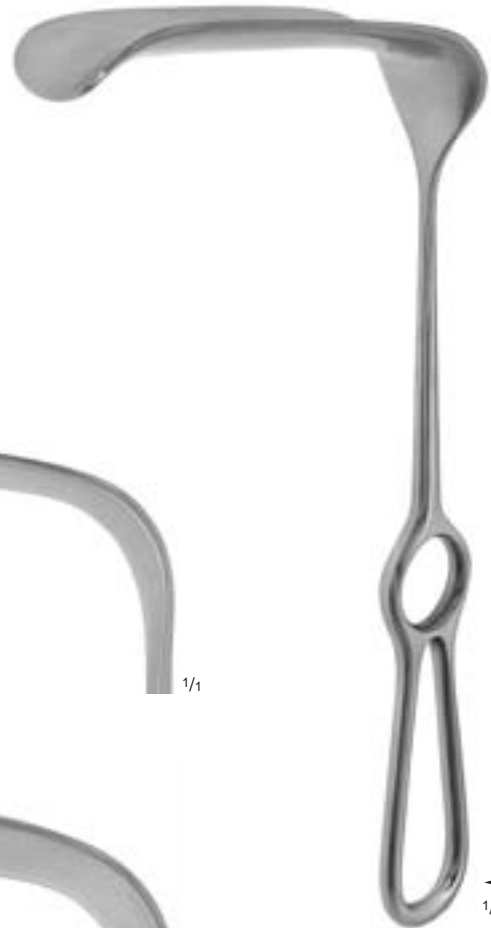

DOYEN-STILLE

20-0650

- **20-0659**

24 cm, 9 1/2"

Griff vertikal zum Blatt
 handle vertical to the blade
 mango vertical a la hoja
 manche vertical à la valve
 impugnatura verticale a lama



Wundhaken
Retractors
Separadores
Ecarteurs
Divaricatori

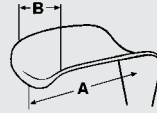

DOYEN
20-0680
- **20-0699**
23 cm, 9"

Bauchdeckenhaken
Abdominal retractors
Separadores abdominales
Ecarteurs intra abdominaux
Divaricatori addominale

- **20-0680** 55 x 35 mm (AxB)
20-0683 55 x 45 mm (AxB)
20-0686 55 x 60 mm (AxB)



- 20-0681** 85 x 35 mm (AxB)
20-0684 85 x 45 mm (AxB)
20-0687 85 x 60 mm (AxB)



- 20-0682** 115 x 35 mm (AxB)
20-0685 115 x 45 mm (AxB)
20-0688 115 x 60 mm (AxB)



- 20-0689** 160 x 45 mm (AxB)
20-0699 160 x 60 mm (AxB)

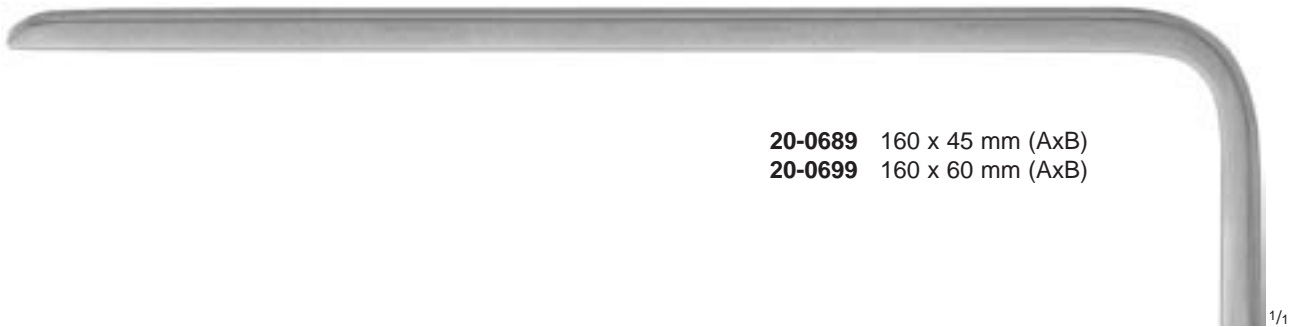

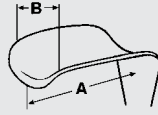

50 x 85 mm (AxB)

1/1



1/2

DOYEN
20-0665
24 cm, 9 1/2"

Bauchdeckenhaken
Abdominal retractor
Separador abdominal
Ecarteur intra abdominaux
Divaricatore addominale

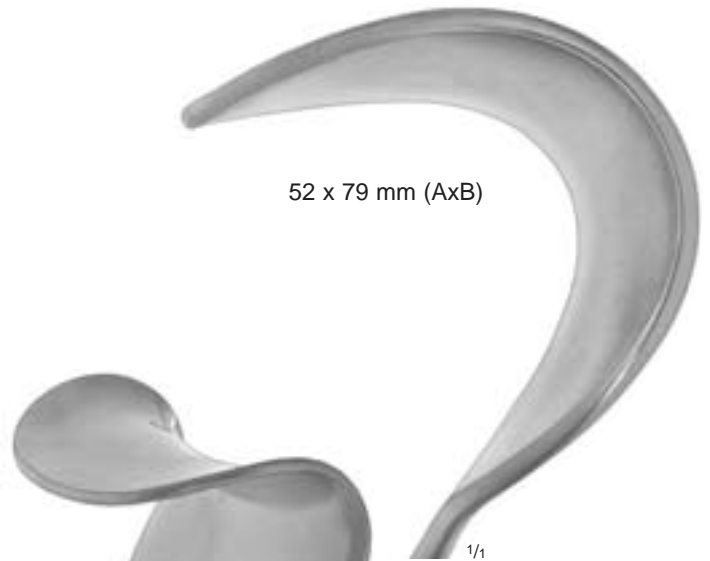

52 x 79 mm (AxB)

1/1



1/2

MAYO
20-1730
27,5 cm, 10 3/4"

Bauchdeckenhaken
Abdominal retractor
Separador abdominal
Ecarteur intra abdominaux
Divaricatore addominale



Wundhaken
Retractors
Separadores
Ecarteurs
Divaricatori

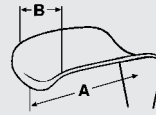

20-0735
60 x 85 mm (AxB)



20-0734
45 x 75 mm (AxB)

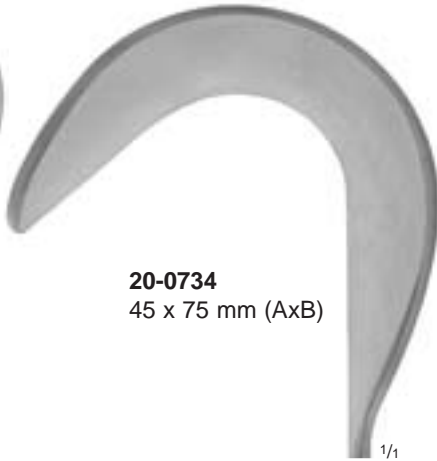

20-0732 40 x 50 mm (AxB)
▶ **20-0733** 40 x 60 mm (AxB)

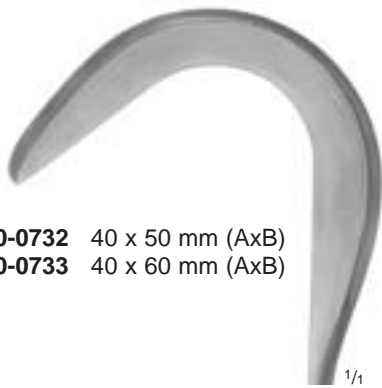

20-0731
35 x 40 mm (AxB)

FRITSCH

- 20-0731** 23,5 cm, 9 1/4"
- 20-0732** 24,5 cm, 9 3/4"
- 20-0733** 24,5 cm, 9 3/4"
- 20-0734** 25,0 cm, 10"
- 20-0735** 26,0 cm, 10 1/4"

Griff vertikal zum Blatt
handle vertical to the blade
mango vertical a la hoja
manche vertical à la valve
impugnatura verticale a lama

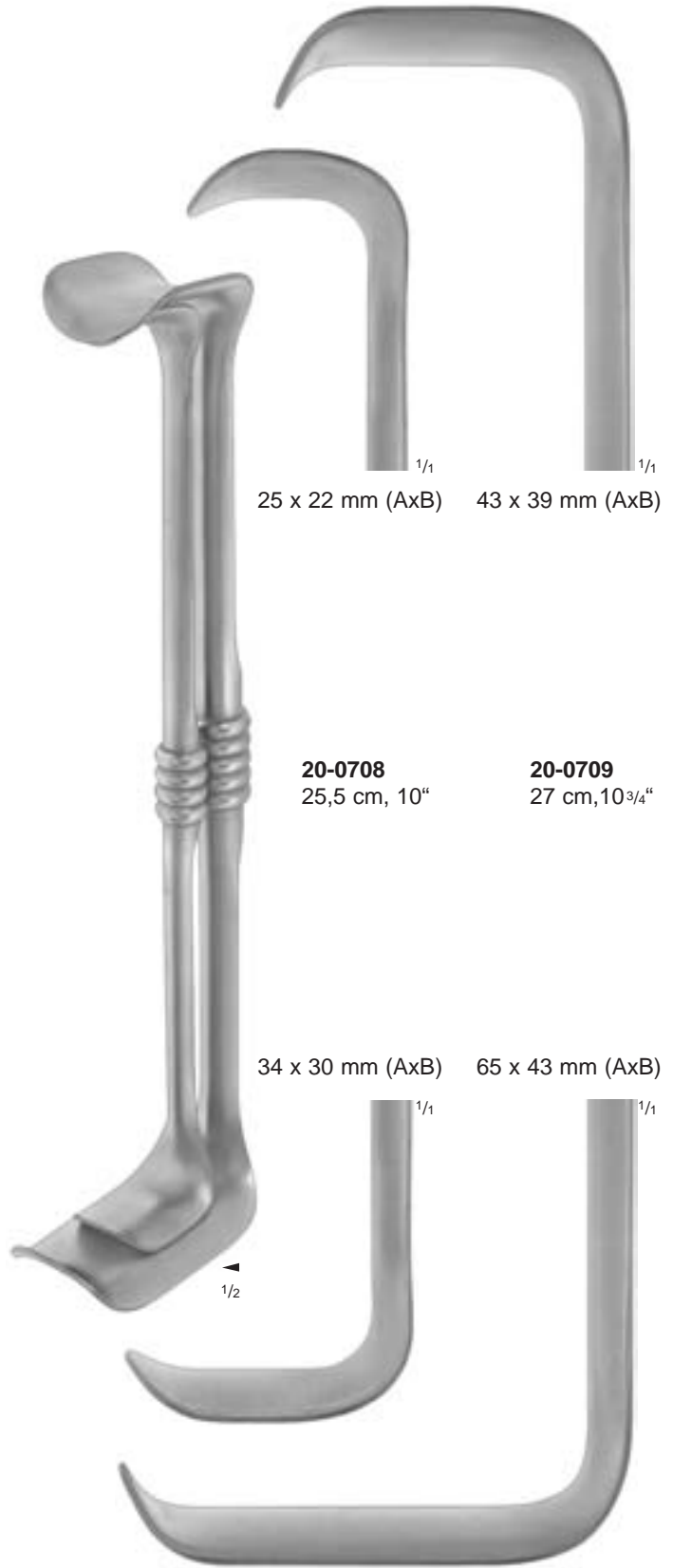

20-0708
25 x 22 mm (AxB)

20-0709
43 x 39 mm (AxB)

20-0708
25,5 cm, 10"

20-0709
27 cm, 10 3/4"

20-0710
34 x 30 mm (AxB)

20-0710
65 x 43 mm (AxB)

RICHARDSON-EASTMAN

▶ **20-0710**
27 cm, 10 3/4"

Satz • Set • Juego • Jeu • Serie

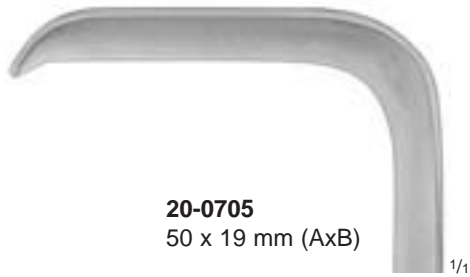
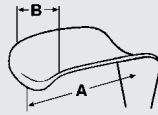

RICHARDSON
20-0705
 - **20-0713**
 24 cm, 9 1/2"

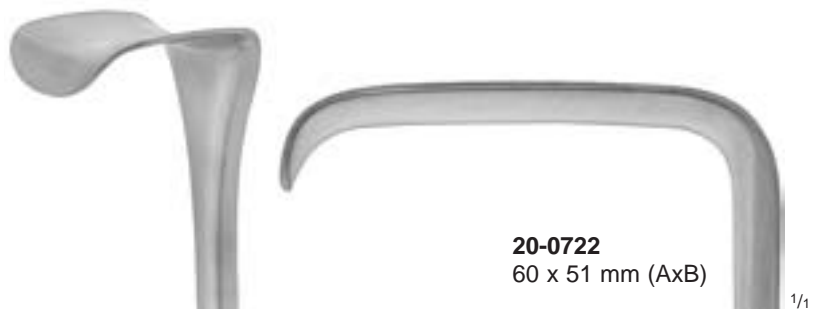

KELLY
20-0721 23,5 cm, 9 1/4"
20-0722 24,0 cm, 9 1/2"
20-0723 25,0 cm, 10"



Wundhaken für Eingriffe in der Tiefe

Retractors for Deep Surgery

Separadores para cirugía profunda

Ecarteurs pour interventions en profondeur

Divaricatori per interventi in profondità

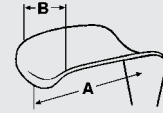

20-0742 180 x 30 mm (AxB)

20-0743 160 x 30 mm (AxB)

20-0744 140 x 30 mm (AxB)

20-0745 130 x 30 mm (AxB)

20-0746 120 x 25 mm (AxB)

20-0747 100 x 25 mm (AxB)

► **20-0748** 80 x 20 mm (AxB)



BRUNNER
20-0742
- **20-0748**
25 cm, 10"

1/2

Wundhaken für Eingriffe in der Tiefe

Retractors for Deep Surgery

Separadores para cirugía profunda

Ecarteurs pour interventions en profondeur

Divaricatori per interventi in profondità

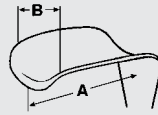

20-0797 180 x 30 mm (AxB)

20-0796 160 x 30 mm (AxB)

20-0795 140 x 25 mm (AxB)

20-0794 120 x 25 mm (AxB)

20-0793 100 x 20 mm (AxB)

► **20-0792** 80 x 20 mm (AxB)



BRUNNER
20-0792
- **20-0797**
25 cm, 10"



Wundhaken für Eingriffe in der Tiefe

Retractors for Deep Surgery

Separadores para cirugía profunda

Ecarteurs pour interventions en profondeur

Divaricatori per interventi in profondità

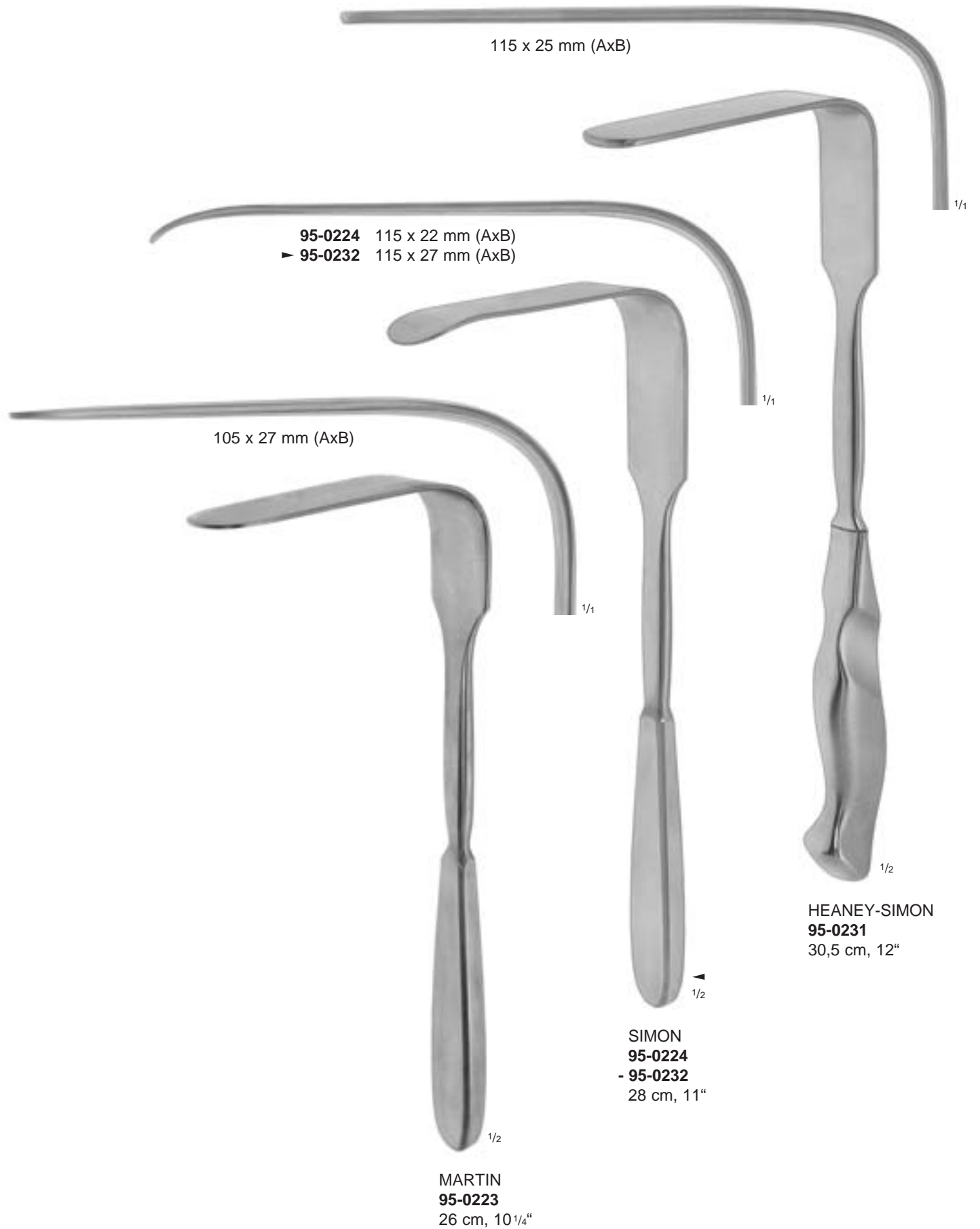
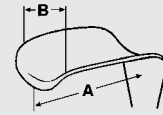

Wundhaken für Eingriffe in der Tiefe

Retractors for Deep Surgery

Separadores para cirugía profunda

Ecarteurs pour interventions en profondeur

Divaricatori per interventi in profondità

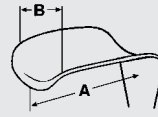

- ▶ **20-0940** 160 x 38 mm (AxB)
- 20-0941** 160 x 57 mm (AxB)

20-0933 155 x 50 mm (AxB)

▶ **20-0932** 125 x 50 mm (AxB)

20-0931 90 x 35 mm (AxB)

85 X 35 mm (AxB)

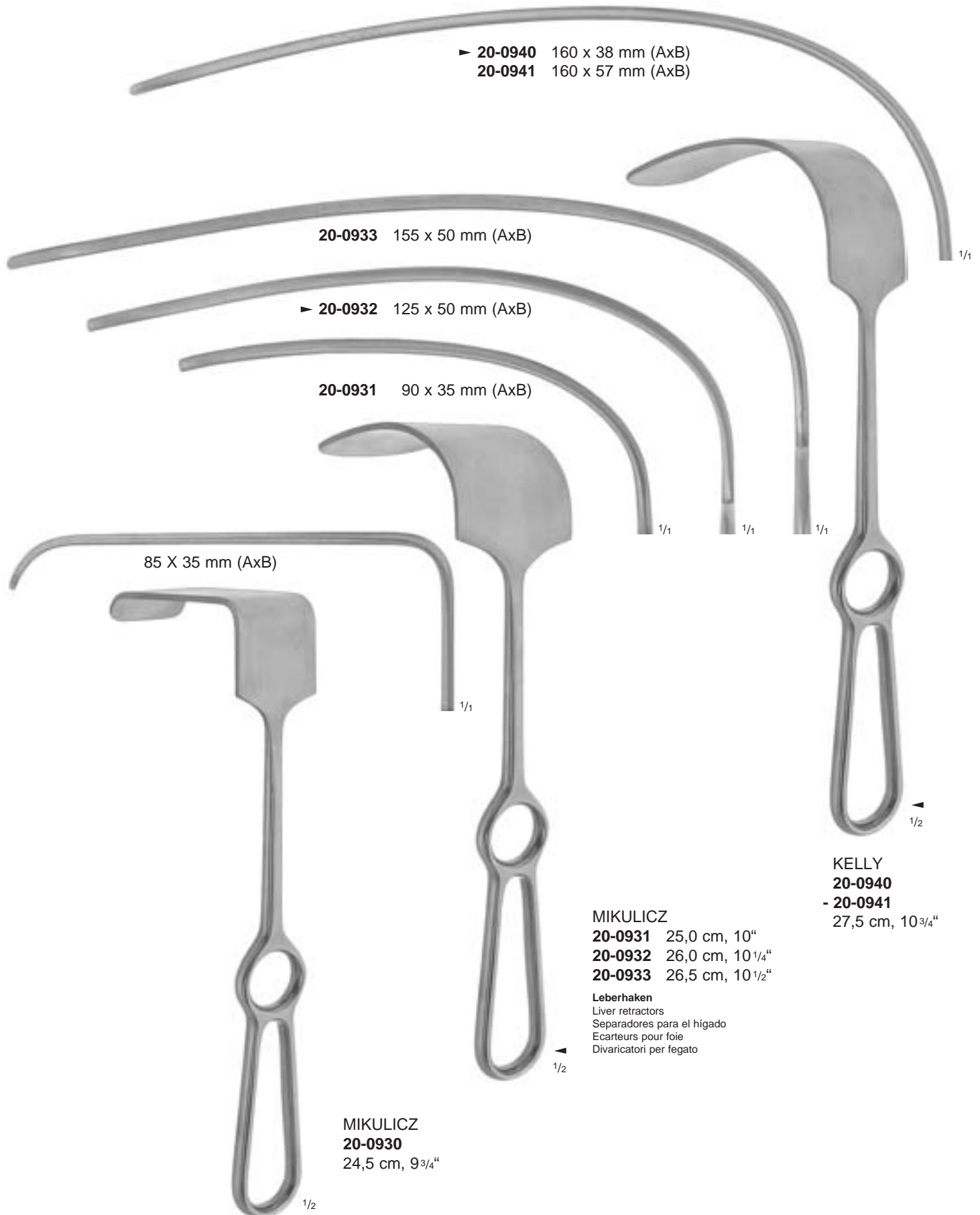

KELLY
20-0940
- **20-0941**
27,5 cm, 10³/₄"

MIKULICZ
20-0931 25,0 cm, 10"
20-0932 26,0 cm, 10¹/₄"
20-0933 26,5 cm, 10¹/₂"

Leberhaken
Liver retractors
Separadores para el hígado
Ecarteurs pour foie
Divaricatori per fegato

MIKULICZ
20-0930
24,5 cm, 9³/₄"



Wundhaken für Eingriffe in der Tiefe

Retractors for Deep Surgery

Separadores para cirugía profunda

Ecarteurs pour interventions en profondeur

Divaricatori per interventi in profondità

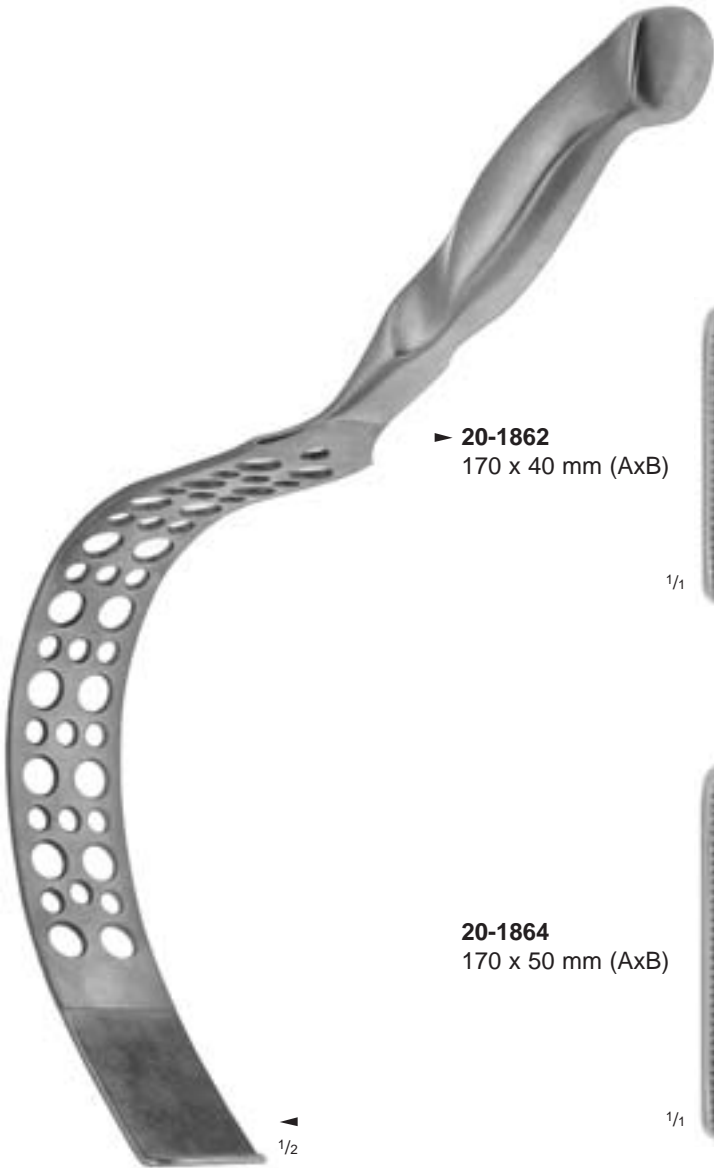
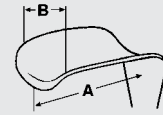

► **20-1862**
170 x 40 mm (AxB)

1/1

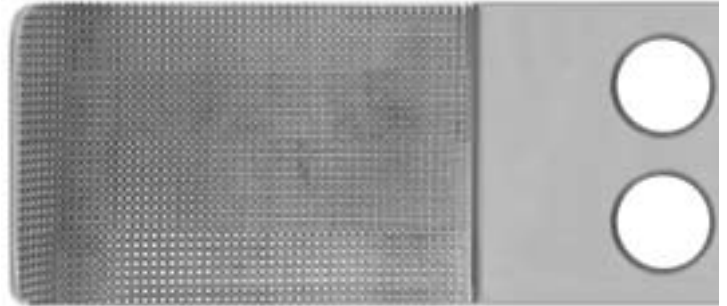

20-1864
170 x 50 mm (AxB)

1/1

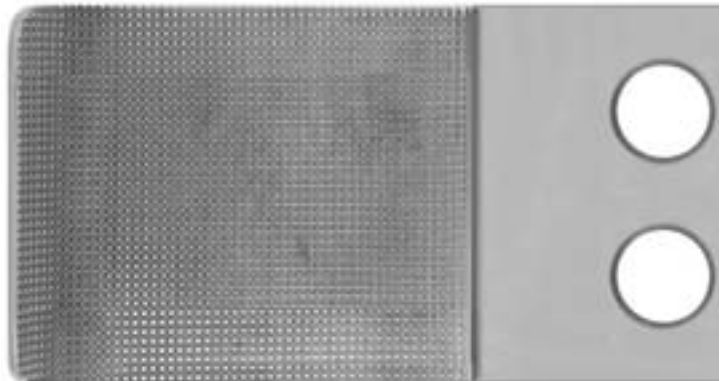

THORLAKSON

20-1862

- **20-1866**

33 cm, 13"

Pelvishaken

Pelvis retractors

Separadores para pelvis

Ecarteurs à pelvis

Divaricatori per pelvis

20-1866
170 x 65 mm (AxB)

1/1

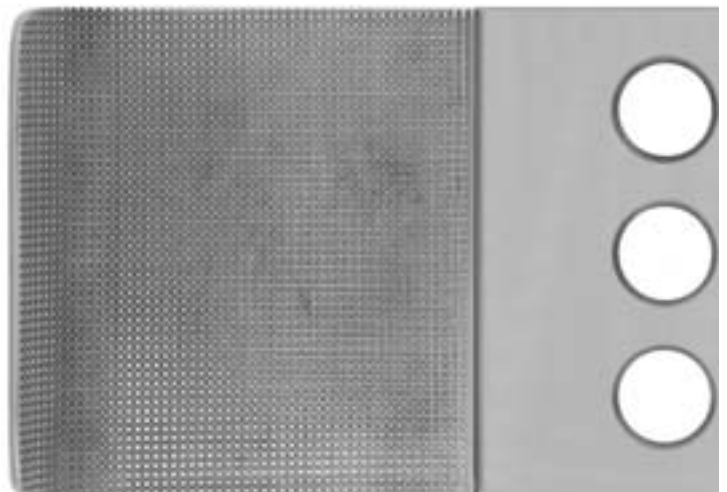

Wundhaken für Eingriffe in der Tiefe

Retractors for Deep Surgery

Separadores para cirugía profunda

Ecarteurs pour interventions en profondeur

Divaricatori per interventi in profondità

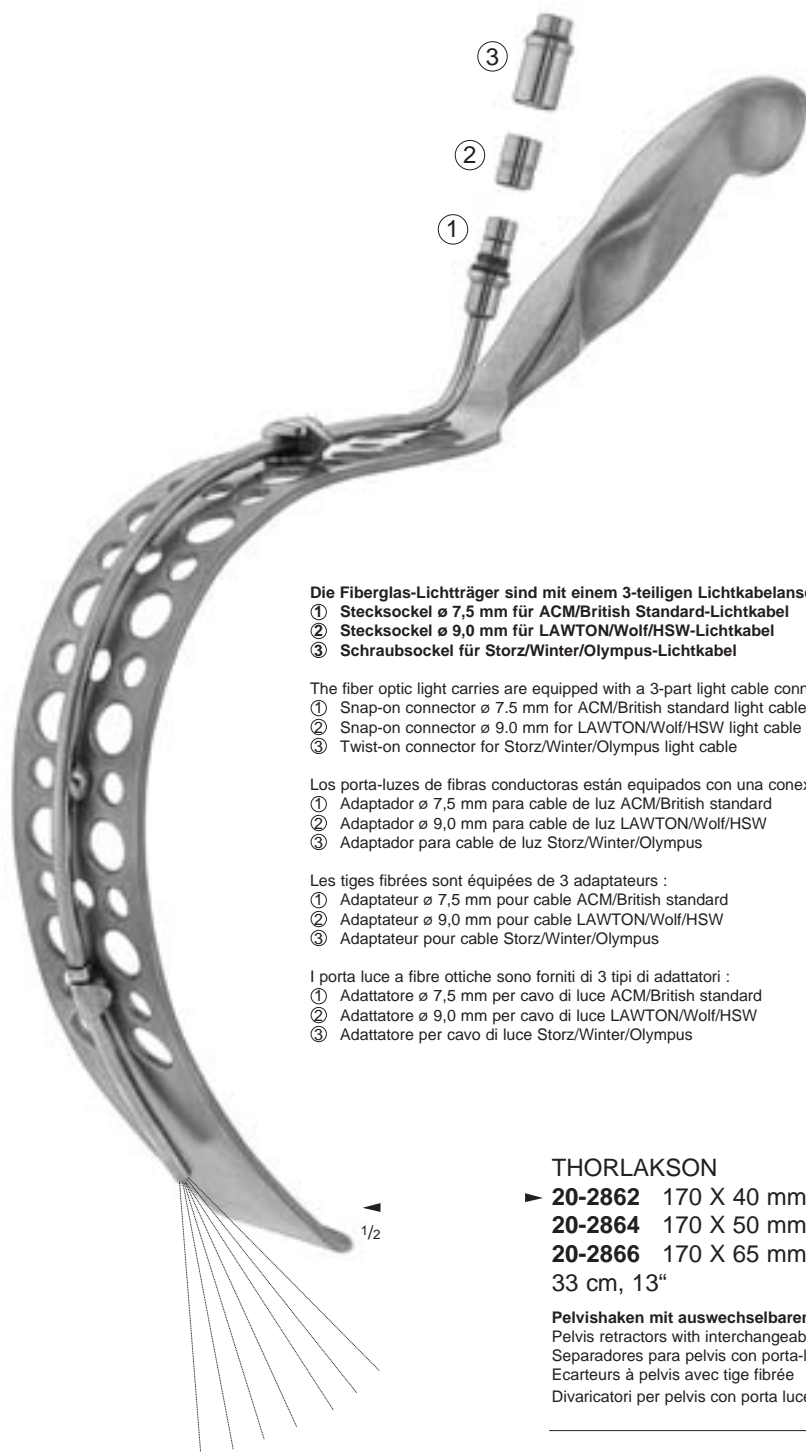
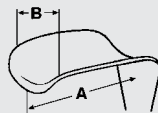

Die Fiberglas-Lichtträger sind mit einem 3-teiligen Lichtkabelanschluß ausgestattet :

- ① Stecksocket ø 7,5 mm für ACM/British Standard-Lichtkabel
- ② Stecksocket ø 9,0 mm für LAWTON/Wolf/HSW-Lichtkabel
- ③ Schraubsocket für Storz/Winter/Olympus-Lichtkabel

The fiber optic light carries are equipped with a 3-part light cable connector :

- ① Snap-on connector ø 7.5 mm for ACM/British standard light cable
- ② Snap-on connector ø 9.0 mm for LAWTON/Wolf/HSW light cable
- ③ Twist-on connector for Storz/Winter/Olympus light cable

Los porta-luz de fibras conductoras están equipados con una conexión de 3 adaptadores :

- ① Adaptador ø 7,5 mm para cable de luz ACM/British standard
- ② Adaptador ø 9,0 mm para cable de luz LAWTON/Wolf/HSW
- ③ Adaptador para cable de luz Storz/Winter/Olympus

Les tiges fibrées sont équipées de 3 adaptateurs :

- ① Adaptateur ø 7,5 mm pour cable ACM/British standard
- ② Adaptateur ø 9,0 mm pour cable LAWTON/Wolf/HSW
- ③ Adaptateur pour cable Storz/Winter/Olympus

I porta luce a fibre ottiche sono forniti di 3 tipi di adattatori :

- ① Adattatore ø 7,5 mm per cavo di luce ACM/British standard
- ② Adattatore ø 9,0 mm per cavo di luce LAWTON/Wolf/HSW
- ③ Adattatore per cavo di luce Storz/Winter/Olympus

THORLAKSON

- ▶ **20-2862** 170 X 40 mm (AxB)
 - 20-2864** 170 X 50 mm (AxB)
 - 20-2866** 170 X 65 mm (AxB)
- 33 cm, 13"

Pelvishaken mit auswechselbarem Fiberglas-Lichtträger

Pelvis retractors with interchangeable fiber optic light carrier
Separadores para pelvis con porta-luz de fibras conductoras intercambiables
Ecarteurs à pelvis avec tige fibrée
Divaricatori per pelvis con porta luce a fibre ottiche intercambiabile

20-2868

Fiberglas-Lichtträger allein (ohne Halterung)

Fiber optic light carrier only (without fixation devices)
Porta-luz de fibras conductoras, suelto (sin fijación)
Tige porte lampe fibrée (sans fixation)
Solo porta luce a fibre ottiche (senza dispositivo di fissaggio)

20-2869

Halterung allein

Fixation devices only
Fijación, suelta
Fixation seule
Solo dispositivo di fissaggio

• Optimale Ausleuchtung des Operationsfeldes

• Optimal illumination of surgical sites

• Iluminación óptima para el campo de operación

• Eclairage maximal du champ opératoire

• Ottima illuminazione del campo operatorio



Wundhaken für Eingriffe in der Tiefe

Retractors for Deep Surgery

Separadores para cirugía profunda

Ecarteurs pour interventions en profondeur

Divaricatori per interventi in profondità

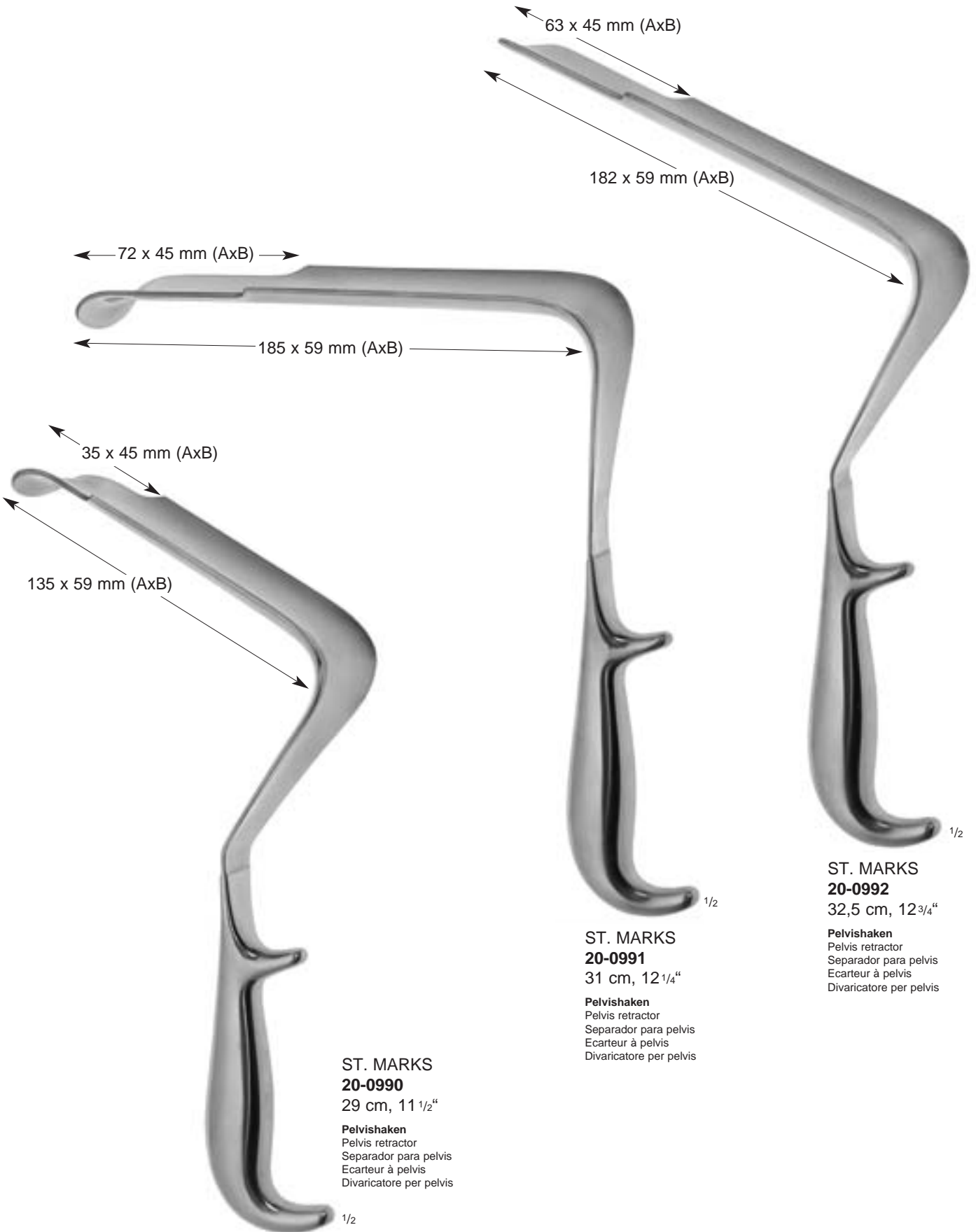
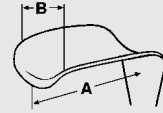

63 x 45 mm (AxB)

182 x 59 mm (AxB)

72 x 45 mm (AxB)

185 x 59 mm (AxB)

35 x 45 mm (AxB)

135 x 59 mm (AxB)

**ST. MARKS
20-0990**
29 cm, 11 1/2"

Pelvishaken
Pelvis retractor
Separador para pelvis
Ecarteur à pelvis
Divaricatore per pelvis

**ST. MARKS
20-0991**
31 cm, 12 1/4"

Pelvishaken
Pelvis retractor
Separador para pelvis
Ecarteur à pelvis
Divaricatore per pelvis

**ST. MARKS
20-0992**
32,5 cm, 12 3/4"

Pelvishaken
Pelvis retractor
Separador para pelvis
Ecarteur à pelvis
Divaricatore per pelvis

Wundhaken für Eingriffe in der Tiefe

Retractors for Deep Surgery

Separadores para cirugía profunda

Ecarteurs pour interventions en profondeur

Divaricatori per interventi in profondità

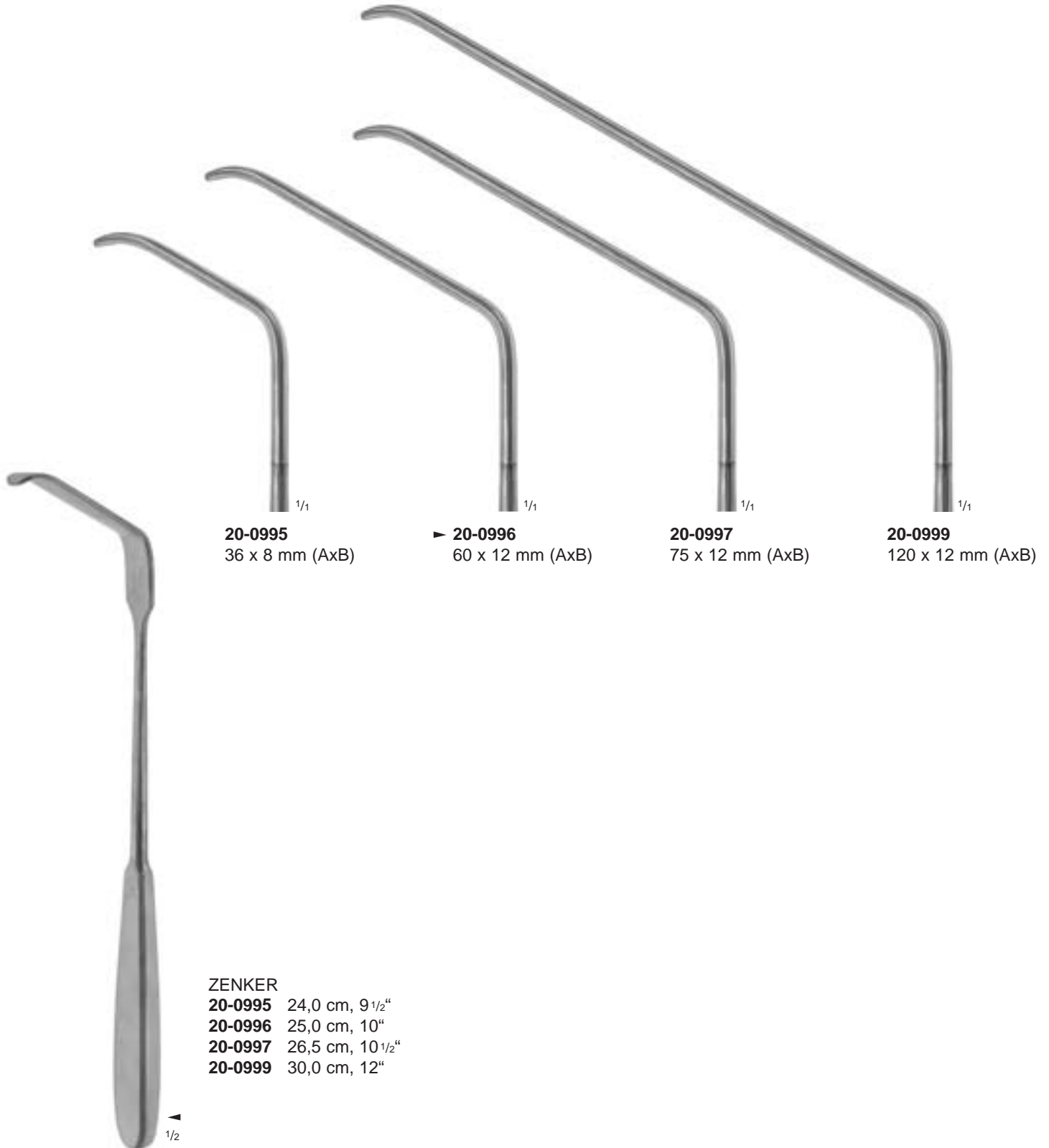
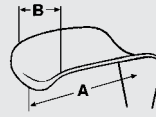

20-0995
36 x 8 mm (AxB)

▶ **20-0996**
60 x 12 mm (AxB)

20-0997
75 x 12 mm (AxB)

20-0999
120 x 12 mm (AxB)

ZENKER
20-0995 24,0 cm, 9 1/2"
20-0996 25,0 cm, 10"
20-0997 26,5 cm, 10 1/2"
20-0999 30,0 cm, 12"



Scapula-Haken

Scapula Retractors
Separadores para scápula
Ecarteur à scapula
Divaricatori per scapola

Lungenhaken

Lung Retractors
Separadores para el pulmón
Ecarteur à poumons
Divaricatori per polmone



DAVIDSON
37-0450

22 cm, 8 3/4"

Scapula-Haken
Scapula retractor
Separador para scápula
Ecarteur à scapula
Dicaricatore per scapola



▶ 37-0320
18 mm



37-0321
24 mm



SEMB
37-0320

- 37-0321
27,5 cm, 10 3/4"

Lungenhaken
Lung retractors
Separadores para el pulmón
Ecarteurs à poumons
Divaricatori per polmone



ALLISON
37-0370

32,5 cm, 12 3/4"

Lungenspatel
Lung spatula
Espátula para el pulmón
Spatule pulmonaire
Spatole per polmone



DAVIDSON
37-0455

22 cm, 8 3/4"

Scapula-Haken
Scapula retractor
Separador para scápula
Ecarteur à scapula
Dicaricatore per scapola

Wundhaken und Lungenspatel

Retractors and Lung Spatulas

Separadores y espátulas para el pulmón

Ecarteurs et spatules pulmonaires

Divaricatori e spatole per polmone

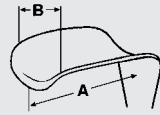

115 x 64 mm (AxB)

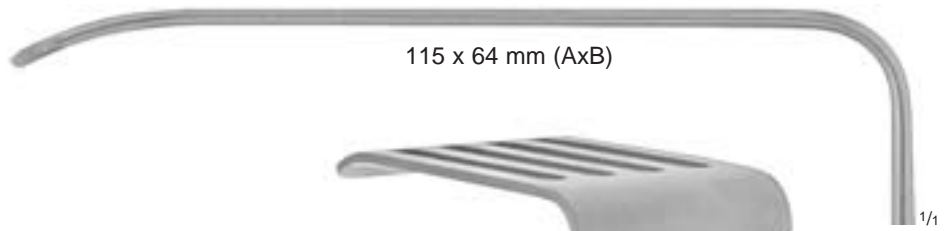

108 x 43 mm (AxB)

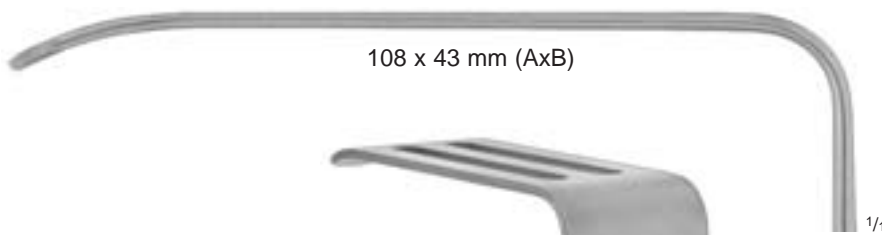

82 x 21 mm (AxB)

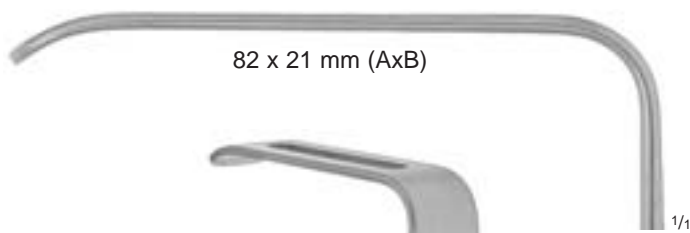

CORYLLOS
37-0447
24,5 cm, 9³/₄"



CORYLLOS
37-0446
24,5 cm, 9³/₄"



CORYLLOS
37-0445
24,5 cm, 9³/₄"





Wundhaken und Lungenspatel

Retractors and Lung Spatulas

Separadores y espátulas para el pulmón

Ecarteurs et spatules pulmonaires

Divaricatori e spatole per polmone

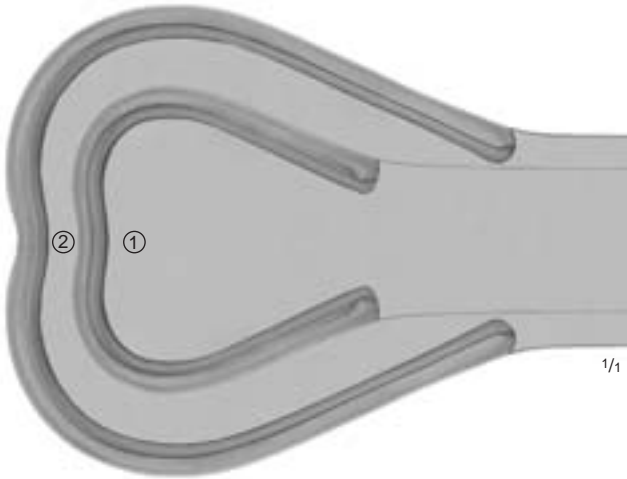
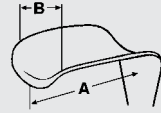

1/1

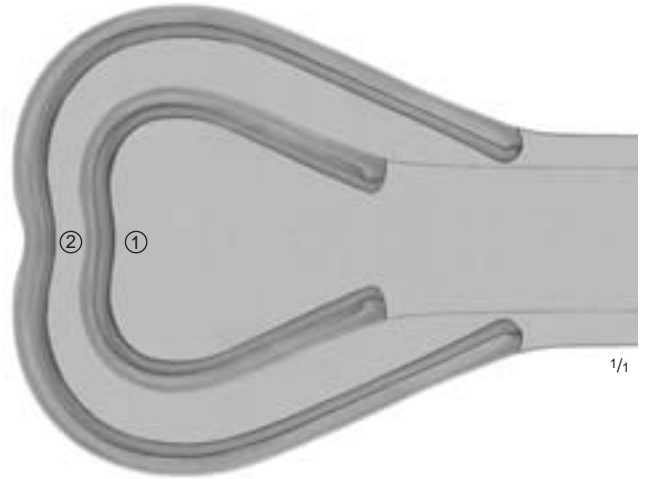

1/1

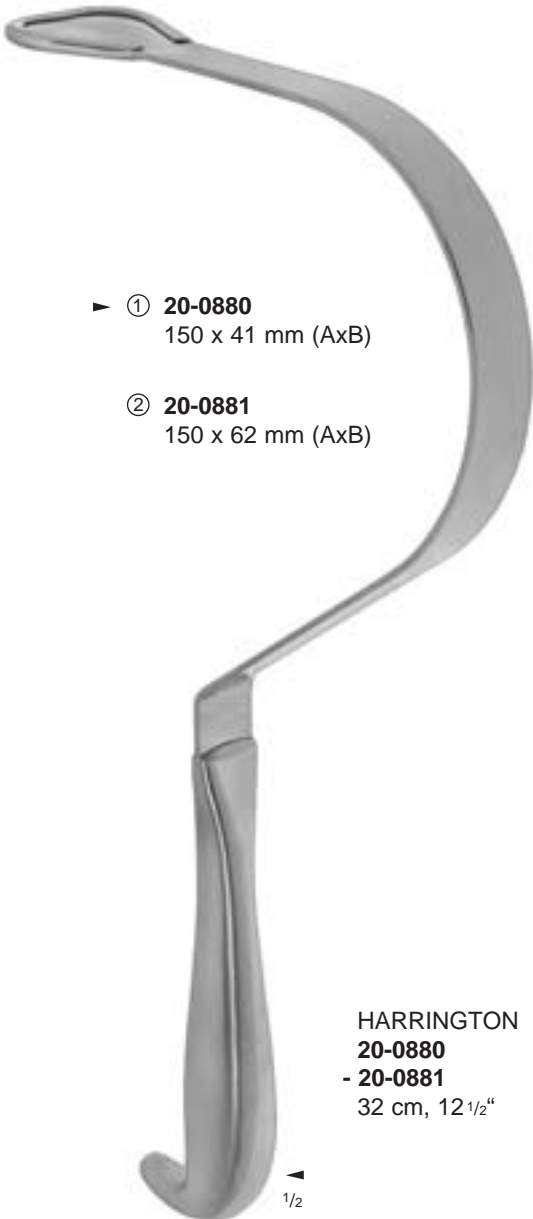

- ▶ ① **20-0880**
150 x 41 mm (AxB)
- ② **20-0881**
150 x 62 mm (AxB)

HARRINGTON
20-0880
- **20-0881**
32 cm, 12 1/2"

1/2

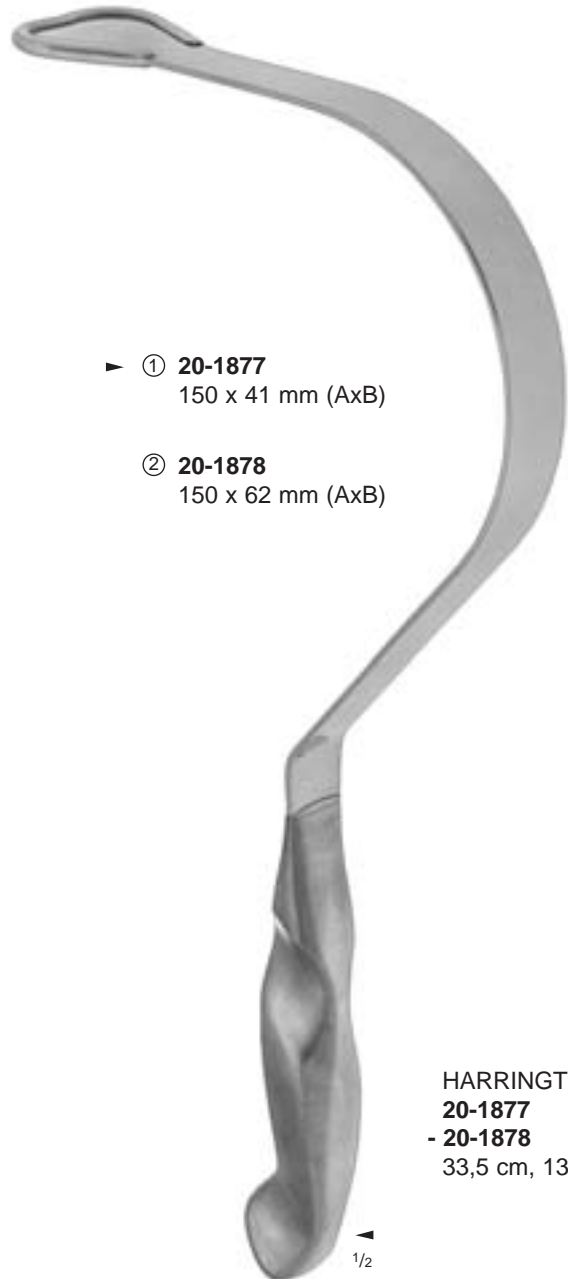

- ▶ ① **20-1877**
150 x 41 mm (AxB)
- ② **20-1878**
150 x 62 mm (AxB)

HARRINGTON
20-1877
- **20-1878**
33,5 cm, 13 1/4"

1/2

Wundhaken und Lungenspatel

Retractors and Lung Spatulas

Separadores y espátulas para el pulmón

Ecarteurs et spatules pulmonaires

Divaricatori e spatole per polmone

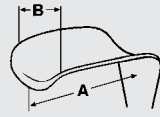

1/1



165 x 50 mm (AxB)

FOSS
20-1872
36,5 cm, 14"

1/2



160 x 50 mm (AxB)

FORD-
DEAVER
20-1792
42 cm, 16 1/2"

1/2



Wundhaken und Lungenspatel

Retractors and Lung Spatulas

Separadores y espátulas para el pulmón

Ecarteurs et spatules pulmonaires

Divaricatori e spatole per polmone

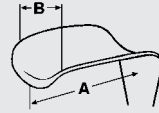

111 x 25 mm (AxB)

DEAVER
20-0803
23 cm, 9"

1/3



40 x 19 mm (AxB)

DEAVER
20-0804
18 cm, 7"

1/3



55 x 22 mm (AxB)

DEAVER
20-0805
22 cm, 8³/₄"

1/3



55 x 25 mm (AxB)

DEAVER
20-0810
23 cm, 9"

1/3



100 x 25 mm (AxB)

DEAVER
20-0806
30 cm, 12"

1/3



100 x 25 mm (AxB)

DEAVER
20-0807
33 cm, 13"

1/3



100 x 25 mm (AxB)

DEAVER
20-0808
36 cm, 14"

1/3

Wundhaken und Lungenspatel

Retractors and Lung Spatulas

Separadores y espátulas para el pulmón

Ecarteurs et spatules pulmonaires

Divaricatori e spatole per polmone

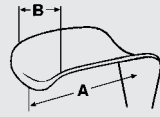

100 x 38 mm (AxB)



DEAVER
20-0809
30 cm, 12"

100 x 50 mm (AxB)



DEAVER
20-0811
30 cm, 12"

100 x 75 mm (AxB)



DEAVER
20-0812
30,5 cm, 12"

100 x 25 mm (AxB)



DEAVER
20-1816
30 cm, 12"

100 x 38 mm (AxB)



DEAVER
20-1831
30 cm, 12"

100 x 50 mm (AxB)



DEAVER
20-1836
30 cm, 12"

100 x 75 mm (AxB)



DEAVER
20-1841
30 cm, 12"



Bauch- und Darmspatel

Abdominal and Intestinal Spatulas
Espátulas abdominales e intestinales
Spatules abdominaux et intestinaux
Spatole addominali e intestinali



20-0847
170 x 16 mm

biegsam
malleable
maleable
malléable
malleabile



20-0848
190 x 25 mm

biegsam
malleable
maleable
malléable
malleabile



▶ **20-0852** 200 x 13 mm
20-0853 200 x 16 mm

biegsam
malleable
maleable
malléable
malleabile



20-0849 330 x 20 mm
20-0850 330 x 25 mm
20-0855 330 x 30 mm
▶ **20-0860** 330 x 35 mm
20-0861 330 x 40 mm
20-0862 330 x 45 mm
20-0865 330 x 50 mm

biegsam
malleable
maleable
malléable
malleabile

Bauch- und Darmspatel

Abdominal and Intestinal Spatulas
Espátulas abdominales e intestinales
Spatules abdominaux et intestinaux
Spatole addominali e intestinali

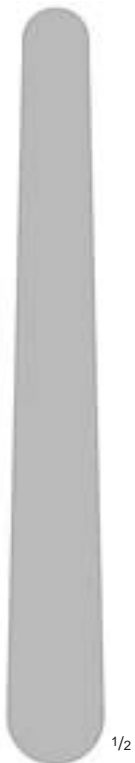

TUFFIER
20-0874
200 x 17/24 mm

biegsam
malleable
maleable
malléable
malleabile



HABERER
20-0873
300 x 40/50 mm

biegsam
malleable
maleable
malléable
malleabile



REVERDIN
20-0871
280 x 41/65 mm

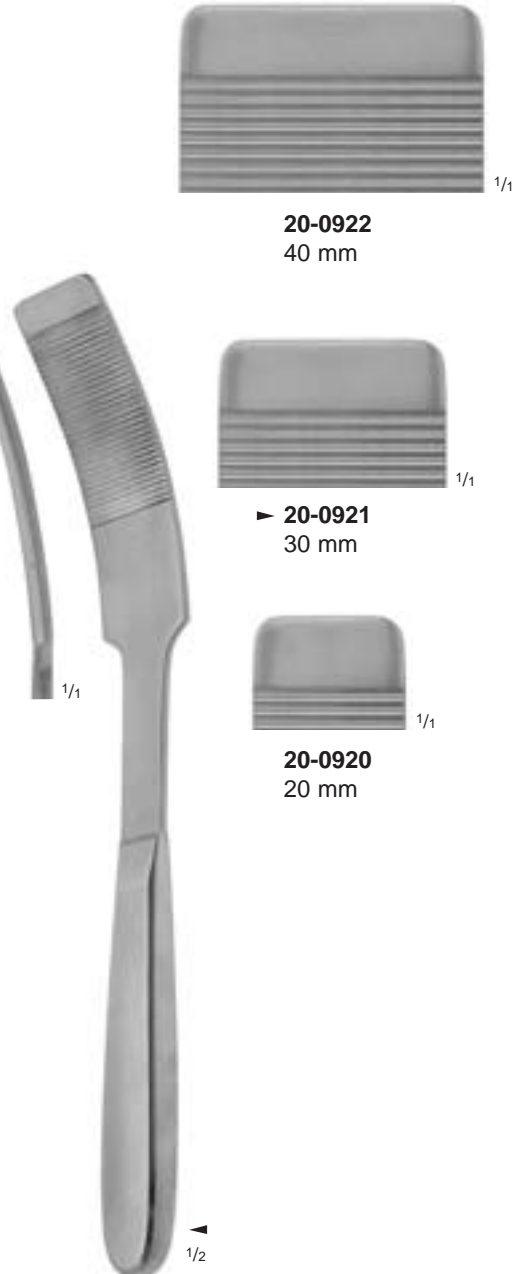

KADER
20-0920
- **20-0922**
26,5 cm, 10 1/2"



Blasenspatel

Bladder Spatulas
Espátulas para la vesícula
Spatules vésicales
Spatole vescicali

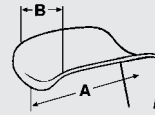

105 x 35 mm (AxB)



LEGUEU
92-0145
27 cm, 10³/₄"

105 x 67 mm (AxB)



KOCHER
92-0150
25 cm, 10"



LAWNTON

Medizintechnik



Wundspreizer (selbsthaltend), Bauchdeckenhalter
Self-Retaining Retractors, Abdominal Retractors
Separadores con retenida automática, Separadores abdominales
Ecarteurs autostatiques, Ecarteurs abdominaux
Divaricatori autostatici, Divaricatori addominali



Wundspreizer, selbsthaltend
 Self-Retaining Retractors
 Separadores con retenida automática
 Ecarteurs autostatiques
 Divaricatori autostatici



► 21-0147
5 cm, 2"

spitz • sharp • agudo • pointu • acuto



21-0157
5 cm, 2"

stumpf • blunt • romo • mousse • smusso

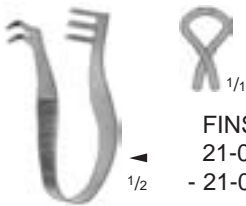

FINSEN
21-0147
- 21-0157



► 21-0148
7 cm, 2 3/4"

spitz • sharp • agudo • pointu • acuto

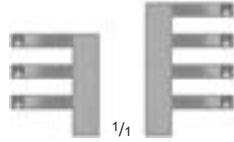

21-0158
7 cm, 2 3/4"

stumpf • blunt • romo • mousse • smusso

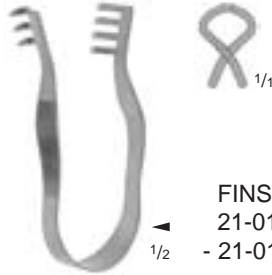

FINSEN
21-0148
- 21-0158

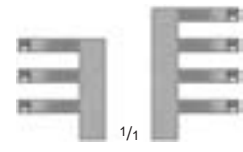

► 21-0149
7 cm, 2 3/4"

spitz • sharp • agudo • pointu • acuto



21-0159
7 cm, 2 3/4"

stumpf • blunt • romo • mousse • smusso

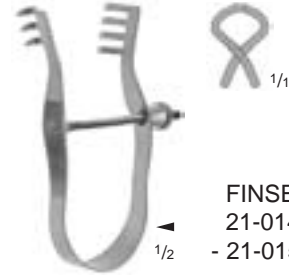

FINSEN
21-0149
- 21-0159

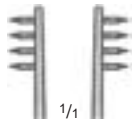

► 21-0150
7 cm, 2 3/4"

spitz • sharp • agudo • pointu • acuto

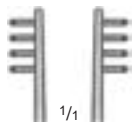

21-0151
7 cm, 2 3/4"

stumpf • blunt • romo • mousse • smusso



ALM
21-0150
- 21-0151

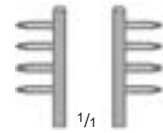

► 21-0152
10 cm, 4"

spitz • sharp • agudo • pointu • acuto

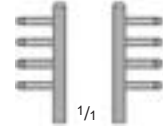

21-0153
10 cm, 4"

stumpf • blunt • romo • mousse • smusso



ALM
21-0152
- 21-0153

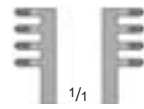

► 21-0155
10 cm, 4"

spitz • sharp • agudo • pointu • acuto



21-0156
10 cm, 4"

stumpf • blunt • romo • mousse • smusso



21-0155
- 21-0156

Wundspreizer, selbsthaltend
 Self-Retaining Retractors
 Separadores con retenida automática
 Ecarteurs autostatiques
 Divaricatori autostatici

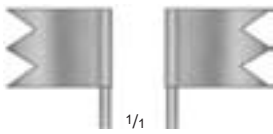

spitz • sharp • agudo • pointu • acuto

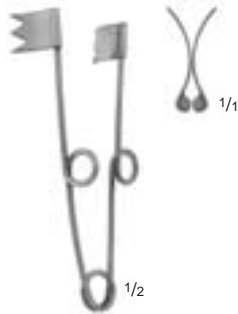

21-0128
 8 cm, 3 1/8"

Wundspreizer, selbsthaltend
 Self-retaining retractor
 Separador con retenida automática
 Ecarteur autostatiques
 Divaricatore autostatici



VICKERS
 21-0170
 4,5 cm, 1 3/4"

Finger-Wundspreizer
 Finger retractor
 Separador para dedos
 Ecarteur pour doigts
 Divaricatore per dita

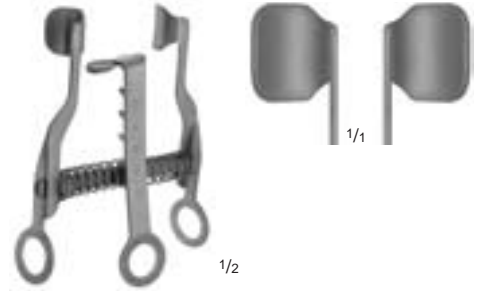

VICKERS
 21-0172
 8 cm, 3 1/8"

Schnellender Finger- und kleiner Schnitt-Wund-
 spreizer, mit Mittelvalve 18 x 10 mm (21-0179)

Trigger finger and small wound retractor, with
 central valve 18 x 10 mm (21-0179)

Separador para dedos y pequeñas heridas, con
 valva central 18 x 10 mm (21-0179)

Ecarteur pour doigts et petites plaies, avec valve
 médiane 18 x 10 mm (21-0179)

Impugnatura a molla per dita e piccolo divaricatore
 per ferite, con valva centrale 18 x 10 mm (21-0179)



stumpf • blunt • romo • mousse • smusso



VICKERS
 21-0174
 9 cm, 3 1/2"

Hand- und Carpal-Tunnel-Wundspreizer, mit Mittelvalve 18 x 10 mm (21-0179)
 Hand and carpal tunnel retractor, with central valve 18 x 10 mm (21-0179)
 Separador de mano y túnel de carpo, con valva central 18 x 10 mm (21-0179)
 Ecarteur pour mains et tunnel carpien, avec valve médiane 18 x 10 mm (21-0179)
 Divaricatore per la mano con condotto carpale, con valva centrale 18 x 10 mm (21-0179)

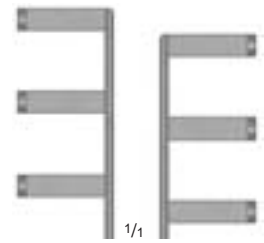

stumpf • blunt • romo • mousse • smusso



VICKERS
 21-0176
 10 cm, 4"

Hand- und Unterarm-Wundspreizer, mit Mittelvalve 18 x 10 mm (21-0179)
 Deep hand and forearm retractor, with central valve 18 x 10 mm (21-0179)
 Separador profundo para mano y antebrazo, con valva central 18 x 10 mm (21-0179)
 Ecarteur profond pour main et avant bras, avec valve médiane 18 x 10 mm (21-0179)
 Divaricatore per la mano e l'avambraccio, con valva centrale 18 x 10 mm (21-0179)



Wundspreizer, selbsthaltend
 Self-Retaining Retractors
 Separadores con retenida automática
 Ecarteurs autostatiques
 Divaricatori autostatici

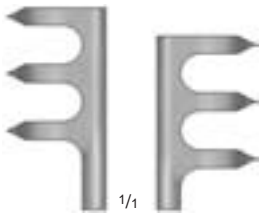

spitz • sharp • agudo • pointu • acuto

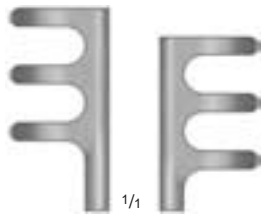

stumpf • blunt • romo • mousse • smusso

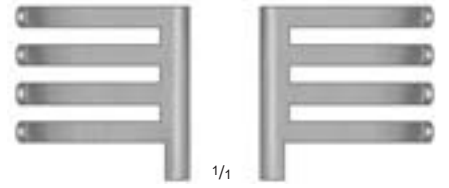

stumpf • blunt • romo • mousse • smusso



JANSEN
 66-0700
 10 cm, 4"



JANSEN
 66-0701
 10 cm, 4"

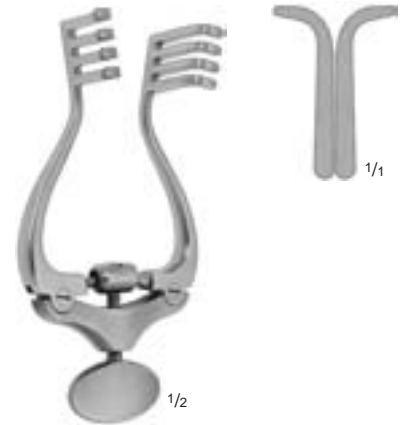

JANSEN
 52-0350
 11 cm, 4 3/8"



► 21-0195
 10,5 cm, 4 1/8"
 spitz • sharp • agudo
 pointu • acuto



21-0196
 10,5 cm, 4 1/8"
 stumpf • blunt • romo
 mousse • smusso



► 21-0200
 13,5 cm, 5 1/4"
 spitz • sharp • agudo
 pointu • acuto

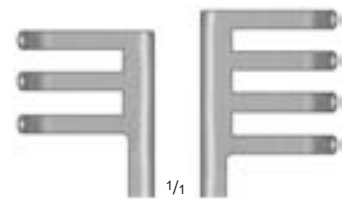

21-0220
 13,5 cm, 5 1/4"
 stumpf • blunt • romo
 mousse • smusso

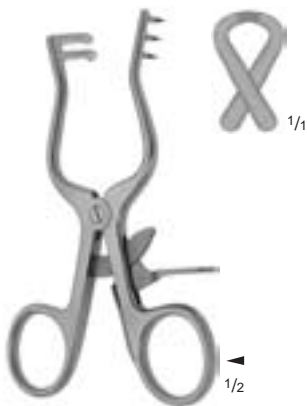

WEITLANER
 21-0195
 - 21-0196



WEITLANER
 21-0200
 - 21-0220



▶ 21-0205
 16,5 cm, 6 1/2"

spitz • sharp • agudo • pointu • acuto



▶ 21-0210
 19,5 cm, 7 3/4"

spitz • sharp • agudo • pointu • acuto

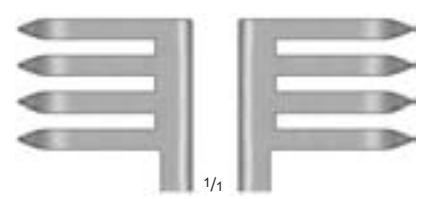

▶ 21-0260
 19,5 cm, 7 3/4"

spitz • sharp • agudo • pointu • acuto



21-0225
 16,5 cm, 6 1/2"

stumpf • blunt • romo • mousse • smusso

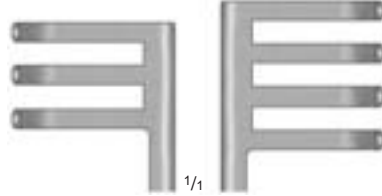

21-0230
 19,5 cm, 7 3/4"

stumpf • blunt • romo • mousse • smusso

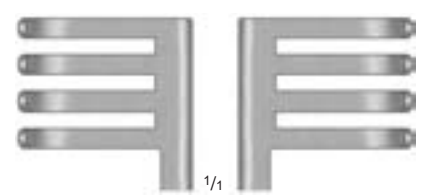

21-0263
 19,5 cm, 7 3/4"

stumpf • blunt • romo • mousse • smusso



WEITLANER
 21-0205
 - 21-0225



WEITLANER
 21-0210
 - 21-0230

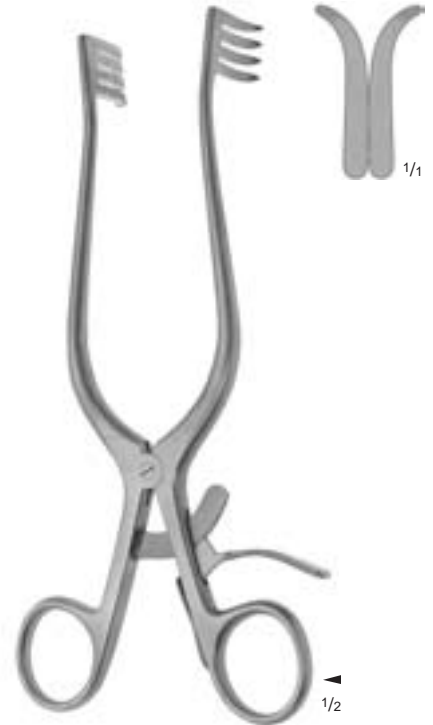

ADSON
 21-0260
 - 21-0263



Wundspreizer, selbsthaltend
 Self-Retaining Retractors
 Separadores con retenida automática
 Ecarteurs autostatiques
 Divaricatori autostatici



▶ 21-0215
 25 cm, 10"

spitz • sharp • agudo • pointu • acuto

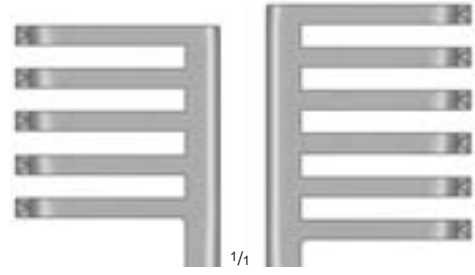

▶ 21-0216
 25,5 cm, 10"

spitz • sharp • agudo • pointu • acuto



21-0235
 25 cm, 10"

stumpf • blunt • romo • mousse • smusso

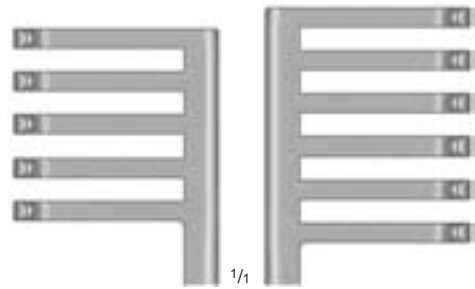

21-0217
 25,5 cm, 10"

stumpf • blunt • romo • mousse • smusso



WEITLANER
 21-0215
 - 21-0235



WEITLANER
 21-0216
 - 21-0217

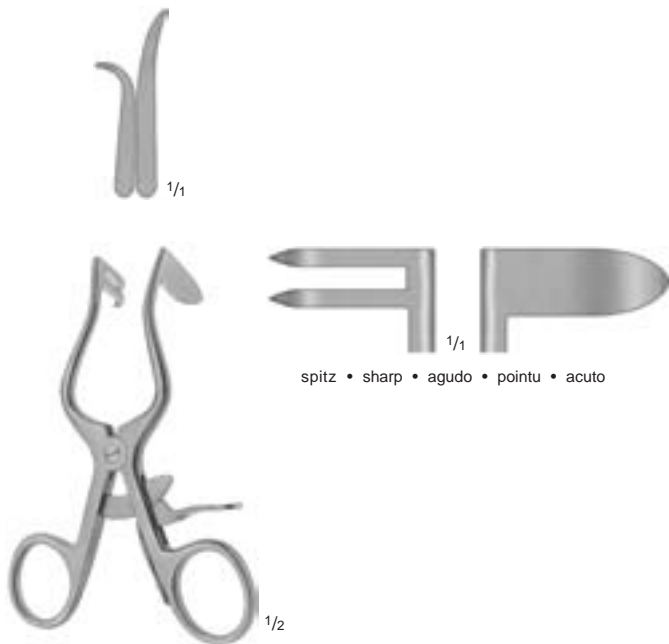

PLESTER
 21-0282
 10,5 cm, 4 1/8"

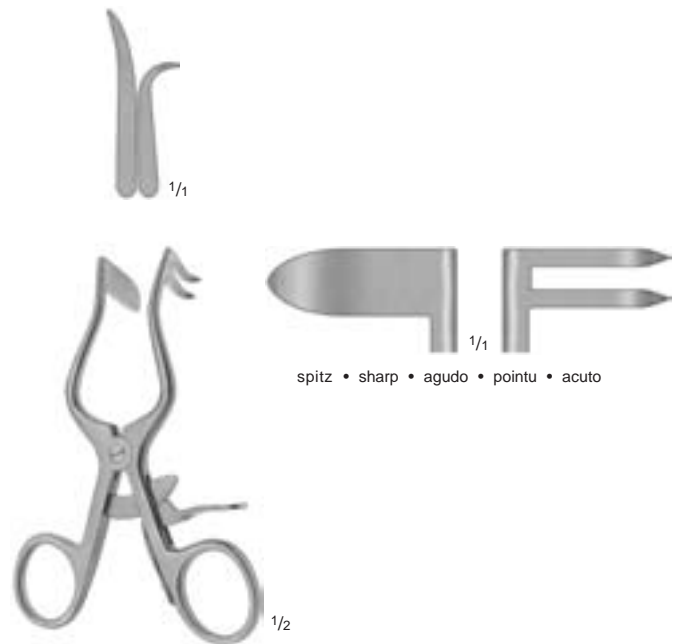

PLESTER
 21-0283
 10,5 cm, 4 1/8"

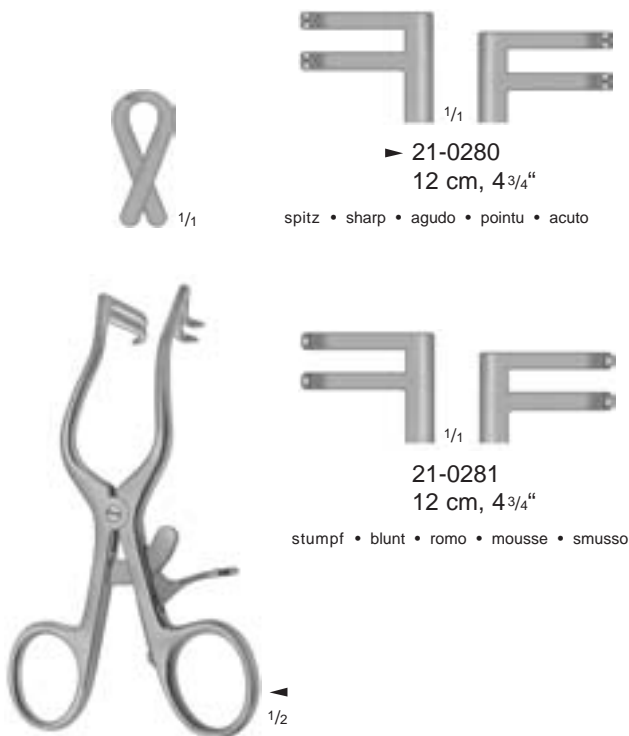

PLESTER
 21-0280
 - 21-0281

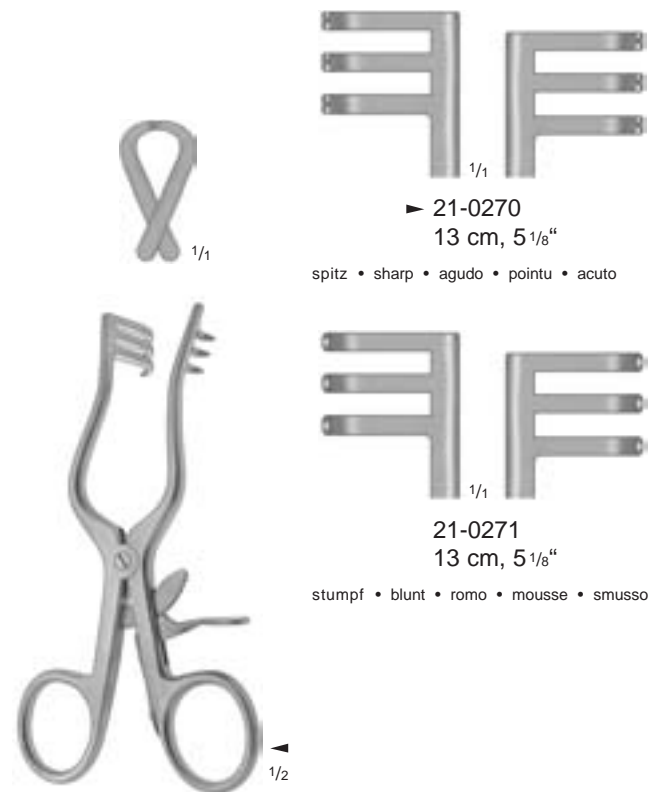

WULLSTEIN
 21-0270
 - 21-0271

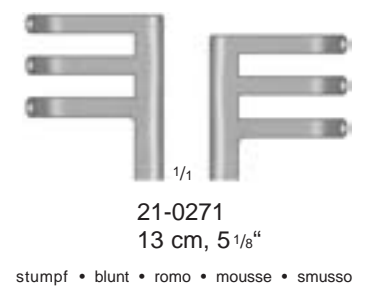



Wundspreizer, selbsthaltend
 Self-Retaining Retractors
 Separadores con retenida automática
 Ecarteurs autostatiques
 Divaricatori autostatici

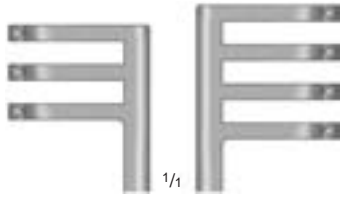

► 52-0394
 13,5 cm, 5 1/4"

spitz • sharp • agudo • pointu • acuto



52-0395
 13,5 cm, 5 1/4"

stumpf • blunt • romo • mousse • smusso



SCALP CONTOUR
 52-0394
 - 52-0395

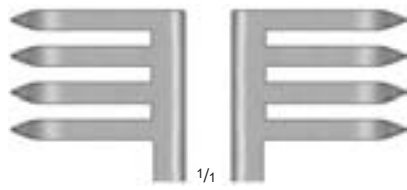

spitz • sharp • agudo • pointu • acuto



ANDERSON-ADSON
 21-0266
 19 cm, 7 1/2"



spitz • sharp • agudo • pointu • acuto



ADSON
 21-0261
 28 cm, 11"

Laminektomie-Wundspreizer
 Laminectomy retractor
 Separador para laminectomia
 Ecarteurs pour laminectomie
 Divaricatori per laminectomia

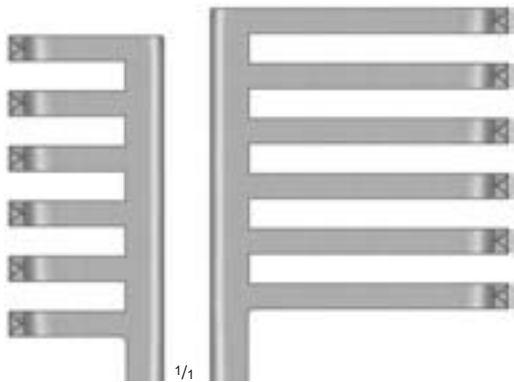

spitz • sharp • agudo • pointu • acuto

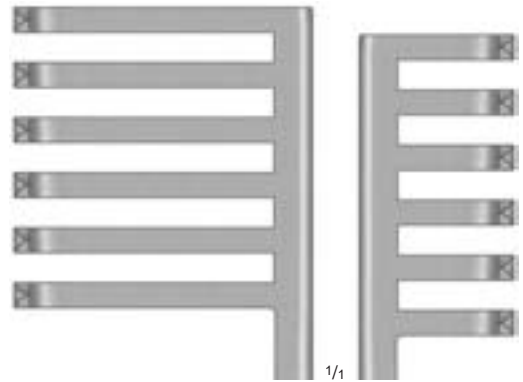

spitz • sharp • agudo • pointu • acuto



ADSON
 21-0267
 28,5 cm, 11 1/4"



ADSON
 21-0268
 28,5 cm, 11 1/4"



Wundspreizer, selbsthaltend
 Self-Retaining Retractors
 Separadores con retenida automática
 Ecarteurs autostatiques
 Divaricatori autostatici



▶ 21-0240
 14 cm, 5 1/2"

spitz • sharp • agudo • pointu • acuto

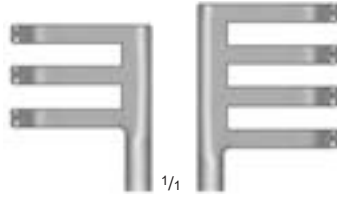

▶ 21-0242
 16 cm, 6 1/4"

spitz • sharp • agudo • pointu • acuto



▶ 21-0245
 21 cm, 8 1/4"

spitz • sharp • agudo • pointu • acuto



21-0241
 14 cm, 5 1/2"

stumpf • blunt • romo • mousse • smusso

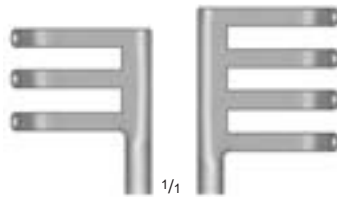

21-0243
 16 cm, 6 1/4"

stumpf • blunt • romo • mousse • smusso

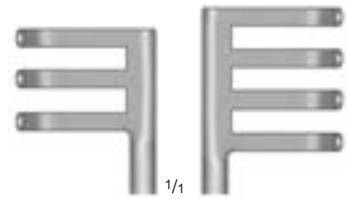

21-0246
 21 cm, 8 1/4"

stumpf • blunt • romo • mousse • smusso

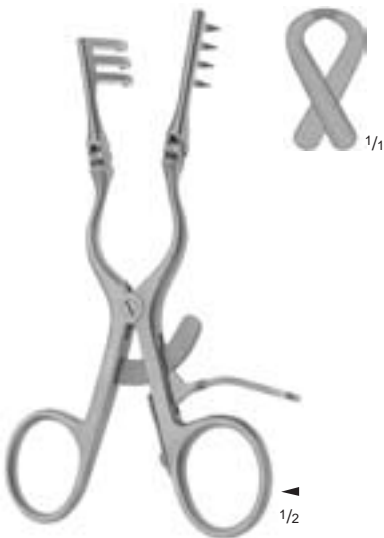

ADSON
 21-0240
 - 21-0241



ADSON
 21-0242
 - 21-0243



ADSON
 21-0245
 - 21-0246

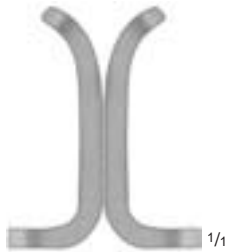

1/1

► 52-0491
 30,5 cm, 12"

spitz • sharp • agudo • pointu • acuto

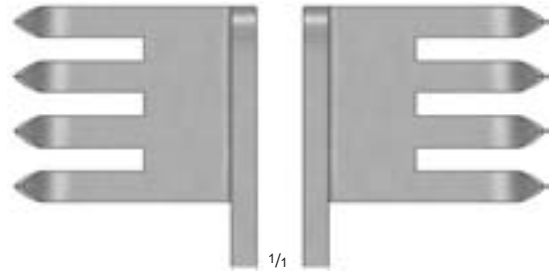

1/1

52-0490
 30,5 cm, 12"

stumpf • blunt • romo • mousse • smusso

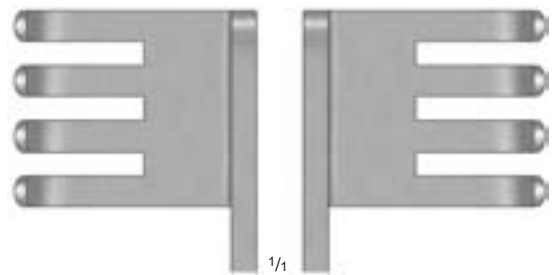

1/1

52-0494
 30,5 cm, 12"

spitz • sharp • agudo • pointu • acuto

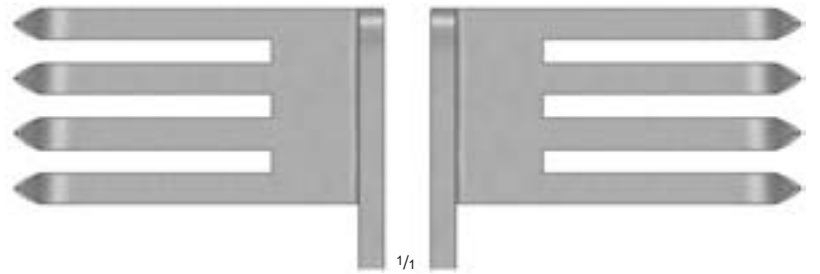

1/1

52-0497
 30,5 cm, 12"

stumpf • blunt • romo • mousse • smusso



1/2

BECKMANN-ADSON
 52-0490
 - 52-0497



Laminektomie-Wundspreizer
 Laminectomy Retractors
 Separadores para laminectomía
 Ecarteurs pour laminectomie
 Divaricatori per laminectomia

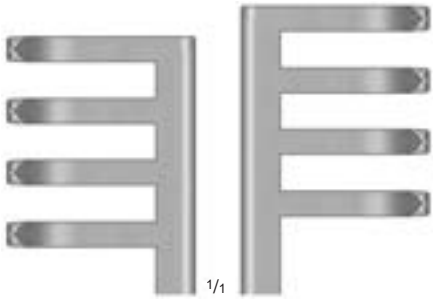

spitz • sharp • agudo • pointu • acuto

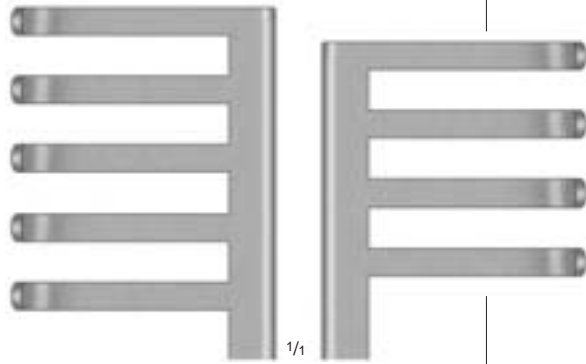

stumpf • blunt • romo • mousse • smusso

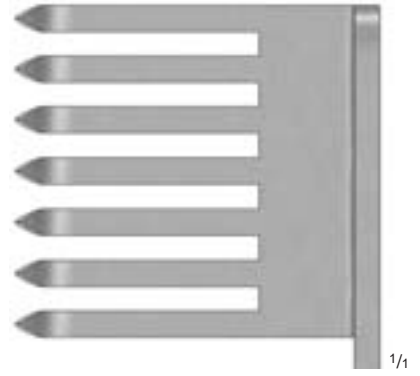

spitz • sharp • agudo • pointu • acuto



BECKMANN
 12-0410
 31,5 cm, 12 1/2"



ADSON
 52-0499
 33 cm, 13"



BECKMANN-EATON
 21-0252
 32 cm, 12 1/2"

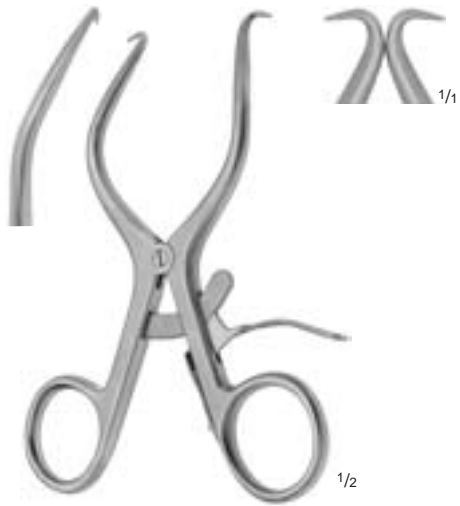

GELPI-BABY
 21-0306
 13 cm, 5 1/8"

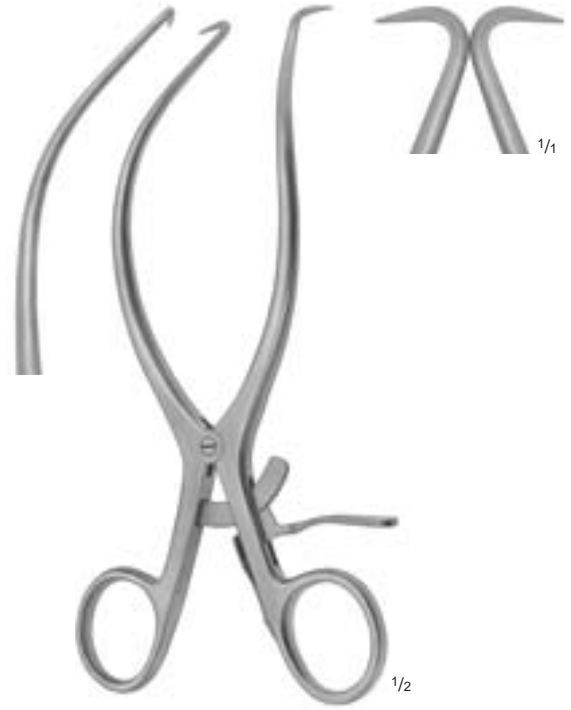

GELPI
 21-0300
 18,5 cm, 7 1/4"

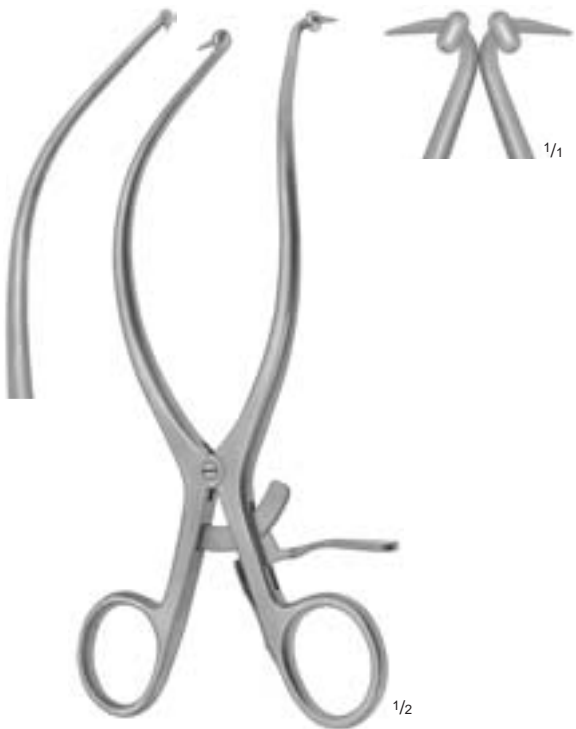

GELPI
 21-0305
 19 cm, 7 1/2"



GELPI-SELETZ
 21-0301
 16 cm, 6 1/4"



Wundspreizer, selbsthaltend
Self-Retaining Retractors
Separadores con retenida automática
Ecarteurs autostatiques
Divaricatori autostatici

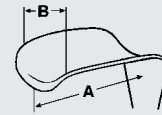

spitz • sharp • agudo • pointu • acuto

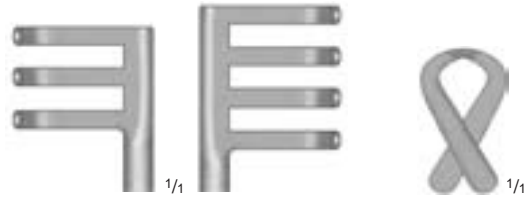

stumpf • blunt • romo • mousse • smusso

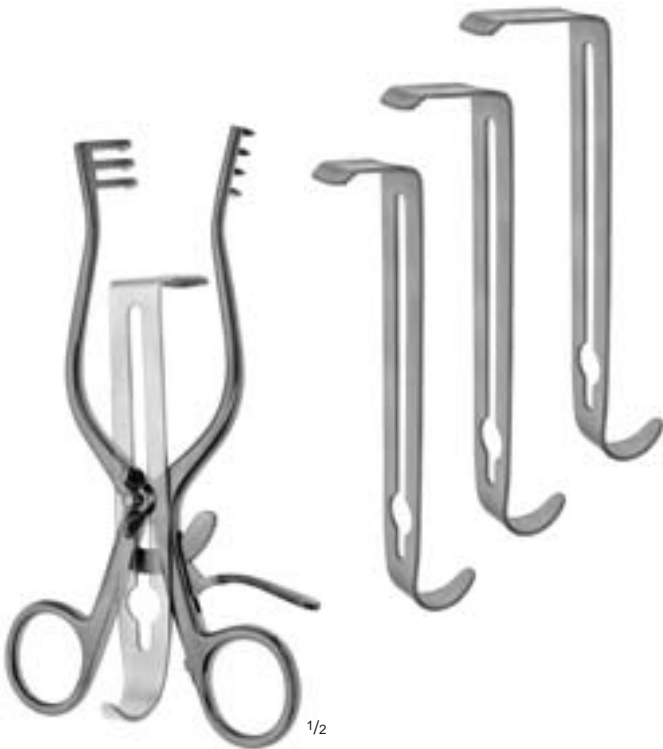

HENLEY

21-0325

16,5 cm, 6 1/2"

Wundspreizer, komplett, bestehend aus:

- 21-0326 1 Sperrer mit Seitenvalven, spitz
- 21-0327 1 gezahnten Mittelvalve 19 x 16 mm (AxB)
- 21-0328 1 gezahnten Mittelvalve 26 x 16 mm (AxB)
- 21-0329 1 gezahnten Mittelvalve 32 x 16 mm (AxB)

Self-retaining retractor, complete, consisting of:

- 21-0326 1 Spreader with lateral valves, sharp
- 21-0327 1 Central valve, serrated, 19 x 16 mm (AxB)
- 21-0328 1 Central valve, serrated, 26 x 16 mm (AxB)
- 21-0329 1 Central valve, serrated, 32 x 16 mm (AxB)

Separador, completo, compuesto de:

- 21-0326 1 Separador con valvas laterales agudas
- 21-0327 1 Valva central, dentada, 19 x 16 mm (AxB)
- 21-0328 1 Valva central, dentada, 26 x 16 mm (AxB)
- 21-0329 1 Valva central, dentada, 32 x 16 mm (AxB)

Ecarteur, complet, composé de:

- 21-0326 1 Ecarteur avec valvas latérales, griffes pointues
- 21-0327 1 Valve centrale, dentelée, 19 x 16 mm (AxB)
- 21-0328 1 Valve centrale, dentelée, 26 x 16 mm (AxB)
- 21-0329 1 Valve centrale, dentelée, 32 x 16 mm (AxB)

Divaricatore, completo, composto da:

- 21-0326 1 Divaricatore con valve laterali, acuto
- 21-0327 1 Valva centrale, dentellata, 19 x 16 mm (AxB)
- 21-0328 1 Valva centrale, dentellata, 26 x 16 mm (AxB)
- 21-0329 1 Valva centrale, dentellata, 32 x 16 mm (AxB)



HENLEY

21-0335

16,5 cm, 6 1/2"

Wundspreizer, komplett, bestehend aus:

- 21-0336 1 Sperrer mit Seitenvalven, stumpf
- 21-0327 1 gezahnten Mittelvalve 19 x 16 mm (AxB)
- 21-0328 1 gezahnten Mittelvalve 26 x 16 mm (AxB)
- 21-0329 1 gezahnten Mittelvalve 32 x 16 mm (AxB)

Self-retaining retractor, complete, consisting of:

- 21-0336 1 Spreader with lateral valves, blunt
- 21-0327 1 Central valve, serrated, 19 x 16 mm (AxB)
- 21-0328 1 Central valve, serrated, 26 x 16 mm (AxB)
- 21-0329 1 Central valve, serrated, 32 x 16 mm (AxB)

Separador, completo, compuesto de:

- 21-0336 1 Separador con valvas laterales romas
- 21-0327 1 Valva central, dentada, 19 x 16 mm (AxB)
- 21-0328 1 Valva central, dentada, 26 x 16 mm (AxB)
- 21-0329 1 Valva central, dentada, 32 x 16 mm (AxB)

Ecarteur, complet, composé de:

- 21-0336 1 Ecarteur avec valvas latérales, griffes mous
- 21-0327 1 Valve centrale, dentelée, 19 x 16 mm (AxB)
- 21-0328 1 Valve centrale, dentelée, 26 x 16 mm (AxB)
- 21-0329 1 Valve centrale, dentelée, 32 x 16 mm (AxB)

Divaricatore, completo, composto da:

- 21-0336 1 Divaricatore con valve laterali, smusso
- 21-0327 1 Valva centrale, dentellata, 19 x 16 mm (AxB)
- 21-0328 1 Valva centrale, dentellata, 26 x 16 mm (AxB)
- 21-0329 1 Valva centrale, dentellata, 32 x 16 mm (AxB)

Wundspreizer, selbsthaltend
 Self-Retaining Retractors
 Separadores con retenida automática
 Ecarteurs autostatiques
 Divaricatori autostatici

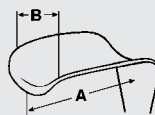

In Peripheral-Chirurgie zu verwenden!
 To be used for peripheral vascular surgery!
 Uso para cirugía periférica!
 Utilise pour la chirurgie vasculaire périphérique!
 Da impiegarsi in interventi vascolari periferici!



21-0327
 19 x 16 mm (Ax B)

21-0328
 26 x 16 mm (Ax B)

21-0329
 32 x 16 mm (Ax B)

21-0374
 76 x 16 mm (Ax B)



HENLEY
 21-0365
 18 cm, 7"

Wundspreizer, komplett, bestehend aus:
 21-0366 1 Sperrer
 21-0327 1 gezahnten Mittelvalve
 19 x 16 mm (Ax B)
 21-0328 1 gezahnten Mittelvalve
 26 x 16 mm (Ax B)
 21-0329 1 gezahnten Mittelvalve
 32 x 16 mm (Ax B)
 21-0374 1 gezahnten Mittelvalve
 76 x 16 mm (Ax B)
 21-0367 1 Paar stumpfen Seitenvalven
 25 x 23 mm (Ax B)
 21-0368 1 Paar stumpfen Seitenvalven
 50 x 23 mm (Ax B)
 21-0369 1 Paar stumpfen Seitenvalven
 75 x 23 mm (Ax B)



21-0367
 25 x 23 mm (Ax B)



21-0368
 50 x 23 mm (Ax B)



21-0369
 75 x 23 mm (Ax B)

Self-retaining retractor, complete, consisting of:

- 21-0366 1 Spreader
- 21-0327 1 Central valve, serrated,
19 x 16 mm (Ax B)
- 21-0328 1 Central valve, serrated,
26 x 16 mm (Ax B)
- 21-0329 1 Central valve, serrated,
32 x 16 mm (Ax B)
- 21-0374 1 Central valve, serrated,
76 x 16 mm (Ax B)
- 21-0367 1 Pair lateral valves,
blunt, 25 x 23 mm (Ax B)
- 21-0368 1 Pair lateral valves,
blunt, 50 x 23 mm (Ax B)
- 21-0369 1 Pair lateral valves,
blunt, 75 x 23 mm (Ax B)

Ecarteur, complet, composé de:

- 21-0366 1 Ecarteur
- 21-0327 1 Valve centrale, dentelée,
19 x 16 mm (Ax B)
- 21-0328 1 Valve centrale, dentelée,
26 x 16 mm (Ax B)
- 21-0329 1 Valve centrale, dentelée,
32 x 16 mm (Ax B)
- 21-0374 1 Valve centrale, dentelée,
76 x 16 mm (Ax B)
- 21-0367 1 Paire de valves latérales,
mousses, 25 x 23 mm (Ax B)
- 21-0368 1 Paire de valves latérales,
mousses, 50 x 23 mm (Ax B)
- 21-0369 1 Paire de valves latérales,
mousses, 75 x 23 mm (Ax B)

Separador, completo, compuesto de:

- 21-0366 1 Separador
- 21-0327 1 Valva central, dentada,
19 x 16 mm (Ax B)
- 21-0328 1 Valva central, dentada,
26 x 16 mm (Ax B)
- 21-0329 1 Valva central, dentada,
32 x 16 mm (Ax B)
- 21-0374 1 Valva central, dentada,
76 x 16 mm (Ax B)
- 21-0367 1 Par de valvas laterales, romas,
25 x 23 mm (Ax B)
- 21-0368 1 Par de valvas laterales, romas,
50 x 23 mm (Ax B)
- 21-0369 1 Par de valvas laterales, romas,
75 x 23 mm (Ax B)

Divaricatore, completo, composto da:

- 21-0366 1 Divaricatore
- 21-0327 1 Valva centrale, dentellata,
19 x 16 mm (Ax B)
- 21-0328 1 Valva centrale, dentellata,
26 x 16 mm (Ax B)
- 21-0329 1 Valva centrale, dentellata,
32 x 16 mm (Ax B)
- 21-0374 1 Valva centrale, dentellata,
76 x 16 mm (Ax B)
- 21-0367 1 Paio di valve laterali, smusse,
25 x 23 mm (Ax B)
- 21-0368 1 Paio di valve laterali, smusse,
50 x 23 mm (Ax B)
- 21-0369 1 Paio di valve laterali, smusse,
75 x 23 mm (Ax B)



Appendektomie-Wundspreizer
 Appendectomy Retractors
 Separadores para apendectomía
 Ecarteurs pour appendicectomie
 Divaricatori per appendicectomia

Laminektomie-Wundspreizer
 Laminectomy Retractors
 Separadores para laminectomía
 Ecarteurs pour laminectomie
 Divaricatori per laminectomia



MAYO-ADAMS
 21-0320
 17 cm, 6³/₄"

Appendektomie-Wundspreizer, ohne Mittelvalve
 Appendectomy Retractor, without central valve
 Separador para apendectomía, sin valva central
 Ecarteur pour appendicectomie, sans valve médiane
 Divaricatore per appendicectomia, senza valva centrale

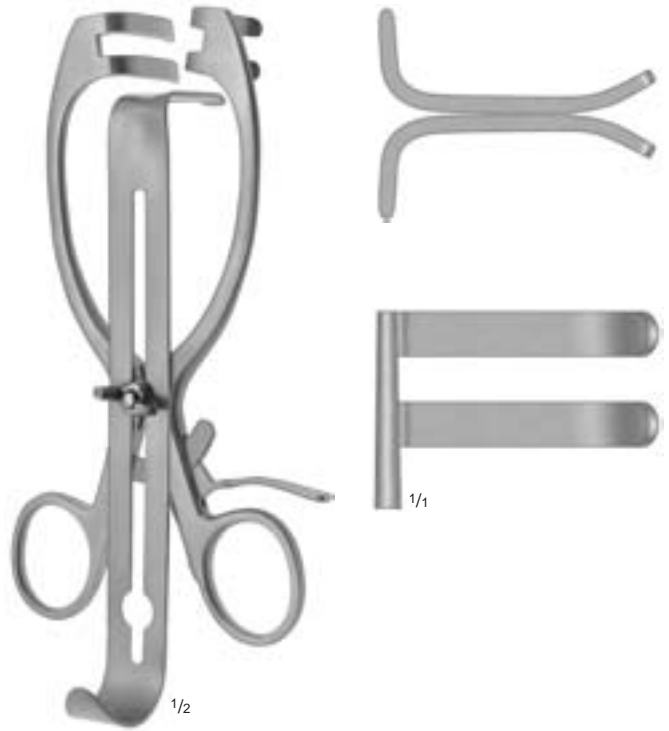

MAYO-ADAMS
 21-0310
 17 cm, 6³/₄"

Appendektomie-Wundspreizer, mit Mittelvalve 42 x 14 mm (21-0311)
 Appendectomy Retractor, with central valve 42 x 14 mm (21-0311)
 Separador para apendectomía, con valva central 42 x 14 mm (21-0311)
 Ecarteur pour appendicectomie, avec valve médiane 42 x 14 mm (21-0311)
 Divaricatore per appendicectomia, con valva centrale 42 x 14 mm (21-0311)

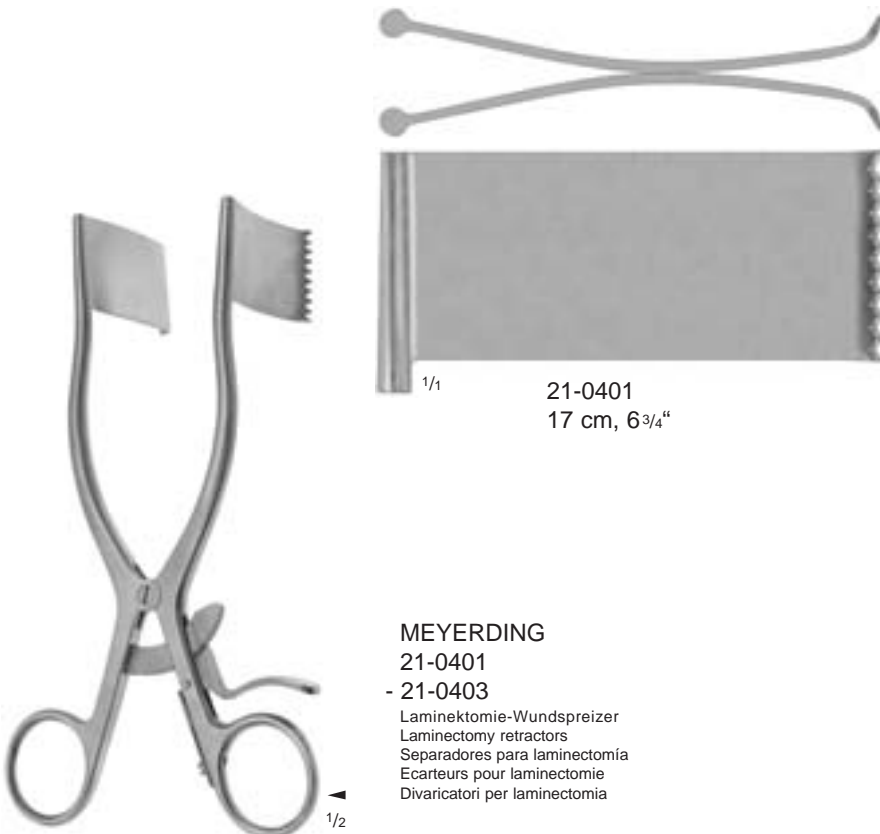

MEYERDING
 21-0401
 - 21-0403
 Laminektomie-Wundspreizer
 Laminectomy retractors
 Separadores para laminectomía
 Ecarteurs pour laminectomie
 Divaricatori per laminectomia

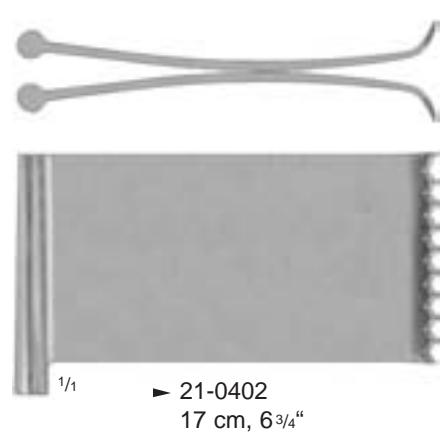

▶ 21-0402
 17 cm, 6³/₄"

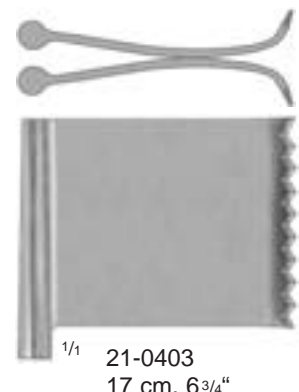

21-0403
 17 cm, 6³/₄"

Wundspreizer für die cervicale Wirbelsäule
 Retractors for cervical spine
 Separadores para la columna cervical
 Ecarteurs pour colonne cervicale
 Divaricatori per colonna cervicale

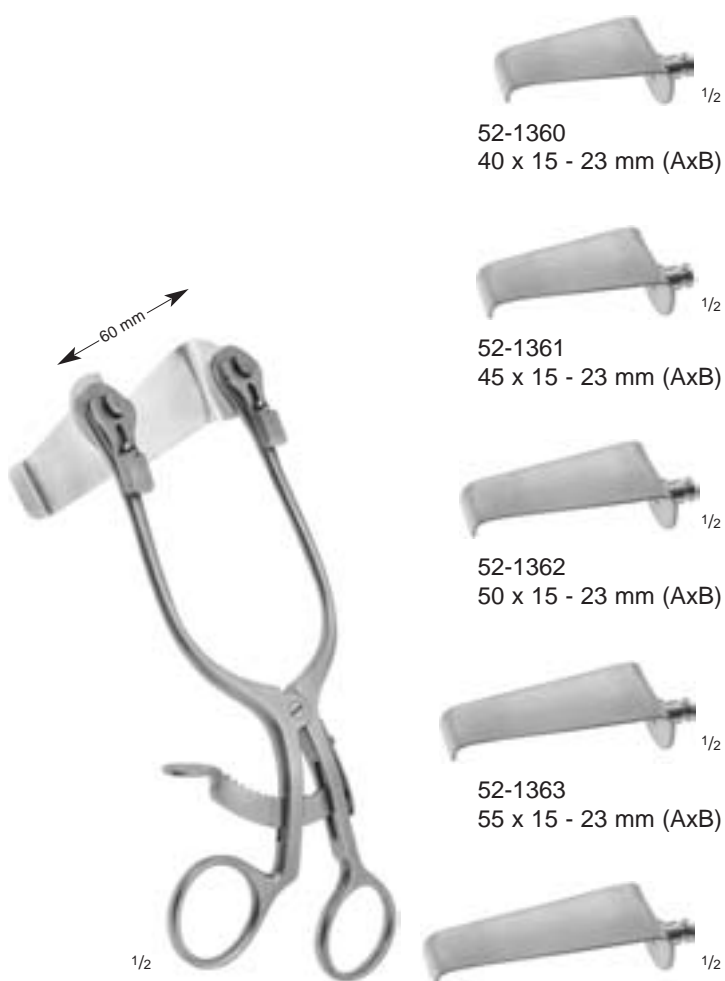
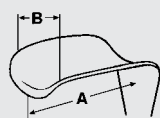

CLOWARD
 52-1355
 17 cm, 6^{3/4}"

52-1364
 60 x 15 - 23 mm (AxB)

Wundspreizer, komplett, bestehend aus:
 52-1356 1 Sperrer
 52-1360 1 stumpfen Seitenvalve 40 x 15 - 23 mm
 52-1361 1 stumpfen Seitenvalve 45 x 15 - 23 mm
 52-1362 1 stumpfen Seitenvalve 50 x 15 - 23 mm
 52-1363 1 stumpfen Seitenvalve 55 x 15 - 23 mm
 52-1364 1 stumpfen Seitenvalve 60 x 15 - 23 mm

Self-retaining retractor, complete, consisting of:
 52-1356 1 Spreader
 52-1360 1 Lateral valve, blunt, 40 x 15 - 23 mm
 52-1361 1 Lateral valve, blunt, 45 x 15 - 23 mm
 52-1362 1 Lateral valve, blunt, 50 x 15 - 23 mm
 52-1363 1 Lateral valve, blunt, 55 x 15 - 23 mm
 52-1364 1 Lateral valve, blunt, 60 x 15 - 23 mm

Separador, completo, compuesto de:
 52-1356 1 Separador
 52-1360 1 Valva lateral, roma, 40 x 15 - 23 mm
 52-1361 1 Valva lateral, roma, 45 x 15 - 23 mm
 52-1362 1 Valva lateral, roma, 50 x 15 - 23 mm
 52-1363 1 Valva lateral, roma, 55 x 15 - 23 mm
 52-1364 1 Valva lateral, roma, 60 x 15 - 23 mm

Ecarteur, complet, composé de:
 52-1356 1 Ecarteur
 52-1360 1 Valve latérale, mousse, 40 x 15 - 23 mm
 52-1361 1 Valve latérale, mousse, 45 x 15 - 23 mm
 52-1362 1 Valve latérale, mousse, 50 x 15 - 23 mm
 52-1363 1 Valve latérale, mousse, 55 x 15 - 23 mm
 52-1364 1 Valve latérale, mousse, 60 x 15 - 23 mm

Divaricatore, completo, composto da:
 52-1356 1 Divaricatore
 52-1360 1 Valva laterale, smussa, 40 x 15 - 23 mm
 52-1361 1 Valva laterale, smussa, 45 x 15 - 23 mm
 52-1362 1 Valva laterale, smussa, 50 x 15 - 23 mm
 52-1363 1 Valva laterale, smussa, 55 x 15 - 23 mm
 52-1364 1 Valva laterale, smussa, 60 x 15 - 23 mm

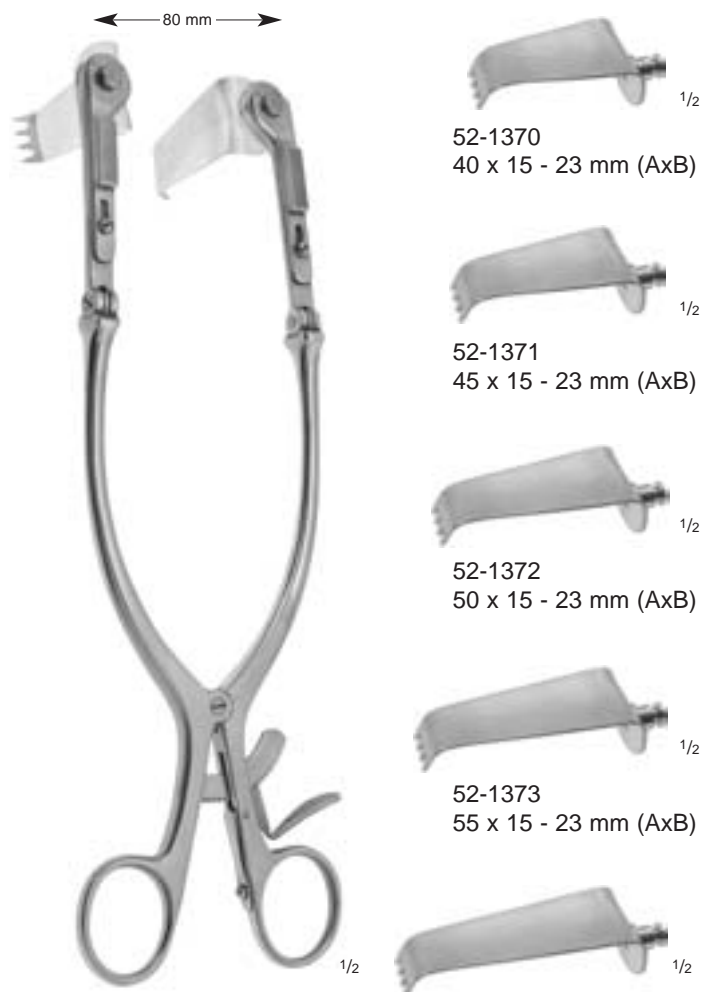

CLOWARD
 52-1345
 25 cm, 10"

52-1374
 60 x 15 - 23 mm (AxB)

Wundspreizer, komplett, bestehend aus:
 52-1346 1 Sperrer
 52-1370 1 gezahnten Seitenvalve 40 x 15 - 23 mm
 52-1371 1 gezahnten Seitenvalve 45 x 15 - 23 mm
 52-1372 1 gezahnten Seitenvalve 50 x 15 - 23 mm
 52-1373 1 gezahnten Seitenvalve 55 x 15 - 23 mm
 52-1374 1 gezahnten Seitenvalve 60 x 15 - 23 mm

Self-retaining retractor, complete, consisting of:
 52-1346 1 Spreader
 52-1370 1 Lateral valve, serrated, 40 x 15 - 23 mm
 52-1371 1 Lateral valve, serrated, 45 x 15 - 23 mm
 52-1372 1 Lateral valve, serrated, 50 x 15 - 23 mm
 52-1373 1 Lateral valve, serrated, 55 x 15 - 23 mm
 52-1374 1 Lateral valve, serrated, 60 x 15 - 23 mm

Separador, completo, compuesto de:
 52-1346 1 Separador
 52-1370 1 Valva lateral, dentada, 40 x 15 - 23 mm
 52-1371 1 Valva lateral, dentada, 45 x 15 - 23 mm
 52-1372 1 Valva lateral, dentada, 50 x 15 - 23 mm
 52-1373 1 Valva lateral, dentada, 55 x 15 - 23 mm
 52-1374 1 Valva lateral, dentada, 60 x 15 - 23 mm

Ecarteur, complet, composé de:
 52-1346 1 Ecarteur
 52-1370 1 Valve latérale, dentelée, 40 x 15 - 23 mm
 52-1371 1 Valve latérale, dentelée, 45 x 15 - 23 mm
 52-1372 1 Valve latérale, dentelée, 50 x 15 - 23 mm
 52-1373 1 Valve latérale, dentelée, 55 x 15 - 23 mm
 52-1374 1 Valve latérale, dentelée, 60 x 15 - 23 mm

Divaricatore, completo, composto da:
 52-1346 1 Divaricatore
 52-1370 1 Valva laterale, dentellata, 40 x 15 - 23 mm
 52-1371 1 Valva laterale, dentellata, 45 x 15 - 23 mm
 52-1372 1 Valva laterale, dentellata, 50 x 15 - 23 mm
 52-1373 1 Valva laterale, dentellata, 55 x 15 - 23 mm
 52-1374 1 Valva laterale, dentellata, 60 x 15 - 23 mm



Laminektomie-Spreizer
Laminectomy Retractors
Separadores para laminectomía
Ecarteurs pour laminectomie
Divaricatori per laminectomia

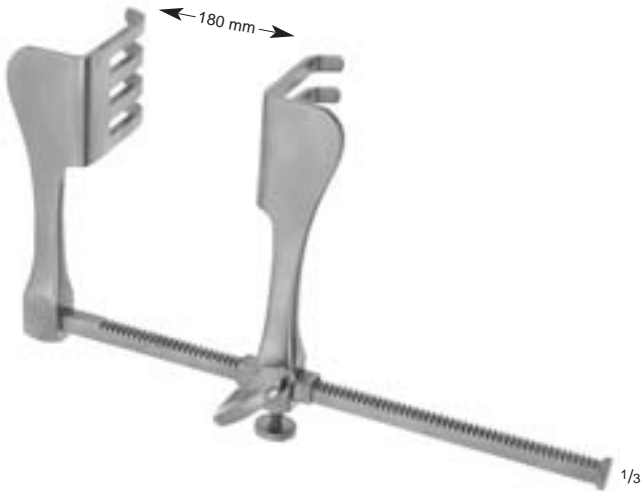
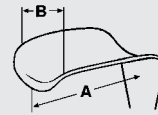

BADGLEY 52-0555

Wundspreizer, Seitenvlaven 52 x 44 mm (AxB)
Self-retaining retractor, lateral valves 52 x 44 mm (AxB)
Separador, valvas laterales 52 x 44 mm (AxB)
Ecarteur, valves latérales 52 x 44 mm (AxB)
Divaricatore, Valve laterali 52 x 44 mm (AxB)

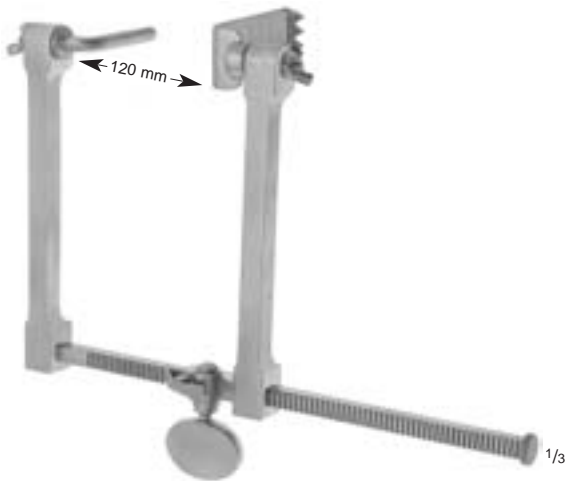

SCOVILLE 52-0583

Wundspreizer, komplett, bestehend aus:
52-0585 1 Rahmen
52-0600 1 Haken 50 mm
52-0610 1 Seitenvalve 63 x 25 mm (AxB)

Self-retaining retractor, complete, consisting of:
52-0585 1 Frame
52-0600 1 Hook 50 mm
52-0610 1 Lateral valve 63 x 25 mm (AxB)

Separador, completo, compuesto de:
52-0585 1 Cuadro
52-0600 1 Gancho 50 mm
52-0610 1 Valva lateral 63 x 25 mm (AxB)

Ecarteur, complet, composé de:
52-0585 1 Cadre
52-0600 1 Crochet 50 mm
52-0610 1 Valve latérale 63 x 25 mm (AxB)

Divaricatore, completo, composto da:
52-0585 1 Telaio
52-0600 1 Divaricatore 50 mm
52-0610 1 Valva laterale 63 x 25 mm (AxB)

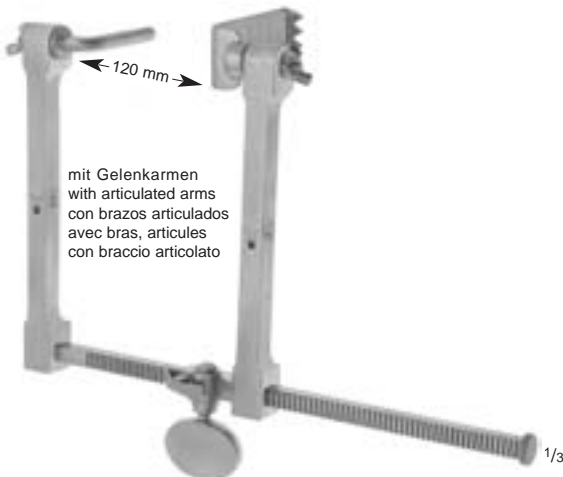

mit Gelenkarmen
with articulated arms
con brazos articulados
avec bras, articulés
con braccio articolato

SCOVILLE-HAVERFIELD 52-0588

Wundspreizer, komplett, bestehend aus:
52-0590 1 Rahmen
52-0600 1 Haken 50 mm
52-0610 1 Seitenvalve 63 x 25 mm (AxB)

Self-retaining retractor, complete, consisting of:
52-0590 1 Frame
52-0600 1 Hook 50 mm
52-0610 1 Lateral valve 63 x 25 mm (AxB)

Separador, completo, compuesto de:
52-0590 1 Cuadro
52-0600 1 Gancho 50 mm
52-0610 1 Valva lateral 63 x 25 mm (AxB)

Ecarteur, complet, composé de:
52-0590 1 Cadre
52-0600 1 Crochet 50 mm
52-0610 1 Valve latérale 63 x 25 mm (AxB)

Divaricatore, completo, composto da:
52-0590 1 Telaio
52-0600 1 Divaricatore 50 mm
52-0610 1 Valva laterale 63 x 25 mm (AxB)

Haken
Hooks
Ganchos
Crochets
Ganci

Seitenvalven
Lateral Valves
Valvas laterales
Valves latérales
Valve laterali

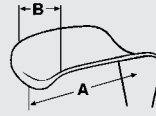

SCOVILLE

- ▶ 52-0600 50 mm
- 52-0601 75 mm

Haken für Wundspreizer
52-0583 und 52-0588

Hooks for self-retaining
retractors 52-0583 and 52-0588

Ganchos para separadores
52-0583 y 52-0588

Crochet pour écarteurs
52-0583 et 52-0588

Gancio per divaricatori
52-0583 e 52-0588



SCOVILLE

- 52-0610 63 x 25 mm (AxB)
- 52-0611 63 x 50 mm (AxB)
- ▶ 52-0613 88 x 25 mm (AxB)

Seitenvalven für Wundspreizer
52-0583 und 52-0588

Lateral valves for self-retaining
retractors 52-0583 and 52-0588

Valvas laterales para separadores
52-0583 y 52-0588

Valves latérales pour écarteurs
52-0583 et 52-0588

Valve laterali per divaricatori
52-0583 e 52-0588



SCOVILLE

- ▶ 52-0620 41 x 38 mm (AxB)
- 52-0621 67 x 44 mm (AxB)

Seitenvalven für Wundspreizer
52-0583 und 52-0588

Lateral valves for self-retaining
retractors 52-0583 and 52-0588

Valvas laterales para separadores
52-0583 y 52-0588

Valves latérales pour écarteurs
52-0583 et 52-0588

Valve laterali per divaricatori
52-0583 e 52-0588



TAYLOR

- 52-0685 48 x 50 mm (AxB)
- ▶ 52-0686 64 x 63 mm (AxB)
- 52-0687 80 x 57 mm (AxB)

Seitenvalven für Wundspreizer
52-0583 und 52-0588

Lateral valves for self-retaining
retractors 52-0583 and 52-0588

Valvas laterales para separadores
52-0583 y 52-0588

Valves latérales pour écarteurs
52-0583 et 52-0588

Valve laterali per divaricatori
52-0583 e 52-0588



Wundspreizer für die Wirbelsäule
Retractors for vertebral column
Separadores para la columna vertebral
Ecarteurs pour colonne vertébrale
Divaricatori per colonna vertebrale

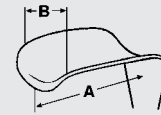

Lumbal, thorakal und cervical einzusetzen!
For use of lumbar, thoracic and cervical!
Útil para lumbar, toracal y cervical!
Pour utilisation lombaire thoracique et cervicale!
Per impiego lombare, toracico e cervicale

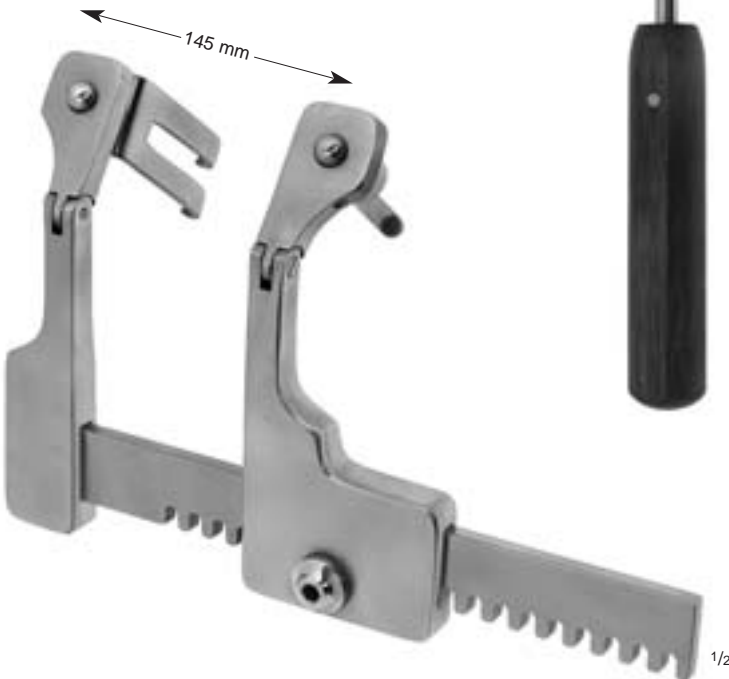

CASPAR
52-0700

Wundspreizer mit Gelenkarmen und Kugelschnellverschluss, für Laminektomie und Hemi-Laminektomie, komplett, bestehend aus:
52-0701 1 Rahmen
52-0702 1 Drehschlüssel
52-0705 1 Haken 38 mm
52-0711 1 Seitenvalve 37 x 22 mm
52-0712 1 Seitenvalve 43 x 22 mm
52-0713 1 Seitenvalve 47 x 22 mm
52-0714 1 Seitenvalve 52 x 22 mm
52-0715 1 Seitenvalve 57 x 22 mm

Ecarteur avec bras articulés, enclenchement à billes, pour laminectomie et hémi-laminectomie, complet composé de:
52-0701 1 Cadre
52-0702 1 Clef
52-0705 1 Crochet 38 mm
52-0711 1 Valve latérale 37 x 22 mm
52-0712 1 Valve latérale 43 x 22 mm
52-0713 1 Valve latérale 47 x 22 mm
52-0714 1 Valve latérale 52 x 22 mm
52-0715 1 Valve latérale 57 x 22 mm

Self-retaining retractor with articulated arms and ball snap closure, for laminectomy and hemi-laminectomy, complete, consisting of:
52-0701 1 Frame
52-0702 1 Key
52-0705 1 Hook 38 mm
52-0711 1 Lateral valve 37 x 22 mm
52-0712 1 Lateral valve 43 x 22 mm
52-0713 1 Lateral valve 47 x 22 mm
52-0714 1 Lateral valve 52 x 22 mm
52-0715 1 Lateral valve 57 x 22 mm

Divaricatore con braccio articolato a chiusura istantanea, per laminectomia e emi-laminectomia, completo, composto da:
52-0701 1 Telaio
52-0702 1 Chiave
52-0705 1 Gancio 38 mm
52-0711 1 Valva laterale 37 x 22 mm
52-0712 1 Valva laterale 43 x 22 mm
52-0713 1 Valva laterale 47 x 22 mm
52-0714 1 Valva laterale 52 x 22 mm
52-0715 1 Valva laterale 57 x 22 mm



52-0705
38 mm



52-0711
37 x 22 mm (AxB)



52-0712
43 x 22 mm (AxB)



52-0713
47 x 22 mm (AxB)



52-0714
52 x 22 mm (AxB)



52-0715
57 x 22 mm (AxB)

Separador con brazos articulados y cierre rápido esférico, para laminectomia y hemilaminectomia, completo, compuesto de:
52-0701 1 Cuadro
52-0702 1 Llave
52-0705 1 Gancho 38 mm
52-0711 1 Valva lateral 37 x 22 mm
52-0712 1 Valva lateral 43 x 22 mm
52-0713 1 Valva lateral 47 x 22 mm
52-0714 1 Valva lateral 52 x 22 mm
52-0715 1 Valva lateral 57 x 22 mm

Haken
Hooks
Ganchos
Crochets
Ganci

Seitenvalven
Lateral Valves
Valvas laterales
Valves latérales
Valve laterali

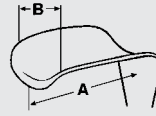

- 52-0705 38 mm
▶ 52-0706 58 mm

Haken mit Kugelschnellverschluss,
für Wundspreizer 52-0700

Hooks with ball snap closure, for
self-retaining retractor 52-0700

Ganchos con cierre rápido esférico
para separador 52-0700

Crochets avec enclenchement à billes
pour écarteur 52-0700

Ganci a chiusura istantanea per
divaricatore 52-0700



- 52-0710 32 x 22 mm (AxB)
52-0711 37 x 22 mm (AxB)
52-0712 43 x 22 mm (AxB)
52-0713 47 x 22 mm (AxB)
52-0714 52 x 22 mm (AxB)
▶ 52-0715 57 x 22 mm (AxB)
52-0716 62 x 22 mm (AxB)
52-0717 67 x 22 mm (AxB)

Seitenvalven mit Kugelschnellverschluss,
für Wundspreizer 52-0700

Lateral valves with ball snap closure, for
self-retaining retractor 52-0700

Valvas laterales con cierre rápido
esférico para separador 52-0700

Valves latérales avec enclenchement à
billes, pour écarteur 52-0700

Valve laterali a chiusura istantanea
per divaricatore 52-0700



- 52-0720 32 x 37 mm (AxB)
52-0721 37 x 37 mm (AxB)
52-0722 43 x 37 mm (AxB)
52-0723 47 x 37 mm (AxB)
52-0724 52 x 37 mm (AxB)
▶ 52-0725 57 x 37 mm (AxB)
52-0726 62 x 37 mm (AxB)
52-0727 67 x 37 mm (AxB)

Seitenvalven mit Kugelschnellverschluss,
für Wundspreizer 52-0700

Lateral valves with ball snap closure, for
self-retaining retractor 52-0700

Valvas laterales con cierre rápido
esférico para separador 52-0700

Valves latérales avec enclenchement à
billes, pour écarteur 52-0700

Valve laterali a chiusura istantanea
per divaricatore 52-0700



- 52-0730 32 x 52 mm (AxB)
52-0731 37 x 52 mm (AxB)
52-0732 43 x 52 mm (AxB)
52-0733 47 x 52 mm (AxB)
52-0734 52 x 52 mm (AxB)
▶ 52-0735 57 x 52 mm (AxB)
52-0736 62 x 52 mm (AxB)
52-0737 67 x 52 mm (AxB)

Seitenvalven mit Kugelschnellverschluss,
für Wundspreizer 52-0700

Lateral valves with ball snap closure, for
self-retaining retractor 52-0700

Valvas laterales con cierre rápido
esférico para separador 52-0700

Valves latérales avec enclenchement à
billes, pour écarteur 52-0700

Valve laterali a chiusura istantanea
per divaricatore 52-0700



- 52-0739
11,5 cm, 4 1/2"

Pinzette zum Valvenwechsel bei
Kugelschnellverschluss-System

Valve ejector for changing the valves
with ball snap closure system

Pinza para el cambio de valvas con el
sistema de cierre rápido esférico

Pince pour changer les valves avec
système à billes

Pinza per il cambio delle valve a
chiusura istantanea



Wundspreizer für die cervicale Wirbelsäule
 Retractors for cervical vertebral column
 Separadores para la columna cervical
 Ecarteurs pour colonne vertébrale
 Divaricatori per colonna cervicale

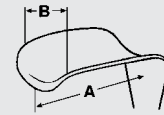

In Wirbelsäulen-Längsachse zu verwenden!
 To be used for up and down retraction!
 Útil para el eje longitudinal de la columna vertebral!
 Utilisé du haut en bas de la colonne vertébrale!
 Da impiegarsi per la trazione e la compressione della colonna!

← 90 mm →



CASPAR
 52-0740
 16,5 cm, 6 1/2"

Wundspreizer mit Gelenkarmen und Kugelschnellverschluss, komplett, bestehend aus:
 52-0742 1 Sperrer
 52-0780 1 stumpfen Valve 45 x 23 mm
 52-0781 1 stumpfen Valve 50 x 23 mm
 52-0782 1 stumpfen Valve 55 x 23 mm
 52-0783 1 stumpfen Valve 60 x 23 mm
 52-0784 1 stumpfen Valve 65 x 23 mm

Self-retaining retractor with articulated arms and ball snap closure, complete, consisting of:
 52-0742 1 Spreader
 52-0780 1 Blunt valve 45 x 23 mm
 52-0781 1 Blunt valve 50 x 23 mm
 52-0782 1 Blunt valve 55 x 23 mm
 52-0783 1 Blunt valve 60 x 23 mm
 52-0784 1 Blunt valve 65 x 23 mm

Separador con brazos articulados y cierre rápido esférico, completo, compuesto de:
 52-0742 1 Separador
 52-0780 1 Valva roma 45 x 23 mm
 52-0781 1 Valva roma 50 x 23 mm
 52-0782 1 Valva roma 55 x 23 mm
 52-0783 1 Valva roma 60 x 23 mm
 52-0784 1 Valva roma 65 x 23 mm

Ecarteur avec bras articulés, enclenchement à billes, complet composé de:
 52-0742 1 Ecarteur
 52-0780 1 Valve, mousse 45 x 23 mm
 52-0781 1 Valve, mousse 50 x 23 mm
 52-0782 1 Valve, mousse 55 x 23 mm
 52-0783 1 Valve, mousse 60 x 23 mm
 52-0784 1 Valve, mousse 65 x 23 mm

Divaricatore con braccio articolato a chiusura istantanea, completo, composto da:
 52-0742 1 Divaricatore
 52-0780 1 Valva, smussa 45 x 23 mm
 52-0781 1 Valva, smussa 50 x 23 mm
 52-0782 1 Valva, smussa 55 x 23 mm
 52-0783 1 Valva, smussa 60 x 23 mm
 52-0784 1 Valva, smussa 65 x 23 mm



52-0780
 45 x 23 mm (AxB)



52-0781
 50 x 23 mm (AxB)



52-0782
 55 x 23 mm (AxB)



52-0783
 60 x 23 mm (AxB)



52-0784
 65 x 23 mm (AxB)

Wundspreizer für die cervicale Wirbelsäule
 Retractors for cervical vertebral column
 Separadores para la columna cervical
 Ecarteurs pour colonne vertébrale
 Divaricatori per colonna cervicale

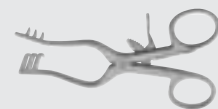
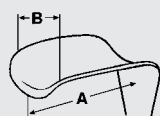

In Wirbelsäulen-Längsachse zu verwenden!
 To be used for up and down retraction!
 Útil para el eje longitudinal de la columna vertebral!
 Utilisé du haut en bas de la colonne vertébrale!
 Da impiegarsi per la trazione e la compressione della colonna!



52-0780
 45 x 23 mm (AxB)



52-0781
 50 x 23 mm (AxB)



52-0782
 55 x 23 mm (AxB)



52-0783
 60 x 23 mm (AxB)



52-0784
 65 x 23 mm (AxB)

← 85 mm →



CASPAR
 52-0745
 10,5 cm, 4 1/8"

Wundspreizer mit Gelenkarmen und Kugelschnellverschluss, komplett, bestehend aus:
 52-0746 1 Sperrer
 52-0780 1 stumpfen Valve 45 x 23 mm
 52-0781 1 stumpfen Valve 50 x 23 mm
 52-0782 1 stumpfen Valve 55 x 23 mm
 52-0783 1 stumpfen Valve 60 x 23 mm
 52-0784 1 stumpfen Valve 65 x 23 mm

Self-retaining retractor with articulated arms and ball snap closure, complete, consisting of:
 52-0746 1 Spreader
 52-0780 1 Blunt valve 45 x 23 mm
 52-0781 1 Blunt valve 50 x 23 mm
 52-0782 1 Blunt valve 55 x 23 mm
 52-0783 1 Blunt valve 60 x 23 mm
 52-0784 1 Blunt valve 65 x 23 mm

Separador con brazos articulados y cierre rápido esférico, completo, compuesto de:
 52-0746 1 Separador
 52-0780 1 Valva roma 45 x 23 mm
 52-0781 1 Valva roma 50 x 23 mm
 52-0782 1 Valva roma 55 x 23 mm
 52-0783 1 Valva roma 60 x 23 mm
 52-0784 1 Valva roma 65 x 23 mm

Ecarteur avec bras articulés, enclenchement à billes, complet composé de:
 52-0746 1 Ecarteur
 52-0780 1 Valve, mousse 45 x 23 mm
 52-0781 1 Valve, mousse 50 x 23 mm
 52-0782 1 Valve, mousse 55 x 23 mm
 52-0783 1 Valve, mousse 60 x 23 mm
 52-0784 1 Valve, mousse 65 x 23 mm

Divaricatore con braccio articolato a chiusura istantanea, completo, composto da:
 52-0746 1 Divaricatore
 52-0780 1 Valva, smussa 45 x 23 mm
 52-0781 1 Valva, smussa 50 x 23 mm
 52-0782 1 Valva, smussa 55 x 23 mm
 52-0783 1 Valva, smussa 60 x 23 mm
 52-0784 1 Valva, smussa 65 x 23 mm



Wundspreizer für die cervicale Wirbelsäule
 Retractors for cervical vertebral column
 Separadores para la columna cervical
 Ecarteurs pour colonne vertébrale
 Divaricatori per colonna cervicale

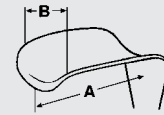

52-0770
40 x 23 mm (AxB)



52-0775
40 x 23 mm (AxB)



52-0771
45 x 23 mm (AxB)



52-0776
45 x 23 mm (AxB)



52-0772
50 x 23 mm (AxB)



52-0777
50 x 23 mm (AxB)



52-0773
55 x 23 mm (AxB)



52-0778
55 x 23 mm (AxB)



52-0774
60 x 23 mm (AxB)



52-0779
60 x 23 mm (AxB)



CASPAR
52-0750

Wundspreizer mit Gelenkarmen und Kugelschnellverschluss, komplett, bestehend aus:

- 52-0751 1 Rahmen
- 52-0770 1 medialen Valve 40 x 23 mm
- 52-0771 1 medialen Valve 45 x 23 mm
- 52-0772 1 medialen Valve 50 x 23 mm
- 52-0773 1 medialen Valve 55 x 23 mm
- 52-0774 1 medialen Valve 60 x 23 mm
- 52-0775 1 lateralen Valve 40 x 23 mm
- 52-0776 1 lateralen Valve 45 x 23 mm
- 52-0777 1 lateralen Valve 50 x 23 mm
- 52-0778 1 lateralen Valve 55 x 23 mm
- 52-0779 1 lateralen Valve 60 x 23 mm

Self-retaining retractor with articulated arms and ball snap closure, complete, consisting of:

- 52-0751 1 Frame
- 52-0770 1 Medial valve 40 x 23 mm
- 52-0771 1 Medial valve 45 x 23 mm
- 52-0772 1 Medial valve 50 x 23 mm
- 52-0773 1 Medial valve 55 x 23 mm
- 52-0774 1 Medial valve 60 x 23 mm
- 52-0775 1 Lateral valve 40 x 23 mm
- 52-0776 1 Lateral valve 45 x 23 mm
- 52-0777 1 Lateral valve 50 x 23 mm
- 52-0778 1 Lateral valve 55 x 23 mm
- 52-0779 1 Lateral valve 60 x 23 mm

Separador con brazos articulados y cierre rápido esférico, completo, compuesto de:

- 52-0751 1 Cuadro
- 52-0770 1 Valva mediana 40 x 23 mm
- 52-0771 1 Valva mediana 45 x 23 mm
- 52-0772 1 Valva mediana 50 x 23 mm
- 52-0773 1 Valva mediana 55 x 23 mm
- 52-0774 1 Valva mediana 60 x 23 mm
- 52-0775 1 Valva lateral 40 x 23 mm
- 52-0776 1 Valva lateral 45 x 23 mm
- 52-0777 1 Valva lateral 50 x 23 mm
- 52-0778 1 Valva lateral 55 x 23 mm
- 52-0779 1 Valva lateral 60 x 23 mm

Ecarteur avec bras articulés, enclenchement à billes, complet composé de:

- 52-0751 1 Cadre
- 52-0770 1 Valve médiane 40 x 23 mm
- 52-0771 1 Valve médiane 45 x 23 mm
- 52-0772 1 Valve médiane 50 x 23 mm
- 52-0773 1 Valve médiane 55 x 23 mm
- 52-0774 1 Valve médiane 60 x 23 mm
- 52-0775 1 Valve latérale 40 x 23 mm
- 52-0776 1 Valve latérale 45 x 23 mm
- 52-0777 1 Valve latérale 50 x 23 mm
- 52-0778 1 Valve latérale 55 x 23 mm
- 52-0779 1 Valve latérale 60 x 23 mm

Divaricatore con braccio articolato a chiusura istantanea, completo, composto da:

- 52-0751 1 Telaio
- 52-0770 1 Valva media 40 x 23 mm
- 52-0771 1 Valva media 45 x 23 mm
- 52-0772 1 Valva media 50 x 23 mm
- 52-0773 1 Valva media 55 x 23 mm
- 52-0774 1 Valva media 60 x 23 mm
- 52-0775 1 Valva laterale 40 x 23 mm
- 52-0776 1 Valva laterale 45 x 23 mm
- 52-0777 1 Valva laterale 50 x 23 mm
- 52-0778 1 Valva laterale 55 x 23 mm
- 52-0779 1 Valva laterale 60 x 23 mm

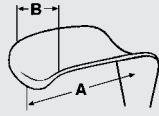

- 52-0770 40 x 23 mm (AxB)
- 52-0771 45 x 23 mm (AxB)
- 52-0772 50 x 23 mm (AxB)
- 52-0773 55 x 23 mm (AxB)
- 52-0774 60 x 23 mm (AxB)

Mediale Valven mit Kugelschnellverschluss, für Wundspreizer
52-0740 / 52-0745 / 52-0750

Medial valves with ball snap closure, for self-retaining retractors
52-0740 / 52-0745 / 52-0750

Valvas medianas con cierre rápido esférico, para separadores
52-0740 / 52-0745 / 52-0750

Valves médianes avec enclenchement à bille, pour écarteurs
52-0740 / 52-0745 / 52-0750

Valve medie a chiusura istantanea, per divaricatori
52-0740 / 52-0745 / 52-0750



- 52-0775 40 x 23 mm (AxB)
- 52-0776 45 x 23 mm (AxB)
- 52-0777 50 x 23 mm (AxB)
- 52-0778 55 x 23 mm (AxB)
- 52-0779 60 x 23 mm (AxB)

Laterale Valven mit Kugelschnellverschluss, für Wundspreizer
52-0740 / 52-0745 / 52-0750

Lateral valves with ball snap closure, for self-retaining retractors
52-0740 / 52-0745 / 52-0750

Valvas laterales con cierre rápido esférico, para separadores
52-0740 / 52-0745 / 52-0750

Valves latérales avec enclenchement à bille, pour écarteurs
52-0740 / 52-0745 / 52-0750

Valve laterali a chiusura istantanea, per divaricatori
52-0740 / 52-0745 / 52-0750



- 52-0780 45 x 23 mm (AxB)
- 52-0781 50 x 23 mm (AxB)
- 52-0782 55 x 23 mm (AxB)
- 52-0783 60 x 23 mm (AxB)
- 52-0784 65 x 23 mm (AxB)

Stumpfe Valven mit Kugelschnellverschluss, für Wundspreizer
52-0740 / 52-0745 / 52-0750

Blunt valves with ball snap closure, for self-retaining retractors
52-0740 / 52-0745 / 52-0750

Valvas romas con cierre rápido esférico, para separadores
52-0740 / 52-0745 / 52-0750

Valves mousses avec enclenchement à bille, pour écarteurs
52-0740 / 52-0745 / 52-0750

Valve smusse a chiusura istantanea, per divaricatori
52-0740 / 52-0745 / 52-0750



- 52-0785 50 x 25 mm (AxB)
- 52-0786 60 x 25 mm (AxB)

Stumpfe Valven mit Kugelschnellverschluss zur Spanentnahme am Beckenkamm, für Wundspreizer
52-0740 / 52-0745 / 52-0750

Blunt valves with ball snap closure, for harvesting of the fusion graft from the iliac crest, for self-retaining retractors
52-0740 / 52-0745 / 52-0750

Valvas romas con cierre rápido esférico, para separadores
52-0740 / 52-0745 / 52-0750

Valves mousses avec enclenchement à bille, pour écarteurs
52-0740 / 52-0745 / 52-0750

Valve smusse a chiusura istantanea, per osso iliaco, per divaricatori
52-0740 / 52-0745 / 52-0750



- 52-0790 40 x 25 mm (AxB)
- 52-0791 45 x 25 mm (AxB)
- 52-0792 50 x 25 mm (AxB)
- 52-0793 55 x 25 mm (AxB)
- 52-0794 60 x 25 mm (AxB)

Mediale Valven aus TITAN, mit Kugelschnellverschluss, für Wundspreizer
52-0740 / 52-0745 / 52-0750

Medial valves of TITANIUM, with ball snap closure, for self-retaining retractors
52-0740 / 52-0745 / 52-0750

Valvas medianas de TITANIO, con cierre rápido esférico, para separadores
52-0740 / 52-0745 / 52-0750

Valves medianes TITANE avec enclenchement à bille, pour écarteurs
52-0740 / 52-0745 / 52-0750

Valve medie in TITANO a chiusura istantanea, per divaricatori
52-0740 / 52-0745 / 52-0750



- 52-0795 40 x 25 mm (AxB)
- 52-0796 45 x 25 mm (AxB)
- 52-0797 50 x 25 mm (AxB)
- 52-0798 55 x 25 mm (AxB)
- 52-0799 60 x 25 mm (AxB)

Laterale Valven aus TITAN, mit Kugelschnellverschluss, für Wundspreizer
52-0740 / 52-0745 / 52-0750

Lateral valves of TITANIUM, with ball snap closure, for self-retaining retractors
52-0740 / 52-0745 / 52-0750

Valvas laterales de TITANIO, con cierre rápido esférico, para separadores
52-0740 / 52-0745 / 52-0750

Valves latérales TITANE avec enclenchement à bille, pour écarteurs
52-0740 / 52-0745 / 52-0750

Valve laterali in TITANO, a chiusura istantanea, per divaricatori
52-0740 / 52-0745 / 52-0750



Wundspreizer für die lumbale Wirbelsäule
 Retractors for lumbar vertebral column
 Separadores para la cirugía lumbar vertebral
 Ecarteurs pour chirurgie lombaire
 Divaricatori per colonna lombo vertebrale

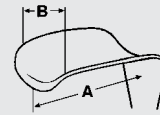

Oberfläche geschwärzt
 Surface black-finish
 Superficie negra
 Surface noire
 Superficie nera

← 60 mm →



CASPAR
52-0800

Wundspreizer mit Gelenkarmen und Kugelschnellverschluß, komplett, bestehend aus:
 52-0801 1 Rahmen
 52-0802 1 Seitenvalve 40 x 12 mm
 52-0803 1 Seitenvalve 46 x 13 mm
 52-0804 1 Seitenvalve 50 x 13 mm
 52-0805 1 Seitenvalve 56 x 14 mm
 52-0806 1 Seitenvalve 63 x 14 mm
 52-0807 1 Seitenvalve 66 x 15 mm

Ecarteur avec bras articulés, enclenchement à billes, complet composé de:
 52-0801 1 Cadre
 52-0802 1 Valve latérale 40 x 12 mm
 52-0803 1 Valve latérale 46 x 13 mm
 52-0804 1 Valve latérale 50 x 13 mm
 52-0805 1 Valve latérale 56 x 14 mm
 52-0806 1 Valve latérale 63 x 14 mm
 52-0807 1 Valve latérale 66 x 15 mm

Self-retaining retractor with articulated arms and ball snap closure, complete, consisting of:
 52-0801 1 Frame
 52-0802 1 Lateral valve 40 x 12 mm
 52-0803 1 Lateral valve 46 x 13 mm
 52-0804 1 Lateral valve 50 x 13 mm
 52-0805 1 Lateral valve 56 x 14 mm
 52-0806 1 Lateral valve 63 x 14 mm
 52-0807 1 Lateral valve 66 x 15 mm

Divaricatore con braccio articolato a chiusura istantanea, completo, composto da:
 52-0801 1 Telaio
 52-0802 1 Valva laterale 40 x 12 mm
 52-0803 1 Valva laterale 46 x 13 mm
 52-0804 1 Valva laterale 50 x 13 mm
 52-0805 1 Valva laterale 56 x 14 mm
 52-0806 1 Valva laterale 63 x 14 mm
 52-0807 1 Valva laterale 66 x 15 mm



52-0802
 40 x 12 mm (AxB)



52-0803
 46 x 13 mm (AxB)



52-0804
 50 x 13 mm (AxB)



52-0805
 56 x 14 mm (AxB)



52-0806
 63 x 14 mm (AxB)



52-0807
 66 x 15 mm (AxB)

Spekula für lumbale Bandscheibenoperationen
 Specula for lumbar vertebral operations
 Espéculos para la cirugía lumbar vertebral
 Spéculums pour chirurgie lombaire
 Speculi per chirurgia lombo vertebrale

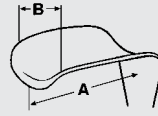

▶ 52-0810
40 x 18 mm (AxB)

1/1



52-0812
45 x 18 mm (AxB)

1/1



52-0814
50 x 18 mm (AxB)

1/1



52-0816
55 x 18 mm (AxB)

1/1



52-0818
60 x 18 mm (AxB)

1/1



1/2

CASPAR
52-0810
- 52-0818
15 cm, 6"

Oberfläche geschwärzt
 Surface black-finish
 Superficie negra
 Surface noire
 Superficie nera



Wirbelkörperspreizer
 Lamina Spreaders
 Separadores para cuerpos vertebrales
 Ecarteurs pour corps vertébraux
 Separatori per vertebre



CLOWARD
 52-1301
 16 cm, 6 1/4"
 Spreizweite 18 mm
 Blade opening 18 mm
 Abertura de la hoja 18 mm
 Écartement 18 mm
 Apertura lame 18 mm



INGE
 52-0517
 16 cm, 6 1/4"
 Spreizweite 34 mm
 Blade opening 34 mm
 Abertura de la hoja 34 mm
 Écartement 34 mm
 Apertura lame 34 mm

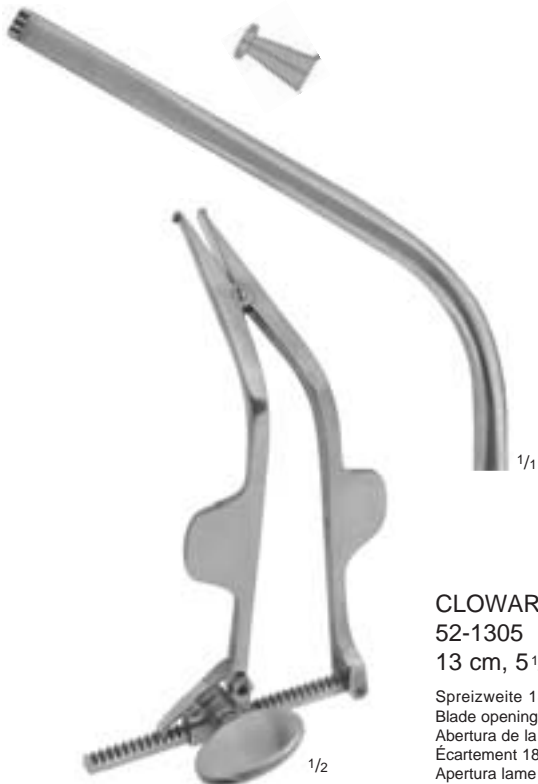

CLOWARD
 52-1305
 13 cm, 5 1/8"
 Spreizweite 18 mm
 Blade opening 18 mm
 Abertura de la hoja 18 mm
 Écartement 18 mm
 Apertura lame 18 mm



INGE
 52-0516
 26,5 cm, 10 1/2"
 Spreizweite 63 mm
 Blade opening 63 mm
 Abertura de la hoja 63 mm
 Écartement 63 mm
 Apertura lame 63 mm



BABY-COLLIN
21-0340
18 cm, 7"

Bauchdeckenhalter, komplett,
bestehend aus:

- 21-0341 1 Sperrer
- 21-0345 1 Paar Seitenvalven
18 x 40 mm (AxB)
- 21-0346 1 Paar Seitenvalven
28 x 40 mm (AxB)

Abdominal retractor, complete,
consisting of:

- 21-0341 1 Spreader
- 21-0345 1 Pair lateral valves
18 x 40 mm (AxB)
- 21-0346 1 Pair lateral valves
28 x 40 mm (AxB)

Separador abdominal, completo,
compuesto de:

- 21-0341 1 Separador
- 21-0345 1 Par de valvas laterales
18 x 40 mm (AxB)
- 21-0346 1 Par de valvas laterales
28 x 40 mm (AxB)

Ecarteur abdominal, complet,
composé de:

- 21-0341 1 Ecarteur
- 21-0345 1 Paire de valves latérales
18 x 40 mm (AxB)
- 21-0346 1 Paire de valves latérales
28 x 40 mm (AxB)

Divaricatore addominale, completo,
composto da:

- 21-0341 1 Divaricatore
- 21-0345 1 Paio di valve laterali
18 x 40 mm (AxB)
- 21-0346 1 Paio di valve laterali
28 x 40 mm (AxB)



COLLIN
21-0350
23 cm, 9"

Bauchdeckenhalter, komplett,
bestehend aus:

- 21-0351 1 Sperrer
- 21-0352 1 Paar Seitenvalven
40 x 63 mm (AxB)

Abdominal retractor, complete,
consisting of:

- 21-0351 1 Spreader
- 21-0352 1 Pair lateral valves
40 x 63 mm (AxB)

Separador abdominal, completo,
compuesto de:

- 21-0351 1 Separador
- 21-0352 1 Par de valvas laterales
40 x 63 mm (AxB)

Ecarteur abdominal, complet,
composé de:

- 21-0351 1 Ecarteur
- 21-0352 1 Paire de valves latérales
40 x 63 mm (AxB)

Divaricatore addominale, completo,
composto da:

- 21-0351 1 Divaricatore
- 21-0352 1 Paio di valve laterali
40 x 63 mm (AxB)



COLLIN
21-0356
24 cm, 9 1/2"

Bauchdeckenhalter, komplett,
bestehend aus:

- 21-0358 1 Sperrer
- 21-0378 1 Paar Seitenvalven
40 x 80 mm (AxB)
- 21-0379 1 Mittelvalve
54 x 65 mm (AxB)

Abdominal retractor, complete,
consisting of:

- 21-0358 1 Spreader
- 21-0378 1 Pair lateral valves
40 x 80 mm (AxB)
- 21-0379 1 Central valve
54 x 65 mm (AxB)

Separador abdominal, completo,
compuesto de:

- 21-0358 1 Separador
- 21-0378 1 Par de valvas laterales
40 x 80 mm (AxB)
- 21-0379 1 Valva central
54 x 65 mm (AxB)

Ecarteur abdominal, complet,
composé de:

- 21-0358 1 Ecarteur
- 21-0378 1 Paire de valves latérales
40 x 80 mm (AxB)
- 21-0379 1 Valve centrale
54 x 65 mm (AxB)

Divaricatore addominale, completo,
composto da:

- 21-0341 1 Divaricatore
- 21-0345 1 Paio di valve laterali
40 x 80 mm (AxB)
- 21-0346 1 Valva centrale
54 x 65 mm (AxB)



COLLIN
21-0357
25 cm, 10"

Bauchdeckenhalter, komplett,
bestehend aus:

- 21-0358 1 Sperrer
- 21-0382 1 Paar Seitenvalven
40 x 100 mm (AxB)
- 21-0383 1 Mittelvalve
54 x 76 mm (AxB)

Abdominal retractor, complete,
consisting of:

- 21-0358 1 Spreader
- 21-0382 1 Pair lateral valves
40 x 100 mm (AxB)
- 21-0383 1 Central valve
54 x 76 mm (AxB)

Separador abdominal, completo,
compuesto de:

- 21-0358 1 Separador
- 21-0382 1 Par de valvas laterales
40 x 100 mm (AxB)
- 21-0383 1 Valva central
54 x 76 mm (AxB)

Ecarteur abdominal, complet,
composé de:

- 21-0358 1 Ecarteur
- 21-0382 1 Paire de valves latérales
40 x 100 mm (AxB)
- 21-0383 1 Valve centrale
54 x 76 mm (AxB)

Divaricatore addominale, completo,
composto da:

- 21-0358 1 Divaricatore
- 21-0382 1 Paio di valve laterali
40 x 100 mm (AxB)
- 21-0383 1 Valva centrale
54 x 76 mm (AxB)



Bauchdeckenhalter
Abdominal Retractors
Separadores abdominales
Ecarteurs abdominaux
Divaricatori addominali

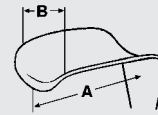

COLLIN
21-0361
32 cm, 12 1/2"

Bauchdeckenhalter, komplett, bestehend aus:
21-0362 1 Sperrer
21-0388 1 Paar Seitenvalven 58 x 80 mm (AxB)
21-0387 1 Mittelvalve 63 x 73 mm (AxB)

Abdominal retractor, complete, consisting of:
21-0362 1 Spreader
21-0388 1 Pair lateral valves 58 x 80 mm (AxB)
21-0387 1 Central valve 63 x 73 mm (AxB)

Separador abdominal, completo, compuesto de:
21-0362 1 Separador
21-0388 1 Par de valvas laterales 58 x 80 mm (AxB)
21-0387 1 Valva central 63 x 73 mm (AxB)

Ecarteur abdominal, complet, composé de:
21-0362 1 Ecarteur
21-0388 1 Paire de valves latérales 58 x 80 mm (AxB)
21-0387 1 Valve centrale 63 x 73 mm (AxB)

Divaricatore addominale, completo, composto da:
21-0362 1 Divaricatore
21-0388 1 Paio di valve laterali 58 x 80 mm (AxB)
21-0387 1 Valva centrale 63 x 73 mm (AxB)



RICARD
21-0380

Bauchdeckenhalter, komplett, bestehend aus:
21-0384 1 Sperrer
21-0396 1 Paar Seitenvalven 58 x 80 mm (AxB)
21-0397 1 Mittelvalve 54 x 70 mm (AxB)

Abdominal retractor, complete, consisting of:
21-0384 1 Spreader
21-0396 1 Pair lateral valves 58 x 80 mm (AxB)
21-0397 1 Central valve 54 x 70 mm (AxB)

Separador abdominal, completo, compuesto de:
21-0384 1 Separador
21-0396 1 Par de valvas laterales 58 x 80 mm (AxB)
21-0397 1 Valva central 54 x 70 mm (AxB)

Ecarteur abdominal, complet, composé de:
21-0384 1 Ecarteur
21-0396 1 Paire de valves latérales 58 x 80 mm (AxB)
21-0397 1 Valve centrale 54 x 70 mm (AxB)

Divaricatore addominale, completo, composto da:
21-0384 1 Divaricatore
21-0396 1 Paio di valve laterali 58 x 80 mm (AxB)
21-0397 1 Valva centrale 54 x 70 mm (AxB)



RICARD
21-0381

Bauchdeckenhalter, komplett, bestehend aus:
21-0389 1 Sperrer
21-0398 1 Paar Seitenvalven 72 x 85 mm (AxB)
21-0399 1 Mittelvalve 72 x 90 mm (AxB)

Abdominal retractor, complete, consisting of:
21-0389 1 Spreader
21-0398 1 Pair lateral valves 72 x 85 mm (AxB)
21-0399 1 Central valve 72 x 90 mm (AxB)

Separador abdominal, completo, compuesto de:
21-0389 1 Separador
21-0398 1 Par de valvas laterales 72 x 85 mm (AxB)
21-0399 1 Valva central 72 x 90 mm (AxB)

Ecarteur abdominal, complet, composé de:
21-0389 1 Ecarteur
21-0398 1 Paire de valves latérales 72 x 85 mm (AxB)
21-0399 1 Valve centrale 72 x 90 mm (AxB)

Divaricatore addominale, completo, composto da:
21-0389 1 Divaricatore
21-0398 1 Paio di valve laterali 72 x 85 mm (AxB)
21-0399 1 Valva centrale 72 x 90 mm (AxB)

Bauchdeckenhalter
Abdominal Retractors
Separadores abdominales
Ecarteurs abdominaux
Divaricatori addominali

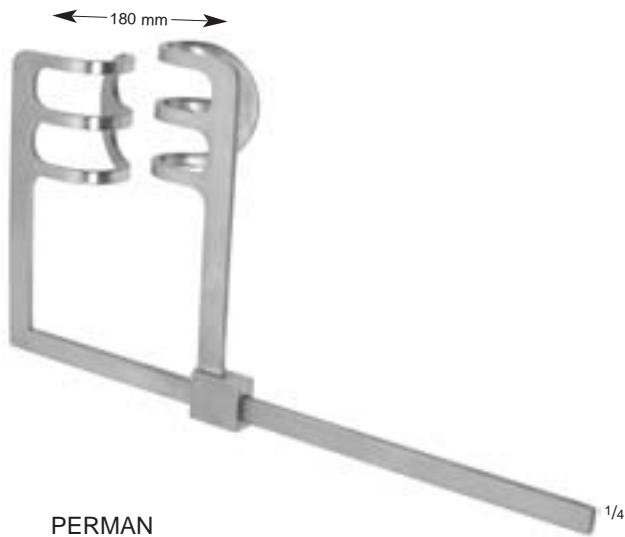
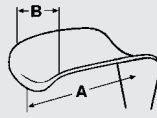

PERMAN
21-0465

Bauchdeckenhalter, Seitenventilen
60 x 60 mm (AxB)

Abdominal retractor, lateral valves
60 x 60 mm (AxB)

Separador abdominal, valvas laterales
60 x 60 mm (AxB)

Ecarteur abdominal, valves latérales
60 x 60 mm (AxB)

Divaricatore addominale, valve laterali
60 x 60 mm (AxB)

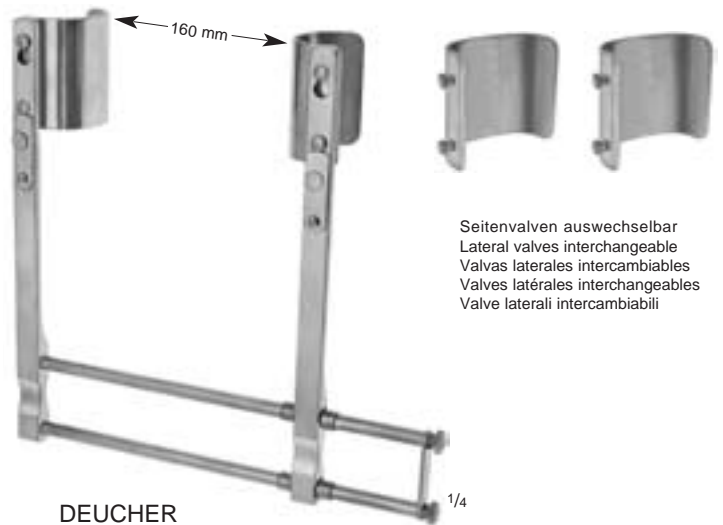

DEUCHER
21-0470

Bauchdeckenhalter, komplett, bestehend aus:
21-0471 1 Rahmen
21-0472 1 Paar Seitenventilen 52 x 60 mm (AxB)
21-0473 1 Paar Seitenventilen 64 x 60 mm (AxB)

Abdominal retractor, complete, consisting of:
21-0471 1 Frame
21-0472 1 Pair lateral valves 52 x 60 mm (AxB)
21-0473 1 Pair lateral valves 64 x 60 mm (AxB)

Separador abdominal, completo, compuesto de:
21-0471 1 Cuadro
21-0472 1 Par de valvas laterales 52 x 60 mm (AxB)
21-0473 1 Par de valvas laterales 64 x 60 mm (AxB)

Ecarteur abdominal, complet, composé de:
21-0471 1 Cadre
21-0472 1 Paire de valves latérales 52 x 60 mm (AxB)
21-0473 1 Paire de valves latérales 64 x 60 mm (AxB)

Divaricatore addominale, completo, composto da:
21-0471 1 Telaio
21-0472 1 Paio di valve laterali 52 x 60 mm (AxB)
21-0473 1 Paio di valve laterali 64 x 60 mm (AxB)

Seitenventilen auswechselbar
Lateral valves interchangeable
Valvas laterales intercambiables
Valves latérales interchangeables
Valve laterali intercambiabili

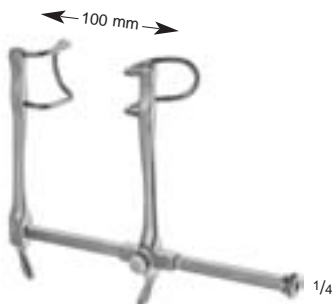

GOSSET-BABY
21-0420

Bauchdeckenhalter, Seitenventilen 38 x 23 mm (AxB)
und 38 x 31 mm (AxB)

Abdominal retractor, lateral valves 38 x 23 mm (AxB)
and 38 x 31 mm (AxB)

Separador abdominal, valvas laterales 38 x 23 mm (AxB)
y 38 x 31 mm (AxB)

Ecarteur abdominal, valves latérales 38 x 23 mm (AxB)
et 38 x 31 mm (AxB)

Divaricatore addominale, valve laterali 38 x 23 mm (AxB)
e 38 x 31 mm (AxB)



GOSSET
21-0425

Bauchdeckenhalter, Seitenventilen 63 x 29 mm (AxB)
und 63 x 36 mm (AxB)

Abdominal retractor, lateral valves 63 x 29 mm (AxB)
and 63 x 36 mm (AxB)

Separador abdominal, valvas laterales 63 x 29 mm (AxB)
y 63 x 36 mm (AxB)

Ecarteur abdominal, valves latérales 63 x 29 mm (AxB)
et 63 x 36 mm (AxB)

Divaricatore addominale, valve laterali 63 x 29 mm (AxB)
e 63 x 36 mm (AxB)



Bauchdeckenhalter
Abdominal Retractors
Separadores abdominales
Ecarteurs abdominaux
Divaricatori addominali

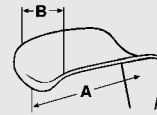

GOSSET
21-0426

Bauchdeckenhalter, Seitenvalven 63 x 29 mm (AxB) und 63 x 36 mm (AxB), mit Mittelvalve 59 x 57 mm (21-0429)

Abdominal retractor, lateral valves 63 x 29 mm (AxB) and 63 x 36 mm (AxB), with central valve 59 x 57 mm (21-0429)

Separador abdominal, valvas laterales 63 x 29 mm (AxB) y 63 x 36 mm (AxB), con valva central 59 x 57 mm (21-0429)

Ecarteur abdominal, valves latérales 63 x 29 mm (AxB) et 63 x 36 mm (AxB), avec valve centrale 59 x 57 mm (21-0429)

Divaricatore addominale, valve laterali 63 x 29 mm (AxB) e 63 x 36 mm (AxB), con valva centrale 59 x 57 mm (21-0429)



BALFOUR-BABY
21-0427

Bauchdeckenhalter, Seitenvalven 27 x 23 mm (AxB) und 27 x 28 mm (AxB), mit Mittelvalve 22 x 24 mm (21-0428)

Abdominal retractor, lateral valves 27 x 23 mm (AxB) and 27 x 28 mm (AxB), with central valve 22 x 24 mm (21-0428)

Separador abdominal, valvas laterales 27 x 23 mm (AxB) y 27 x 28 mm (AxB), con valva central 22 x 24 mm (21-0428)

Ecarteur abdominal, valves latérales 27 x 23 mm (AxB) et 27 x 28 mm (AxB), avec valve centrale 22 x 24 mm (21-0428)

Divaricatore addominale, valve laterali 27 x 23 mm (AxB) e 27 x 28 mm (AxB), con valva centrale 22 x 24 mm (21-0428)



BALFOUR
21-0500

Bauchdeckenhalter, Seitenvalven 48 x 28 mm (AxB) und 48 x 39 mm (AxB), mit Mittelvalve 48 x 78 mm (21-0507)

Abdominal retractor, lateral valves 48 x 28 mm (AxB) and 48 x 39 mm (AxB), with central valve 48 x 78 mm (21-0507)

Separador abdominal, valvas laterales 48 x 28 mm (AxB) y 48 x 39 mm (AxB), con valva central 48 x 78 mm (21-0507)

Ecarteur abdominal, valves latérales 48 x 28 mm (AxB) et 48 x 39 mm (AxB), avec valve centrale 48 x 78 mm (21-0507)

Divaricatore addominale, valve laterali 48 x 28 mm (AxB) e 48 x 39 mm (AxB), con valva centrale 48 x 78 mm (21-0507)



BALFOUR
21-0501

Bauchdeckenhalter, Seitenvalven 60 x 32 mm (AxB) und 60 x 38 mm (AxB), mit Mittelvalve 48 x 78 mm (21-0507)

Abdominal retractor, lateral valves 60 x 32 mm (AxB) and 60 x 38 mm (AxB), with central valve 48 x 78 mm (21-0507)

Separador abdominal, valvas laterales 60 x 32 mm (AxB) y 60 x 38 mm (AxB), con valva central 48 x 78 mm (21-0507)

Ecarteur abdominal, valves latérales 60 x 32 mm (AxB) et 60 x 38 mm (AxB), avec valve centrale 48 x 78 mm (21-0507)

Divaricatore addominale, valve laterali 60 x 32 mm (AxB) e 60 x 38 mm (AxB), con valva centrale 48 x 78 mm (21-0507)

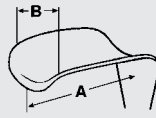

BALFOUR
 21-0502

Bauchdeckenhalter, Seitenvalven 100 x 32 mm (AxB) und 100 x 38 mm (AxB), mit Mittelvalve 80 x 80 mm (21-0509)
 Abdominal retractor, lateral valves 100 x 32 mm (AxB) and 100 x 38 mm (AxB), with central valve 80 x 80 mm (21-0509)
 Separador abdominal, valvas laterales 100 x 32 mm (AxB) y 100 x 38 mm (AxB), con valva central 80 x 80 mm (21-0509)
 Ecarteur abdominal, valves latérales 100 x 32 mm (AxB) et 100 x 38 mm (AxB), avec valve centrale 80 x 80 mm (21-0509)
 Divaricatore addominale, valve laterali 100 x 32 mm (AxB) e 100 x 38 mm (AxB), con valva centrale 80 x 80 mm (21-0509)



BALFOUR
 21-0505

Bauchdeckenhalter, Seitenvalven 60 x 36 mm (AxB), mit Mittelvalve 48 x 78 mm (21-0507)
 Abdominal retractor, lateral valves 60 x 36 mm (AxB), with central valve 48 x 78 mm (21-0507)
 Separador abdominal, valvas laterales 60 x 36 mm (AxB), con valva central 48 x 78 mm (21-0507)
 Ecarteur abdominal, valves latérales 60 x 36 mm (AxB), avec valve centrale 48 x 78 mm (21-0507)
 Divaricatore addominale, valve laterali 60 x 36 mm (AxB), con valva centrale 48 x 78 mm (21-0507)



BALFOUR
 21-0503

Bauchdeckenhalter, Seitenvalven 60 x 36 mm (AxB), mit Mittelvalve 48 x 78 mm (21-0507)
 Abdominal retractor, lateral valves 60 x 36 mm (AxB), with central valve 48 x 78 mm (21-0507)
 Separador abdominal, valvas laterales 60 x 36 mm (AxB), con valva central 48 x 78 mm (21-0507)
 Ecarteur abdominal, valves latérales 60 x 36 mm (AxB), avec valve centrale 48 x 78 mm (21-0507)
 Divaricatore addominale, valve laterali 60 x 36 mm (AxB), con valva centrale 48 x 78 mm (21-0507)



BALFOUR
 21-0510

Bauchdeckenhalter, Seitenvalven 100 x 32 mm (AxB) und 100 x 38 mm (AxB), mit Mittelvalve 100 x 64 mm (21-0512)
 Abdominal retractor, lateral valves 100 x 32 mm (AxB) and 100 x 38 mm (AxB), with central valve 100 x 64 mm (21-0512)
 Separador abdominal, valvas laterales 100 x 32 mm (AxB) y 100 x 38 mm (AxB), con valva central 100 x 64 mm (21-0512)
 Ecarteur abdominal, valves latérales 100 x 32 mm (AxB) et 100 x 38 mm (AxB), avec valve centrale 100 x 64 mm (21-0512)
 Divaricatore addominale, valve laterali 100 x 32 mm (AxB) e 100 x 38 mm (AxB), con valva centrale 100 x 64 mm (21-0512)



Bauchdeckenhalter
Abdominal Retractors
Separadores abdominales
Ecarteurs abdominaux
Divaricatori addominali

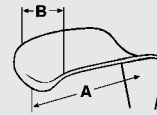

mit Sperre
with ratchet
con cremallera
avec crémaillère
con cremagliera

1/4

BALFOUR modif.
21-0430

Bauchdeckenhalter, Seitenvalven 64 x 45 mm (AxB), mit Mittelvalve 70 x 66 mm (21-0444)

Abdominal retractor, lateral valves 64 x 45 mm (AxB), with central valve 70 x 66 mm (21-0444)

Separador abdominal, valvas laterales 64 x 45 mm (AxB), con valva central 70 x 66 mm (21-0444)

Ecarteur abdominal, valves latérales 64 x 45 mm (AxB), avec valve centrale 70 x 66 mm (21-0444)

Divaricatore addominale, valve laterali 64 x 45 mm (AxB), con valva centrale 70 x 66 mm (21-0444)



mit Sperre
with ratchet
con cremallera
avec crémaillère
con cremagliera

1/4



Seitenvalven auswechselbar
Lateral valves interchangeable
Valvas laterales intercambiables
Valves latérales interchangeables
Valve laterali intercambiabili

BALFOUR modif.
21-0431

Bauchdeckenhalter, komplett, bestehend aus:
21-0432 1 Rahmen
21-0441 1 Paar Seitenvalven 64 x 45 mm (AxB)
21-0442 1 Paar Seitenvalven 89 x 45 mm (AxB)
21-0444 1 Mittelvalve 70 x 66 mm (AxB)

Abdominal retractor, complete, consisting of:
21-0432 1 Frame
21-0441 1 Pair lateral valves 64 x 45 mm (AxB)
21-0442 1 Pair lateral valves 89 x 45 mm (AxB)
21-0444 1 Central valve 70 x 66 mm (AxB)

Separador abdominal, completo, compuesto de:
21-0432 1 Cuadro
21-0441 1 Par de valvas laterales 64 x 45 mm (AxB)
21-0442 1 Par de valvas laterales 89 x 45 mm (AxB)
21-0444 1 Valva central 70 x 66 mm (AxB)

Ecarteur abdominal, complet, composé de:
21-0432 1 Cadre
21-0441 1 Paire de valves latérales 64 x 45 mm (AxB)
21-0442 1 Paire de valves latérales 89 x 45 mm (AxB)
21-0444 1 Valve centrale 70 x 66 mm (AxB)

Divaricatore addominale, completo, composto da:
21-0432 1 Telaio
21-0441 1 Paio di valve laterali 64 x 45 mm (AxB)
21-0442 1 Paio di valve laterali 89 x 45 mm (AxB)
21-0444 1 Valva centrale 70 x 66 mm (AxB)

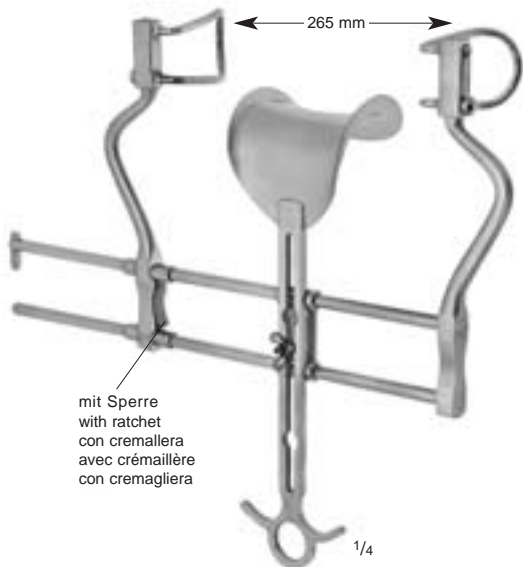

mit Sperre
with ratchet
con cremallera
avec crémaillère
con cremagliera

1/4



Seitenvalven auswechselbar
Lateral valves interchangeable
Valvas laterales intercambiables
Valves latérales interchangeables
Valve laterali intercambiabili

BALFOUR modif.
21-0435

Bauchdeckenhalter, komplett, bestehend aus:
21-0436 1 Rahmen
21-0441 1 Paar Seitenvalven 64 x 45 mm (AxB)
21-0442 1 Paar Seitenvalven 89 x 45 mm (AxB)
21-0445 1 Mittelvalve 65 x 84 mm (AxB)

Abdominal retractor, complete, consisting of:
21-0436 1 Frame
21-0441 1 Pair lateral valves 64 x 45 mm (AxB)
21-0442 1 Pair lateral valves 89 x 45 mm (AxB)
21-0445 1 Central valve 65 x 84 mm (AxB)

Separador abdominal, completo, compuesto de:
21-0436 1 Cuadro
21-0441 1 Par de valvas laterales 64 x 45 mm (AxB)
21-0442 1 Par de valvas laterales 89 x 45 mm (AxB)
21-0445 1 Valva central 65 x 84 mm (AxB)

Ecarteur abdominal, complet, composé de:
21-0436 1 Cadre
21-0441 1 Paire de valves latérales 64 x 45 mm (AxB)
21-0442 1 Paire de valves latérales 89 x 45 mm (AxB)
21-0445 1 Valve centrale 65 x 84 mm (AxB)

Divaricatore addominale, completo, composto da:
21-0436 1 Telaio
21-0441 1 Paio di valve laterali 64 x 45 mm (AxB)
21-0442 1 Paio di valve laterali 89 x 45 mm (AxB)
21-0445 1 Valva centrale 65 x 84 mm (AxB)

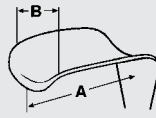

BALFOUR

- 21-0441 64 x 45 mm (AxB)
- 21-0442 89 x 45 mm (AxB)
- ▶ 21-0443 103 x 45 mm (AxB)

Seitenvalven, 1 Paar, für Bauchdeckenhalter
 21-0430 / 21-0431 / 21-0435

Lateral valves, 1 pair, for abdominal retractors
 21-0430 / 21-0431 / 21-0435

Valvas laterales, 1 par, para separadores
 abdominales 21-0430 / 21-0431 / 21-0435

Valves latérales, 1 paire, pour écarteurs
 abdominaux 21-0430 / 21-0431 / 21-0435

Valve laterali, 1 paio, per divaricatori addominali
 21-0430 / 21-0431 / 21-0435



BALFOUR

- 21-0444 70 x 66 mm (AxB)
- 21-0445 65 x 84 mm (AxB)
- ▶ 21-0446 45 x 93 mm (AxB)

Mittelvalven für Bauchdeckenhalter
 21-0430 / 21-0431 / 21-0435

Central valves, for abdominal retractors
 21-0430 / 21-0431 / 21-0435

Valvas centrales, para separadores
 abdominales 21-0430 / 21-0431 / 21-0435

Valves centrales, pour écarteurs
 abdominaux 21-0430 / 21-0431 / 21-0435

Valve centrali, per divaricatori addominali
 21-0430 / 21-0431 / 21-0435



HORGAN

- 21-0447
- 183 x 51 mm (AxB)

Mittelvalve, biegsam, für Bauchdeckenhalter
 21-0430 / 21-0431 / 21-0435

Central valve, malleable, for abdominal
 retractors 21-0430 / 21-0431 / 21-0435

Valva central, maleable, para separadores
 abdominales 21-0430 / 21-0431 / 21-0435

Valve centrale, malléable, pour écarteurs
 abdominaux 21-0430 / 21-0431 / 21-0435

Valva centrale, malleabile, per divaricatori
 addominali 21-0430 / 21-0431 / 21-0435



BALFOUR

- ▶ 21-0448 rechts • right • derecho • à droite • destra
- 21-0449 links • left • izquierdo • à gauche • sinistra

Seitenarme für Bauchdeckenhalter 21-0430 / 21-0431 / 21-0435

Side-arms for abdominal retractors 21-0430 / 21-0431 / 21-0435

Brazos laterales para separadores abdominales 21-0430 / 21-0431 / 21-0435

Bras latéraux pour écarteurs abdominaux 21-0430 / 21-0431 / 21-0435

Braccio laterale per divaricatori addominali 21-0430 / 21-0431 / 21-0435



Bauchdeckenhalter
Abdominal Retractors
Separadores abdominales
Ecarteurs abdominaux
Divaricatori addominali

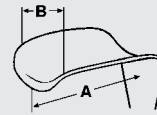

O'SULLIVAN-O'CONNOR
21-0550

Bauchdeckenhalter, komplett, bestehend aus:
21-0554 1 Rahmen mit 2 Seitenvalven 62 x 25 mm (AxB)
21-0552 2 Valven 81 x 46 mm (AxB)
21-0553 1 Valve 110 x 72 mm (AxB)

Abdominal retractor, complete, consisting of:
21-0554 1 Frame with 2 lateral valves 62 x 25 mm (AxB)
21-0552 2 Valves 81 x 46 mm (AxB)
21-0553 1 Valve 110 x 72 mm (AxB)

Separador abdominal, completo, compuesto de:
21-0554 1 Cuadro con 2 valvas laterales 62 x 25 mm (AxB)
21-0552 2 Valvas 81 x 46 mm (AxB)
21-0553 1 Valva 110 x 72 mm (AxB)

Ecarteur abdominal, complet, composé de:
21-0554 1 Cadre avec 2 valves latérales 62 x 25 mm (AxB)
21-0552 2 Valves 81 x 46 mm (AxB)
21-0553 1 Valve 110 x 72 mm (AxB)

Divaricatore addominale, completo, composto da:
21-0554 1 Telaio con valve laterali 62 x 25 mm (AxB)
21-0552 2 Valve 81 x 46 mm (AxB)
21-0553 1 Valva 110 x 72 mm (AxB)

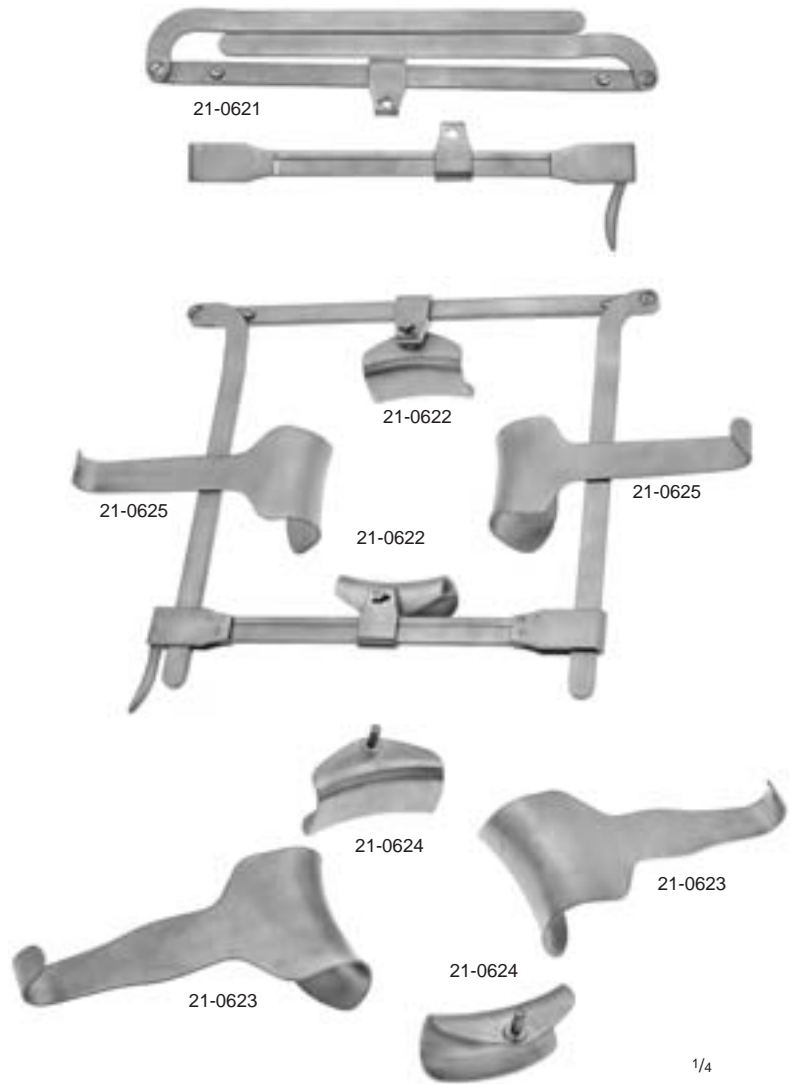

FRANZ
21-0620

Bauchdeckenhalter, komplett, bestehend aus:
21-0621 1 zusammenlegbarer Rahmen 220 x 220 mm
21-0622 2 Valven 40 x 62 mm (AxB)
21-0624 2 Valven 43 x 80 mm (AxB)
21-0625 2 Valven 48 x 65 mm (AxB)
21-0623 2 Valven 46 x 91 mm (AxB)

Abdominal retractor, complete, consisting of:
21-0621 1 Folding frame 220 x 220 mm
21-0622 2 Valves 40 x 62 mm (AxB)
21-0624 2 Valves 43 x 80 mm (AxB)
21-0625 2 Valves 48 x 65 mm (AxB)
21-0623 2 Valves 46 x 91 mm (AxB)

Separador abdominal, completo, compuesto de:
21-0621 1 Cuadro plegable 220 x 220 mm
21-0622 2 Valvas 40 x 62 mm (AxB)
21-0624 2 Valvas 43 x 80 mm (AxB)
21-0625 2 Valvas 48 x 65 mm (AxB)
21-0623 2 Valvas 46 x 91 mm (AxB)

Ecarteur abdominal, complet, composé de:
21-0621 1 Cadre pliant 220 x 220 mm
21-0622 2 Valves 40 x 62 mm (AxB)
21-0624 2 Valves 43 x 80 mm (AxB)
21-0625 2 Valves 48 x 65 mm (AxB)
21-0623 2 Valves 46 x 91 mm (AxB)

Divaricatore addominale, completo, composto da:
21-0621 1 Telaio piegabile 220 x 220 mm
21-0622 2 Valve 40 x 62 mm (AxB)
21-0624 2 Valve 43 x 80 mm (AxB)
21-0625 2 Valve 48 x 65 mm (AxB)

Bauchdeckenhalter
Abdominal Retractors
Separadores abdominales
Ecarteurs abdominaux
Divaricatori addominali

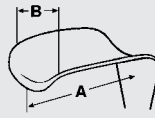

DENIS-BROWNE

21-0556

Bauchdeckenhalter, komplett, bestehend aus:
21-0557 1 Rahmen 180 x 150 mm
21-0558 2 Valven 40 x 30 mm (AxB)
21-0559 2 Valven 40 x 40 mm (AxB)

Abdominal retractor, complete, consisting of:
21-0557 1 Frame 180 x 150 mm
21-0558 2 Valves 40 x 30 mm (AxB)
21-0559 2 Valves 40 x 40 mm (AxB)

Separador abdominal, completo, compuesto de:
21-0557 1 Cuadro 180 x 150 mm
21-0558 2 Valvas 40 x 30 mm (AxB)
21-0559 2 Valvas 40 x 40 mm (AxB)

Ecarteur abdominal, complet, composé de:
21-0557 1 Cadre 180 x 150 mm
21-0558 2 Valves 40 x 30 mm (AxB)
21-0559 2 Valves 40 x 40 mm (AxB)

Divaricatore addominale, completo, composto da:
21-0557 1 Telaio 180 x 150 mm
21-0558 2 Valve 40 x 30 mm (AxB)
21-0559 2 Valve 40 x 40 mm (AxB)

21-0557 180 x 150 mm

21-0560 255 x 180 mm

Rahmen
Frames
Cuadros
Cadres
Telaio



für die Gynäkologie
for gynecology
para ginecología
pour gynécologie
per ginecologia

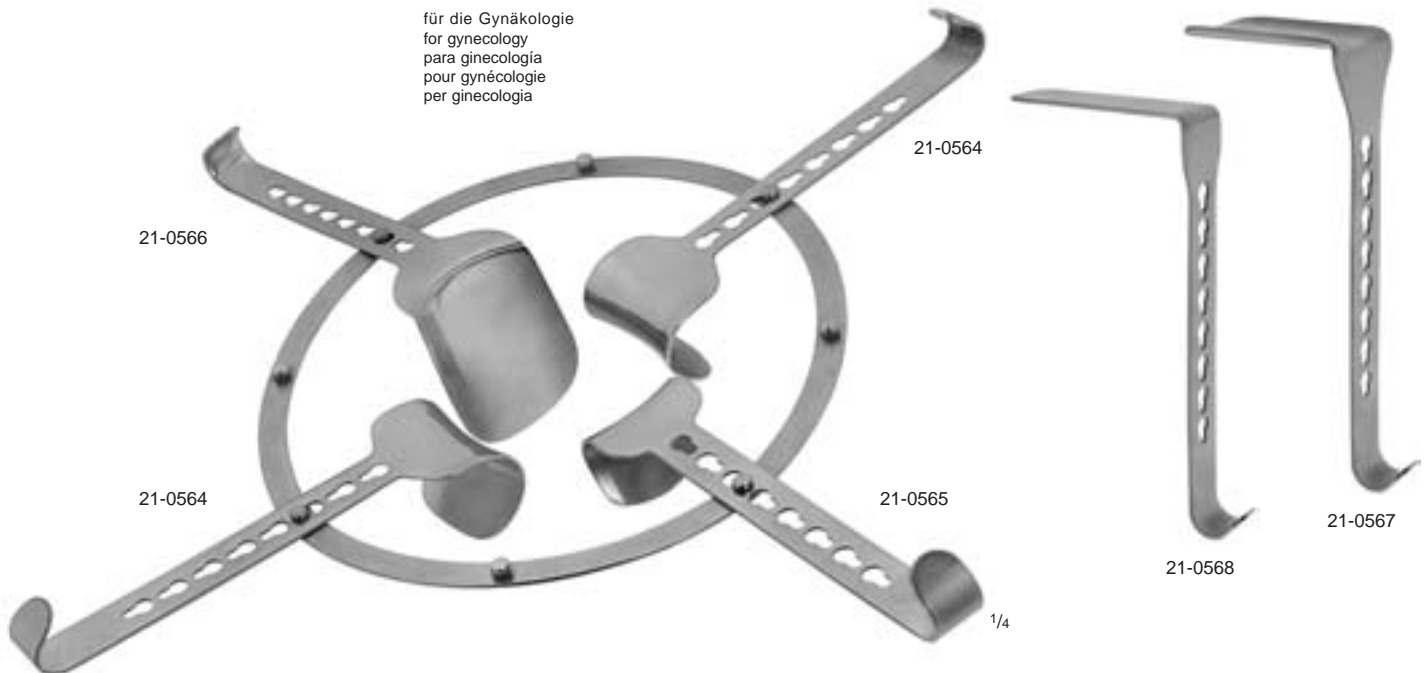

SEMM
21-0562

Bauchdeckenhalter, komplett, bestehend aus:
21-0563 1 Rahmen 275 x 250 mm
21-0564 2 Valven 47 x 65 mm (AxB)
21-0565 1 Valve für die Blase 50 x 54 mm (AxB)
21-0566 1 Valve für den Darm 76 x 98 mm (AxB)
21-0567 1 Valve für den Darm 98 x 52 mm (AxB)
21-0568 1 Valve 105 x 35 mm (AxB)

Ecarteur abdominal, complet, composé de:
21-0563 1 Cadre 275 x 250 mm
21-0564 2 Valves 47 x 65 mm (AxB)
21-0565 1 Valve pour vessie 50 x 54 mm (AxB)
21-0566 1 Valve pour intestin 76 x 98 mm (AxB)
21-0567 1 Valve pour intestin 98 x 52 mm (AxB)
21-0568 1 Valve 105 x 35 mm (AxB)

Abdominal retractor, complete, consisting of:
21-0563 1 Frame 275 x 250 mm
21-0564 2 Valves 47 x 65 mm (AxB)
21-0565 1 Valve for bladder 50 x 54 mm (AxB)
21-0566 1 Valve for intestine 76 x 98 mm (AxB)
21-0567 1 Valve for intestine 98 x 52 mm (AxB)
21-0568 1 Valve 105 x 35 mm (AxB)

Divaricatore addominale, completo, composto da:
21-0563 1 Telaio 275 x 250 mm
21-0564 2 Valve 47 x 65 mm (AxB)
21-0565 1 Valva per vescica 50 x 54 mm (AxB)
21-0566 1 Valva per intestino 76 x 98 mm (AxB)
21-0567 1 Valva per intestino 98 x 52 mm (AxB)
21-0568 1 Valva 105 x 35 mm (AxB)

Separador abdominal, completo, compuesto de:
21-0563 1 Cuadro 275 x 250 mm
21-0564 2 Valvas 47 x 65 mm (AxB)
21-0565 1 Valva para vejiga 50 x 54 mm (AxB)
21-0566 1 Valva para intestino 76 x 98 mm (AxB)
21-0567 1 Valva para intestino 98 x 52 mm (AxB)
21-0568 1 Valva 105 x 35 mm (AxB)



Bauchdeckenhalter
Abdominal Retractors
Separadores abdominales
Ecarteurs abdominaux
Divaricatori addominali

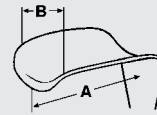

KIRSCHNER

► 21-0570

Bauchdeckenhalter, komplett, bestehend aus:
21-0575 1 starrer Rahmen 250 x 250 mm
21-0571 2 Valven 43 x 55 mm (AxB)
21-0572 2 Valven 48 x 65 mm (AxB)

Abdominal retractor, complete, consisting of:
21-0575 1 Fixed frame 250 x 250 mm
21-0571 2 Valves 43 x 55 mm (AxB)
21-0572 2 Valves 48 x 65 mm (AxB)

Separador abdominal, completo, compuesto de:
21-0575 1 Cuadro fijo 250 x 250 mm
21-0571 2 Valvas 43 x 55 mm (AxB)
21-0572 2 Valvas 48 x 65 mm (AxB)

Ecarteur abdominal, complet, composé de:
21-0575 1 Cadre fixe 250 x 250 mm
21-0571 2 Valves 43 x 55 mm (AxB)
21-0572 2 Valves 48 x 65 mm (AxB)

Divaricatore addominale, completo, composto da:
21-0575 1 Telaio fisso 250 x 250 mm
21-0571 2 Valve 43 x 55 mm (AxB)
21-0572 2 Valve 48 x 65 mm (AxB)

21-0575 250 x 250 mm
21-0584 300 x 320 mm
21-0585 300 x 380 mm

Starre Rahmen
Fixed frames
Cuadros fijos
Cadres fixe
Telaio fisso

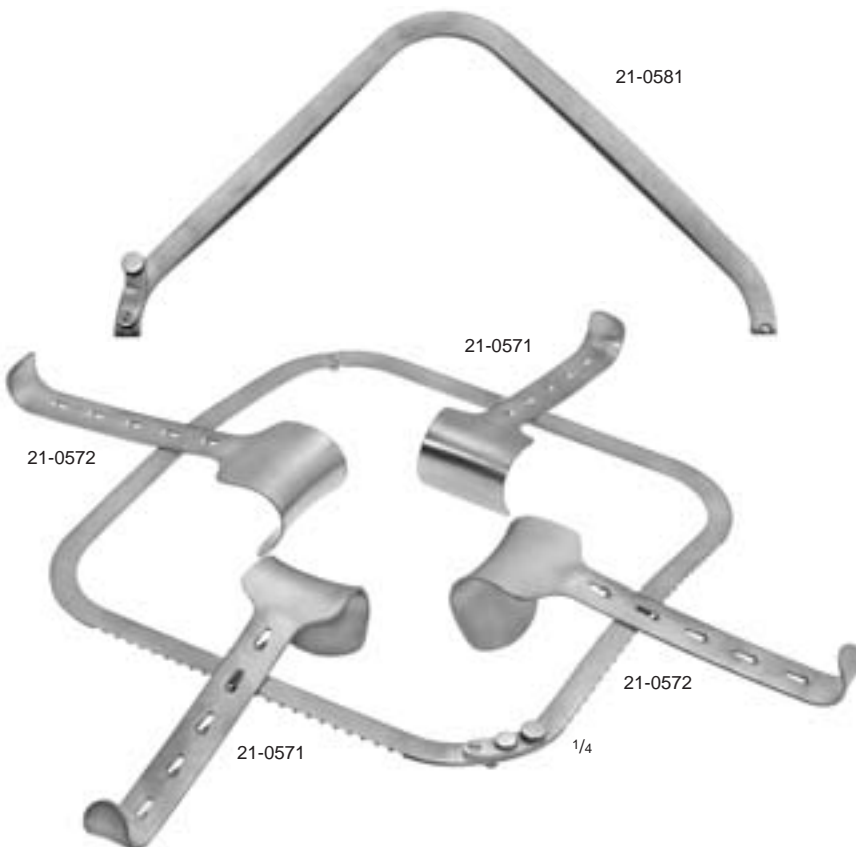
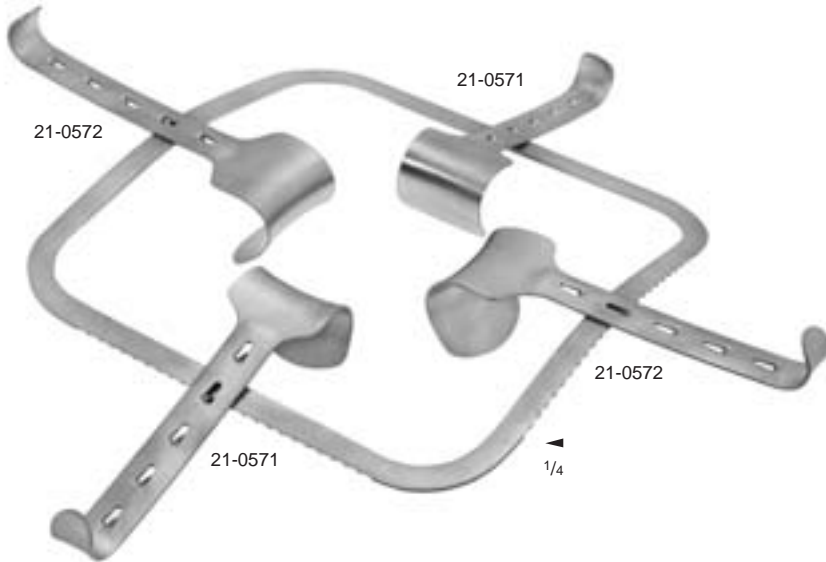

KIRSCHNER

21-0579

Bauchdeckenhalter, komplett, bestehend aus:
21-0581 1 zusammenlegbarer Rahmen 255 x 255 mm
21-0571 2 Valven 43 x 55 mm (AxB)
21-0572 2 Valven 48 x 65 mm (AxB)

Abdominal retractor, complete, consisting of:
21-0581 1 Folding frame 255 x 255 mm
21-0571 2 Valves 43 x 55 mm (AxB)
21-0572 2 Valves 48 x 65 mm (AxB)

Separador abdominal, completo, compuesto de:
21-0581 1 Cuadro plegable 255 x 255 mm
21-0571 2 Valvas 43 x 55 mm (AxB)
21-0572 2 Valvas 48 x 65 mm (AxB)

Ecarteur abdominal, complet, composé de:
21-0581 1 Cadre pliant 255 x 255 mm
21-0571 2 Valves 43 x 55 mm (AxB)
21-0572 2 Valves 48 x 65 mm (AxB)

Divaricatore addominale, completo, composto da:
21-0581 1 Telaio pieghevole 255 x 255 mm
21-0571 2 Valve 43 x 55 mm (AxB)
21-0572 2 Valve 48 x 65 mm (AxB)

Valven für KIRSCHNER Bauchdeckenhalter
 Valves for KIRSCHNER Abdominal Retractors
 Valvas para separadores abdominales KIRSCHNER
 Valves pour écarteurs abdominaux KIRSCHNER
 Valve per divaricatori addominali KIRSCHNER

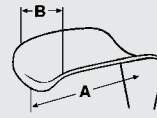

KIRSCHNER
 21-0571 43 x 55 mm (AxB)
 ► 21-0572 48 x 65 mm (AxB)
 21-0578 80 x 90 mm (AxB)
 21-0573 90 x 65 mm (AxB)
 21-0574 98 x 95 mm (AxB)



KIRSCHNER-BALFOUR
 21-0577
 83 x 82 mm (AxB)



KIRSCHNER
 21-0576
 60 x 82 mm (AxB)



KIRSCHNER
 21-0587 98 x 51 mm (AxB)
 ► 21-0588 105 x 38 mm (AxB)



Bauchdeckenhalter
Abdominal Retractors
Separadores abdominales
Ecarteurs abdominaux
Divaricatori addominali

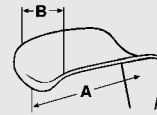

1/4

FOERSTER 21-0650

Bauchdeckenhalter aus NYLON, röntgendurchlässig, sterilisierbar nur im Autoklav bei 2 bar Überdruck (134°C), komplett, bestehend aus:
21-0651 1 Rahmen 255 x 255 mm
21-0652 4 Valven 51 x 64 mm (AxB)

Abdominal retractor, made of NYLON, transparent to X-ray, sterilizable only in the autoclave at 2 bar overpressure (134°C), complete, consisting of:

21-0651 1 Frame 255 x 255 mm
21-0652 4 Valves 51 x 64 mm (AxB)

Separador abdominal, de NILON, transparente a los rayos-x, esterilizable solamente en autoclave a 2 bar sobrepresión (134°C), completo, compuesto de:

21-0651 1 Cuadro 255 x 255 mm
21-0652 4 Valvas 51 x 64 mm (AxB)

Ecarteur abdominal, en VINYL, transparent aux rayons X stérilisable en autoclave à 2 bar (134°C) seulement, complet, composé de:

21-0651 1 Cadre 255 x 255 mm
21-0652 4 Valves 51 x 64 mm (AxB)

Divaricatore addominale, in NYLON, radiotrasparente, sterilizzabile solo in autoclave a 2 bar (134°C), completo, composta da:

21-0651 1 Telaio 255 x 255 mm
21-0652 4 Valve 51 x 64 mm (AxB)



1/4

FOERSTER 21-0652 51 x 64 mm (AxB)

Valve aus NYLON, für Bauchdeckenhalter 21-0650

Valve, made of NYLON, for abdominal retractor 21-0650

Valva, de NILON, para separador abdominal 21-0650

Valve VINYL, pour écarteur abdominal 21-0650

Valva, in NYLON, per divaricatore addominale 21-0650



1/4

FOERSTER 21-0653 78 x 65 mm (AxB)

Valve aus NYLON, für Bauchdeckenhalter 21-0650

Valve, made of NYLON, for abdominal retractor 21-0650

Valva, de NILON, para separador abdominal 21-0650

Valve VINYL, pour écarteur abdominal 21-0650

Valva, in NYLON, per divaricatore addominale 21-0650



1/2

FOERSTER 21-0654

Ersatzknopf aus NYLON, für Rahmen 21-0651

Spare button, made of NYLON, for frame 21-0651

Botón de repuesto, de NILON, para cuadro 21-0651

Bouton VINYL, pour cadre 21-0651

Bottone di ricambio, in NYLON, per telaio 21-0651

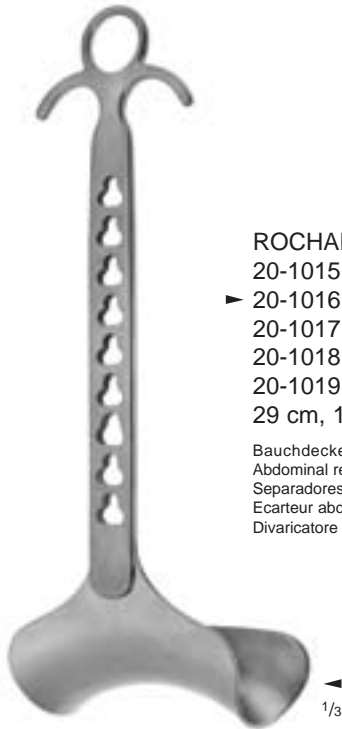
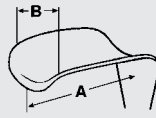

ROCHARD
 20-1015 50 x 90 mm (AxB)
 ▶ 20-1016 50 x 105 mm (AxB)
 20-1017 50 x 120 mm (AxB)
 20-1018 50 x 135 mm (AxB)
 20-1019 50 x 155 mm (AxB)
 29 cm, 11 1/2"
 Bauchdeckenhaken
 Abdominal retractors
 Separadores abdominales
 Ecarteur abdominal
 Divaricatore addominale



ROCHARD
 20-1011
 19,5 cm, 7 3/4"

Fixiervorrichtung für 20-1015 - 20-1019
 Fixation device for 20-1015 - 20-1019
 Dispositivo de fijación para 20-1015 - 20-1019
 Compas articulé pour 20-1015 - 20-1019
 Dispositivo di fissaggio per 20-1015 - 20-1019



ROCHARD
 20-1010

Befestigungsgestell zur Fixierung an den Seitenschiene
 25 x 10 mm der OP-Tische, zur Sterilisation zerlegbar
 Mounting frame for fastening to the lateral bars 25 x 10 mm
 of the operating tables, can be dismantled for sterilization
 Bastidor para la fijación a las barras laterales 25 x 10 mm
 de las mesas de operación, plegable para la esterilización
 Cadre se fixant aux barres latérales 25 x 10 mm de la table
 d'opération, pliable pour stérilisation
 Telaio di supporto per il fissaggio alla barra laterale 25 x 10 mm
 del tavolo operatorio può essere smontato per la sterilizzazione

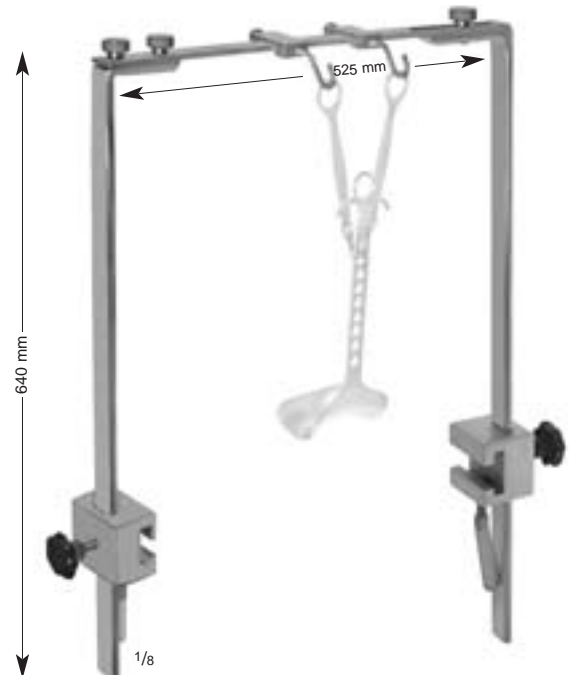

ROCHARD
 20-1013

Befestigungsgestell mit beidseitiger Fixierung an den Seitenschiene
 25 x 10 mm der OP-Tische, zur Sterilisation zerlegbar
 Mounting frame for fastening to both sides of the lateral bars 25 x 10 mm
 of the operating table, can be dismantled for sterilization
 Bastidor para la fijación a las ambas barras laterales 25 x 10 mm
 de las mesas de operación, plegable para la esterilización
 Cadre se fixant aux barres latérales 25 x 10 mm de chaque côté de la
 table d'opération, pliable pour stérilisation
 Telaio di supporto per il fissaggio alla barra laterali 25 x 10 mm del
 tavolo operatorio può essere smontato per la sterilizzazione



Blasenwundspreizer
Bladder Retractors
Separadores para la vejiga
Ecarteurs vésicaux
Divaricatori vescicali

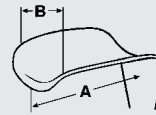

MILLIN
92-0130
21,5 cm, 8 1/2"

Blasenwundspreizer, komplett, bestehend aus:
92-0136 1 Spreizer
92-0137 1 Paar Seitenvalven 57 x 25 mm (AxB)
92-0138 1 Paar Seitenvalven 80 x 25 mm (AxB)
92-0139 1 Mittelvalve 120 x 45 mm (AxB)

Bladder retractor, complete, consisting of:
92-0136 1 Spreader
92-0137 1 Pair lateral valves 57 x 25 mm (AxB)
92-0138 1 Pair lateral valves 80 x 25 mm (AxB)
92-0139 1 Central valve 120 x 45 mm (AxB)

Separador para la vejiga, completo, compuesto de:
92-0136 1 Separador
92-0137 1 Par de valvas laterales 57 x 25 mm (AxB)
92-0138 1 Par de valvas laterales 80 x 25 mm (AxB)
92-0139 1 Valva central 120 x 45 mm (AxB)

Ecarteur vésical, complet, composé de:
92-0136 1 Ecarteur
92-0137 1 Paire de valves latérales 57 x 25 mm (AxB)
92-0138 1 Paire de valves latérales 80 x 25 mm (AxB)
92-0139 1 Valve centrale 120 x 45 mm (AxB)

Divaricatore vescicale, completo, composto da:
92-0136 1 Divaricatore
92-0137 1 Paio di valve laterali 57 x 25 mm (AxB)
92-0138 1 Paio di valve laterali 80 x 25 mm (AxB)
92-0139 1 Valva centrale 120 x 45 mm (AxB)



**JUDD-
MASSON**
92-0105

Blasenwundspreizer für suprapubische Prostatektomie, komplett, bestehend aus:
92-0106 1 Rahmen mit 2 Seitenvalven 70 x 25 mm (AxB)
92-0104 1 Mittelvalve 84 x 24 mm (AxB)

Bladder and suprapubic retractor, complete, consisting of:
92-0106 1 Frame with 2 lateral valves 70 x 25 mm (AxB)
92-0104 1 Central valve 84 x 24 mm (AxB)

Separador para la vejiga y la prostatectomía suprapubica, completo, compuesto de:
92-0106 1 Cuadro con 2 valvas laterales 70 x 25 mm (AxB)
92-0104 1 Valva central 84 x 24 mm (AxB)

Ecarteur pour la vessie et prostatectomie, complet, composé de:
92-0106 1 Cadre avec 2 valves latérales 70 x 25 mm (AxB)
92-0104 1 Valve centrale 84 x 24 mm (AxB)

Divaricatore per la vescica e la prostatectomia sovrapubica, completo, composta da:
92-0106 1 Telaio con 2 valve laterali 70 x 25 mm (AxB)
92-0104 1 Valva centrale 84 x 24 mm (AxB)

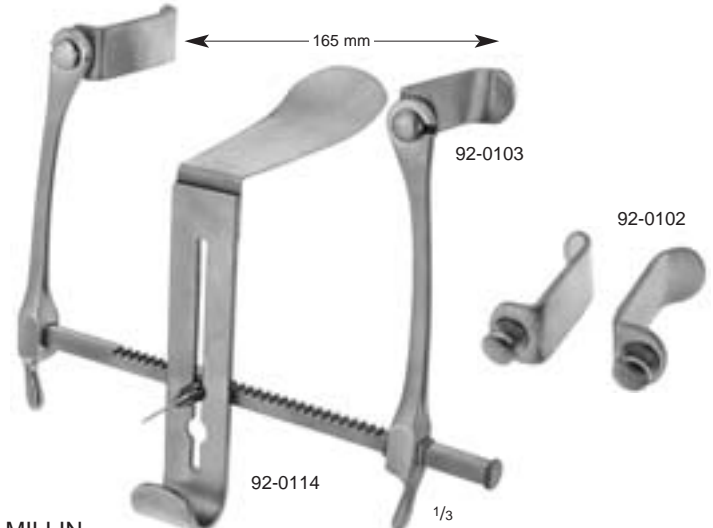

MILLIN
92-0108

Blasenwundspreizer, komplett, bestehend aus:
92-0101 1 Rahmen
92-0102 1 Paar Seitenvalven 50 x 22 mm (AxB)
92-0103 1 Paar Seitenvalven 63 x 22 mm (AxB)
92-0114 1 Mittelvalve 120 x 52 mm (AxB)

Bladder retractor, complete, consisting of:
92-0101 1 Frame
92-0102 1 Pair lateral valves 50 x 22 mm (AxB)
92-0103 1 Pair lateral valves 63 x 22 mm (AxB)
92-0114 1 Central valve 120 x 52 mm (AxB)

Separador para la vejiga, completo, compuesto de:
92-0101 1 Cuadro
92-0102 1 Par de valvas laterales 50 x 22 mm (AxB)
92-0103 1 Par de valvas laterales 63 x 22 mm (AxB)
92-0114 1 Valva central 120 x 52 mm (AxB)

Ecarteur vésical, complet, composé de:
92-0101 1 Cadre
92-0102 1 Paire de valves latérales 50 x 22 mm (AxB)
92-0103 1 Paire de valves latérales 63 x 22 mm (AxB)
92-0114 1 Valve centrale 120 x 52 mm (AxB)

Divaricatore per la vescica, completo, composto da:
92-0101 1 Telaio
92-0102 1 Paio di valve laterali 50 x 22 mm (AxB)
92-0103 1 Paio di valve laterali 63 x 22 mm (AxB)
92-0114 1 Valva centrale 120 x 52 mm (AxB)

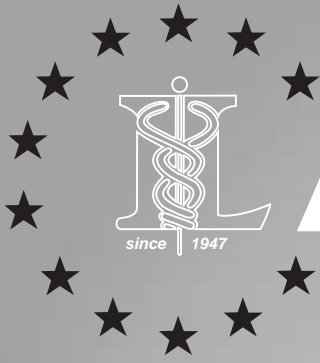

LAWNTON

Medizintechnik



Sonden, Trokare, Saugrohre, Spritzen
Probes, Trocars, Suction Tubes, Syringes
Sondas, Trócares, Tubos de aspiración, Jeringas
Sondes, Trocarts, Canules d'aspiration, Seringues
Sonde, Trequarti, Tubi aspirazione, Siringhe

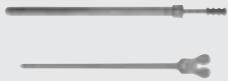

Sonden
Probes
Sondas
Stylets
Sonde



13 cm, 5 1/8"

| Fig. | ø mm | Silber Silver Plata Argent Argento | Neusilber German silver Plata meneses Argent blanc Argento bianco |
|----------|-----------|--|---|
| 0000/000 | 0,4 / 0,6 | 63-2200 | 63-2230 |
| 00/0 | 0,7 / 0,8 | 63-2201 | 63-2231 |
| 1/2 | 0,9 / 1,1 | 63-2202 | 63-2233 |
| 3/4 | 1,3 / 1,4 | ▶ 63-2203 | 63-2235 |
| 5/6 | 1,5 / 1,6 | 63-2204 | 63-2237 |
| 7/8 | 1,8 / 1,9 | 63-2205 | 63-2239 |

Tränenkanalsonden, zylindrisch / zylindrisch
Lachrymal probes, cylindrical / cylindrical
Estiletes para el canal lacrimal, cilíndricos / cilíndricos
Stylets pour le canal lacrymal, cylindriques / cylindriques
Stiletti per canale lacrimale, cilindrici / cilindrici



13 cm, 5 1/8"

| Fig. | ø mm | Silber Silver Plata Argent Argento | Neusilber German silver Plata meneses Argent blanc Argento bianco |
|----------|-----------|--|---|
| 0000/000 | 0,4 / 0,6 | 63-2225 | 63-2240 |
| 00/0 | 0,7 / 0,8 | 63-2220 | 63-2241 |
| 1/2 | 0,9 / 1,1 | 63-2221 | 63-2243 |
| 3/4 | 1,3 / 1,4 | ▶ 63-2222 | 63-2245 |
| 5/6 | 1,5 / 1,6 | 63-2223 | 63-2247 |
| 7/8 | 1,8 / 1,9 | 63-2224 | 63-2249 |

Tränenkanalsonden, geknöpft / geknöpft
Lachrymal probes, buttoned / buttoned
Estiletes para el canal lacrimal, abotonados / abotonados
Stylets pour le canal lacrymal, boutonnés / boutonnés
Stiletti per canale lacrimale, bottonuti / bottonuti



- 15-0315 13,0 cm, 5 1/8"
- 15-0316 14,5 cm, 5 3/4"
- ▶ 15-0317 16,0 cm, 6 1/4"
- 15-0318 18,0 cm, 7"
- 15-0319 20,0 cm, 8"

Knopfsonden ø 1 mm
Buttoned probes, ø 1 mm
Sondas abotonadas, ø 1 mm
Sondes boutonnées, ø 1 mm
Sonde bottonute, ø 1 mm



- 15-0335 13,0 cm, 5 1/8"
- 15-0336 14,5 cm, 5 3/4"
- ▶ 15-0337 16,0 cm, 6 1/4"
- 15-0338 18,0 cm, 7"
- 15-0339 20,0 cm, 8"
- 15-0340 25,0 cm, 10"

Knopfsonden ø 1,5 mm
Buttoned probes, ø 1,5 mm
Sondas abotonadas, ø 1,5 mm
Sondes boutonnées, ø 1,5 mm
Sonde bottonute, ø 1,5 mm



- 15-0344 13,0 cm, 5 1/8"
- 15-0345 14,5 cm, 5 3/4"
- ▶ 15-0346 16,0 cm, 6 1/4"
- 15-0347 18,0 cm, 7"
- 15-0348 20,0 cm, 8"
- 15-0349 25,0 cm, 10"
- 15-0350 30,0 cm, 12"

Knopfsonden ø 2 mm
Buttoned probes, ø 2 mm
Sondas abotonadas, ø 2 mm
Sondes boutonnées, ø 2 mm
Sonde bottonute, ø 2 mm

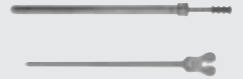

- 15-0304 13,0 cm, 5 1/8"
- ▶ 15-0305 14,5 cm, 5 3/4"
- 15-0306 16,0 cm, 6 1/4"
- 15-0307 18,0 cm, 7"
- 15-0308 20,0 cm, 8"
- 15-0310 25,0 cm, 10"

Öhrsonden ø 2 mm,
rostfrei

Probes with eye, ø 2 mm,
stainless steel

Sondas con ojete, ø 2 mm,
de acero inoxidable

Stylet aiguillé, ø 2 mm,
inoxydable

sonde con occhiello, ø 2 mm,
acciaio inox



- 15-0504 13,0 cm, 5 1/8"
- ▶ 15-0505 14,5 cm, 5 3/4"
- 15-0506 16,0 cm, 6 1/4"
- 15-0507 18,0 cm, 7"
- 15-0508 20,0 cm, 8"

Öhrsonden ø 2 mm,
Silber

Probes with eye, ø 2 mm,
silver

Sondas con ojete ø 2 mm,
de plata

Stylet aiguillé, ø 2 mm,
argent

sonde con occhiello ø 2 mm,
argento



- 15-0575 13,0 cm, 5 1/8"
- 15-0576 14,5 cm, 5 3/4"
- ▶ 15-0577 16,0 cm, 6 1/4"
- 15-0578 18,0 cm, 7"
- 15-0579 20,0 cm, 8"

Myrtenblattsonden
ø 2 mm

Myrtle leaf probes,
ø 2 mm

Sondas forma mirto,
ø 2 mm

Stylet feuille de sauge,
ø 2 mm

sonde a foglia di mirto,
ø 2 mm



STACKE

- 15-0560
11,5 cm, 4 1/2"

Knopfsonde ø 0,8 mm, Silber
Buttoned probe, ø 0.8 mm, silver
Sonda abotonada, ø 0,8 mm, plata
Sonde boutonée, ø 0,8 mm, argent
Sonda bottonuta, 0,8 mm, argento



FLUHRER

- ▶ 15-0555 ø 3,5 mm x 250 mm
- 15-0557 ø 3,5 mm x 400 mm

Knopfsonden, biegsam, Zinn
Buttoned probes, malleable, tin
Sondas abotonadas, maleable, estaño
Sondes boutonées, malléables, étain
Sonda bottonute, malleabili, stagno



- 15-0550 ø 1,5 mm x 300 mm
- ▶ 15-0551 ø 2,0 mm x 300 mm
- 15-0552 ø 2,5 mm x 300 mm

Knopfsonden
Buttoned probes
Sondas abotonadas
Sondes boutonée
Sonda bottonute

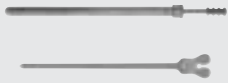

Sonden
Probes
Sondas
Sondes
Sonde



1/2

15-0203 11,5 cm, 4 1/2"
15-0204 13,0 cm, 5 1/8"
▶ 15-0205 14,5 cm, 5 3/4"
15-0206 16,0 cm, 6 1/4"

Hohlsonden
Directors
Sondas acanaladas
Sondes cannelées
Sonde scanalate



1/2

DOYEN
15-0223
14,5 cm, 5 3/4"

Hohlsonde
Director
Sonda acanalada
Sonde cannelée
Sonda scanalata



1/2

▶ 15-0214 13,0 cm, 5 1/8"
15-0215 14,5 cm, 5 3/4"
15-0216 16,0 cm, 6 1/4"

Hohlsonden mit Knopf
Directors with button
Sondas acanaladas con boton
Sondes boutonnées cannelées
Sonde bottonute scanalate



1/2

NELATON
15-0225
16 cm, 6 1/4"

Hohlsonde mit Knopf
Director with button
Sonda acanalada con boton
Sonde boutonée cannelée
Sonda bottonuta scanalata

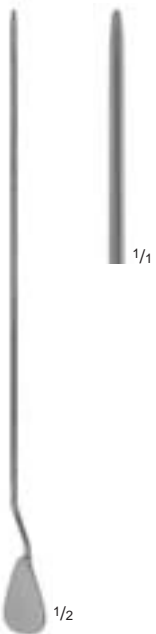

1/1

1/2

LOCKHART-MUMMERY
15-0230
16,5 cm, 6 1/2"

Fistelsonde
Fistula probe
Sonda para fistula
Sonde pour fistules
Sonda per fistole

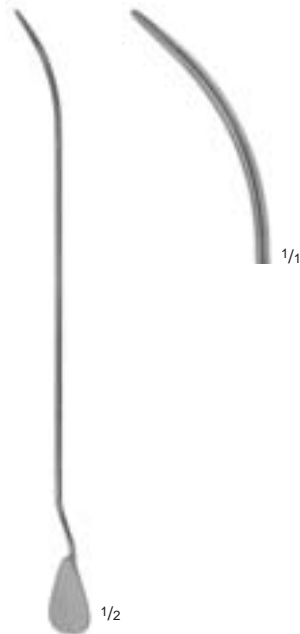

1/1

1/2

LOCKHART-MUMMERY
15-0231
16,5 cm, 6 1/2"

Fistelsonde
Fistula probe
Sonda para fistula
Sonde pour fistules
Sonda per fistole

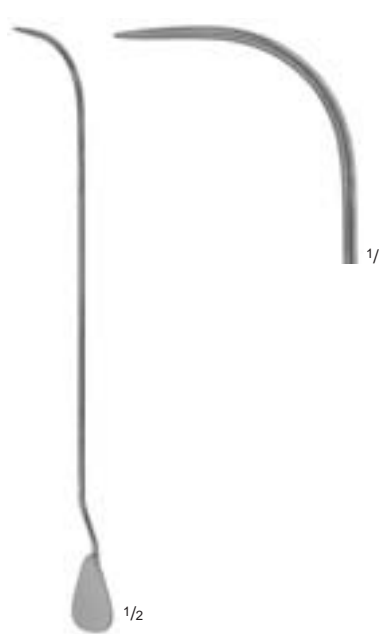

1/1

1/2

LOCKHART-MUMMERY
15-0232
16,5 cm, 6 1/2"

Fistelsonde
Fistula probe
Sonda para fistula
Sonde pour fistules
Sonda per fistole

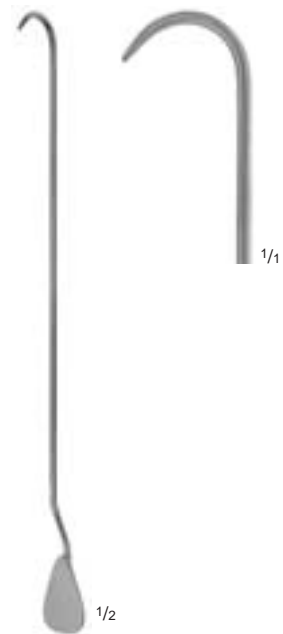

1/1

1/2

LOCKHART-MUMMERY
15-0233
16,5 cm, 6 1/2"

Fistelsonde
Fistula probe
Sonda para fistula
Sonde pour fistules
Sonda per fistole

Venenstripper
 Vein Strippers
 Sondas para várices
 Strippers à varices
 Sonde per vene

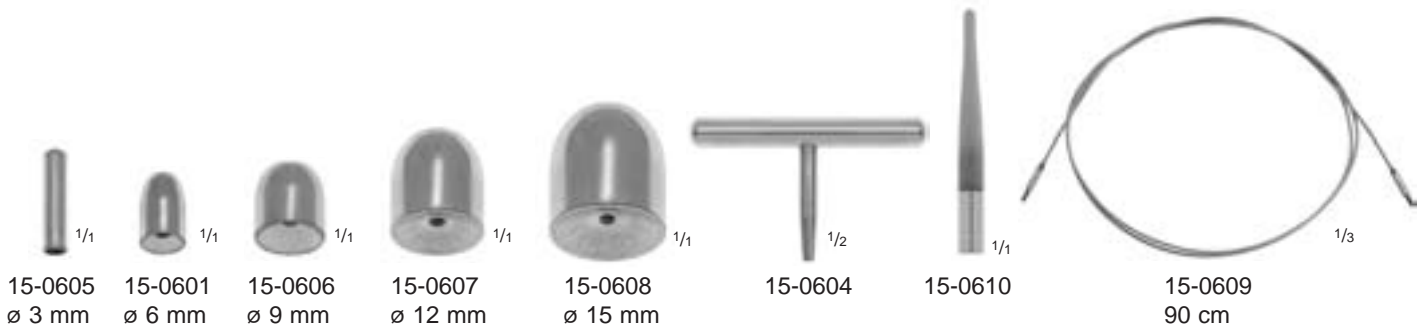
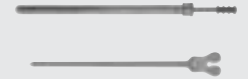

15-0605 ø 3 mm 15-0601 ø 6 mm 15-0606 ø 9 mm 15-0607 ø 12 mm 15-0608 ø 15 mm 15-0604 15-0610 15-0609 90 cm



1/4

NABATOFF
 15-0602

Krampfader-Besteck, komplett, bestehend aus:
 15-0603 1 Metalletui 135 x 100 x 25 mm
 15-0604 1 Handgriff
 15-0605 1 Metall-Sondenspitze ø 3 mm
 15-0610 1 Kunststoff-Sondenspitze
 15-0601 1 Metalloolive ø 6 mm
 15-0606 1 Metalloolive ø 9 mm
 15-0607 1 Metalloolive ø 12 mm
 15-0609 1 Zugseil, 90 cm lang

Varicose vein probe set, complete, consisting of:
 15-0603 1 Metal case 135 x 100 x 25 mm
 15-0604 1 Handle
 15-0605 1 Metal probe tip, ø 3 mm
 15-0610 1 Plastic probe tip
 15-0601 1 Metal olive, ø 6 mm
 15-0606 1 Metal olive, ø 9 mm
 15-0607 1 Metal olive, ø 12 mm
 15-0609 1 Flexible cable, 90 cm

Juego para várices, completo, compuesto de:
 15-0603 1 Estuche de metal 135 x 100 x 25 mm
 15-0604 1 Mango
 15-0605 1 Extremidad de sonda de metal, ø 3 mm
 15-0610 1 Extremidad de sonda de plástico
 15-0601 1 Oliva de metal, ø 6 mm
 15-0606 1 Oliva de metal, ø 9 mm
 15-0607 1 Oliva de metal, ø 12 mm
 15-0609 1 Cable de tracción, 90 cm

Trousse à varices, complète, composée de:
 15-0603 1 Boîte métal 135 x 100 x 25 mm
 15-0604 1 Manche
 15-0605 1 Pointe métallique, ø 3 mm
 15-0610 1 Pointe plastique
 15-0601 1 Olive métallique, ø 6 mm
 15-0606 1 Olive métallique, ø 9 mm
 15-0607 1 Olive métallique, ø 12 mm
 15-0609 1 Cable tracteur, flexible, 90 cm

Astuccio per varici, completo, compsto da:
 15-0603 1 Scatola in metallo 135 x 100 x 25 mm
 15-0604 1 Manico
 15-0605 1 Punta in materia metallo, ø 3 mm
 15-0610 1 Punta in materia plastica
 15-0601 1 Oliva in metallo, ø 6 mm
 15-0606 1 Oliva in metallo, ø 9 mm
 15-0607 1 Oliva in metallo, ø 12 mm
 15-0609 1 Fune di trazione, flessibile, 90 cm

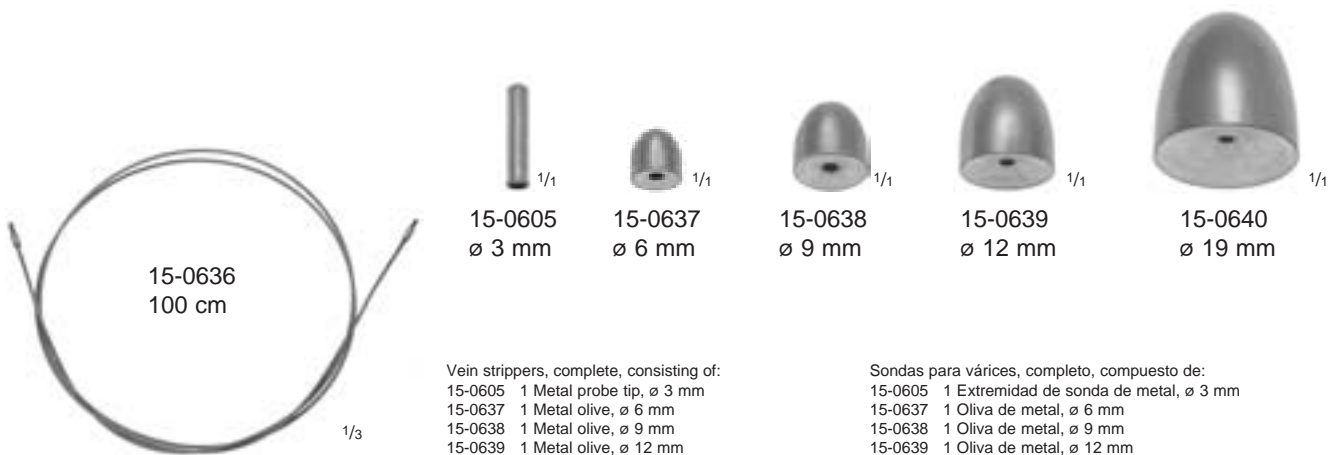

15-0636
 100 cm

15-0605 ø 3 mm 15-0637 ø 6 mm 15-0638 ø 9 mm 15-0639 ø 12 mm 15-0640 ø 19 mm

MYERS
 15-0635

Venenstripper, komplett, bestehend aus:
 15-0605 1 Metall-Sondenspitze ø 3 mm
 15-0637 1 Metalloolive ø 6 mm
 15-0638 1 Metalloolive ø 9 mm
 15-0639 1 Metalloolive ø 12 mm
 15-0640 1 Metalloolive ø 19 mm
 15-0636 1 Zugseil, 100 cm lang

Vein strippers, complete, consisting of:
 15-0605 1 Metal probe tip, ø 3 mm
 15-0637 1 Metal olive, ø 6 mm
 15-0638 1 Metal olive, ø 9 mm
 15-0639 1 Metal olive, ø 12 mm
 15-0640 1 Metal olive, ø 19 mm
 15-0636 1 Flexible cable, 100 cm

Sondas para várices, completo, compuesto de:
 15-0605 1 Extremidad de sonda de metal, ø 3 mm
 15-0637 1 Oliva de metal, ø 6 mm
 15-0638 1 Oliva de metal, ø 9 mm
 15-0639 1 Oliva de metal, ø 12 mm
 15-0640 1 Oliva de metal, ø 19 mm
 15-0636 1 Cable de tracción, 100 cm

Stripper à varices, complet, composé de:
 15-0605 1 Pointe métallique, ø 3 mm
 15-0637 1 Olive métallique, ø 6 mm
 15-0638 1 Olive métallique, ø 9 mm
 15-0639 1 Olive métallique, ø 12 mm
 15-0640 1 Olive métallique, ø 19 mm
 15-0636 1 Cable tracteur, flexible, 100 cm

Sonde per vene, completo, composto da:
 15-0605 1 Punta in materia metallo, ø 3 mm
 15-0637 1 Oliva in metallo, ø 6 mm
 15-0638 1 Oliva in metallo, ø 9 mm
 15-0639 1 Oliva in metallo, ø 12 mm
 15-0640 1 Oliva in metallo, ø 19 mm
 15-0636 1 Fune di trazione, flessibile, 100 cm

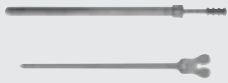

Watteträger
Cotton Applicators
Porta-algodones
Porte-cotons
Portacotone

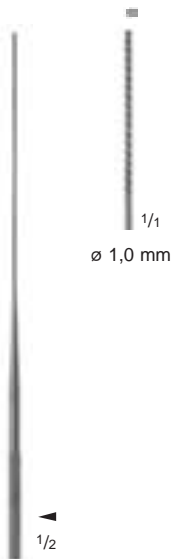

- FROHN**
 66-0308 12 cm, 4 3/4"
 ▶ 66-0309 14 cm, 5 1/2"
 66-0307 16 cm, 6 1/4"

spiralförmig gerieft
rough, spiral end
estriadura espiral
striures en spirale
zigrinatura spiraliforme

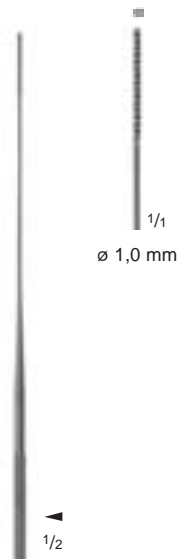

- FROHN**
 66-0310 12 cm, 4 3/4"
 ▶ 66-0311 14 cm, 5 1/2"
 66-0318 16 cm, 6 1/4"

rund kreuzgerieft
round, cross serrated end
estriadura redonda
rainures croisées
zigrinatura incrociata

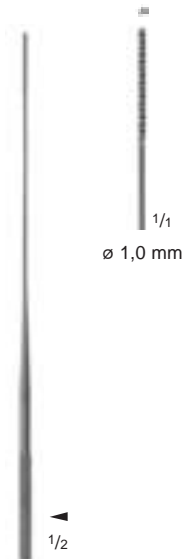

- FROHN**
 66-0312 12 cm, 4 3/4"
 ▶ 66-0313 14 cm, 5 1/2"
 66-0319 16 cm, 6 1/4"

dreikant gerieft
triangular serrated end
estriadura triangular
striures triangulaires
zigrinatura triangolare

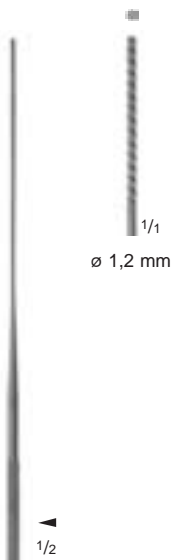

- LATHBURY (FARRELL)**
 66-0320 12 cm, 4 3/4"
 ▶ 66-0321 14 cm, 5 1/2"
 66-0322 16 cm, 6 1/4"

spiralförmig gerieft
rough, spiral end
estriadura espiral
striures en spirale
zigrinatura spiraliforme

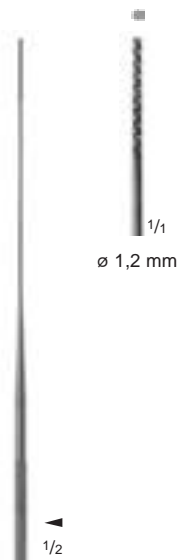

- LATHBURY (FARRELL)**
 66-0325 12 cm, 4 3/4"
 ▶ 66-0326 14 cm, 5 1/2"
 66-0327 16 cm, 6 1/4"

rund kreuzgerieft
round, cross serrated end
estriadura redonda
rainures croisées
zigrinatura incrociata

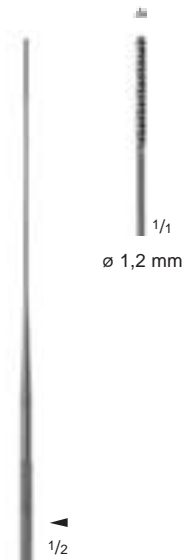

- LATHBURY (FARRELL)**
 66-0330 12 cm, 4 3/4"
 ▶ 66-0331 14 cm, 5 1/2"
 66-0332 16 cm, 6 1/4"

dreikant gerieft
triangular serrated end
estriadura triangular
striures triangulaires
zigrinatura triangolare

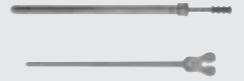

UCKERMANN
 65-0431
 16 cm, 6 1/4"

spiralförmig gerieft
 rough, spiral end
 estriadura espiral
 striures en spirale
 zigrinatura spiraliforme



JOBSON-HORNE
 65-0432
 18 cm, 7"

gerieft
 serrated end
 estriadura
 strié
 zigrinatura



PELTESON
 15-0792
 21,5 cm, 8 1/2"

spiralförmig gerieft
 rough, spiral end
 estriadura espiral
 striures en spirale
 zigrinatura spiraliforme



FEIN
 15-0793
 28 cm, 11"

spiralförmig gerieft
 rough, spiral end
 estriadura espiral
 striures en spirale
 zigrinatura spiraliforme

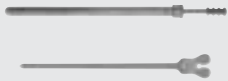

Trokare
Trocars
Trócares
Trocarts
Trequarti

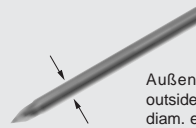

Außendurchmesser
outside diam.
diam. exterior
diamètre extérieur
diámetro externo

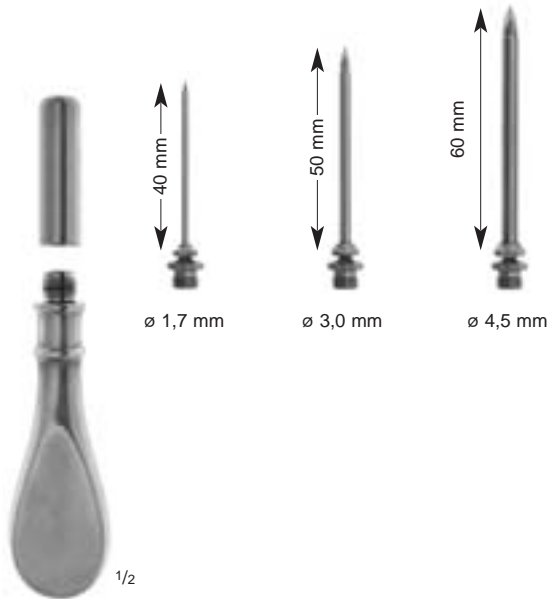

UNIVERSAL
17-0115

Trokar mit 3 Aufsätzen
Trocar with 3 tips
Trócar con 3 puntas
Trocarts avec 3 embouts
Trequarti con 3 punte

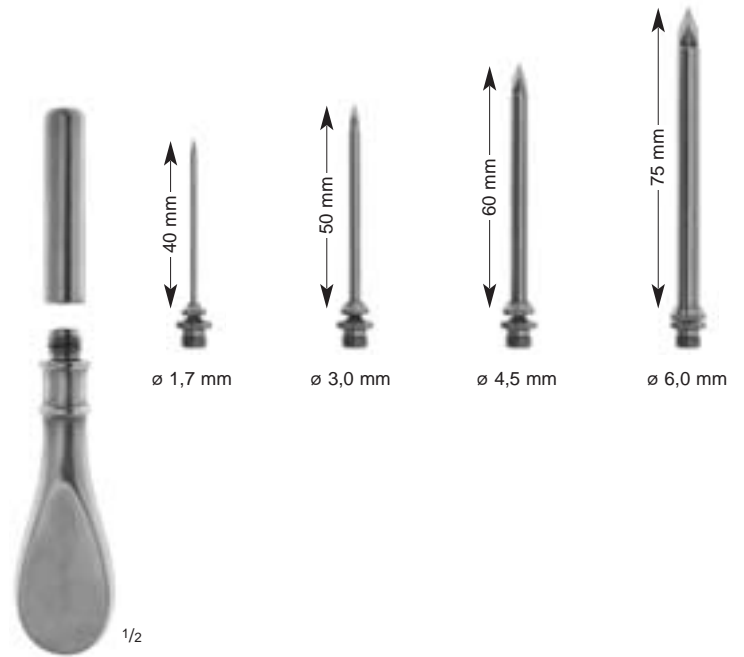

UNIVERSAL
17-0110

Trokar mit 4 Aufsätzen
Trocar with 4 tips
Trócar con 4 puntas
Trocarts avec 4 embouts
Trequarti con 4 punte

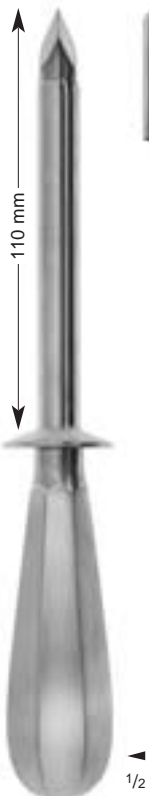

NELSON
39-0523 ø 10 mm
▶ 39-0524 ø 11 mm
21 cm, 8 1/4"

Trokare für Hydrozele
und Bauchstich
Trocars for hydrocele
and abdominal puncture
Trócares para hidrocele y
punción abdominal
Trocarts pour hydrozèle et
ponction abdominale
Trequarti per idrocele e
puntura addominale

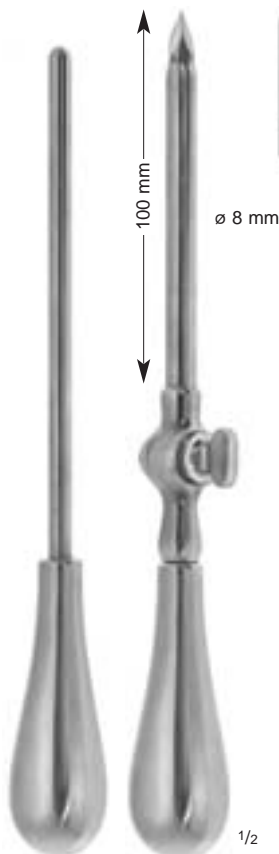

BUELAU
17-0170
22,5 cm, 9"

Empyema-Trokar
Empyema trocar
Trócar para punción torácica
Trocarts pour ponction thoracique
Trequarti per empiema

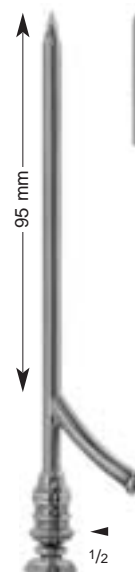

OCHSNER
11-0610 ø 3,5 mm
11-0612 ø 4,5 mm
▶ 11-0614 ø 5,0 mm
11-0616 ø 5,5 mm
11-0618 ø 6,0 mm
15 cm, 6"

Gallenblasentrokare
Gall bladder trocars
Trócares para vesícula biliar
Trocarts pour vésicule biliaire
Trequarti per vescica biliare

Kieferhöhlentrokare
 Antrum Trocars
 Trócares para el seno maxilar
 Trocarts pour le sinus maxillaire
 Trequarti per puntura del seno mascellare

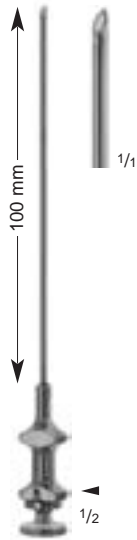
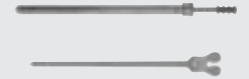

LICHTWITZ
 70-0787 ø 1,5 mm
 ▶ 70-0788 ø 1,8 mm
 70-0789 ø 2,0 mm

Kieferhöhlenpunktionskanülen
 mit LUER-Ansatz
 Antrum trocar needles with
 LUER connection
 Cánula para punción del seno
 maxilar con montura LUER-LOCK
 Trocarts pour ponction du sinus
 maxillaire avec embout LUER-LOCK
 Trequarti per puntura del seno
 mascellare con attacco LUER-LOCK

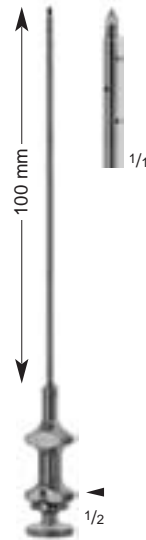

LICHTWITZ V.EICKEN
 70-0794 ø 1,5 mm
 ▶ 70-0795 ø 1,8 mm
 70-0796 ø 2,0 mm

Kieferhöhlenpunktionskanülen
 mit LUER-Ansatz
 Antrum trocar needles with
 LUER connection
 Cánula para punción del seno
 maxilar con montura LUER-LOCK
 Trocarts pour ponction du sinus
 maxillaire avec embout LUER-LOCK
 Trequarti per puntura del seno
 mascellare con attacco LUER-LOCK

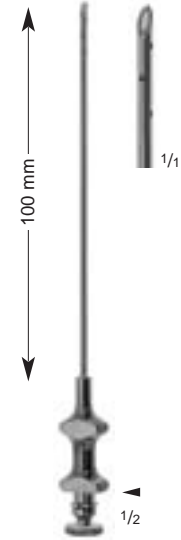

VOGEL
 70-0804 ø 1,5 mm
 ▶ 70-0805 ø 1,8 mm
 70-0806 ø 2,0 mm

Kieferhöhlenpunktionskanülen
 mit LUER-Ansatz
 Antrum trocar needles with
 LUER connection
 Cánula para punción del seno
 maxilar con montura LUER-LOCK
 Trocarts pour ponction du sinus
 maxillaire avec embout LUER-LOCK
 Trequarti per puntura del seno
 mascellare con attacco LUER-LOCK



COAKLEY
 70-0850
 15,5 cm, 6"

Kieferhöhlentrokar
 Antrum trocar
 Cánula para punción del seno maxilar
 Trocart pour le sinus maxillaire
 Trequarti per puntura del seno mascellare

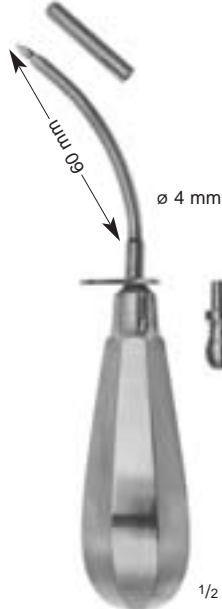

PIERCE
 70-0860
 15 cm, 6"

Kieferhöhlentrokar
 Antrum trocar
 Cánula para punción del seno maxilar
 Trocart pour le sinus maxillaire
 Trequarti per puntura del seno mascellare

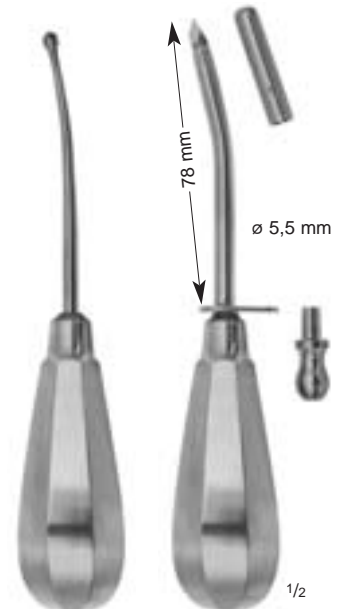

KRAUSE
 70-0865
 16 cm, 6 1/4"

Kieferhöhlentrokar
 Antrum trocar
 Cánula para punción del seno maxilar
 Trocart pour le sinus maxillaire
 Trequarti per puntura del seno mascellare

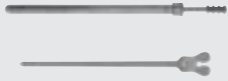

Kieferhöhlentrokare
Antrum Trocars
Trócares para el seno maxilar
Trocarts pour le sinus maxillaire
Trequarti per puntura del seno mascellare

Saugkanülen
Suction Cannulae
Cánulas para aspiración
Canules d'aspiration
Cannule per aspirazione

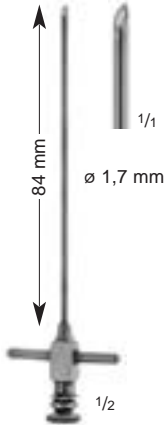

LICHTWITZ
70-0810
11 cm, 4 3/8"

Kieferhöhlentrokare
Antrum trocar
Cánula para punción del seno maxilar
Trocarts pour le sinus maxillaire
Trequarti per puntura del seno mascellare

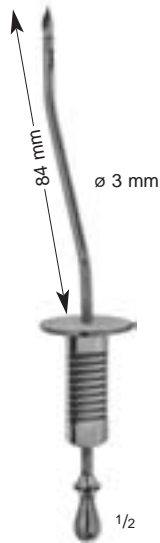

DOUGLAS
70-0840
14 cm, 5 1/2"

Kieferhöhlentrokare
Antrum trocar
Cánula para punción del seno maxilar
Trocarts pour le sinus maxillaire
Trequarti per puntura del seno mascellare



LICHTWITZ
▶ 70-0870 ø 1,8 mm
70-0871 ø 2,5 mm
18,5 cm, 7 1/4"

Kieferhöhlentrokare
Antrum trocars
Cánula para punción del seno maxilar
Trocarts pour le sinus maxillaire
Trequarti per puntura del seno mascellare



ROSEN
68-1480 ø 0,7 mm
68-1481 ø 0,9 mm
▶ 68-1482 ø 1,2 mm
10,5 cm, 8 1/8"

Saugkanülen mit LUER-LOCK Ansatz

Suction cannulae with LUER-LOCK connection

Cánulas para aspiración con montura LUER-LOCK

Canules d'aspiration avec embout LUER-LOCK

Cannule per aspirazione con attacco LUER-LOCK



ROSEN
68-1484 ø 0,7 mm
68-1485 ø 0,9 mm
▶ 68-1486 ø 1,2 mm
10,5 cm, 8 1/8"

Saugkanülen mit LUER-LOCK Ansatz

Suction cannulae with LUER-LOCK connection

Cánulas para aspiración con montura LUER-LOCK

Canules d'aspiration avec embout LUER-LOCK

Cannule per aspirazione con attacco LUER-LOCK



68-1489
6 cm, 2 3/8"

Schlauchverbindungsstück mit LUER-Konus und Unterbrecher, für 68-1480 bis 68-1486

Suction adapter with LUER cone and finger cut-off, for 68-1480 - 68-1486

Enchufe de conexión, con cono LUER y interruptor, para 68-1480 - 68-1486

Adaptateur avec cône LUER et interrupteur à doigt pour 68-1480 - 68-1486

Adattatore aspirazione con cono LUER e interruttore per 68-1480 - 68-1486



68-1488
11 cm, 4 3/8"

Saughandgriff mit LUER-Konus und Unterbrecher, für 68-1480 bis 68-1486

Suction handle with LUER cone and finger cut-off, for 68-1480 - 68-1486

Mancho para aspiración, con cono LUER y interruptor, para 68-1480 - 68-1486

Manche pour aspiraton avec cône LUER et interrupteur à doigt pour 68-1480 - 68-1486

Manico per aspirazione con cono LUER e interruttore per 68-1480 - 68-1486

Saugkanülen
Suction Cannulae
Cánulas para aspiración
Canules d'aspiration
Cannule per aspirazione

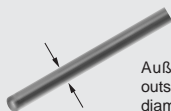

Außendurchmesser
outside diam.
diam. exterior
diamètre extérieur
diametro esterno

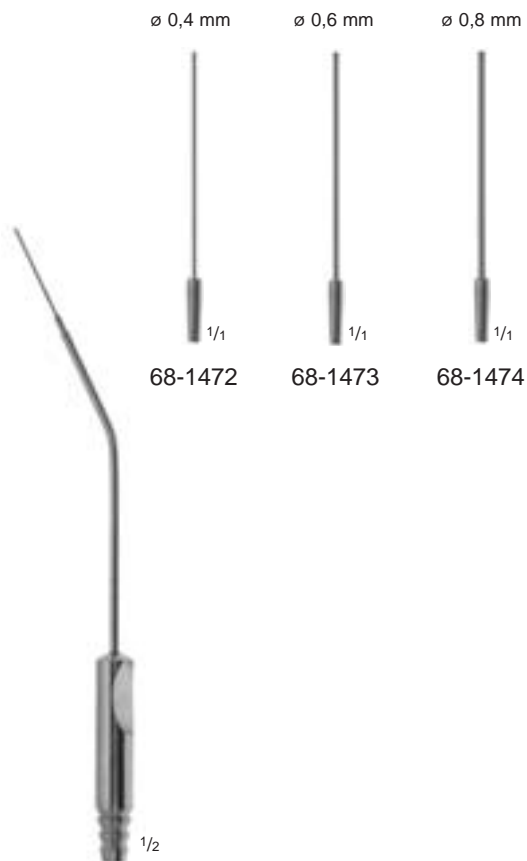
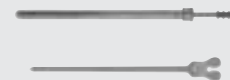

WULLSTEIN
68-1470
17 cm, 6 3/4"

Mikro-Absaugrohr, komplett, bestehend aus:
68-1471 1 Absaugrohr mit LUER-Bohrung
68-1472 1 Mikro-Saugkanüle \varnothing 0,4 mm
68-1473 1 Mikro-Saugkanüle \varnothing 0,6 mm
68-1474 1 Mikro-Saugkanüle \varnothing 0,8 mm

Micro suction tube, complete, consisting of:
68-1471 1 Suction tube with LUER hub
68-1472 1 Micro suction cannula, \varnothing 0.4 mm
68-1473 1 Micro suction cannula, \varnothing 0.6 mm
68-1474 1 Micro suction cannula, \varnothing 0.8 mm

Aspirador micro, completo, compuesto de:
68-1471 1 Tubo de aspiración, con cono LUER
68-1472 1 Cánula para aspiración micro \varnothing 0,4 mm
68-1473 1 Cánula para aspiración micro \varnothing 0,6 mm
68-1474 1 Cánula para aspiración micro \varnothing 0,8 mm

Micro-canule d'aspiration, complète, composée de:
68-1471 1 Tube d'aspiration avec cône LUER
68-1472 1 Micro-canule d'aspiration, \varnothing 0,4 mm
68-1473 1 Micro-canule d'aspiration, \varnothing 0,6 mm
68-1474 1 Micro-canule d'aspiration, \varnothing 0,8 mm

Mirco-tubo aspirazione, completo, composto da:
68-1471 1 Tubo aspirazione con perforazione LUER
68-1472 1 Micro-cannula per aspirazione \varnothing 0,4 mm
68-1473 1 Micro-cannula per aspirazione \varnothing 0,6 mm
68-1474 1 Micro-cannula per aspirazione \varnothing 0,8 mm



ZOELLNER
68-1440
18 cm, 7"

Mikro-Absaugrohr mit Saugkanüle \varnothing 0,6 mm (68-1441), Olive mit LUER-Bohrung

Micro suction tube with suction cannula \varnothing 0.6 mm (68-1441), olive with LUER hub

Aspirador micro con cánula para aspiración \varnothing 0,6 mm (68-1441), oliva con cono LUER

Micro-canule d'aspiration avec embout d'aspiration \varnothing 0,6 mm (68-1441), olive avec cône LUER

Micro-tubo aspirazione con cannula per aspirazione \varnothing 0,6 mm (68-1441), oliva con perforazione LUER



BARNES
70-0725
16 cm, 6 1/4"

Saugkanüle mit LUER-Bohrung und Unterbrecher

Suction cannula with LUER hub and finger cut-off

Cánula para aspiración con cono LUER y interruptor

Canule d'aspiration avec cône LUER et interrupteur à doigt

Cannula per aspirazione con perforazione LUER e interruttore

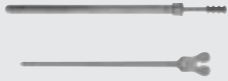

Saugkanülen
Suction Cannulae
Cánulas para aspiración
Canules d'aspiration
Cannule per aspirazione

Spülkanülen
Irrigation Cannulae
Cánulas para irrigación
Canules d'irrigation
Cannule per irrigazione

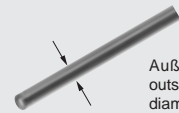

Außendurchmesser
outside diam.
diam. exterior
diamètre extérieur
diametro esterno



WULLSTEIN
68-1410
16 cm, 6 1/4"

Saugkanüle aus Silber, konisch,
Olive mit LUER-Bohrung

Suction cannula, silver, conical,
olive with LUER hub

Cánula para aspiración de plata,
cónica, oliva con cono LUER

Canule d'aspiration, en argent, cône,
olive avec cône LUER

Cannula per aspirazione, in argento,
conica, oliva con perforazione LUER



HARTMANN
65-0301 ø 2,5 mm
▶ 65-0302 ø 3,0 mm
65-0303 ø 3,5 mm
14,5 cm, 5 3/4"

Ohrkatheter
Eustachian catheters
Cateter de eustaquio
Sondes auriculaires
Sonde auricolari



EICKEN-KILLIAN
70-0670 ø 1,5 mm
▶ 70-0671 ø 2,5 mm
70-0673 ø 3,0 mm
14 cm, 5 1/2"

Kieferhöhlenspülkanülen mit LUER-Bohrung

Antrum wash cannulae with LUER hub

Cánulas para irrigación del senos maxilar con
cono LUER

Canules d'irrigation du sinus maxillaire avec
cône LUER

Cannule per irrigazione del seno mascellare
con perforazione LUER

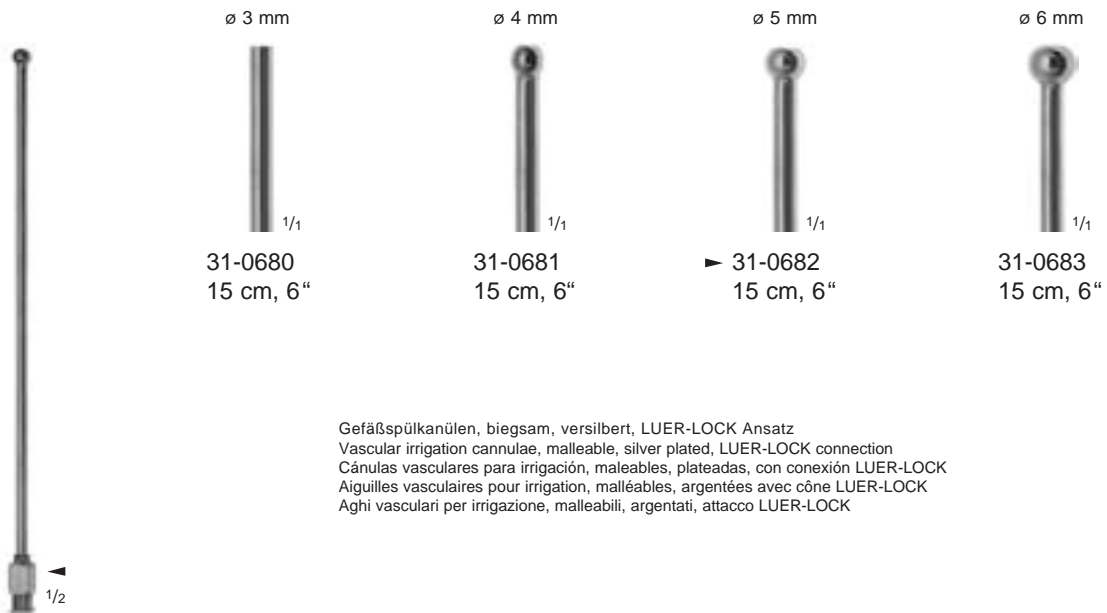

SCHMID
31-0680
- 31-0683

Gefäßspülkanülen, biegsam, versilbert, LUER-LOCK Ansatz
Vascular irrigation cannulae, malleable, silver plated, LUER-LOCK connection
Cánulas vasculares para irrigación, maleables, plateadas, con conexión LUER-LOCK
Aiguilles vasculaires pour irrigation, malléables, argentées avec cône LUER-LOCK
Aghi vascolari per irrigazione, malleabili, argentati, attacco LUER-LOCK

Saugkanülen mit Unterbrecher und Mandrin
 Suction Cannulae with finger cut-off and stylet
 Cánulas para aspiración con interruptor y estilete
 Canules d'aspiration avec interrupteur à doigt
 Cannule per aspirazione con interruttore e stiletto

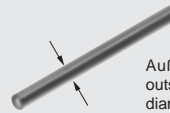

Außendurchmesser
 outside diam.
 diam. exterior
 diamètre extérieur
 diametro esterno



ADSON
 ▶ 51-0802 ø 4 mm
 51-0803 ø 5 mm
 21 cm, 8 1/4"



ADSON
 ▶ 51-0800 ø 4 mm
 51-0801 ø 5 mm
 21 cm, 8 1/4"



FRAZIER
 51-0866 ø 2,0 mm
 51-0867 ø 2,3 mm
 51-0868 ø 2,7 mm
 51-0870 ø 3,3 mm
 ▶ 51-0871 ø 3,7 mm
 20 cm, 8"



FRAZIER (FERGUSON)
 51-0806 ø 2,0 mm
 51-0807 ø 2,3 mm
 51-0808 ø 2,7 mm
 51-0810 ø 3,3 mm
 ▶ 51-0811 ø 3,7 mm
 51-0812 ø 4,0 mm
 51-0818 ø 5,0 mm
 18,5 cm, 7 1/4"



FRAZIER (FERGUSON)
 51-0828 ø 2,0 mm
 51-0829 ø 2,3 mm
 51-0830 ø 2,7 mm
 51-0832 ø 3,3 mm
 ▶ 51-0833 ø 3,7 mm
 51-0834 ø 4,0 mm
 51-0835 ø 5,0 mm
 14 cm, 5 1/2"

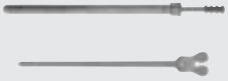

Saugrohre
Suction Tubes
Tubos para aspiración
Canules d'aspiration
Tubi aspirazione

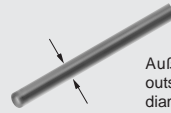

Außendurchmesser
outside diam.
diam. exterior
diamètre extérieur
diametro esterno

ø 3,0 x 6,5 mm



16-0200
15,5 cm, 6"

Nasensaugrohr mit LUER-Bohrung

Nasal suction tube with LUER hub

Tubo nasal para aspiración con cono de LUER

Canule d'aspiration nasale avec cône LUER

Tubo per aspirazione nasale con perforazione LUER



▶ 16-0202 ø 4,5 mm
16-0204 ø 5,5 mm
18,5 cm, 7 1/4"

Nasensaugrohre mit LUER-Bohrung

Nasal suction tubes with LUER hub

Tubos nasales para aspiración con cono de LUER

Canules d'aspiration nasale avec cône LUER

Tubi per aspirazione nasale con perforazione LUER



YASARGIL

16-0210 ø 1,5 mm

16-0212 ø 2,0 mm

▶ 16-0214 ø 2,5 mm

16-0216 ø 3,5 mm

22 cm, 8 3/4"

Saugrohre mit LUER-Bohrung
Suction tubes with LUER hub

Tubos para aspiración con cono de LUER

Canules d'aspiration avec cône LUER

Tubi aspirazione con perforazione LUER

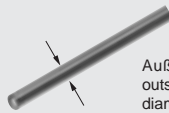

Außerdurchmesser
outside diam.
diam. exterior
diamètre extérieur
diametro esterno

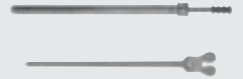

ø 10 mm



POOLE
16-0250
23,5 cm, 9 1/4"

ø 5,5 mm



POOLE
16-0265
19,5 cm, 7 3/4"

ø 8 mm



POOLE
16-0255
25 cm, 10"

ø 6 mm



ANDREW-PYNCHON
16-0274
23 cm, 9"

16-0276

Saugkopf allein
Suction basket only
Cabezal para aspiración, suelto
Embout d'aspiration seul
Solo cestello aspirazione

▼
ø 10 mm



YANKAUER
16-0275
29 cm, 11 1/2"

16-0284

Saugkopf allein
Suction basket only
Cabezal para aspiración, suelto
Embout d'aspiration seul
Solo cestello aspirazione

▼
ø 9 mm



DE BAKEY
16-0279
28 cm, 11"

mit abschraubbarem Außenrohr
with outer tube to be screwed off
con tubo exterior desentoscable
avec canule extérieure démontable
con tubo esterno svitabile

mit seitlichen Schlitzen
with lateral slots
con ranuras laterales
avec tube cannelé
con scanalature laterali

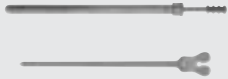

Saugrohre
Suction Tubes
Tubos para aspiración
Canules d'aspiration
Tubi aspirazione

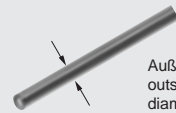

Außendurchmesser
outside diam.
diam. exterior
diamètre extérieur
diametro esterno

ø 2,6 mm



Fig. 0
16-0291

ø 3,3 mm



Fig. 1
16-0292

ø 4,8 mm



Fig. 2
16-0293

ø 10 mm



Fig. 3
16-0294

16-0276

Saugkopf allein
Suction basket only
Cabezal para aspiración, suelto
Embout d'aspiration seul
Solo cestello aspirazione

16-0276

Saugkopf allein
Suction basket only
Cabezal para aspiración, suelto
Embout d'aspiration seul
Solo cestello aspirazione

ø 10 mm



YANKAUER
16-0277
32 cm, 12 1/2"

mit Absperrventil und
abschraubbarem Rohr
with stopcock and tube
to be screwed off
con interruptor y tubo
desenroscable
avec robinet et canule
extérieure démontable
con interruttore e tubo
svitabile

16-0296



YANKAUER
16-0289
27 cm, 10 3/4"

Saugrohr, komplett, bestehend aus:
16-0291 1 Saugkanülen-Aufsatz
16-0292 1 Saugkanülen-Aufsatz
16-0293 1 Saugkanülen-Aufsatz
16-0294 1 Saugkanülen-Aufsatz
16-0296 1 Griff

Suction tube, complete, consisting of:
16-0291 1 Tip, suction cannula
16-0292 1 Tip, suction cannula
16-0293 1 Tip, suction cannula
16-0294 1 Tip, suction cannula
16-0296 1 Handle

Tubo para aspiración, completo, compuesto de:
16-0291 1 Punta, cánula para aspiración
16-0292 1 Punta, cánula para aspiración
16-0293 1 Punta, cánula para aspiración
16-0294 1 Punta, cánula para aspiración
16-0296 1 Mango

Canule d'aspiration, complète, composée de:
16-0291 1 tige canule d'aspiration
16-0292 1 tige canule d'aspiration
16-0293 1 tige canule d'aspiration
16-0294 1 tige canule d'aspiration
16-0296 1 Manche

Tubo aspirazione, completo, composto di:
16-0291 1 punta cannula per aspirazione
16-0292 1 punta cannula per aspirazione
16-0293 1 punta cannula per aspirazione
16-0294 1 punta cannula per aspirazione
16-0296 1 Manico

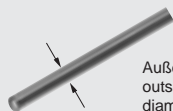

Außendurchmesser
outside diam.
diam. exterior
diamètre extérieur
diametro esterno

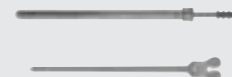

ø 8 mm



COOLEY
16-0267
36 cm, 14"

Saugrohr
Suction tube
Tubo para aspiración
Canule d'aspiration
Tubo aspirazione

16-0271

Saugkopf allein
Suction basket only
Cabezal para aspiración, suelto
Embout d'aspiration seul
Solo cestello aspirazione



ø 7 mm



COOLEY
16-0268
31 cm, 12 1/4"

Gefäßsaugrohr
Vascular suction tube
Tubo para aspiración
vascular
Canule d'aspiration
vasculaire
Tubo aspirazione
vascolare

16-0272

Saugkopf allein
Suction basket only
Cabezal para aspiración, suelto
Embout d'aspiration seul
Solo cestello aspirazione



ø 10 mm



COOLEY
16-0269
31 cm, 12 1/4"

Intracardiac Saugrohr
Intracardiac suction tube
Tubo para aspiración
intracardiaco
Canule d'aspiration
intra-cardiaque
Tubo aspirazione
intracardiaca

ø 8 mm

16-0273

Saugkopf allein
Suction basket only
Cabezal para aspiración, suelto
Embout d'aspiration seul
Solo cestello aspirazione



COOLEY
16-0270
35 cm, 13 3/4"

Saugrohr für linken Ventrikel,
mit abschraubbarem Rohr
Left ventricular sump suction tube,
with tube to be screwed off
Tubo para aspiración, para el ventrículo
izquierdo, con tubo desenroscable
Canule d'aspiration, pour ventricule
gauche avec tige démontable
Tubo aspirazione, ventricolare
sinistra con tubo svitabile

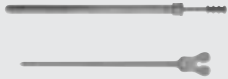

Spezialkanülen
Special Needles
Agujas especiales
Aiguilles spéciales
Aghi speciali

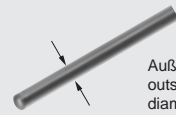

Außendurchmesser
outside diam.
diam. exterior
diamètre extérieur
diametro esterno



- TUOHY**
18-0407 ø 1,2 mm x 76 mm
▶ 18-0408 ø 1,4 mm x 76 mm
18-0409 ø 1,6 mm x 76 mm

Kanülen zur Lumbalpunktion
Lumbar puncture needles
Agujas para punción lumbar
Aiguilles pour ponction lombaire
Aghi per punture lombari



- QUINKE**
18-0422 ø 0,7 mm x 50 mm
18-0423 ø 0,7 mm x 76 mm
18-0424 ø 0,7 mm x 89 mm
18-0425 ø 1,0 mm x 76 mm
18-0426 ø 1,0 mm x 89 mm
18-0427 ø 1,2 mm x 76 mm
▶ 18-0428 ø 1,2 mm x 89 mm

Kanülen zur Lumbalpunktion
Lumbar puncture needles
Agujas para punción lumbar
Aiguilles pour ponction lombaire
Aghi per punture lombari



77-0685
ø 0,8 mm

Tonsillenkanüle
Tonsil needle
Aguja para amígdala
Aiguille pour amygdales
Ago per tonsille



77-0686
ø 0,8 mm

Tonsillenkanüle
Tonsil needle
Aguja para amígdala
Aiguille pour amygdales
Ago per tonsille



77-0687
ø 0,8 mm

Septumkanüle
Septum needle
Aguja para el tabique nasal
Aiguille pour la cloison nasale
Ago per setto nasale



77-0688
ø 0,8 mm

Septumkanüle
Septum needle
Aguja para el tabique nasal
Aiguille pour la cloison nasale
Ago per setto nasale

Biopsiekanülen
Biopsy Needles
Agujas para biopsia
Aiguilles à biopsie
Aghi per biopsia

Peritoneal-Pneu-Kanülen
Pneumoperitoneum Needles
Agujas para el neumoperitoneo
Aiguilles pour le pneumopéritoine
Aghi per il pneumo-peritoneo

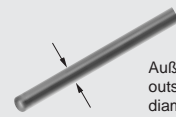

Außendurchmesser
outside diam.
diam. exterior
diamètre extérieur
diametro esterno

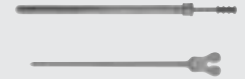

- MENGHINI**
- 18-0481 ø 1,0 mm x 35 mm
 - 18-0482 ø 1,0 mm x 70 mm
 - 18-0483 ø 1,2 mm x 70 mm
 - 18-0484 ø 1,2 mm x 100 mm
 - 18-0485 ø 1,4 mm x 70 mm
 - ▶ 18-0486 ø 1,4 mm x 100 mm
 - 18-0487 ø 1,6 mm x 70 mm
 - 18-0488 ø 1,8 mm x 100 mm

Kanülen für die Leberblindpunktion
Liver blind puncture needles
Agujas para la punción ciega del hígado
Aiguilles pour la ponction aveugle du foie
Aghi per la puntura cieca del fegato

1/2

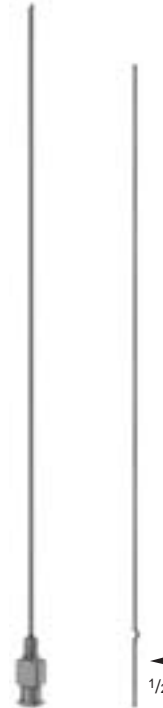

- MENGHINI**
- ▶ 18-0490 ø 1,4 mm x 168 mm
 - 18-0491 ø 1,8 mm x 168 mm

Kanülen zur gezielten Leberpunktion
Needles for controlled liver puncture
Agujas para la punción del hígado bajo el control laparoscópico
Aiguilles pour la ponction contrôlée du foie
Aghi per la puntura controllata del fegato

1/2



- KLIMA-ROSEGGER**
- 18-0421 ø 1,2 mm x 35 mm
 - ▶ 18-0420 ø 1,8 mm x 35 mm

Kanülen zur Sternalpunktion
Sternum puncture needles
Agujas para la punción del esternón
Aiguilles pour la ponction sternale
Aghi per la puntura dello sterno

1/2



- ABRAMS**
- 39-0500
 - ø 4 mm x 90 mm

Kanüle zur Brustfellpunktion
Pleura puncture needle
Aguja para la punción de la pleura
Aiguille pour la ponction de la plèvre
Ago per la puntura della pleura

1/2



- VERESS**
- 49-4260 ø 2,5 mm x 100 mm
 - ▶ 49-4262 ø 2,5 mm x 120 mm
 - 49-4264 ø 2,5 mm x 140 mm

Peritoneal-Pneu-Kanülen
Pneumoperitoneum needles
Agujas para el neumoperitoneo
Aiguilles pour le pneumopéritoine
Aghi per il pneumo-peritoneo

1/2

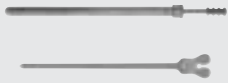

Spritzen
Syringes
Jeringas
Seringues
Siringhe



1/2

- 77-0607 1 ml (40)
- ▶ 77-0608 2 ml (80)

Insulin-Spritzen mit LUER-Konus
Insuline syringes with LUER cone
Jeringas para insulina con cono LUER
Seringues pour insuline avec cône LUER
Siringhe da insulina cono LUER



1/2

- 77-0610
1 ml (100)

Tuberkulin-Spritze mit LUER-Konus
Tuberkuline syringe with LUER cone
Jeringa para tuberculina con cono LUER
Seringue pour tuberculine avec cône LUER
Siringa da tuberculina cono LUER



1/2

- 77-0650 1 ml
- 77-0651 2 ml
- ▶ 77-0652 5 ml
- 77-0653 10 ml
- 77-0654 20 ml
- 77-0655 50 ml

Spritzen mit LUER-Konus
Syringes with LUER cone
Jeringas con cono LUER
Seringues avec cône LUER
Siringhe cono LUER



1/2

- 77-0670 1 ml
- 77-0671 2 ml
- ▶ 77-0672 5 ml
- 77-0673 10 ml
- 77-0674 20 ml
- 77-0675 50 ml

Spritzen mit LUER-LOCK-Ansatz
Syringes with LUER-LOCK connection
Jeringas con conexión LUER-LOCK
Seringues avec verrou LUER-LOCK
Siringhe con attacco LUER-LOCK



1/2

- 77-1607 1 ml (40)
- ▶ 77-1608 2 ml (80)

Zylinder mit LUER-Konus
Barrels with LUER cone
Cilindros con cono LUER
Cylindres avec cône LUER
Cilindri con cono LUER



1/2

- 77-1610
1 ml (100)

Zylinder mit LUER-Konus
Barrel with LUER cone
Cilindros con cono LUER
Cylindre avec cône LUER
Cilindro con cono LUER



1/2

- 77-1650 1 ml
- 77-1651 2 ml
- ▶ 77-1652 5 ml
- 77-1653 10 ml
- 77-1654 20 ml
- 77-1655 50 ml

Zylinder mit LUER-Konus
Barrels with LUER cone
Cilindros con cono LUER
Cylindres avec cône LUER
Cilindri con cono LUER



1/2

- 77-1670 1 ml
- 77-1671 2 ml
- ▶ 77-1672 5 ml
- 77-1673 10 ml
- 77-1674 20 ml
- 77-1675 50 ml

Zylinder mit LUER-LOCK-Ansatz
Barrels with LUER-LOCK connection
Cilindros con conexión LUER-LOCK
Cylindres avec verrou LUER-LOCK
Cilindri con attacco LUER-LOCK

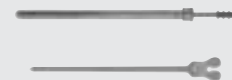

- 77-0680 2 ml
- ▶ 77-0682 5 ml
- 77-0684 10 ml

Spritzen mit LUER-LOCK-Ansatz und drehbaren Ringen

Syringes with LUER-LOCK connection and revolving rings

Jeringas con conexión LUER-LOCK y anillos girables

Seringues avec verrou LUER-LOCK et anneaux revolver

Siringhe con attacco LUER-LOCK e anelli girevoli



- 77-1680 2 ml
- ▶ 77-1682 5 ml
- 77-1684 10 ml

Zylinder mit LUER-LOCK-Ansatz
 Barrels with LUER-LOCK connection
 Cilindros con conexión LUER-LOCK
 Cylindres avec verrou LUER-LOCK
 Cilindri con attacco LUER-LOCK



77-0698

77-0699



JANET

- 77-0690 50 ml
- ▶ 77-0691 100 ml
- 77-0692 150 ml
- 77-0693 200 ml

Wund- und Blasenspritzen mit 1 konischen (77-0698) und 1 olivenförmigen Ansatz (77-0699)

Wound and bladder syringes with 1 conical tip (77-0698) and 1 bulbous tip (77-0699)

Jeringas para enjuagar la vejiga y heridas con 1 punta cónica (77-0698) y 1 punta forma oliva (77-0699)

Seringues vésicales avec 1 embout conique (77-0698) et 1 embout olivaire (77-0699)

Siringhe per ferite e vescica con 1 punta conica (77-0698) e 1 punta a oliva (77-0699)



JANET

- 77-1690 50 ml
- ▶ 77-1691 100 ml
- 77-1692 150 ml
- 77-1693 200 ml

Zylinder
 Barrels
 Cilindros
 Cylindres
 Cilindri

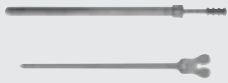

Spritzen
Syringes
Jeringas
Seringues
Siringhe

65-0361
10 ml

- Selbstfüller-Ohrspritze, komplett, bestehend aus:
 65-0362 1 Spritze, mit LUER-LOCK-Ansatz
 65-0363 1 Ventil-System, mit LUER-LOCK-Ansatz
 65-0388 1 Schutzsteller
 65-0366 1 Ohr-Olive
 65-0386 1 Ansatz, konisch
 65-0387 1 Ansatz, olivenförmig
 65-0368 1 Katheter-Ansatz
 65-0369 1 Saugfuß
 65-0370 1 Saug-Schlauch, 45 cm
 65-0371 1 O-Ring für Spritzen-Kolben
 65-0372 1 Kunststofftasche

- Self-filling ear syringe, complete, consisting of:
 65-0362 1 Syringe, with LUER-LOCK connection
 65-0363 1 Valve attachment, with LL connection
 65-0388 1 Protecting disc
 65-0366 1 Ear olive
 65-0386 1 Conical tip
 65-0387 1 Bulbous tip
 65-0368 1 Catheter tip
 65-0369 1 Suction piece
 65-0370 1 Rubber tube, 45 cm
 65-0371 1 O-ring for piston
 65-0372 1 Plastic bag

- Jeringa auricular, auto-rellena, completa, compuesta de:
 65-0362 1 Jeringa con cono LUER-LOCK
 65-0363 1 Valvula de conexión con cono LUER-LOCK
 65-0388 1 Disco protector
 65-0366 1 Oliva para los oídos
 65-0386 1 Punta cónica
 65-0387 1 Punta forma oliva
 65-0368 1 Sonda
 65-0369 1 Pieza para aspiración
 65-0370 1 Tubo de goma para aspiración, 45 cm
 65-0371 1 Anillo-O para pistón
 65-0372 1 Bolsa de plástico

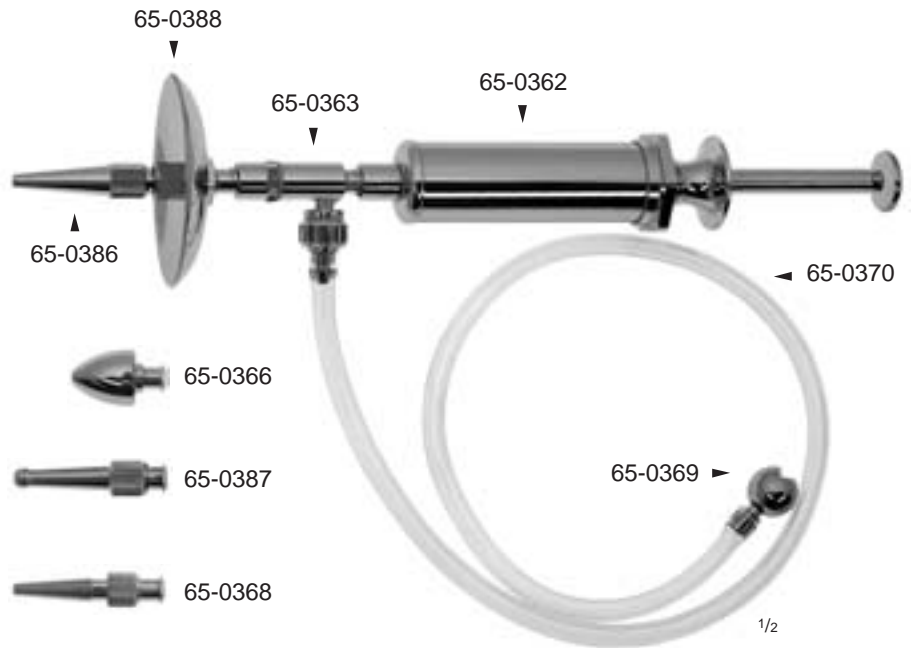

- Seringue auriculaire à remplissage automatique, complète, composée de:
 65-0362 1 Seringue cône LUER-LOCK
 65-0363 1 Raccord LUER-LOCK
 65-0388 1 Disque protecteur
 65-0366 1 Embout olivaire
 65-0386 1 Embout conique
 65-0387 1 Embout à fistule
 65-0368 1 Embout pour catheter
 65-0369 1 Embout aspiration
 65-0370 1 tube, 45 cm
 65-0371 1 Joint pour piston
 65-0372 1 Etui en plastique

- Siringa per orecchio ad autorimpimento, completa, composta da:
 65-0362 1 Siringa cono LUER-LOCK
 65-0363 1 Valvola di connessione
 65-0388 1 Disco protettore
 65-0366 1 Oliva
 65-0386 1 Punta conica
 65-0387 1 Punta a oliva
 65-0368 1 Sonda
 65-0369 1 Aspiratore
 65-0370 1 Tubo in gomma da 45 cm
 65-0371 1 Anello O per pistone
 65-0372 1 Borsa in plastica

▶ 65-0379
50 ml

- Ohrspritze, komplett, bestehend aus:
 65-0389 1 Spritze, mit LUER-LOCK-Ansatz
 65-0386 1 Ansatz, konisch
 65-0387 1 Ansatz, olivenförmig
 65-0388 1 Schutzsteller

- Ear syringe, complete, consisting of:
 65-0389 1 Syringe, with LUER-LOCK connection
 65-0386 1 Conical tip
 65-0387 1 Bulbous tip
 65-0388 1 Protecting disc

- Jeringa auricular, completa, compuesta de:
 65-0389 1 Jeringa con cono LUER-LOCK
 65-0386 1 Punta cónica
 65-0387 1 Punta forma oliva
 65-0388 1 Disco protector

- Seringue auriculaire, complète, composée de:
 65-0389 1 Seringue avec cône LUER-LOCK
 65-0386 1 Embout conique
 65-0387 1 Embout à fistule
 65-0388 1 Disque protecteur

- Siringa per orecchio completa, composta da:
 65-0389 1 Siringa con attacco LUER-LOCK
 65-0386 1 Punta conica
 65-0387 1 Punta a oliva
 65-0388 1 Disco protettore



- 65-0380
dito, jedoch 75 ml
ditto, but 75 ml
idem, 75 ml
idem, 75 ml

- 65-0382
dito, jedoch 100 ml
ditto, but 100 ml
idem, 100 ml
idem, 100 ml

- 65-0384
dito, jedoch 150 ml
ditto, but 150 ml
idem, 150 ml
idem, 150 ml

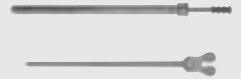

77-0877

Zwischenstück,
LUER-LOCK weiblich,
Schlaucholive für
3/16" - Schlauch

Connecting piece,
LUER-LOCK female,
olive for 3/16" tubings

Pieza de conexión,
LUER-LOCK hembra,
oliva para tubos de 3/16"

Raccord, LUER-LOCK femelle,
olive au tuyau pour tubes
de 3/16"

Raccordo, LUER-LOCK
femmina, oliva di collegamento
per tubo 3/16"



77-0878

Zwischenstück,
LUER-LOCK männlich,
Schlaucholive für
6 mm Schlauch

Connecting piece,
LUER-LOCK male,
olive for 6 mm tubings

Pieza de conexión,
LUER-LOCK masculino,
oliva para tubos de 6 mm

Raccord, LUER-LOCK
mâle, au tuyau pour tubes
de 6 mm

Raccordo, LUER-LOCK
maschio, oliva di collegamento
per tubo da 6 mm



65-0366

Zwischenstück,
LUER-LOCK weiblich,
Harnröhren-Olive

Connecting piece,
LUER-LOCK female,
urethral olive

Pieza de conexión,
LUER-LOCK hembra,
oliva uretral

Raccord, LUER-LOCK
femelle, olive urétrale

Raccordo, LUER-LOCK
femmina, oliva uretrale



65-0368 ø 2,5 - 6,5 mm

Zwischenstück,
LUER-LOCK weiblich, konischer
Schlauch- und Katheteransatz

Connecting piece,
LUER-LOCK female, conical tubing
and catheter fitting

Pieza de conexión,
LUER-LOCK hembra, cónica
cono para tubo y catéter

Raccord, LUER-LOCK femelle,
pour tubes cône et cathéters

Raccordo, LUER-LOCK femmina,
cono per tubo e catetere



77-0883

Durchflußhahn,
LUER-LOCK weiblich,
LUER-LOCK männlich

Stopcock,
LUER-LOCK female,
LUER-LOCK male

Llave,
LUER-LOCK hembra,
LUER-LOCK masculino

Robinet,
LUER-LOCK femelle,
LUER-LOCK mâle

Rubinetto,
LUER-LOCK femmina,
LUER-LOCK maschio



77-0884

Dreiweghahn,
2 x LUER-LOCK weiblich,
1 x LUER-LOCK männlich

Three-way-stopcock,
2 x LUER-LOCK female,
1 x LUER-LOCK male

Llave de 3 vías,
2 x LUER-LOCK hembra,
1 x LUER-LOCK masculino

Robinet à trois voies,
2 x LUER-LOCK femelle,
1 x LUER-LOCK mâle

Rubinetto a tre vie,
2 x LUER-LOCK femmina,
1 x LUER-LOCK maschio

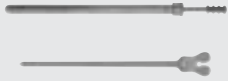

Führungsnadeln
 Guide Needles
 Aguja de guía
 Aiguilles guides
 Aghi per introduzione



REDON

- 18-0520 ø 2,5 mm
- 18-0521 ø 3,5 mm
- ▶ 18-0522 ø 4,0 mm
- 18-0523 ø 4,5 mm
- 18-0524 ø 5,5 mm
- 18-0525 ø 6,0 mm
- 19,5 cm, 7^{3/4}"

mit Lanzettenspitze
 with lancet tip
 con punta lanceolar
 avec pointe lancéolaire
 con lancetta



REDON

- 18-0530 ø 2,5 mm
- 18-0531 ø 3,5 mm
- ▶ 18-0532 ø 4,0 mm
- 18-0533 ø 4,5 mm
- 18-0534 ø 5,5 mm
- 18-0535 ø 6,0 mm
- 19,5 cm, 7^{3/4}"

mit Messerschneide
 with knife-edge
 con filo de cuchillo
 avec pointe effilée
 con bordo tagliente



REDON

- 18-0540 ø 2,5 mm
- 18-0541 ø 3,5 mm
- ▶ 18-0542 ø 4,0 mm
- 18-0543 ø 4,5 mm
- 18-0544 ø 5,5 mm
- 18-0545 ø 6,0 mm
- 16 cm, 6^{1/4}"

mit Messerschneide
 with knife-edge
 con filo de cuchillo
 avec pointe effilée
 con bordo tagliente

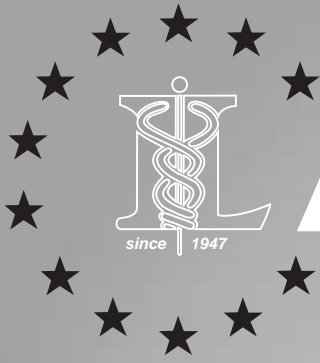

LAWNTON

Medizintechnik

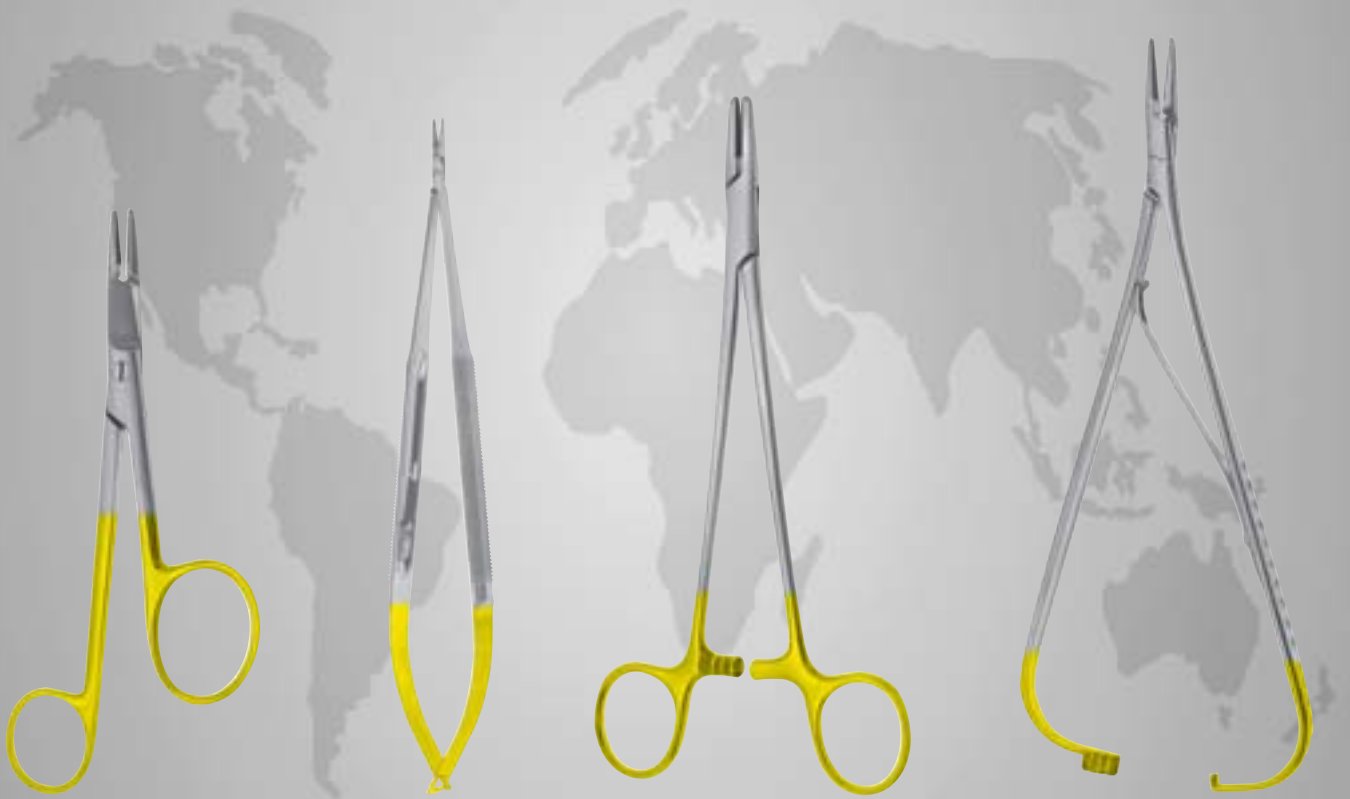

TITE GRIP® Nadelhalter
TITE GRIP® Needle Holders
TITE GRIP® Porta-agujas
TITE GRIP® Porte-aiguilles
TITE GRIP® Portaghi

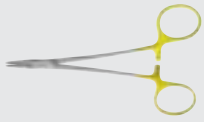

TITE GRIP® Nadelhalter mit Hartmetalleinlagen
TITE GRIP® Needle Holders with tungsten carbide inserts
TITE GRIP® Porta-agujas con bocas de carburo tungsteno
TITE GRIP® Porte-aiguilles avec mors en tungstène
TITE GRIP® Portaghi con morsi in carburo di tungsteno

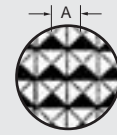

Riefung
Serration
Estradadura
Structure
Struttura



- Hartmetalleinlagen mit präzis gearbeitetem Pyramidenprofil garantieren einen sicheren Halt der Nadel.
Gebrochene Kanten verhindern ein Verfangen des Nahtmaterials.
Leichtgängige Sperre ermöglicht eine sichere Arbeitsweise.
Vergoldete Griffe als leichte Kennzeichnung.
- Tungsten carbide inserts with precisely worked out structure guarantee to grip the needle securely.
Bevelled edges to prevent catching of suture material.
Soft working catch provides safe handling.
Gold-plated handles for easy identification.
- Capas intermedias de carburo tungsteno con perfil amoldado piramidal que garantiza un sujeto seguro de la aguja.
Bordes quebrados evitan que se enredare el material de sutura.
El cierre suave facilita un manejo seguro.
Identificación: Mangos dorados.
- Les inserts en carbure de tungstène avec structure pyramidale usinée avec précision garantissent un maintien sûr de l'aiguille.
Les bords carrés empêchent le matériel de suture de s'embrouiller.
Un blocage souple permet de travailler de manière sûre.
Les branches plaquées or, un signe distinctif éloquent
- Inserti in carburo di tungsteno che garantiscono una perfetta tenuta dell'ago
I bordi squadrati evitano che si impiglino i fili di sutura
Il bloccaggio leggero e preciso facilita un uso sicuro
L'impugnatura dorata permette una facile identificazione

TITE GRIP® Nadelhalter mit Hartmetalleinlagen
 TITE GRIP® Needle Holders with tungsten carbide inserts
 TITE GRIP® Porta-agujas con bocas de carburo tungsteno
 TITE GRIP® Porte-aiguilles avec mors en tungstène
 TITE GRIP® Portaghi con morsi in carburo di tungsteno

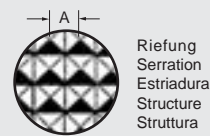

Je nach Anwendungsgebiet stehen für TITE GRIP® Nadelhalter unterschiedliche Hartmetalleinlagen zur Verfügung:

According to the field of application, there are various types of tungsten carbide inserts for TITE GRIP® needle holders:

Según campo de aplicación, disponemos de TITE GRIP® porta-agujas con varias capas intermedias:

Selon le domaine d'application, différents inserts en carbure de tungstène sont disponibles pour les porte-aiguilles TITE GRIP®:

A seconda delle necessità disponiamo di TITE GRIP® portaghi con varie capacità intermedie:

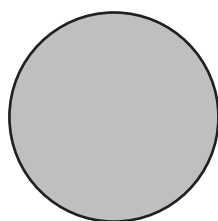

10x



1/1

GLATT • SMOOTH • LISO • LISSES • LISCIE:

Zum Halten von extrem feinem Nahtmaterial.

For holding the smallest suture sizes.

Para sujetar suturas muy finas.

Pour maintenir un matériel de suture extrêmement fin.

Per lavorare con suture sottilissime

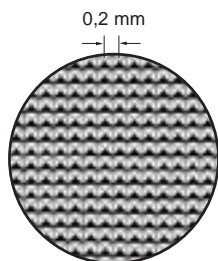

10x



0,2

RIEFUNG 0,2 MM • SERRATION 0.2 MM • ESTRIADURA 0,2 MM
 STRUCTURE 0,2 MM • STRUTTURA 0,2 MM:

Zum Halten von feinem Nahtmaterial der Stärken 7/0 bis 10/0.

For holding the delicate suture sizes from 7/0 to 10/0.

Para sujetar suturas finas de 7/0 hasta 10/0 de gruesas.

Pour maintenir un matériel de suture fin de 7/0 à 10/0.

Per lavorare con suture sottili da 7/0 a 10/0

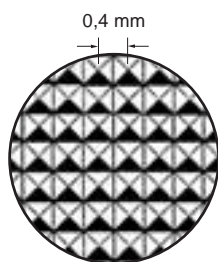

10x



0,4

RIEFUNG 0,4 MM • SERRATION 0.4 MM • ESTRIADURA 0,4 MM
 STRUCTURE 0,4 MM • STRUTTURA 0,4 MM:

Zum Halten von Nahtmaterial der Stärken 4/0 bis 6/0.

For holding the suture sizes from 4/0 to 6/0.

Para sujetar sutura de 4/0 hasta 6/0 de gruesas.

Pour maintenir un matériel de suture de 4/0 à 6/0 épaisseur.

Per lavorare con suture da 4/0 a 6/0

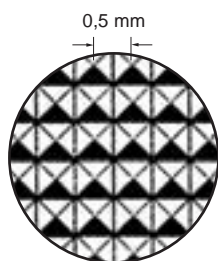

10x



0,5

RIEFUNG 0,5 MM • SERRATION 0.5 MM • ESTRIADURA 0,5 MM
 STRUCTURE 0,5 MM • STRUTTURA 0,5 MM:

Zum Halten von Nahtmaterial der Stärke 3/0 und kräftiger.

For holding the suture size 3/0 and larger.

Para sujetar sutura de 3/0 y más gruesas.

Pour maintenir un matériel de suture de 3/0 et plus.

Per lavorare con suture da 3/0 in poi

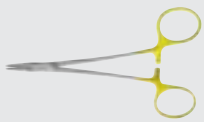

TITE GRIP® Mikro-Nadelhalter mit Hartmetalleinlagen
 TITE GRIP® Micro Needle Holders with tungsten carbide inserts
 TITE GRIP® Micro-Porta-agujas con bocas de carburo tungsteno
 TITE GRIP® Micro-Porte-aiguilles avec mors en tungstène
 TITE GRIP® Micro-Portaghi con morsi in carburo di tungsteno

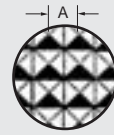

Riefung
 Serration
 Estradadura
 Structure
 Strutturata



 1/1
 glatt • smooth
 liso • lisses
 lisce

▶ 08-0043
 14 cm, 5 1/2"

 1/1
 glatt • smooth
 liso • lisses
 lisce

08-0044
 14 cm, 5 1/2"

CASTROVIEJO
 08-0043
 - 08-0044



 1/1
 0,2 mm (A)

▶ 08-0096
 14 cm, 5 1/2"

 1/1
 0,2 mm (A)

08-0097
 14 cm, 5 1/2"

CASTROVIEJO
 08-0096
 - 08-0097



 1/1
 glatt • smooth
 liso • lisses
 lisce

▶ 25-0294
 18 cm, 7"

 1/1
 glatt • smooth
 liso • lisses
 lisce

25-0297
 21 cm, 8 1/4"

JACOBSON
 25-0294
 - 25-0297



 1/1
 0,2 mm (A)

▶ 25-0296
 18 cm, 7"

 1/1
 0,2 mm (A)

25-0299
 21 cm, 8 1/4"

JACOBSON
 25-0296
 - 25-0299



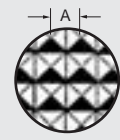

TITE GRIP® Mikro-Nadelhalter mit Hartmetalleinlagen
 TITE GRIP® Micro Needle Holders with tungsten carbide inserts
 TITE GRIP® Micro-Porta-agujas con bocas de carburo tungsteno
 TITE GRIP® Micro-Porte-aiguilles avec mors en tungstène
 TITE GRIP® Micro-Portaghi con morsi in carburo di tungsteno

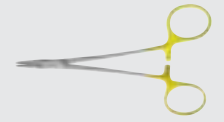

Riefung
 Serration
 Estriadura
 Structure
 Struttura



25-0275
 - 25-0278

| | |
|---|---|
|  |  |
| 0,2 mm (A) 25-0275 15 cm, 6" | 0,2 mm (A) ▶ 25-0276 18 cm, 7" |
|  |  |
| 0,2 mm (A) 25-0277 21 cm, 8 1/4" | 0,2 mm (A) 25-0278 23 cm, 9" |







CASTROVIEJO
 08-0049
 13 cm, 5 1/8"

 glatt
 smooth
 liso
 lisses
 liscie



DIETRICH
 08-0001
 - 08-0005

| | | | | |
|---|---|---|---|---|
|  |  |  |  |  |
| 0,2 mm (A) ▶ 08-0001 16 cm, 6 1/4" | 0,2 mm (A) 08-0002 18 cm, 7" | 0,2 mm (A) 08-0003 20 cm, 8" | 0,2 mm (A) 08-0004 23 cm, 9" | 0,2 mm (A) 08-0005 26 cm, 10 1/4" |



TITE GRIP® Nadelhalter mit Hartmetalleinlagen
 TITE GRIP® Needle Holders with tungsten carbide inserts
 TITE GRIP® Porta-agujas con bocas de carburo tungsteno
 TITE GRIP® Porte-aiguilles avec mors en tungstène
 TITE GRIP® Portaghi con morsi in carburo di tungsteno

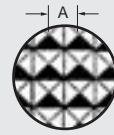

Riefung
 Serration
 Estradatura
 Structure
 Struttura



0,2 mm (A)
 08-0080
 13 cm, 5 1/8"



0,2 mm (A)
 08-0081
 15 cm, 6"



0,4 mm (A)
 08-0057
 14,5 cm 5 3/4"



0,4 mm (A)
 ▶ 08-0058
 17,5 cm 7"



0,5 mm (A)
 08-0221
 16 cm 6 1/4"



0,5 mm (A)
 ▶ 08-0223
 18,5 cm 7 1/4"



0,2 mm (A)
 ▶ 08-0084
 18,5 cm 7 1/4"



0,2 mm (A)
 08-0085
 20 cm, 8"



0,4 mm (A)
 08-0051
 20 cm, 8"



0,4 mm (A)
 08-0059
 23 cm, 9"



0,5 mm (A)
 08-0225
 20,5 cm 8"



0,5 mm (A)
 08-0227
 23 cm, 9"



0,2 mm (A)
 08-0087
 23 cm, 9"



RYDER-VASCULAR
 08-0080
 - 08-0087



RYDER
 08-0051
 - 08-0059



FRENCH EYE
 08-0221
 - 08-0227

TITE GRIP® Nadelhalter für Linkshänder mit Hartmetalleinlagen
 TITE GRIP® Needle Holders for Left-Hander with tungsten carbide inserts
 TITE GRIP® Porta-agujas para zurdos con bocas de carburo tungsteno
 TITE GRIP® Porte-aiguilles pour gauchers avec mors en tungstène
 TITE GRIP® Portaghi per mancini con morsi in carburo di tungsteno

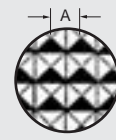

Riefung
 Serration
 Estriadura
 Structure
 Struttura



HALSEY
 08-2011
 13 cm, 5 1/8"



CRILE-WOOD
 08-2065
 15 cm, 6"



CRILE-WOOD
 08-2068
 18 cm, 7"



MAYO-HEGAR
 08-2181
 16 cm, 6 1/4"



MAYO-HEGAR
 08-2183
 18,5 cm, 7 1/4"



TITE GRIP® Nadelhalter mit Hartmetalleinlagen
 TITE GRIP® Needle Holders with tungsten carbide inserts
 TITE GRIP® Porta-agujas con bocas de carburo tungsteno
 TITE GRIP® Porte-aiguilles avec mors en tungstène
 TITE GRIP® Portaghi con morsi in carburo di tungsteno

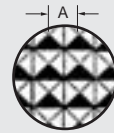

Riefung
 Serration
 Estradadura
 Structure
 Strutturata

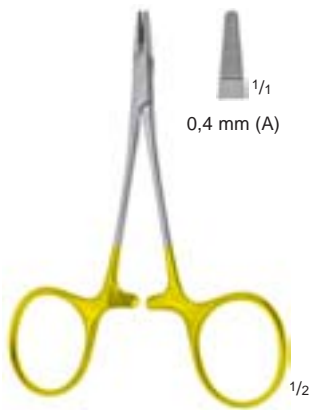

1/1
 0,4 mm (A)

CONVERSE
 08-0027
 10,5 cm, 4 1/8"

mit großen Ringen
 with big sized rings
 con anillos grandes
 à gros anneaux
 con anelli grandi

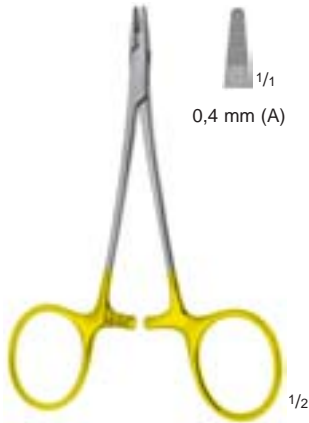

1/1
 0,4 mm (A)

DERF
 08-0015
 11 cm, 4 3/8"

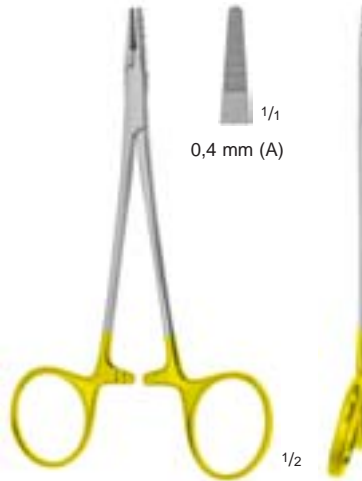

1/1
 0,4 mm (A)

NEIVERT
 08-0025
 12,5 cm, 5"

mit aufgebogenem Daumenring
 with offset ring
 con anillo acodado
 à anneau décalé
 con anelli sfalsati



1/1
 0,4 mm (A)

HALSEY
 08-0011
 - 08-0012

► 08-0012
 13 cm, 5 1/8"

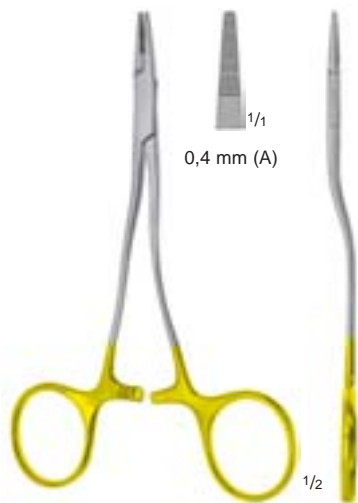
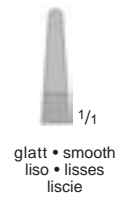

1/1
 0,4 mm (A)

KILNER
 08-0022
 13 cm, 5 1/8"



1/1
 glatt
 smooth
 liso
 lisses
 liscie

WEBSTER
 08-0013
 13 cm, 5 1/8"

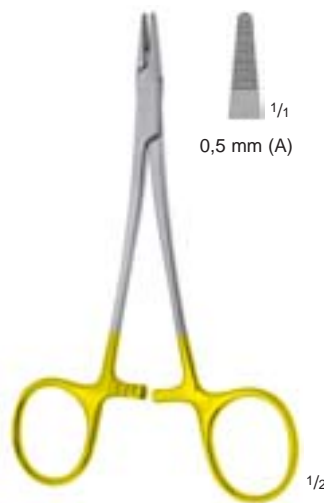

1/1
 0,5 mm (A)

BAUMGARTNER
 08-0017
 13 cm, 5 1/8"



1/1
 0,5 mm (A)



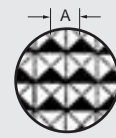

HEGAR-BAUMGARTNER
 08-0021
 14 cm, 5 1/2"

TITE GRIP® Nadelhalter mit Hartmetalleinlagen
 TITE GRIP® Needle Holders with tungsten carbide inserts
 TITE GRIP® Porta-agujas con bocas de carburo tungsteno
 TITE GRIP® Porte-aiguilles avec mors en tungstène
 TITE GRIP® Portaghi con morsi in carburo di tungsteno









Riefung
 Serration
 Estriadura
 Structure
 Struttura



| | | | | |
|---|---|---|---|---|
|  |  |  |  |  |
| 1/1 | 1/1 | 1/1 | 1/1 | 1/1 |
| glatt • smooth liso • lisses liscie | 0,4 mm (A) | 0,4 mm (A) | 0,4 mm (A) | 0,4 mm (A) |
| 08-0066 15 cm, 6" | 08-0065 15 cm, 6" | ▶ 08-0068 18 cm, 7" | 08-0072 20,5 cm, 8" | 08-0076 23 cm, 9" |

CRILE-WOOD
 08-0065
 - 08-0076

| | | | | | |
|---|---|---|---|---|---|
|  |  |  |  |  |  |
| 1/1 | 1/1 | 1/1 | 1/1 | 1/1 | 1/1 |
| 0,4 mm (A) | 0,4 mm (A) | 0,4 mm (A) | 0,4 mm (A) | 0,5 mm (A) | 0,5 mm (A) |
| 08-0054 15 cm, 6" | ▶ 08-0100 18 cm, 7" | 08-0056 20,5 cm, 8" | 08-0101 23 cm, 9" | 08-0102 26,5 cm, 10 1/2" | 08-0103 30,5 cm, 12" |

DE-BAKEY
 08-0054
 - 08-0103



TITE GRIP® Nadelhalter mit Hartmetalleinlagen
 TITE GRIP® Needle Holders with tungsten carbide inserts
 TITE GRIP® Porta-agujas con bocas de carburo tungsteno
 TITE GRIP® Porte-aiguilles avec mors en tungstène
 TITE GRIP® Portaghi con morsi in carburo di tungsteno

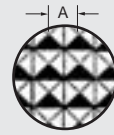

Riefung
 Serration
 Estradadura
 Structure
 Struttura



glatt • smooth
 liso • lisses
 lisce

1/1

glatt • smooth
 liso • lisses
 lisce

1/1

glatt • smooth
 liso • lisses
 lisce

1/1

08-0073 15 cm, 6"
 ▶ 08-0074 17,5 cm, 7"
 08-0077 20 cm, 8"

EUFRATE PASQUE
 08-0073
 - 08-0077



0,2 mm (A)

1/1

0,2 mm (A)

1/1

0,2 mm (A)

1/1

08-0158 15 cm, 6"
 ▶ 08-0159 17,5 cm, 7"
 08-0160 20 cm, 8"

EUFRATE PASQUE
 08-0158
 - 08-0160



1/1

0,4 mm (A)

SAROT
 08-0247
 18 cm, 7"



1/1

0,4 mm (A)

CARROLL
 08-0173
 16 cm, 6 1/4"



1/1

0,5 mm (A)

NEW ORLEANS
 08-0175
 17,5 cm, 7"

TITE GRIP® Nadelhalter mit Hartmetalleinlagen
 TITE GRIP® Needle Holders with tungsten carbide inserts
 TITE GRIP® Porta-agujas con bocas de carburo tungsteno
 TITE GRIP® Porte-aiguilles avec mors en tungstène
 TITE GRIP® Portaghi con morsi in carburo di tungsteno

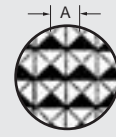

Riefung
 Serration
 Estriadura
 Structure
 Struttura

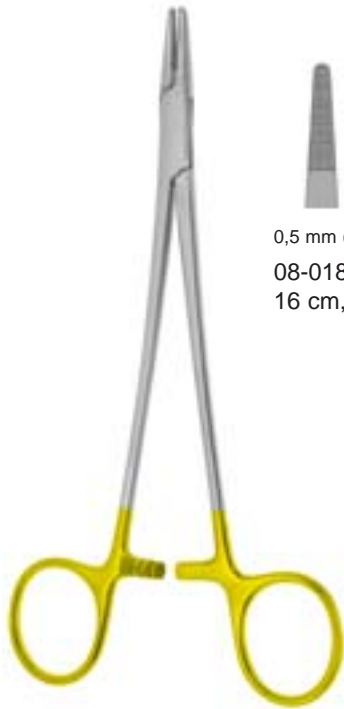

MAYO-HEGAR
 08-0181
 - 08-0197

| | | | | |
|---------------|-----------------|-------------|---------------|----------------|
| | | | | |
| 0,5 mm (A) | 0,5 mm (A) | 0,5 mm (A) | 0,5 mm (A) | 0,5 mm (A) |
| 08-0181 | ▶ 08-0183 | 08-0185 | 08-0195 | 08-0197 |
| 16 cm, 6 1/4" | 18,5 cm, 7 1/4" | 20,5 cm, 8" | 24 cm, 9 1/2" | 27 cm, 10 3/4" |

leichte Modelle • light patterns • modelos ligeros • modèles légers • modelli leggeri

1/2



MAYO-HEGAR
 08-0179
 - 08-0198

| | | | | | | |
|---------------|-----------------|-------------|---------------|----------------|--------------|----------------|
| | | | | | | |
| 0,5 mm (A) | 0,5 mm (A) | 0,5 mm (A) | 0,5 mm (A) | 0,5 mm (A) | 0,5 mm (A) | 0,5 mm (A) |
| 08-0179 | ▶ 08-0186 | 08-0187 | 08-0188 | 08-0196 | 08-0189 | 08-0198 |
| 16 cm, 6 1/4" | 18,5 cm, 7 1/4" | 20,5 cm, 8" | 24 cm, 9 1/2" | 27 cm, 10 3/4" | 30,5 cm, 12" | 37 cm, 14 1/2" |

kräftige Modelle • heavy patterns • modelos robustos • modèles forts • modelli robusti

1/2



TITE GRIP® Nadelhalter mit Hartmetalleinlagen
 TITE GRIP® Needle Holders with tungsten carbide inserts
 TITE GRIP® Porta-agujas con bocas de carburo tungsteno
 TITE GRIP® Porte-aiguilles avec mors en tungstène
 TITE GRIP® Portaghi con morsi in carburo di tungsteno

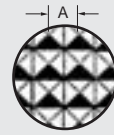

Riefung
 Serration
 Estradatura
 Structure
 Struttura

0,5 mm (A) ^{1/1}
 ▶ 08-0287
 20,5 cm, 8"

0,5 mm (A) ^{1/1}
 08-0288
 26,5 cm, 10 1/2"

HEANEY
 08-0287
 - 08-0288

0,5 mm (A) ^{1/1}
 ▶ 08-0255
 20,5 cm, 8"

0,5 mm (A) ^{1/1}
 08-0257
 26,5 cm, 10 1/2"

FINOCHIETTO
 08-0255
 - 08-0257

0,5 mm (A) ^{1/1}
 ▶ 08-0230
 20 cm, 8"

0,5 mm (A) ^{1/1}
 08-0231
 24 cm, 9 1/2"

0,5 mm (A) ^{1/1}
 08-0232
 26 cm, 10 1/4"

BOZEMANN (WERTHEIM)
 08-0230
 - 08-0232

TITE GRIP® Nadelhalter mit Hartmetalleinlagen
 TITE GRIP® Needle Holders with tungsten carbide inserts
 TITE GRIP® Porta-agujas con bocas de carburo tungsteno
 TITE GRIP® Porte-aiguilles avec mors en tungstène
 TITE GRIP® Portaghi con morsi in carburo di tungsteno

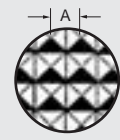

Riefung
 Serration
 Estriadura
 Structure
 Struttura



$\frac{1}{1}$
 0,5 mm (A)

STRATTE
 08-0263
 22,5 cm, 9"

$\frac{1}{2}$

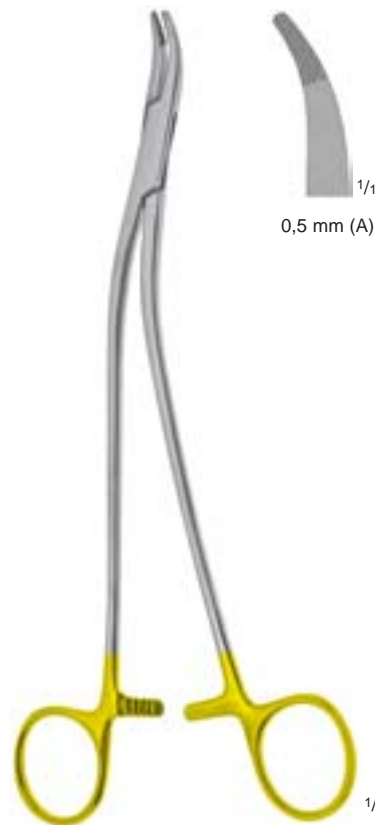

$\frac{1}{1}$
 0,5 mm (A)

STRATTE
 08-0261
 22,5 cm, 9"

$\frac{1}{2}$



$\frac{1}{1}$
 0,5 mm (A)

MASSON
 08-0241
 26,5 cm, 10 $\frac{1}{2}$ "

$\frac{1}{2}$



$\frac{1}{1}$
 0,5 mm (A)

WANGENSTEEN
 08-0245
 27 cm, 10 $\frac{3}{4}$ "

$\frac{1}{2}$



TITE GRIP® Nadelhalter mit Schere
 TITE GRIP® Needle Holders with scissors
 TITE GRIP® Porta-agujas con tijera
 TITE GRIP® Porte-aiguilles avec ciseaux
 TITE GRIP® Portaghi con forbici

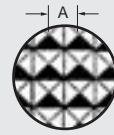

Riefung
 Serration
 Estradadura
 Structure
 Strutturatura



BABY-OLSEN-HEGAR
 08-0111
 12 cm, 4 3/4"



OLSEN-HEGAR
 08-0113
 13,5 cm, 5 1/4"



OLSEN-HEGAR
 08-0115
 17 cm, 6 3/4"



OLSEN-HEGAR
 08-0117
 18,5 cm, 7 1/4"



BABY-GILLIES
 08-0132
 15 cm, 6"



GILLIES
 08-0118
 15,5 cm, 6"



GILLIES
 08-0119
 15,5 cm, 6"



GILLIES
 08-0144
 15,5 cm, 6"

TITE GRIP® Nadelhalter mit Hartmetalleinlagen
 TITE GRIP® Needle Holders with tungsten carbide inserts
 TITE GRIP® Porta-agujas con bocas de carburo tungsteno
 TITE GRIP® Porte-aiguilles avec mors en tungstène
 TITE GRIP® Portaghi con morsi in carburo di tungsteno

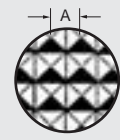

Riefung
 Serration
 Estriadura
 Structure
 Struttura



0,5 mm (A) 1/1
 08-0127 14 cm, 5 1/2"

0,5 mm (A) 1/1
 08-0128 17,5 cm, 7"

0,5 mm (A) 1/1
 08-0129 20 cm, 8"

0,5 mm (A) 1/1
 08-0124 24 cm, 9 1/2"

1/2

MATHIEU
 08-0124
 - 08-0129

0,4 mm (A) 1/1

elastisches Modell
 elastic pattern
 modelo elástico
 modèle souple
 modello elastico

1/2

LAWTON-MATHIEU
 08-0190
 16 cm, 6 1/4"

0,4 mm (A) 1/1

elastisches Modell
 elastic pattern
 modelo elástico
 modèle souple
 modello elastico

1/2

LICHTENBERG
 08-0136
 20 cm, 8"

0,5 mm (A) 1/1

1/2

ZWEIFEL
 08-0145
 20 cm, 8"

0,5 mm (A) 1/1

1/2

LAWTON
 08-0147
 20 cm, 8"



TITE GRIP® Nadelhalter mit Hartmetalleinlagen
 TITE GRIP® Needle Holders with tungsten carbide inserts
 TITE GRIP® Porta-agujas con bocas de carburo tungsteno
 TITE GRIP® Porte-aiguilles avec mors en tungstène
 TITE GRIP® Portaghi con morsi in carburo di tungsteno

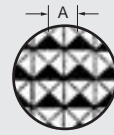

Riefung
 Serration
 Estradatura
 Structure
 Struttura

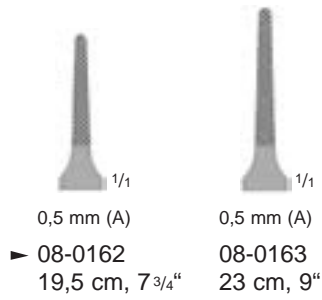

LANGENBECK-RYDER
 08-0162
 - 08-0163

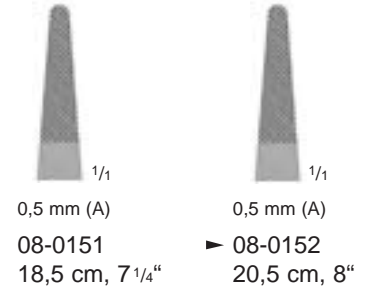

LANGENBECK
 08-0151
 - 08-0152

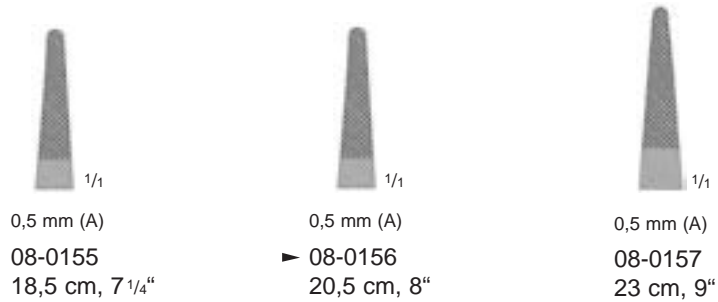

TOENNIS
 08-0155
 - 08-0157

elastische Modelle • elastic patterns • modelos elásticos • modèles souples • modelli elastico



LAWNTON
Medizintechnik

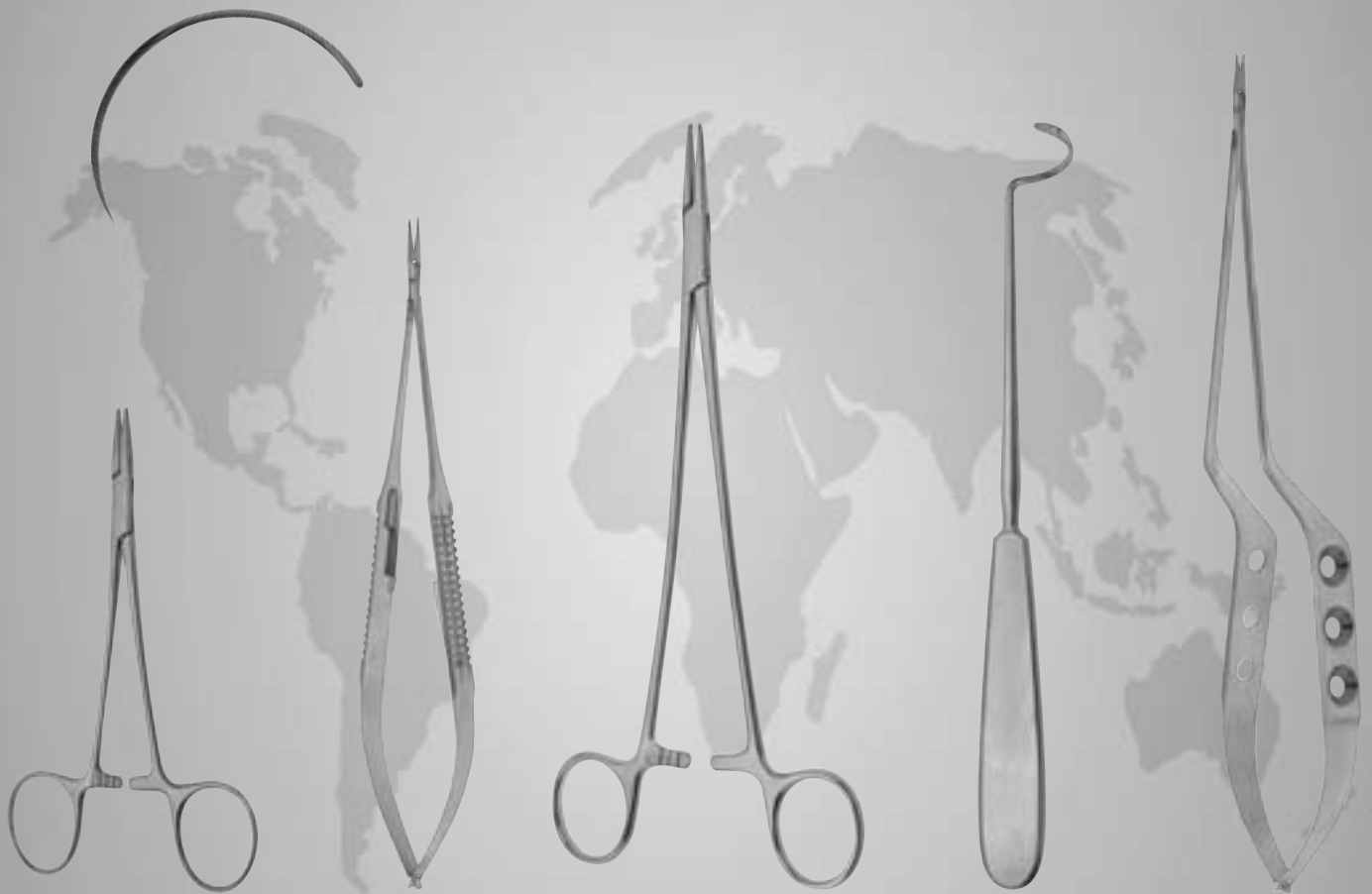

Nahtinstrumente
Suture Instruments
Instrumentos para sutura
Instruments à suture
Strumenti per sutura

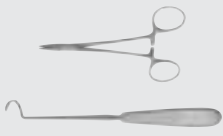

Ligaturscheren, Fadenscheren
 Ligature Scissors
 Tijeras para ligaduras
 Ciseaux à ligatures
 Forbici per legature

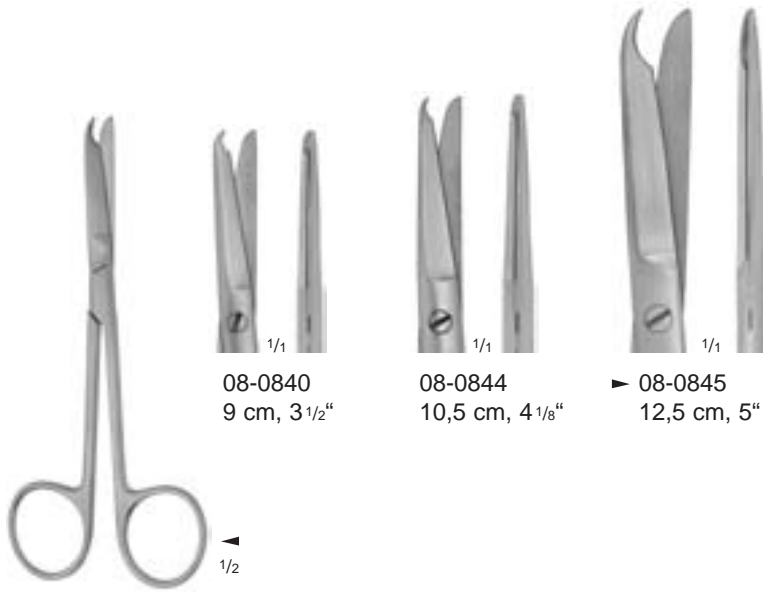

08-0840
9 cm, 3 1/2"

08-0844
10,5 cm, 4 1/8"

▶ 08-0845
12,5 cm, 5"

SPENCER
08-0840
- 08-0845



08-0847
9 cm, 3 1/2"

▶ 08-0846
12,5 cm, 5"

SPENCER (NORTHBENT)
08-0846
- 08-0847

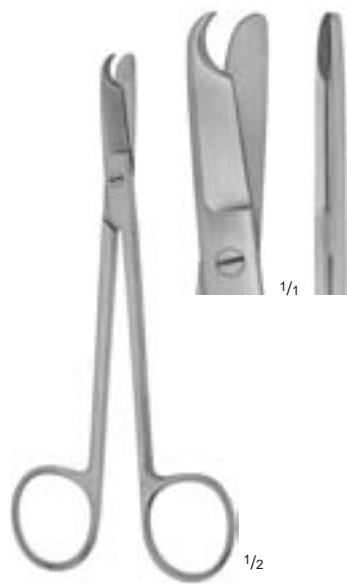

LITTAUER
08-0875
14 cm, 5 1/2"



O'BRIEN
08-0848
9,5 cm, 3 3/4"



EISELSBERG
08-0850
11,5 cm, 4 1/2"

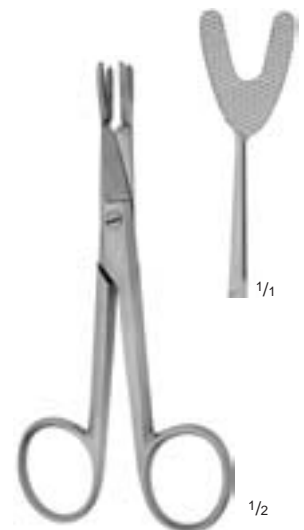

SCHOEMAKER-LOTH
08-0851
12,5 cm, 5"

Ligaturscheren mit Hartmetallschneiden
 Ligature Scissors with tungsten carbide edges
 Tijeras para ligaduras con filos de carburo tungsteno
 Ciseaux à ligatures avec des lames en tungstène
 Forbici per legature con lame in carburo di tungsteno

Nähmaterial
 Suture Material
 Material para sutura
 Matériel à suture
 Suture

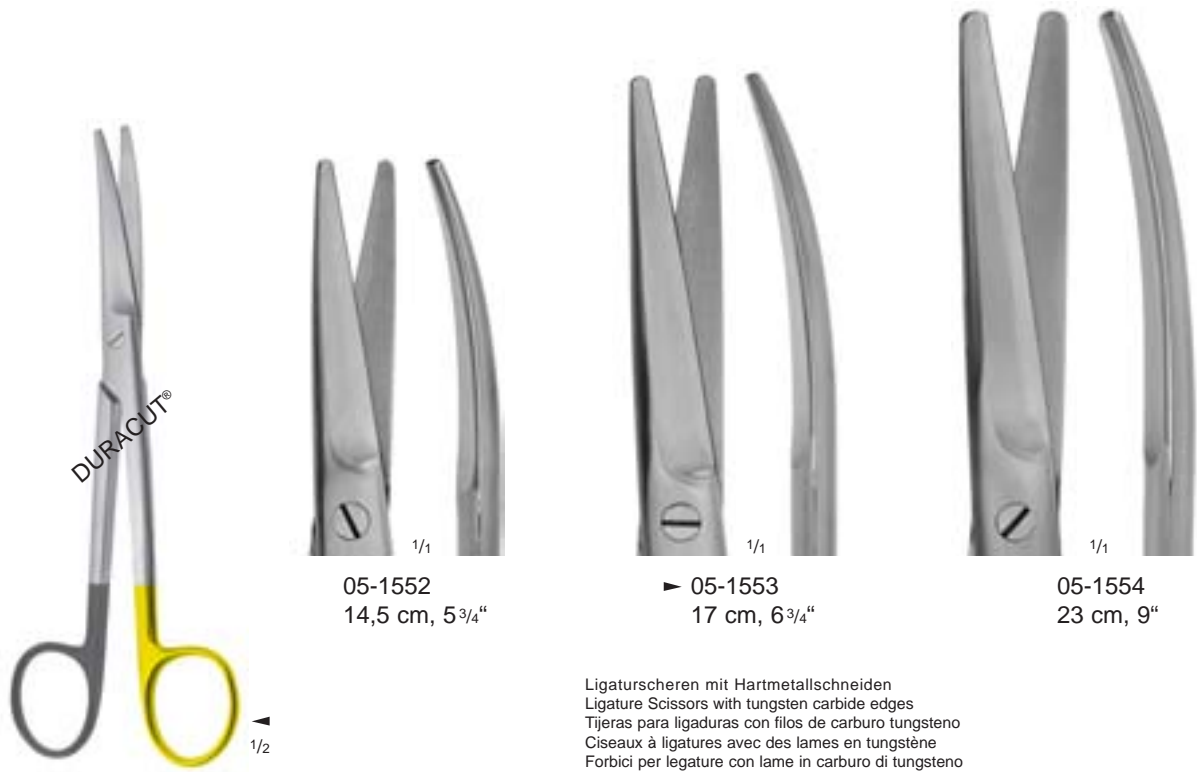
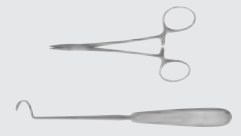

05-1552
 - 05-1554

05-1552
 14,5 cm, 5³/₄"

▶ 05-1553
 17 cm, 6³/₄"

05-1554
 23 cm, 9"

Ligaturscheren mit Hartmetallschneiden
 Ligature Scissors with tungsten carbide edges
 Tijeras para ligaduras con filos de carburo tungsteno
 Ciseaux à ligatures avec des lames en tungstène
 Forbici per legature con lame in carburo di tungsteno



08-1665
 Stärke/No. 2

Catgut, Strang zu 2,5 m, steril, in Glasflacon
 Catgut, hank of 2.5 meters, sterilized, in glass flacon
 Catgut, madeja de 2,5 m, estéril, en frasquito de vidrio
 Catgut, fil de 2,5 mètres, stérile en flacon verre
 Catgut da 2,5 m sterilizzabile in flacon vetro



08-1669 Stärke/No. 0
 ▶ 08-1670 Stärke/No. 1
 08-1671 Stärke/No. 2

Nähseide, gedreht, Strang zu 0,5 g., steril, in Glasflacon
 Suture silk, twisted, hank of 0.5 gramme, sterilized, in glass flacon
 Seda para sutura, hilado, madeja de 0,5 gr., estéril, en frasquito de vidrio
 Soie à suture, torsadée, fil de 0,5 gramme, stérile en flacon verre
 Seta intrecciata 0,5 gr. sterilizzabile in flacon vetro

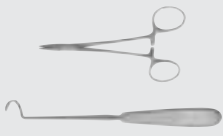

Chirurgische Nähnadeln
Surgical Suture Needles
Agujas quirúrgicas para sutura
Aiguilles à sutures
Aghi chirurgici per sutura

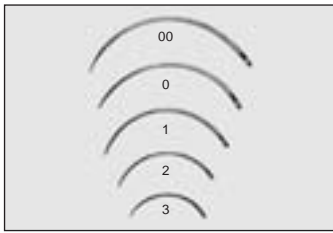

1/1



KALT

- 08-1489 Fig. 00
- 08-1490 Fig. 0
- 08-1491 Fig. 1
- 08-1492 Fig. 2
- 08-1493 Fig. 3

Gefäßnadeln, gebogen $\frac{3}{8}$ Kreis,
in Packungen zu 12 Stück

Vascular suture needles, curved
 $\frac{3}{8}$ circle, in packages of 12 pieces

Agujas vasculares, curvas $\frac{3}{8}$
círculo, cajecita de 12 piezas

Aiguilles vasculaires, $\frac{3}{8}$ de cercle,
paquet de 12.

Aghi per sutura vascolare curvi $\frac{3}{8}$ di
cerchio, in confezione da 12 pz.

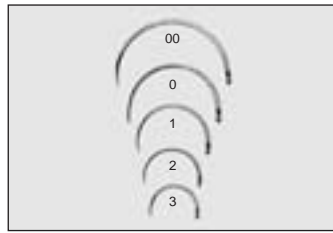

1/1



PAYR

- 08-1509 Fig. 00
- 08-1510 Fig. 0
- 08-1511 Fig. 1
- 08-1512 Fig. 2
- 08-1513 Fig. 3

Gefäßnadeln, gebogen $\frac{1}{2}$ Kreis,
in Packungen zu 12 Stück

Vascular suture needles, curved
 $\frac{1}{2}$ circle, in packages of 12 pieces

Agujas vasculares, curvas $\frac{1}{2}$
círculo, cajecita de 12 piezas

Aiguilles vasculaires, $\frac{1}{2}$ de cercle,
paquet de 12.

Aghi per sutura vascolare curvi $\frac{1}{2}$ di
cerchio, in confezione da 12 pz.

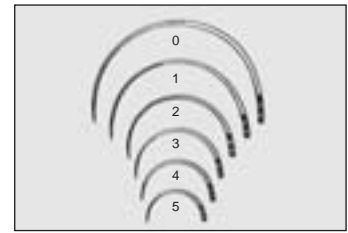

1/1



Og

- 08-1410 Fig. 0
- 08-1411 Fig. 1
- 08-1412 Fig. 2
- 08-1413 Fig. 3
- 08-1414 Fig. 4
- 08-1415 Fig. 5

Augennadeln, gebogen $\frac{1}{2}$ Kreis,
in Packungen zu 12 Stück

Eye needles, curved $\frac{1}{2}$ circle,
in packages of 12 pieces

Agujas para suturas oculares, curvas $\frac{1}{2}$
círculo, cajecita de 12 piezas

Aiguilles pour ophtalmologie, $\frac{1}{2}$ de
cercle, paquet de 12.

Aghi per oftalmologia, curvi $\frac{1}{2}$ di
cerchio, in confezione da 12 pz.

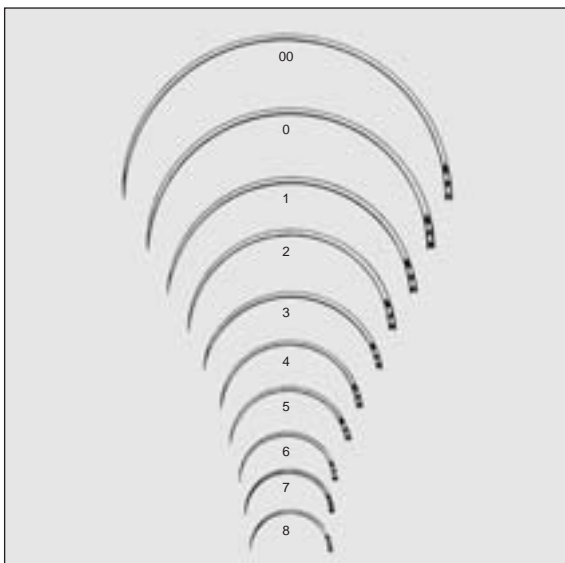

1/1



Pb

- 08-1309 Fig. 00
- 08-1310 Fig. 0
- 08-1311 Fig. 1
- 08-1312 Fig. 2
- 08-1313 Fig. 3
- 08-1314 Fig. 4
- 08-1315 Fig. 5
- 08-1316 Fig. 6
- 08-1317 Fig. 7
- 08-1318 Fig. 8

Darmnadeln, gebogen $\frac{1}{2}$ Kreis,
in Packungen zu 12 Stück

Intestinal needles, curved $\frac{1}{2}$
circle, in packages of 12 pieces

Agujas para suturas intestinales, curvas
 $\frac{1}{2}$ círculo, cajecita de 12 piezas

Aiguilles intestinales, $\frac{1}{2}$ de cercle,
paquet de 12.

Aghi per sutura intestinale curvi $\frac{1}{2}$ di
cerchio, in confezione da 12 pz.

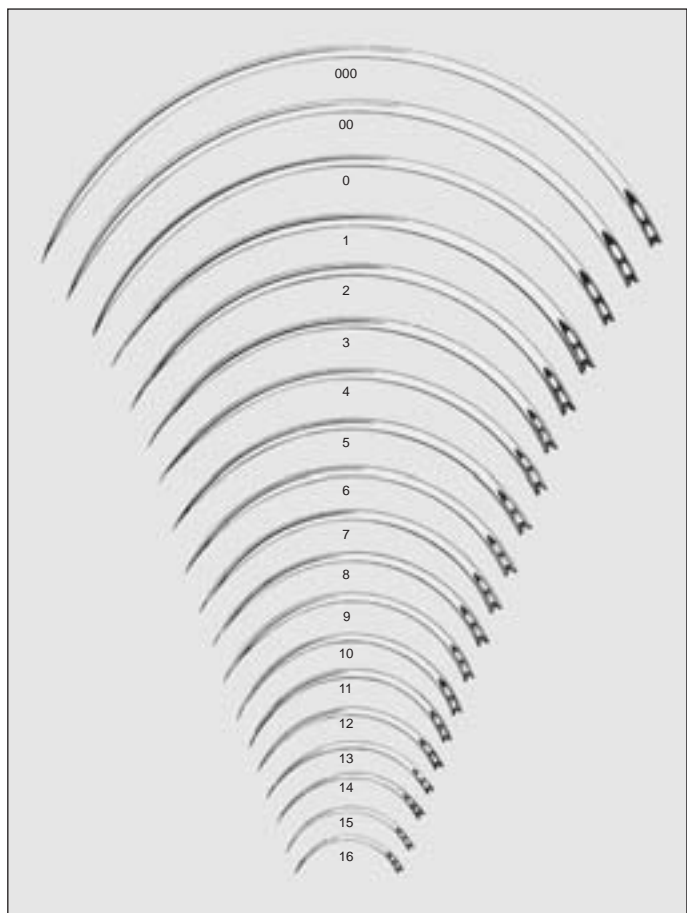
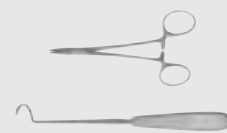

1/1



- B**
- 08-1198 Fig. 000
 - 08-1199 Fig. 00
 - 08-1200 Fig. 0
 - 08-1201 Fig. 1
 - 08-1202 Fig. 2
 - 08-1203 Fig. 3
 - 08-1204 Fig. 4
 - 08-1205 Fig. 5
 - 08-1206 Fig. 6
 - 08-1207 Fig. 7
 - 08-1208 Fig. 8
 - 08-1209 Fig. 9
 - 08-1210 Fig. 10
 - 08-1211 Fig. 11
 - 08-1212 Fig. 12
 - 08-1213 Fig. 13
 - 08-1214 Fig. 14
 - 08-1215 Fig. 15
 - 08-1216 Fig. 16

gebogen $\frac{3}{8}$ Kreis, in Packungen zu 12 Stück
 curved $\frac{3}{8}$ circle, in packages of 12 pieces
 curvas $\frac{3}{8}$ círculo, cajecita de 12 piezas
 courbure $\frac{3}{8}$ cercle, paquet de 12
 curvi $\frac{3}{8}$ di cerchio, in confezione da 12 pz.

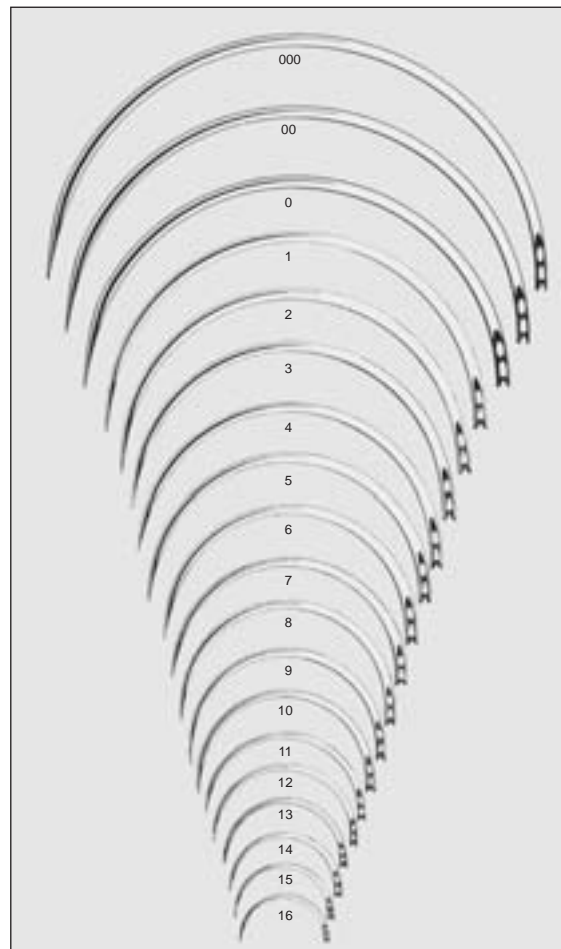

1/1



- G**
- 08-1218 Fig. 000
 - 08-1219 Fig. 00
 - 08-1220 Fig. 0
 - 08-1221 Fig. 1
 - 08-1222 Fig. 2
 - 08-1223 Fig. 3
 - 08-1224 Fig. 4
 - 08-1225 Fig. 5
 - 08-1226 Fig. 6
 - 08-1227 Fig. 7
 - 08-1228 Fig. 8
 - 08-1229 Fig. 9
 - 08-1230 Fig. 10
 - 08-1231 Fig. 11
 - 08-1232 Fig. 12
 - 08-1233 Fig. 13
 - 08-1234 Fig. 14
 - 08-1235 Fig. 15
 - 08-1236 Fig. 16

gebogen $\frac{1}{2}$ Kreis, in Packungen zu 12 Stück
 curved $\frac{1}{2}$ circle, in packages of 12 pieces
 curvas $\frac{1}{2}$ círculo, cajecita de 12 piezas
 courbure $\frac{1}{2}$ cercle, paquet de 12
 curvi $\frac{1}{2}$ di cerchio, in confezione da 12 pz.

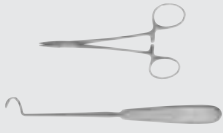

Chirurgische Nähnadeln
 Surgical Suture Needles
 Aguja quirúrgicas para sutura
 Aiguilles à sutures
 Aghi chirurgici per sutura

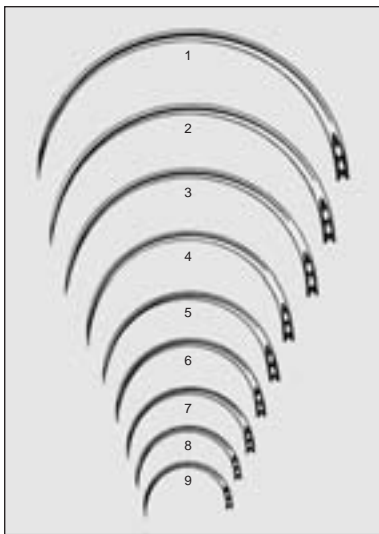

1/1



Ga

- 08-1131 Fig. 1
- 08-1132 Fig. 2
- 08-1133 Fig. 3
- 08-1134 Fig. 4
- 08-1135 Fig. 5
- 08-1136 Fig. 6
- 08-1137 Fig. 7
- 08-1138 Fig. 8
- 08-1139 Fig. 9

gebogen 1/2 Kreis, in Packungen zu 12 Stück
 curved 1/2 circle, in packages of 12 pieces
 curvas 1/2 círculo, cajecita de 12 piezas
 courbure 1/2 cercle, paquet de 12
 curvi 1/2 di cerchio, in confezione da 12 pz.

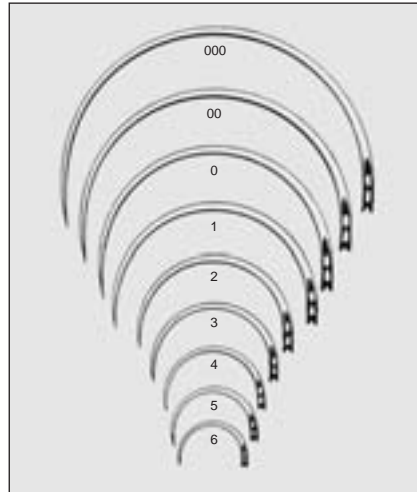

1/1



E

- 08-1258 Fig. 000
- 08-1259 Fig. 00
- 08-1260 Fig. 0
- 08-1261 Fig. 1
- 08-1262 Fig. 2
- 08-1263 Fig. 3
- 08-1264 Fig. 4
- 08-1265 Fig. 5
- 08-1266 Fig. 6

gebogen 1/2 Kreis, in Packungen zu 12 Stück
 curved 1/2 circle, in packages of 12 pieces
 curvas 1/2 círculo, cajecita de 12 piezas
 courbure 1/2 cercle, paquet de 12
 curvi 1/2 di cerchio, in confezione da 12 pz.

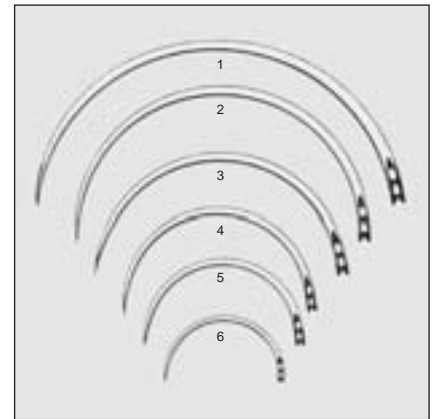

1/1



FERGUSON

- 08-1341 Fig. 1
- 08-1342 Fig. 2
- 08-1343 Fig. 3
- 08-1344 Fig. 4
- 08-1345 Fig. 5
- 08-1346 Fig. 6

gebogen 1/2 Kreis, in Packungen zu 12 Stück
 curved 1/2 circle, in packages of 12 pieces
 curvas 1/2 círculo, cajecita de 12 piezas
 courbure 1/2 cercle, paquet de 12
 curvi 1/2 di cerchio, in confezione da 12 pz.

Weitere chirurgische Nähnadeln auf Anfrage lieferbar !
 Further surgical suture needles can be delivered on request !
 Más agujas quirúrgicas para sutura entregables según demanda !
 Autres aiguilles à sutures livrées sur commandes !
 Altri aghi chirurgici per sutura possono essere ordinati su richiesta !

Nadel-Sterilisierdosen
 Needle Sterilizing Boxes
 Estuches para esterilizar agujas
 Boîtes pour stériliser des aiguilles de suture
 Scatole per sterilizzare aghi da sutura

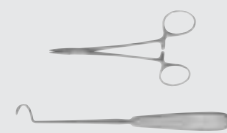

- 08-1660 50 x 25 x 4,5 mm
- 08-1659 65 x 42 x 8,0 mm
- ▶ 08-1662 77 x 25 x 5,5 mm



- 08-1641
- 150 x 95 x 13 mm



- SAUERBRUCH
- 08-1643
- 210 x 125 x 17 mm



- SAUERBRUCH
- 08-1644
- 210 x 125 x 17 mm



- ▶ 08-1650
- 65 x 15 mm
- Außen- und Innendose
- Exterior and interior box
- Caja exterior e interior
- Boîte extérieure et intérieure
- Scatola esterna ed interiore

- 08-1651
- 62 x 13 mm
- Innendose allein
- Interior box only
- Caja interior, suelta
- Boîte intérieure seule
- Scatola interiore sola

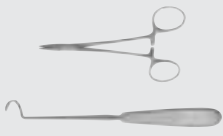

Mikro-Nadelhalter mit flachen Federgriffen
Micro Needle Holders with flat spring type handles
Micro-Porta-agujas con mangos de resortes planos
Micro porte-aiguilles avec manches à ressorts plats
Micro portaghi con manici a molla piatta



PERFECT-GRIP Nadelhalter mit spezialbeschichteten Maulteilen garantieren ein rutschesicheres und schonendes Fassen von feinsten Wundnadeln und Nahtmaterial (siehe Seiten 359, 361-362, 364-365).

PERFECT-GRIP Needle holders with specially coated jaws ensure a non-slip and gentle grasping of most delicate wound needles and sutures (see pages 359, 361-362, 364-365).

PERFECT-GRIP Porta-agujas con las bocas cubiertas especiales garantizan un sujeto antideslizante y cuidadoso para agujas de sutura muy finas y materiales de sutura (veán paginas 359, 361-362, 364-365).

PERFECT-GRIP Porte-aiguilles avec les mors recouverts d'une couche spéciale garantissent une excellente préhension des aiguilles à suture les plus fines (voir pages 359, 361-362, 364-365).

PERFECT-GRIP Portaghi con morso rivestito da un materiale speciale che garantisce il non sivolamento e la presa delicata ma sicura anche con le suture più sottili (da vedere pagine 359, 361-362, 364-365).

 1/1
 ▶ 62-3742
 9 cm, 3 1/2"

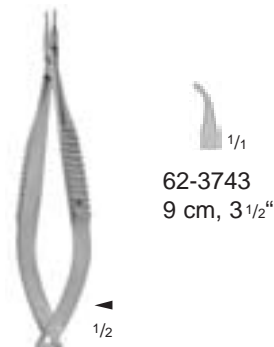



 1/1
 62-3743
 9 cm, 3 1/2"

MICRO-CASTROVIEJO
 62-3742
 - 62-3743

mit glatten Maulteilen / ohne Sperre
 with smooth jaws / without catch
 con bocas lisas / sin cremallera
 avec mors lisses / sans verrou
 con punta liscia / senza cremagliera

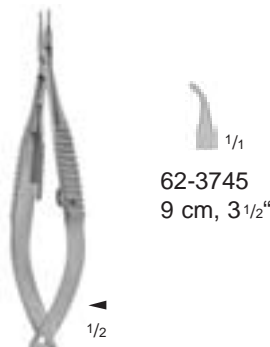
 1/1
 ▶ 62-3744
 9 cm, 3 1/2"





 1/1
 62-3745
 9 cm, 3 1/2"

MICRO-CASTROVIEJO
 62-3744
 - 62-3745

mit glatten Maulteilen / mit Sperre
 with smooth jaws / with catch
 con bocas lisas / con cremallera
 avec mors lisses / à verrou
 con punta liscia / con cremagliera

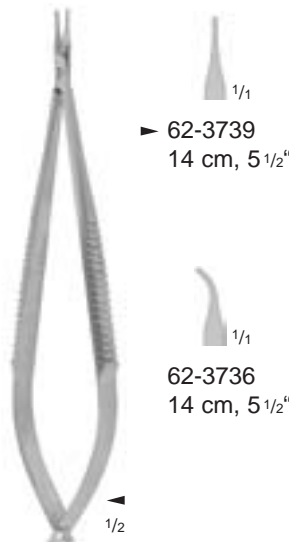
 1/1
 ▶ 62-3739
 14 cm, 5 1/2"



 1/1
 62-3736
 14 cm, 5 1/2"

MICRO-CASTROVIEJO
 62-3736
 - 62-3739

mit glatten Maulteilen / ohne Sperre
 with smooth jaws / without catch
 con bocas lisas / sin cremallera
 avec mors lisses / sans verrou
 con punta liscia / senza cremagliera

 1/1
 ▶ 62-3740
 14 cm, 5 1/2"

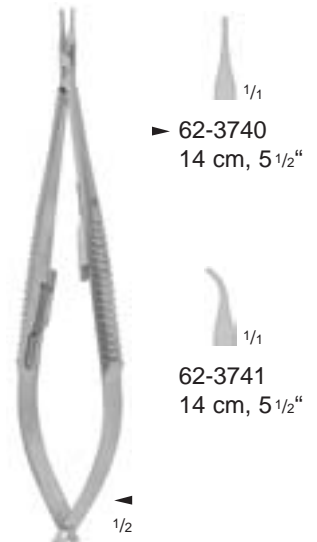

 1/1
 62-3741
 14 cm, 5 1/2"

MICRO-CASTROVIEJO
 62-3740
 - 62-3741

mit glatten Maulteilen / mit Sperre
 with smooth jaws / with catch
 con bocas lisas / con cremallera
 avec mors lisses / à verrou
 con punta liscia / con cremagliera

Mikro-Nadelhalter mit flachen Federgriffen
 Micro Needle Holders with flat spring type handles
 Micro-Porta-agujas con mangos de resortes planos
 Micro porte-aiguilles avec manches à ressorts plats
 Micro portaghi con manici a molla piatta

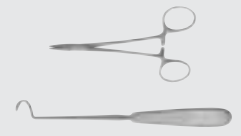

▶ 25-0210
18 cm, 7"

▶ 25-0211
21 cm, 8 1/4"

▶ 25-0212
18 cm, 7"

▶ 25-0213
21 cm, 8 1/4"

mit spezialbeschichteten Maulteilen / ohne Sperre
 with specially coated jaws / without catch
 con bocas cubiertas especiales / sin cremallera
 avec mors recouverts d'une couche spéciale / sans verrou
 con copertura speciale della punta / senza cremagliera

1/2

JACOBSON
 25-0210
 - 25-0213

▶ 25-0216
18 cm, 7"

▶ 25-0217
21 cm, 8 1/4"

▶ 25-0218
18 cm, 7"

▶ 25-0219
21 cm, 8 1/4"

mit spezialbeschichteten Maulteilen / mit Sperre
 with specially coated jaws / with catch
 con bocas cubiertas especiales / con cremallera
 avec mors recouverts d'une couche spéciale / à verrou
 con copertura speciale della punta / con cremagliera

1/2

JACOBSON
 25-0216
 - 25-0219

▶ 25-0320
16 cm, 6 1/4"

▶ 25-0321
18,5 cm, 7 1/4"

▶ 25-0322
16 cm, 6 1/4"

▶ 25-0323
18,5 cm, 7 1/4"

mit spezialbeschichteten Maulteilen / ohne Sperre
 with specially coated jaws / without catch
 con bocas cubiertas especiales / sin cremallera
 avec mors recouverts d'une couche spéciale / sans verrou
 con copertura speciale della punta / senza cremagliera

1/2

25-0320
 - 25-0323

▶ 25-0326
16 cm, 6 1/4"

▶ 25-0327
18,5 cm, 7 1/4"

▶ 25-0328
16 cm, 6 1/4"

▶ 25-0329
18,5 cm, 7 1/4"

mit spezialbeschichteten Maulteilen / mit Sperre
 with specially coated jaws / with catch
 con bocas cubiertas especiales / con cremallera
 avec mors recouverts d'une couche spéciale / à verrou
 con copertura speciale della punta / con cremagliera

1/2

25-0326
 - 25-0329

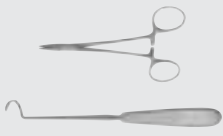

Mikro-Nadelhalter mit runden Federgriffen
Micro Needle Holders with round spring type handles
Micro-Porta-agujas con mangos de resortes redondos
Micro porte-aiguilles avec manches à ressorts ronds
Micro portaghi con manici a molla rotonda



▶ 62-3765
9,5 cm, 3³/₄"

62-3763
9,5 cm, 3³/₄"

BARRAQUER-TROUTMAN
62-3763
- 62-3765

mit glatten Maulteilen / ohne Sperre
 with smooth jaws / without catch
 con bocas lisas / sin cremallera
 avec mors lisses / sans verrou
 con punta liscia / senza cremagliera



▶ 62-3764
9,5 cm, 3³/₄"

62-3762
9,5 cm, 3³/₄"

BARRAQUER-TROUTMAN
62-3762
- 62-3764

mit glatten Maulteilen / mit Sperre
 with smooth jaws / with catch
 con bocas lisas / con cremallera
 avec mors lisses / à verrou
 con punta liscia / con cremagliera



62-3768
11,5 cm, 4¹/₂"

62-3769
13,5 cm, 5¹/₄"

62-3755
11,5 cm, 4¹/₂"

▶ 62-3760
13,5 cm, 5¹/₄"

BARRAQUER
62-3755
- 62-3769

mit glatten Maulteilen / ohne Sperre
 with smooth jaws / without catch
 con bocas lisas / sin cremallera
 avec mors lisses / sans verrou
 con punta liscia / senza cremagliera



62-3778
11,5 cm, 4¹/₂"

62-3779
13,5 cm, 5¹/₄"

62-3756
11,5 cm, 4¹/₂"

▶ 62-3761
13,5 cm, 5¹/₄"







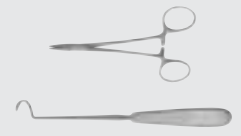



BARRAQUER
62-3756
- 62-3779

mit glatten Maulteilen / mit Sperre
 with smooth jaws / with catch
 con bocas lisas / con cremallera
 avec mors lisses / à verrou
 con punta liscia / con cremagliera

Mikro-Nadelhalter mit runden Federgriffen
 Micro Needle Holders with round spring type handles
 Micro-Porta-agujas con mangos de resortes redondos
 Micro porte-aiguilles avec manches à ressorts ronds
 Micro portaghi con manici a molla rotonda













25-0420
 - 25-0429

| | | | | |
|---|---|---|---|---|
|  |  |  |  |  |
| 25-0420 12 cm, 4 3/4" | 25-0421 15 cm, 6" | ▶ 25-0422 18 cm, 7" | 25-0423 21 cm, 8 1/4" | 25-0424 23 cm, 9" |
|  |  |  |  |  |
| 25-0425 12 cm, 4 3/4" | 25-0426 15 cm, 6" | 25-0427 18 cm, 7" | 25-0428 21 cm, 8 1/4" | 25-0429 23 cm, 9" |

mit spezialbeschichteten Maulteilen / ohne Sperre
 with specially coated jaws / without catch
 con bocas cubiertas especiales / sin cremallera
 avec mors recouverts d'une couche spéciale / sans verrou
 con copertura speciale della punta / senza cremagliera



25-0430
 - 25-0439

| | | | | |
|---|---|---|---|---|
|  |  |  |  |  |
| 25-0430 12 cm, 4 3/4" | 25-0431 15 cm, 6" | ▶ 25-0432 18 cm, 7" | 25-0433 21 cm, 8 1/4" | 25-0434 23 cm, 9" |
|  |  |  |  |  |
| 25-0435 12 cm, 4 3/4" | 25-0436 15 cm, 6" | 25-0437 18 cm, 7" | 25-0438 21 cm, 8 1/4" | 25-0439 23 cm, 9" |

mit spezialbeschichteten Maulteilen / mit Sperre
 with specially coated jaws / with catch
 con bocas cubiertas especiales / con cremallera
 avec mors recouverts d'une couche spéciale / à verrou
 con copertura speciale della punta / con cremagliera

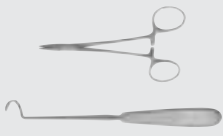

Mikro-Nadelhalter
 Micro Needle Holders
 Micro-Porta-agujas
 Micro porte-aiguilles
 Micro portaghi



| | | |
|----------------------|------------------------|--------------------------|
| | | |
| 25-0461 15 cm, 6" | ▶ 25-0462 18 cm, 7" | 25-0463 21 cm, 8 1/4" |
| | | |
| 25-0466 15 cm, 6" | 25-0467 18 cm, 7" | 25-0468 21 cm, 8 1/4" |

aus TITAN gefertigt, mit spezialbeschichteten Maulteilen / ohne Sperre
 made of TITANIUM, with specially coated jaws / without catch
 fabricados de TITANIO, con bocas cubiertas especiales / sin cremallera
 en TITANE, recouverts d'une couche spéciale / sans verrou
 in TITANIO, con copertura speciale della punta / senza cremagliera

25-0461
- 25-0468



| | | |
|----------------------|------------------------|--------------------------|
| | | |
| 25-0471 15 cm, 6" | ▶ 25-0472 18 cm, 7" | 25-0473 21 cm, 8 1/4" |
| | | |
| 25-0476 15 cm, 6" | 25-0477 18 cm, 7" | 25-0478 21 cm, 8 1/4" |

aus TITAN gefertigt, mit spezialbeschichteten Maulteilen / mit Sperre
 made of TITANIUM, with specially coated jaws / with catch
 fabricados de TITANIO, con bocas cubiertas especiales / con cremallera
 en TITANE, recouverts d'une couche spéciale / à verrou
 in TITANIO, con copertura speciale della punta / con cremagliera

25-0471
- 25-0478



| | |
|------------------------|----------------------|
| | |
| ▶ 57-1095 20 cm, 8" | 57-1096 20 cm, 8" |

YASARGIL
 57-1095
 - 57-1096

mit spezialbeschichteten Maulteilen / ohne Sperre
 with specially coated jaws / without catch
 con bocas cubiertas especiales / sin cremallera
 avec mors recouverts d'une couche spéciale / sans verrou
 con copertura speciale della punta / senza cremagliera



| | | |
|--------------------------|------------------------|----------------------------|
| | | |
| ▶ 57-1097 22,5 cm, 9" | 57-1098 22,5 cm, 9" | 57-1099 24,5 cm, 9 3/4" |

YASARGIL
 57-1097
 - 57-1099

mit spezialbeschichteten Maulteilen / ohne Sperre
 with specially coated jaws / without catch
 con bocas cubiertas especiales / sin cremallera
 avec mors recouverts d'une couche spéciale / sans verrou
 con copertura speciale della punta / con cremagliera

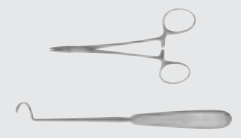

CASTROVIEJO
62-3750
13 cm, 5 1/8"

glattes Maul
smooth jaws
bocas lisas
mors lisses
morso liscio



KALT
08-0036
13,5 cm, 5 1/4"

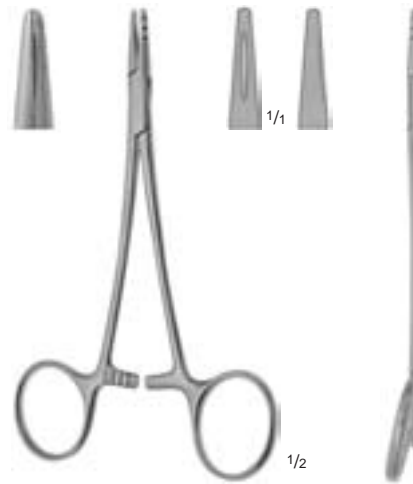

NEIVERT
08-0016
12,5 cm, 5"

glattes Maul mit Spezialkehle
smooth jaws, with special groove
bocas lisas, con acanaladura especial
mors lisses, rainurés
morso liscio con scanalatura speciale



DERF
08-0030
12 cm, 4 3/4"

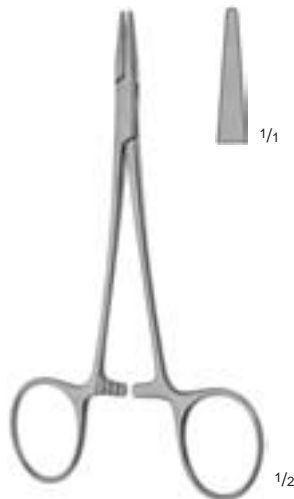

HALSEY
08-0010
13 cm, 5 1/8"

glattes Maul
smooth jaws
bocas lisas
mors lisses
morso liscio

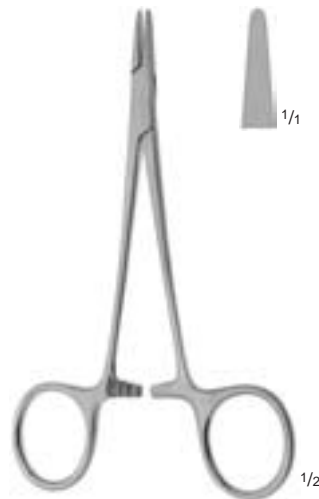

WEBSTER
08-0024
13 cm, 5 1/8"

glattes Maul
smooth jaws
bocas lisas
mors lisses
morso liscio



COLLIER
08-0020
13 cm, 5 1/8"

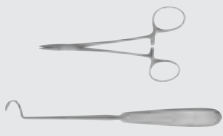

Nadelhalter
Needle Holders
Porta-agujas
Porte-aiguilles
Portaghi

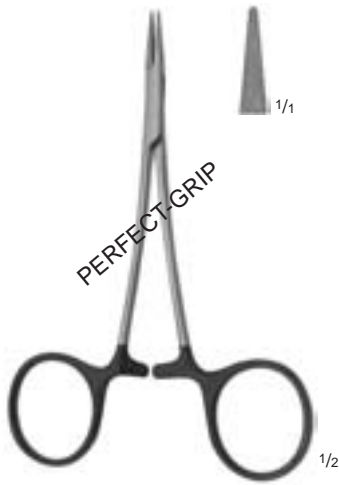

VASCULAR
08-1020
12,5 cm, 5"

mit spezialbeschichteten Maulteilen
with specially coated jaws
con bocas cubiertas especiales
avec mors recouverts d'une couche spéciale
con copertura speciale della punta



VASCULAR
08-1022
14,5 cm, 5³/₄"

mit spezialbeschichteten Maulteilen
with specially coated jaws
con bocas cubiertas especiales
avec mors recouverts d'une couche spéciale
con copertura speciale della punta



VASCULAR
08-1024
17,5 cm, 7"

mit spezialbeschichteten Maulteilen
with specially coated jaws
con bocas cubiertas especiales
avec mors recouverts d'une couche spéciale
con copertura speciale della punta



VASCULAR
08-1026
19,5 cm, 7³/₄"

mit spezialbeschichteten Maulteilen
with specially coated jaws
con bocas cubiertas especiales
avec mors recouverts d'une couche spéciale
con copertura speciale della punta



VASCULAR
08-1028
22,5 cm, 9"

mit spezialbeschichteten Maulteilen
with specially coated jaws
con bocas cubiertas especiales
avec mors recouverts d'une couche spéciale
con copertura speciale della punta

TITAN-LINE Nadelhalter aus TITAN gefertigt
 TITAN-LINE Needle Holders made of TITANIUM
 TITAN-LINE Porta-agujas fabricados de TITANIO
 TITAN-LINE Porte-aiguilles en TITANE
 TITAN-LINE Portaghi in TITANIO

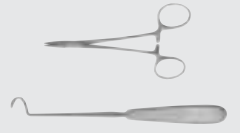

VASCULAR
 08-1030
 12,5 cm, 5"

mit spezialbeschichteten Maulteilen
 with specially coated jaws
 con bocas cubiertas especiales
 avec mors recouverts d'une couche spéciale
 con copertura speciale della punta



VASCULAR
 08-1032
 14,5 cm, 5 3/4"

mit spezialbeschichteten Maulteilen
 with specially coated jaws
 con bocas cubiertas especiales
 avec mors recouverts d'une couche spéciale
 con copertura speciale della punta



VASCULAR
 08-1034
 17,5 cm, 7"

mit spezialbeschichteten Maulteilen
 with specially coated jaws
 con bocas cubiertas especiales
 avec mors recouverts d'une couche spéciale
 con copertura speciale della punta



VASCULAR
 08-1036
 19,5 cm, 7 3/4"

mit spezialbeschichteten Maulteilen
 with specially coated jaws
 con bocas cubiertas especiales
 avec mors recouverts d'une couche spéciale
 con copertura speciale della punta



VASCULAR
 08-1038
 22,5 cm, 9"

mit spezialbeschichteten Maulteilen
 with specially coated jaws
 con bocas cubiertas especiales
 avec mors recouverts d'une couche spéciale
 con copertura speciale della punta

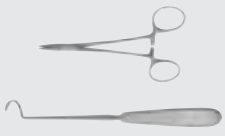

Nadelhalter
Needle Holders
Porta-agujas
Porte-aiguilles
Portaghi



BROWN
78-0320
13 cm, 5 1/8"

mit konvexen Maulteilen
with convex jaws
con bocas convexas
avec mors convexas
con morso diagonale

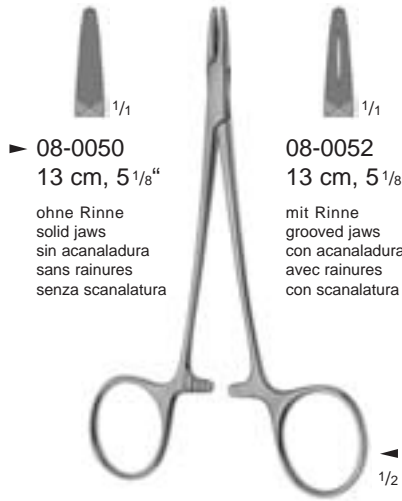

▶ 08-0050
13 cm, 5 1/8"

ohne Rinne
solid jaws
sin acanaladura
sans rainures
senza scanalatura

BAUMGARTNER
08-0050
- 08-0052

leichte Modelle
light patterns
modelos ligeros
modèles légers
modelli leggeri

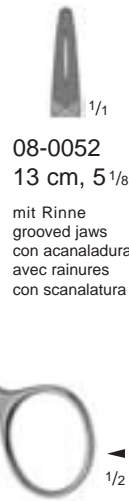

08-0052
13 cm, 5 1/8"

mit Rinne
grooved jaws
con acanaladura
avec rainures
con scanalatura

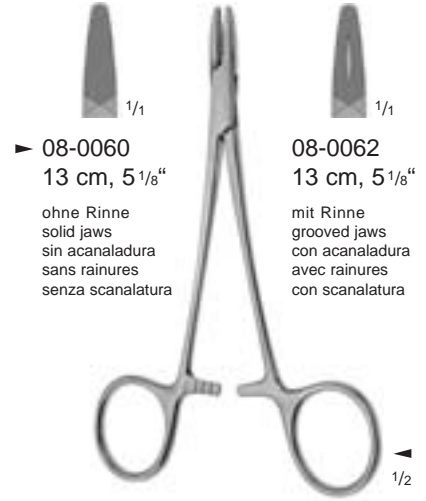

▶ 08-0060
13 cm, 5 1/8"

ohne Rinne
solid jaws
sin acanaladura
sans rainures
senza scanalatura

BAUMGARTNER
08-0060
- 08-0062

kräftige Modelle
heavy patterns
modelos robustos
modèles forts
modelli robusti

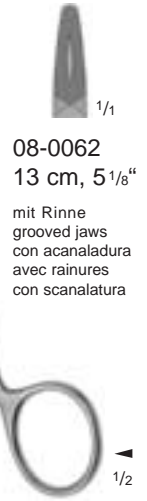

08-0062
13 cm, 5 1/8"

mit Rinne
grooved jaws
con acanaladura
avec rainures
con scanalatura

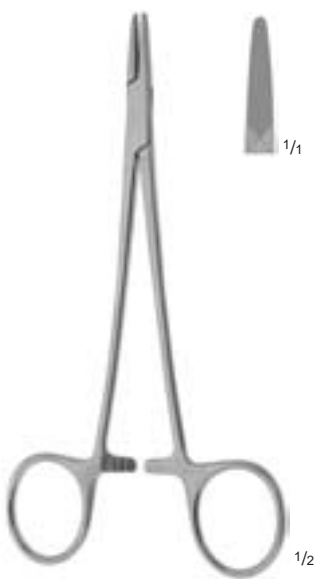

CRILE-MURRAY
08-0014
15 cm, 6"



CRILE-WOOD
08-0064
15 cm, 6"



CARROLL
08-0082
16 cm, 6 1/4"

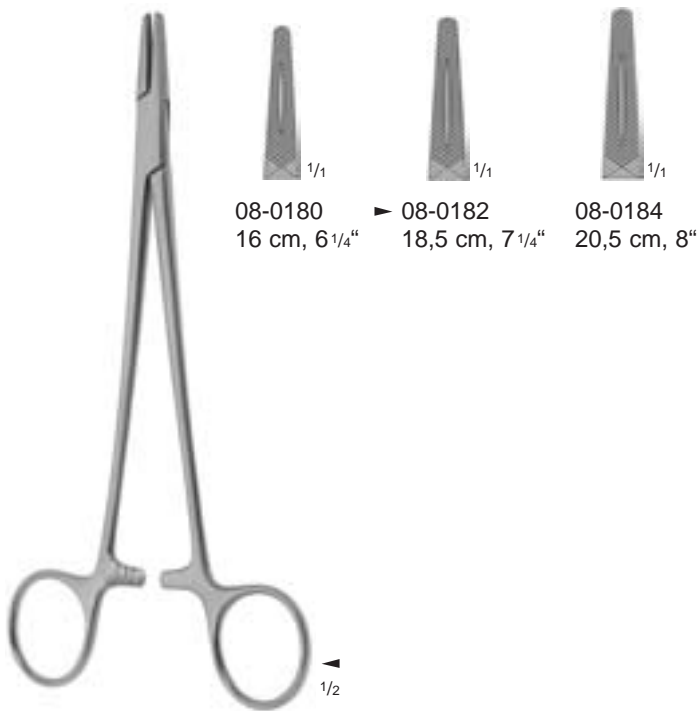
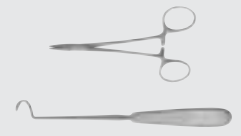

08-0180 16 cm, 6 1/4" ▶ 08-0182 18,5 cm, 7 1/4" 08-0184 20,5 cm, 8"

MAYO-HEGAR
 08-0180
 - 08-0184

leichte Modelle
 light patterns
 modelos ligeros
 modèles légers
 modelli leggeri

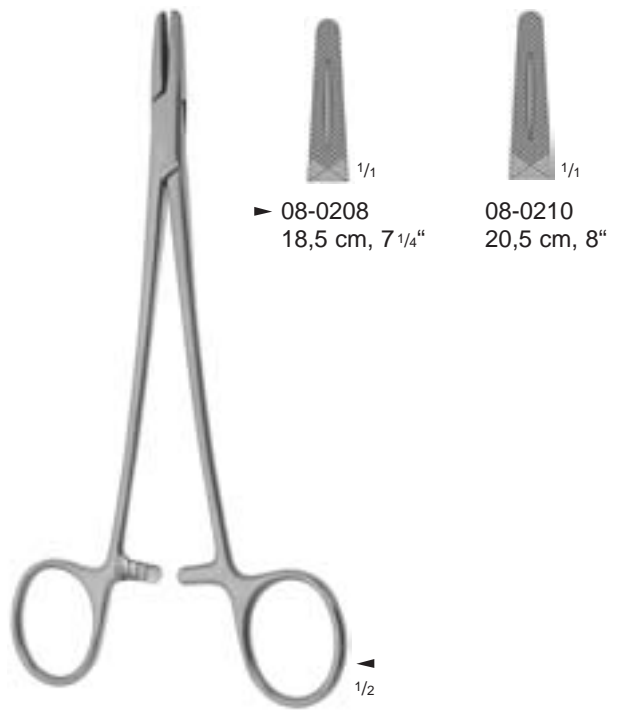

▶ 08-0208 18,5 cm, 7 1/4" 08-0210 20,5 cm, 8"

MAYO-HEGAR
 08-0208
 - 08-0210

kräftige Modelle
 heavy patterns
 modelos robustos
 modèles forts
 modelli robusti



NEW ORLEANS
 08-0040
 17,5 cm, 7"



ADSON
 08-0090
 18 cm, 7"

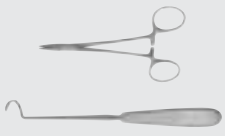

Nadelhalter
Needle Holders
Porta-agujas
Porte-aiguilles
Portaghi



CRILE-WOOD
08-0071
20,5 cm, 8"



JAMESON
08-0075
23 cm, 9"



MASSON
08-0340
26,5 cm, 10 1/2"

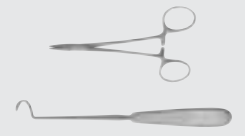

WANGENSTEEN
08-0364
27 cm, 10³/₄"



HEANEY
08-0350
20,5 cm, 8"



FINOCHIETTO
08-0356
26,5 cm, 10¹/₂"

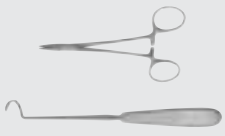

Nadelhalter mit Schere
 Needle Holders with Scissors
 Porta-agujas con tijera
 Porte-aiguilles avec ciseaux
 Portaghi con forbici



OLSEN-HEGAR
 08-0112
 13,5 cm, 5 1/4"



OLSEN-HEGAR
 08-0114
 17 cm, 6 3/4"



OLSEN-HEGAR
 08-0116
 18,5 cm, 7 1/4"

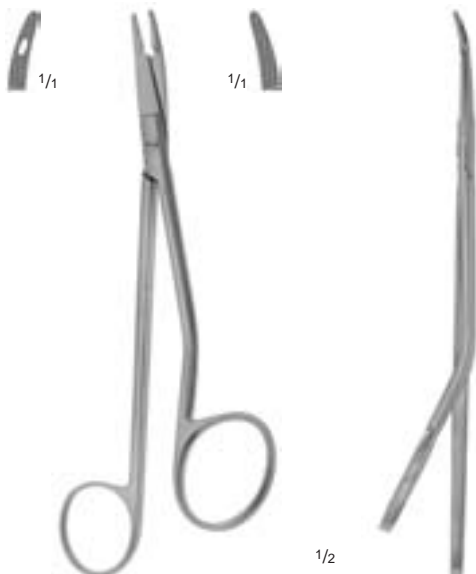

BABY-GILLIES
 08-0176
 15 cm, 6"

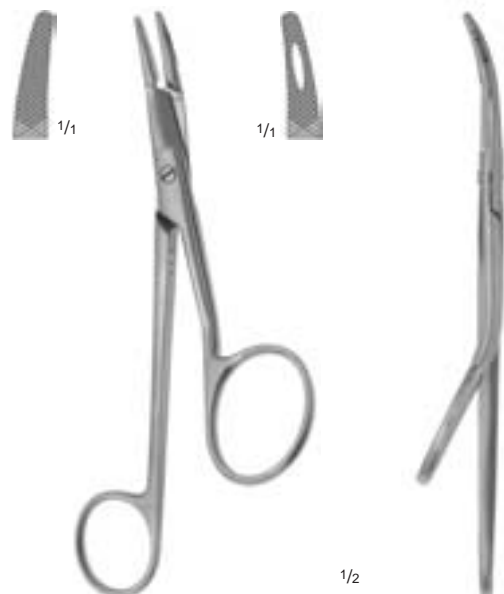

GILLIES
 08-0179
 15,5 cm, 6"

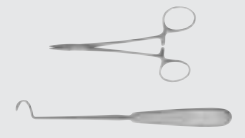

MATHIEU
 08-0337
 - 08-0339



08-0337
 14 cm, 5 1/2"



▶ 08-0338
 16,5 cm, 6 1/2"



08-0339
 20 cm, 8"



CRILE
 08-0092
 15 cm, 6"



TOENNIS
 08-0342
 18,5 cm, 7 1/4"



elastisches Modell
 elastic pattern
 modelo elástico
 modèle souple
 modello elastico

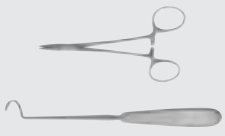

Bumerang-Nadelhalter
Boomerang Needle Holders
Porta-agujas de bumerang
Porte-aiguilles boomerangs
Portaghi a boomerang



1/2

YOUNG-MILLIN
92-0340
21,5 cm, 8 1/2"

Bumerang-Nadelhalter
mit 1 Nadel 92-0341
Boomerang needle holder
with 1 needle 92-0341
Porta-aguja de bumerang
con 1 aguja 92-0341
Porte-aiguilles boomerang
avec 1 aiguille 92-0341
Portaghi a boomerang con
1 ago 92-0341



1/2

YOUNG-HRYNTSCHAK
92-0338
26 cm, 10 1/4"

Bumerang-Nadelhalter
mit 1 Nadel 92-0341
Boomerang needle holder
with 1 needle 92-0341
Porta-aguja de bumerang
con 1 aguja 92-0341
Porte-aiguilles boomerang avec 1
aiguille 92-0341
Portaghi a boomerang con
1 ago 92-0341



1/1

92-0341



1/1

92-0342



1/1

92-0343

92-0341
- 92-0343

Ersatznadeln
Spare needles
Agujas de repuesto
Aiguilles de rechange
Aghi di ricambio

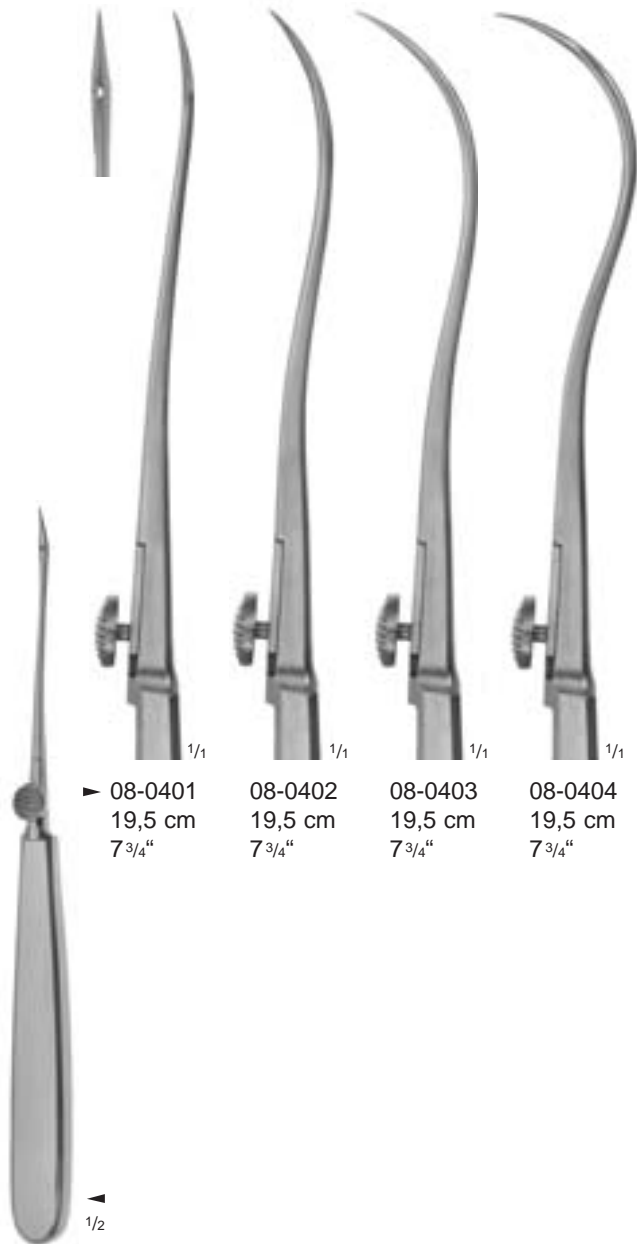
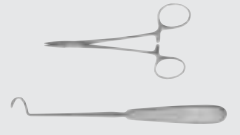

| | | | |
|-----------|---------|---------|---------|
| ▶ 08-0401 | 08-0402 | 08-0403 | 08-0404 |
| 19,5 cm | 19,5 cm | 19,5 cm | 19,5 cm |
| 7 3/4" | 7 3/4" | 7 3/4" | 7 3/4" |

REVERDIN
 08-0401
 - 08-0404

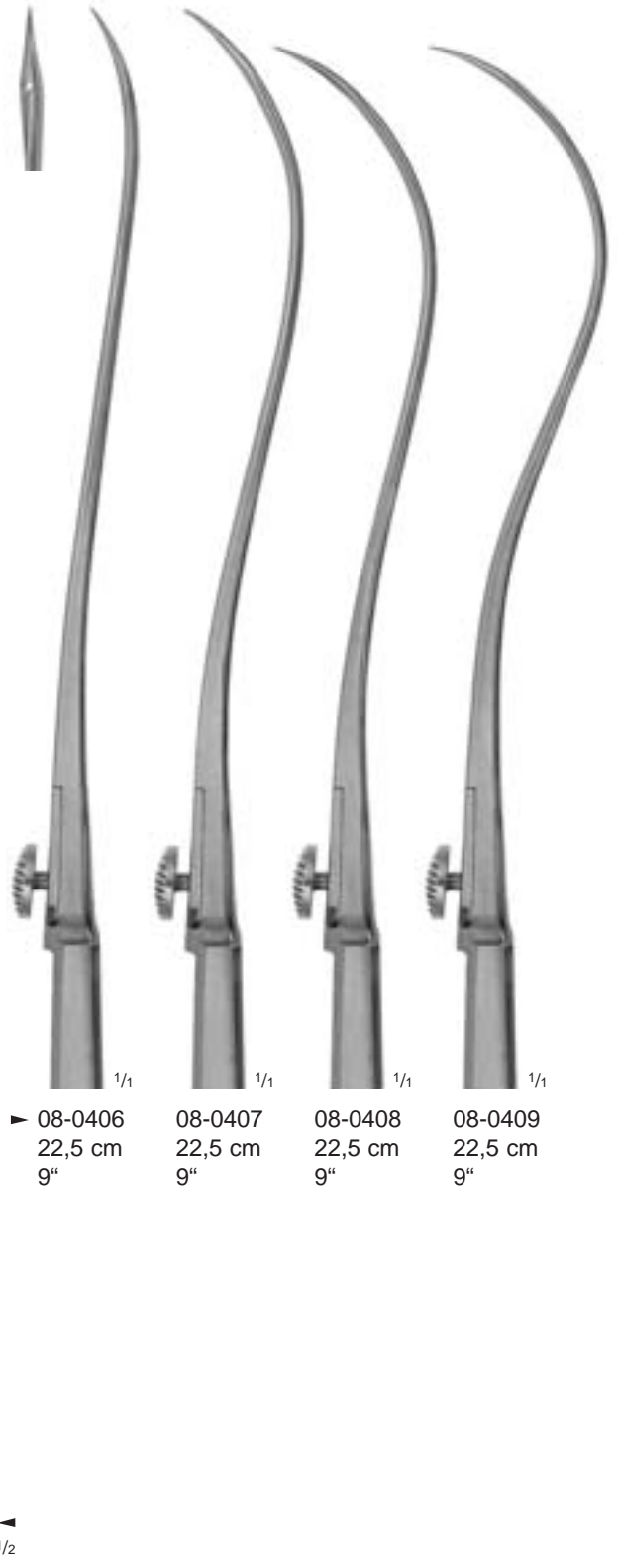

| | | | |
|-----------|---------|---------|---------|
| ▶ 08-0406 | 08-0407 | 08-0408 | 08-0409 |
| 22,5 cm | 22,5 cm | 22,5 cm | 22,5 cm |
| 9" | 9" | 9" | 9" |

REVERDIN
 08-0406
 - 08-0409

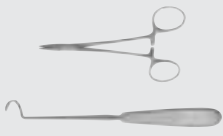

Unterbindungsadeln
 Ligature Needles
 Agujas para ligaduras
 Aiguilles à ligatures
 Aghi per legatura

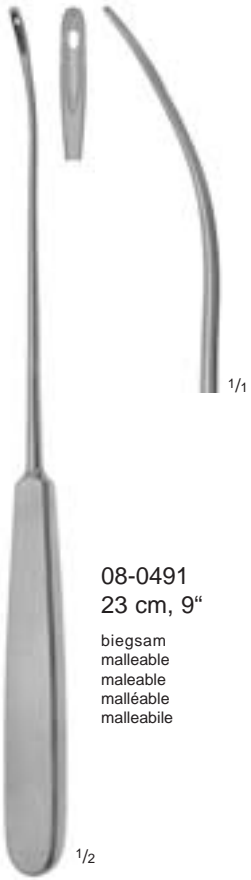

08-0491
 23 cm, 9"

biegsam
 malleable
 maleable
 malléable
 malleabile

1/2



KRONECKER
 08-0413
 15 cm, 6"

für die rechte
 Hand, stumpf
 for the right
 hand, blunt
 para la mano
 derecha, roma
 pour la main
 droite, mousse
 per la mano
 destra, smusso

1/2

KRONECKER
 08-0412
 15 cm, 6"

für die linke
 Hand, stumpf
 for the left
 hand, blunt
 para la mano
 izquierda, roma
 pour la main
 gauche, mousse
 per la mano
 sinistra, smusso



HURD
 81-0308
 22,5 cm, 9"

für die rechte
 Hand, scharf
 for the right
 hand, sharp
 para la mano
 derecha, aguda
 pour la main
 droite, pointue
 per la mano
 destra, acuto

1/2

HURD
 81-0309
 22,5 cm, 9"

für die linke
 Hand, scharf
 for the left
 hand, sharp
 para la mano
 izquierda, aguda
 pour la main
 gauche, pointue
 per la mano
 sinistra, acuto



COOPER
 08-0484
 19 cm, 7 1/2"

1/2

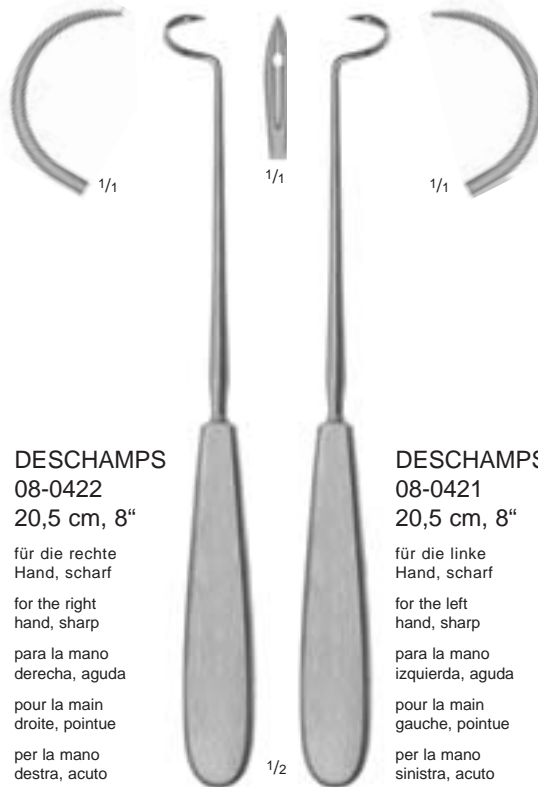

DESCHAMPS
 08-0422
 20,5 cm, 8"

für die rechte
 Hand, scharf
 for the right
 hand, sharp
 para la mano
 derecha, aguda
 pour la main
 droite, pointue
 per la mano
 destra, acuto

1/2

DESCHAMPS
 08-0421
 20,5 cm, 8"

für die linke
 Hand, scharf
 for the left
 hand, sharp
 para la mano
 izquierda, aguda
 pour la main
 gauche, pointue
 per la mano
 sinistra, acuto

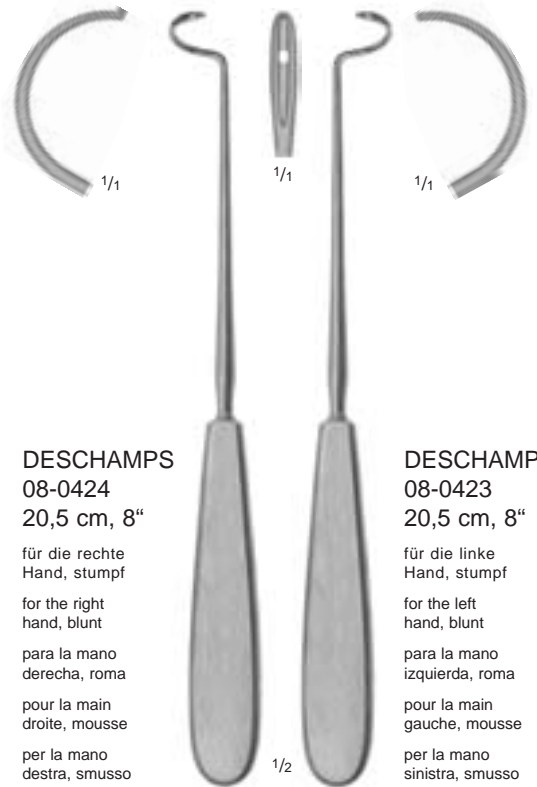

DESCHAMPS
 08-0424
 20,5 cm, 8"

für die rechte
 Hand, stumpf
 for the right
 hand, blunt
 para la mano
 derecha, roma
 pour la main
 droite, mousse
 per la mano
 destra, smusso

1/2

DESCHAMPS
 08-0423
 20,5 cm, 8"

für die linke
 Hand, stumpf
 for the left
 hand, blunt
 para la mano
 izquierda, roma
 pour la main
 gauche, mousse
 per la mano
 sinistra, smusso

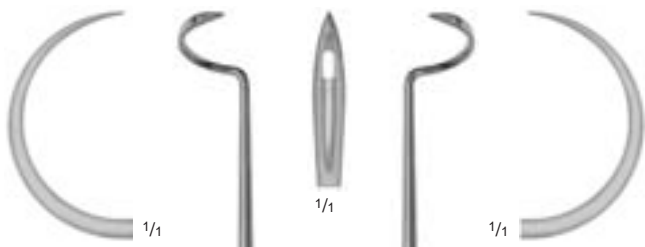
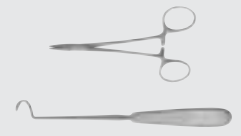

DESCHAMPS
 08-0426
 20,5 cm, 8"

für die rechte Hand, scharf
 for the right hand, sharp
 para la mano derecha, aguda
 pour la main droite, pointue
 per la mano destra, acuto

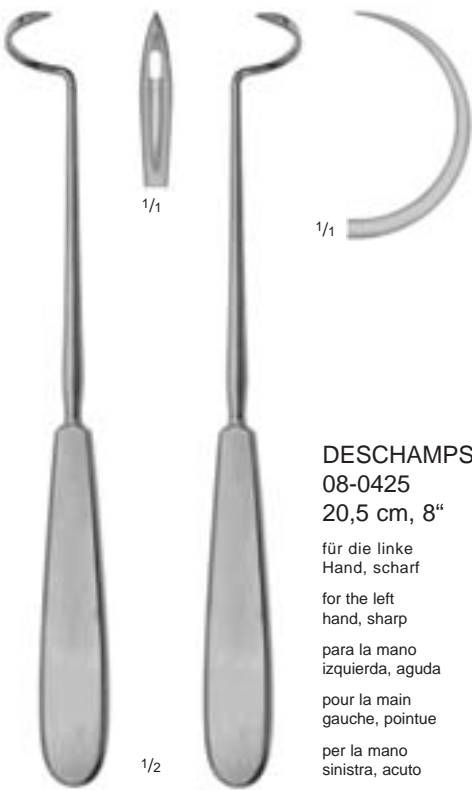

DESCHAMPS
 08-0425
 20,5 cm, 8"

für die linke Hand, scharf
 for the left hand, sharp
 para la mano izquierda, aguda
 pour la main gauche, pointue
 per la mano sinistra, acuto

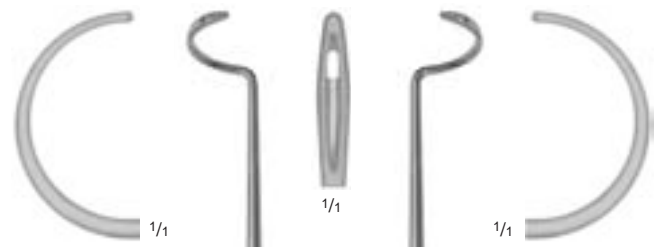

DESCHAMPS
 08-0428
 20,5 cm, 8"

für die rechte Hand, stumpf
 for the right hand, blunt
 para la mano derecha, roma
 pour la main droite, mousse
 per la mano destra, smusso

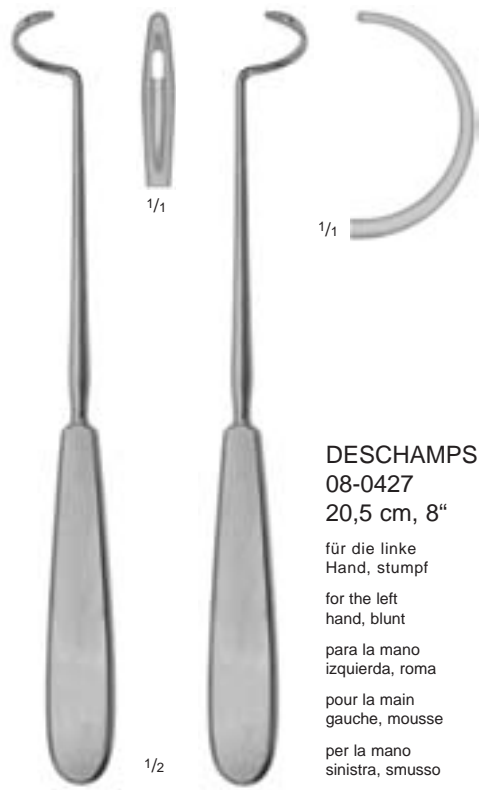

DESCHAMPS
 08-0427
 20,5 cm, 8"

für die linke Hand, stumpf
 for the left hand, blunt
 para la mano izquierda, roma
 pour la main gauche, mousse
 per la mano sinistra, smusso

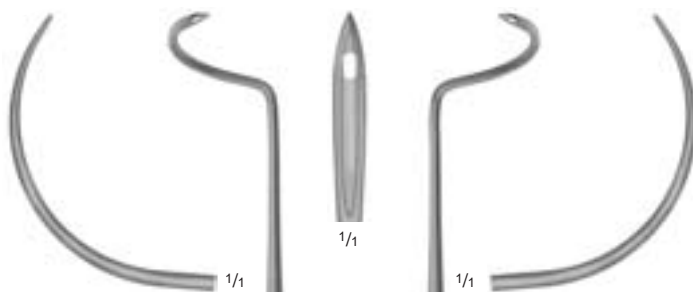

DESCHAMPS
 08-0438
 24 cm, 9 1/2"

für die rechte Hand, scharf
 for the right hand, sharp
 para la mano derecha, aguda
 pour la main droite, pointue
 per la mano destra, acuto

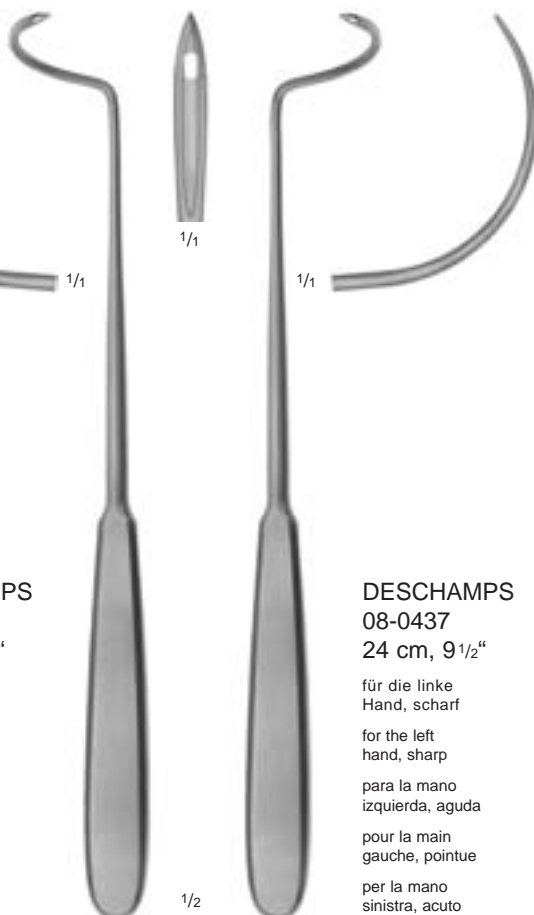

DESCHAMPS
 08-0437
 24 cm, 9 1/2"

für die linke Hand, scharf
 for the left hand, sharp
 para la mano izquierda, aguda
 pour la main gauche, pointue
 per la mano sinistra, acuto

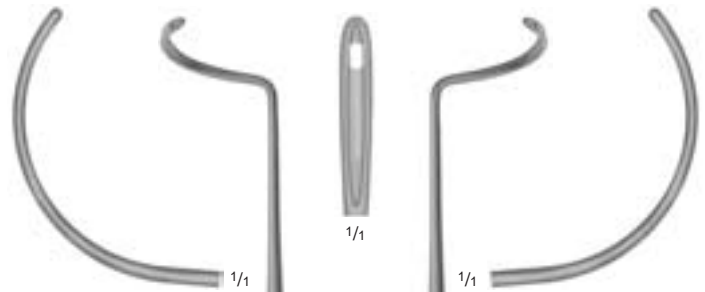

DESCHAMPS
 08-0465
 24 cm, 9 1/2"

für die rechte Hand, stumpf
 for the right hand, blunt
 para la mano derecha, roma
 pour la main droite, mousse
 per la mano destra, smusso

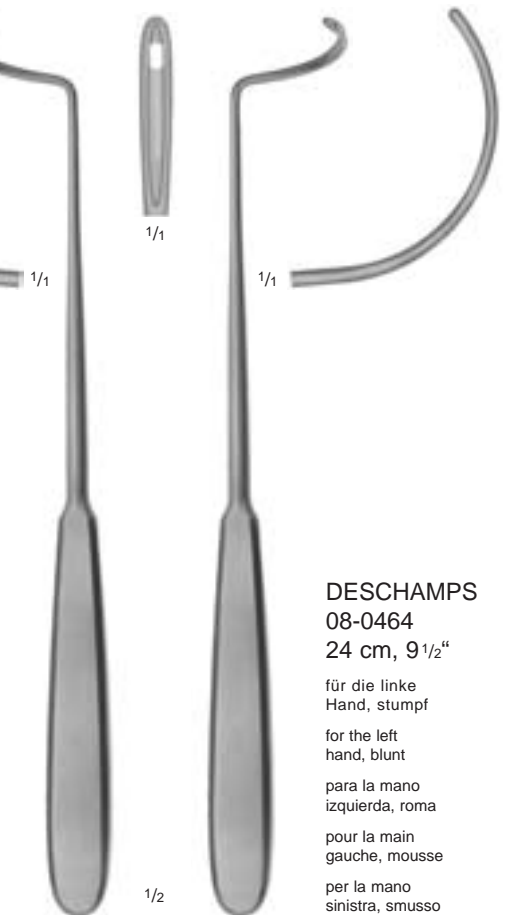

DESCHAMPS
 08-0464
 24 cm, 9 1/2"

für die linke Hand, stumpf
 for the left hand, blunt
 para la mano izquierda, roma
 pour la main gauche, mousse
 per la mano sinistra, smusso

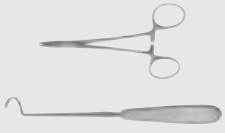

Unterbindungsadeln
Ligature Needles
Agujas para ligaduras
Aiguilles à ligatures
Aghi per legatura

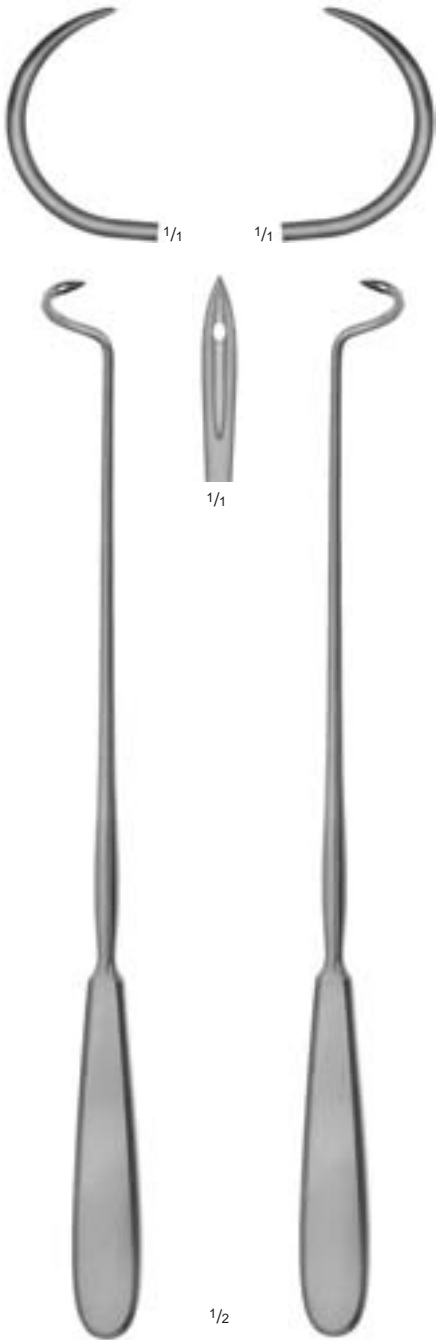

DESCHAMPS
08-0477
28 cm, 11"

für die rechte
Hand, scharf

for the right
hand, sharp

para la mano
derecha, aguda

pour la main
droite, pointue

per la mano
destra, acuto

DESCHAMPS
08-0476
28 cm, 11"

für die linke
Hand, scharf

for the left
hand, sharp

para la mano
izquierda, aguda

pour la main
gauche, pointue

per la mano
sinistra, acuto

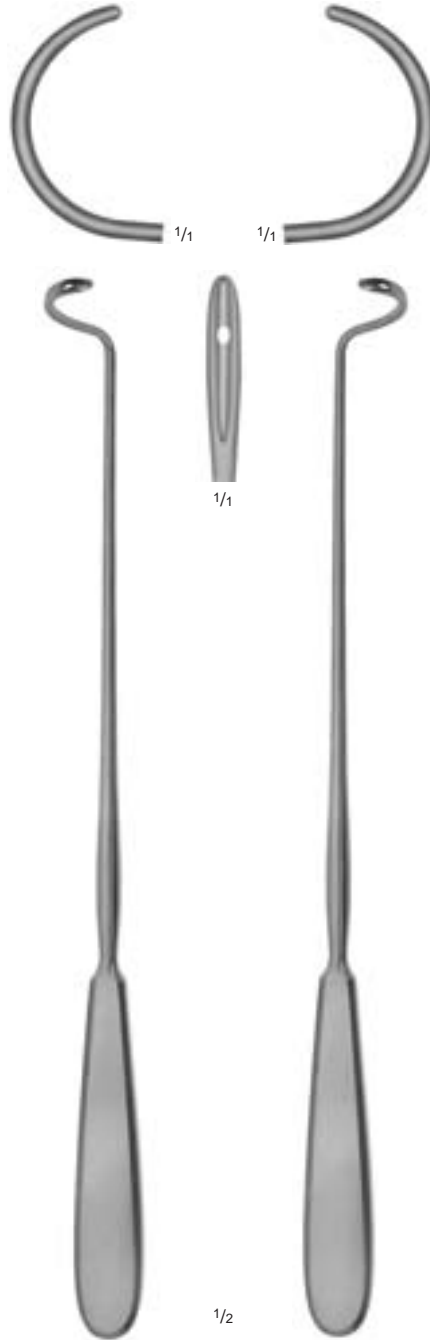

DESCHAMPS
08-0479
28 cm, 11"

für die rechte
Hand, stumpf

for the right
hand, blunt

para la mano
derecha, roma

pour la main
droite, mousse

per la mano
destra, smusso

DESCHAMPS
08-0478
28 cm, 11"

für die linke
Hand, stumpf

for the left
hand, blunt

para la mano
izquierda, roma

pour la main
gauche, mousse

per la mano
sinistra, smusso

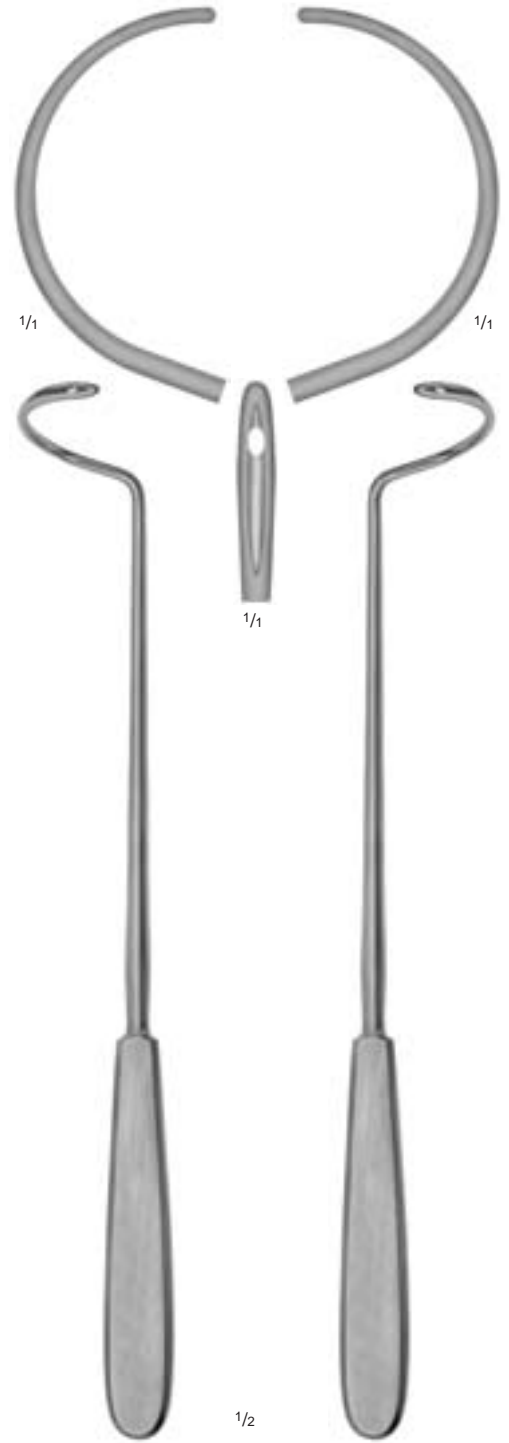

DESCHAMPS
08-0463
28 cm, 11"

für die rechte
Hand, stumpf

for the right
hand, blunt

para la mano
derecha, roma

pour la main
droite, mousse

per la mano
destra, smusso

DESCHAMPS
08-0462
28 cm, 11"

für die linke
Hand, stumpf

for the left
hand, blunt

para la mano
izquierda, roma

pour la main
gauche, mousse

per la mano
sinistra, smusso

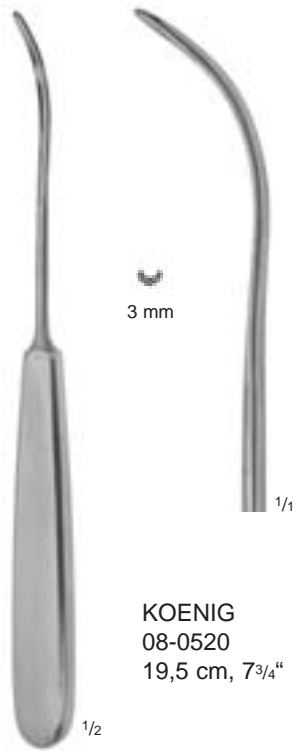
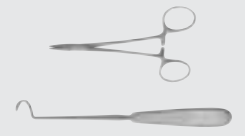

KOENIG
 08-0520
 19,5 cm, 7³/₄"

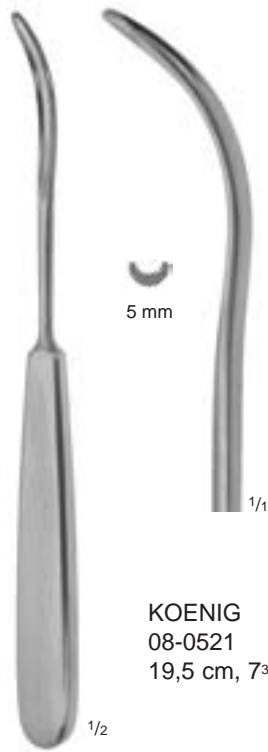

KOENIG
 08-0521
 19,5 cm, 7³/₄"

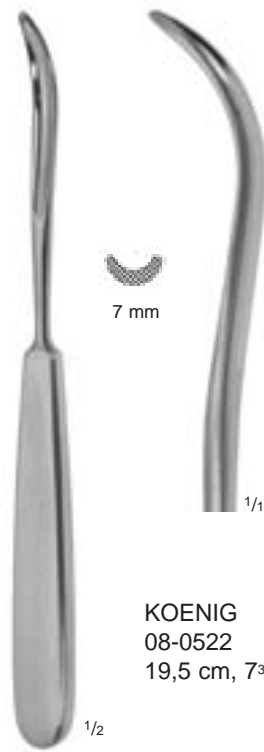

KOENIG
 08-0522
 19,5 cm, 7³/₄"



KIRSCHNER
 08-0548
 25,5 cm, 10"

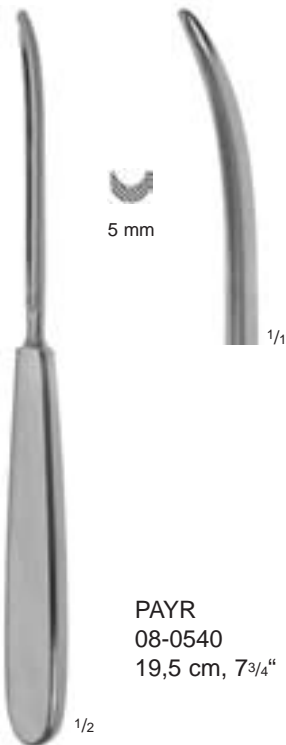

PAYR
 08-0540
 19,5 cm, 7³/₄"

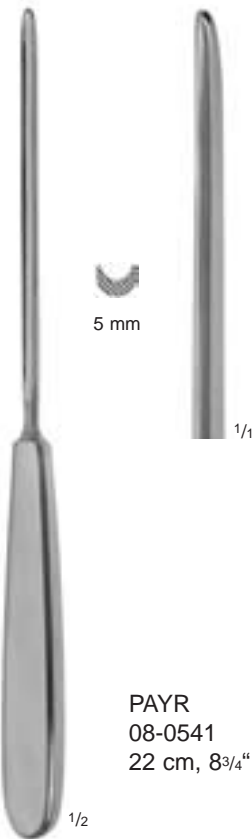

PAYR
 08-0541
 22 cm, 8³/₄"

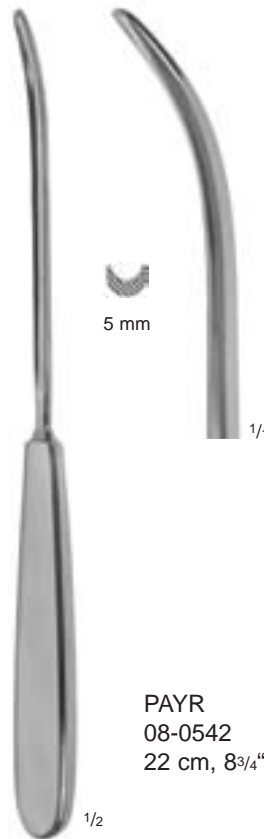

PAYR
 08-0542
 22 cm, 8³/₄"

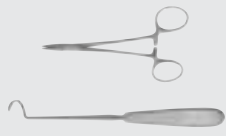

Führungshohlsonden
Ligature Conductors
Sondas conductoras
Spatules conductrices
Sonda conduttrici

Nahtinstrumente
Suture Instruments
Instrumentos para sutura
Instruments à suture
Strumenti per sutura

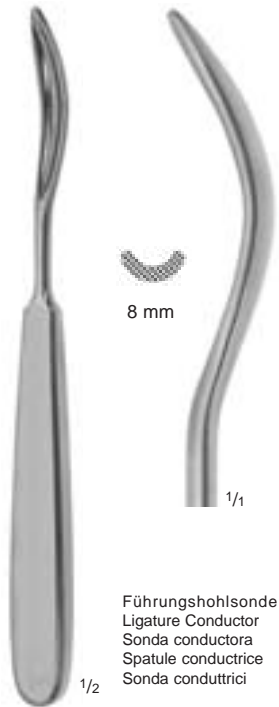

8 mm

1/1

Führungshohlsonde
Ligature Conductor
Sonda conductora
Spatule conductrice
Sonda conduttrici

1/2

SCHMIEDEN
08-0525
18,5 cm, 7 1/4"

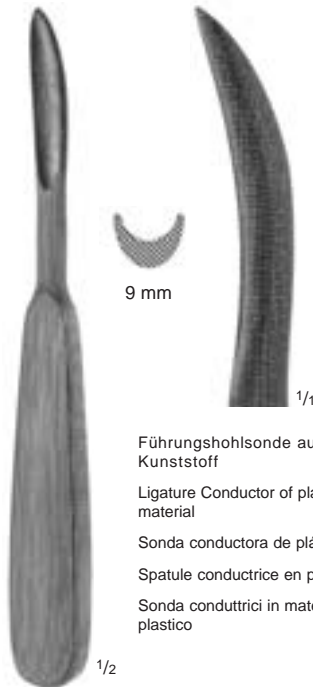

9 mm

1/1

Führungshohlsonde aus
Kunststoff

Ligature Conductor of plastic
material

Sonda conductora de plástico

Spatule conductrice en plastique

Sonda conduttrici in materiale
plastico

1/2

08-0552
18 cm, 7"

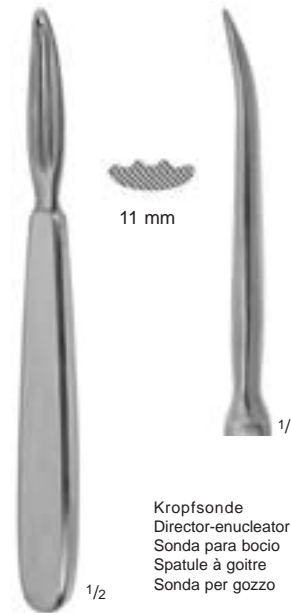

11 mm

1/1

Kropfsonde
Director-enucleator
Sonda para bocio
Spatule à goitre
Sonda per gozzo

1/2

KOCHER
12-0200
16 cm, 6 1/4"



12 mm

1/1

Kropfsonde
Director-enucleator
Sonda para bocio
Spatule à goitre
Sonda per gozzo

1/2

KOCHER
12-0201
17 cm, 6 3/4"



CHILDE
08-0772
17 cm, 6 3/4"

Wundnahtpinzette
ohne Klammerhalter

Approximation forceps
without clip holder

Pinza aproximadora
sin porta-clips

Pince à affronter sans
porte agrafes

Pinza senza porta clips

1/2



CHILDE
08-0775
17 cm, 6 3/4"

Wundnahtpinzette
mit Klammerhalter

Approximation forceps
with clip holder

Pinza aproximadora
con porta-clips

Pince à affronter avec
porte agrafes

Pinza con porta clips

1/2

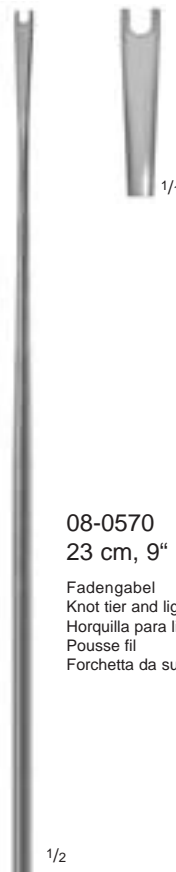

1/1

08-0570
23 cm, 9"

Fadengabel
Knot tier and ligature adjuster
Horquilla para ligadura
Pousse fil
Forchetta da sutura

1/2



1/1

WIENER MOD.
08-0572
23,5 cm, 9 1/4"

Fadenfänger
Suture catcher
Porta ligadura
Porte-ligature
Portalegature

1/2

Wundklammern
Suture Clips
Agrafes (Grapas)
Agrafes
Agrafes

Klammeranlege- und Entfernungsanzgen
Clip Applying and Removing Forceps
Pinzas para poner y quitar agrafes
Pincas à poser et retirer les agrafes
Pinze metti e togli clips

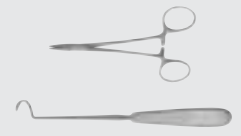

| | | |
|--|---------|-------------|
| | 08-0611 | 11 x 2,0 mm |
| | 08-0612 | 12 x 2,5 mm |
| | 08-0614 | 14 x 3,0 mm |
| | 08-0616 | 16 x 3,0 mm |
| | 08-0618 | 18 x 3,0 mm |
| | 08-0620 | 20 x 3,0 mm |
| | 08-0622 | 22 x 3,0 mm |

MICHEL
08-0611
- 08-0622

Wundklammern aus nichtrostendem Stahl, in Packungen zu 100 Stück
Suture clips of stainless steel, in packages of 100 pieces
Agrafes (grapas) de acero inoxidable, paquete de 100 piezas
Agrafes acier inoxydable, paquet de 100
Agrafes clips da sutura in acciaio inox in conf. 100 pz.



MICHEL
08-0600
12 cm, 4³/₄"

Klammeranlegepinzette
Clip applying forceps
Pinza para poner agrafes
Pince à poser les agrafes
Pinza per mettere clips



HEGENBARTH
08-0605
12 cm, 4³/₄"

Klammeranlegepinzette
Clip applying forceps
Pinza para poner agrafes
Pince à poser les agrafes
Pinza per mettere clips



MICHEL
08-0610
12,5 cm, 5"

Klammeranlege- und Entfernungsanzge
Clip applying and removing forceps
Pinza para poner y quitar agrafes
Pince à poser et retirer les agrafes
Pinca per mettere e togliere clips



COLLIN
08-0652
13,5 cm, 5¹/₄"

Klammerentfernungsanzge
Clip removing forceps
Pinza para quitar agrafes
Pince à retirer les agrafes
Pinca per togliere clips



RICHTER-HEATH
08-0650
13,5 cm, 5¹/₄"

Klammerentfernungsanzge
Clip removing forceps
Pinza para quitar agrafes
Pince à retirer les agrafes
Pinca per togliere clips

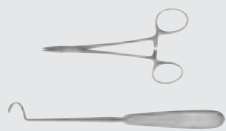

Wundnahtbesteck
Suturing Instrument Set
Estuche para sutura
Necessaire à sutures
Set per sutura

08-0910

Wundnahtbesteck, komplett, bestehend aus:

- 04-1023 3 Sterile Skalpellklingen Fig. 23
- 04-1055 1 Skalpellgriff No. 4
- 05-0111 1 Schere, spitz/stumpf, gerade, 13 cm, 5¹/₈"
- 09-0040 1 SEMKEN Anatomische Pinzette 12 cm, 4³/₄"
- 08-1670 1 Nähseide No. 1, gedreht, Strang zu 0,5 g., steril, im Glasflacon
- 08-1212 1 Chirurgische Nähnadel B, Fig. 12
- 08-1231 1 Chirurgische Nähnadel G, Fig. 11
- 08-1235 1 Chirurgische Nähnadel G, Fig. 15
- 08-1660 1 Nadel-Sterilisierdose 50 x 25 x 4,5 mm
- 08-0337 1 MATHIEU Nadelhalter 14 cm, 5¹/₂"
- 08-0610 1 MICHEL Klammeranlege- und Entfernungszange 12,5 cm, 5"
- 08-0616 25 MICHEL Wundklammern 16 x 3 mm
- 08-1632 1 Metall-Etui 165 x 90 x 23 mm

Suturing instrument set, complete, consisting of:

- 04-1023 3 Sterile scalpel blades No. 23
- 04-1055 1 Scalpel handle No. 4
- 05-0111 1 Scissors, blunt/sharp, straight, 13 cm, 5¹/₈"
- 09-0040 1 SEMKEN Dissecting forceps, 12 cm, 4³/₄"
- 08-1670 1 Suture silk No. 1, twisted, hank of 0.5 gramme, sterilized, in glass flacon
- 08-1212 1 Surgical suture needle B, fig. 12
- 08-1231 1 Surgical suture needle G, fig. 11
- 08-1235 1 Surgical suture needle G, fig. 15
- 08-1660 1 Needle sterilizing box, 50 x 25 x 4.5 mm
- 08-0337 1 MATHIEU Needle holder, 14 cm, 5¹/₂"
- 08-0610 1 MICHEL Clip applying and removing forceps, 12.5 cm, 5"
- 08-0616 25 MICHEL Suture clips, 16 x 3 mm
- 08-1632 1 Metal case, 165 x 90 x 23 mm

Estuche para sutura, completo, compuesto de:

- 04-1023 3 Hojas de bisturíes núm. 23, estériles
- 04-1055 1 Mango de bisturí núm. 4
- 05-0111 1 Tijera, roma/aguda, recta, 13 cm, 5¹/₈"
- 09-0040 1 Pinza de disección de SEMKEN, 12 cm, 4³/₄"
- 08-1670 1 Seda para sutura, núm. 1, hilado, madeja de 0,5 gr., estéril, en frasquito de vidrio
- 08-1212 1 Aguja para sutura cirugía B, núm. 12
- 08-1231 1 Aguja para sutura cirugía G, núm. 11
- 08-1235 1 Aguja para sutura cirugía G, núm. 15
- 08-1660 1 Estuche para esterilizar agujas, 50 x 25 x 4,5 mm
- 08-0337 1 Porta-agujas de MATHIEU, 14 cm, 5¹/₂"
- 08-0610 1 Pinza para poner y quitar agrafes de MICHEL, 12,5 cm, 5"
- 08-0616 25 Agrafes (grapas) de MICHEL, 16 x 3 mm
- 08-1632 1 Estuche de metal, 165 x 90 x 23 mm

Necessaire à suture, complet, composé de:

- 04-1023 3 Paquets de lames No. 23
- 04-1055 1 Manche No. 4
- 05-0111 1 Ciseaux, pointu/mousse, droits, 13 cm, 5¹/₈"
- 09-0040 1 Pince à dissection de SEMKEN, 12 cm, 4³/₄"
- 08-1670 1 Soie à suture No.1, torsadée, fil de 0,5 g, stérile en flacon verre
- 08-1212 1 Aiguilles à sutures B, fig. 12
- 08-1231 1 Aiguilles à sutures G, fig. 11
- 08-1235 1 Aiguilles à sutures G, fig. 15
- 08-1660 1 Boîte à stériliser les aiguilles, 50 x 25 x 4,5 mm
- 08-0337 1 Porte-aiguille de MATHIEU, 14 cm, 5¹/₂"
- 08-0610 1 Pince à poser et retirer les agrafes de MICHEL, 12,5 cm, 5"
- 08-0616 25 Agrafes de MICHEL, 16 x 3 mm
- 08-1632 1 Boîte métal, 165 x 90 x 23 mm

Set per sutura, completo, composto da:

- 04-1023 3 lame per bisturi fig. 23
- 04-1055 1 Bisturi a lame No. 4
- 05-0111 1 Forbice, acuta/smussa, retta, 13 cm, 5¹/₈"
- 09-0040 1 Pinza anatomica SEMKEN, 12 cm, 4³/₄"
- 08-1670 1 Seta intrecciata, No. 1, 0,5 g, sterilizzabile in flacon vetro
- 08-1212 1 Ago chirurgica per sutura B, fig. 12
- 08-1231 1 Ago chirurgica per sutura G, fig. 11
- 08-1235 1 Ago chirurgica per sutura G, fig. 15
- 08-1660 1 Scatola per sterilizzazione per aghi, 50 x 25 x 4,5 mm
- 08-0337 1 Portaghi MATHIEU, 14 cm, 5¹/₂"
- 08-0610 1 Pinza MICHEL per mettere e togliere clips, 12,5 cm, 5"
- 08-0616 25 Agrafes MICHEL, 16 x 3 mm
- 08-1632 1 Scatola metallica, 165 x 90 x 23 mm



1/3

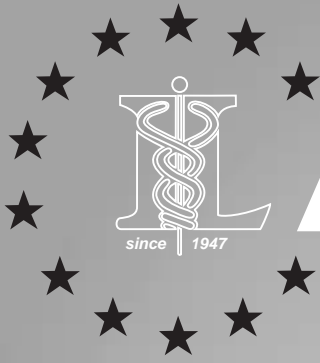

LAWNTON

Medizintechnik



Darm, Magen, Mastdarm
Intestines, Stomach, Rectum
Intestino, Estómago, Recto
Intestins, Estomac, Rectum
Intestino, Stomaco, Retto



Instrumente für Darm, Magen und Mastdarm
 Instruments for Intestines, Stomach and Rectum
 Instrumentos para intestino, estómago y recto
 Instruments pour intestin, estomac, rectum
 Strumenti per intestino, stomaco, retto



| | | |
|--|--------|----|
| Darm- und Gewebefaßzangen | Seite | 23 |
| Intestinal and Tissue Grasping Forceps | Page | 23 |
| Pinzas intestinales y para tejidos | Página | 23 |
| Pinces à préhension de l'intestin | Page | 23 |
| Pinze da presa per intestino e tessuti | Pagina | 23 |



| | | |
|---------------------------|--------|--------|
| Rektumscheren | Seite | 59, 99 |
| Rectal Scissors | Page | 59, 99 |
| Tijeras rectales | Página | 59, 99 |
| Ciseaux pour rectum | Page | 59, 99 |
| Forbici per retto | Pagina | 59, 99 |



| | | |
|---|--------|---------------------|
| Darm- und Gewebefaßpinzetten | Seite | 115, 135, 148 - 149 |
| Intestinal and Tissue Grasping Forceps | Page | 115, 135, 148 - 149 |
| Pinzas intestinales y para tejidos | Página | 115, 135, 148 - 149 |
| Pinces à préhension de l'intestin | Page | 115, 135, 148 - 149 |
| Pinze anatomiche da presa per intestino e tessuti | Pagina | 115, 135, 148 - 149 |



| | | |
|-------------------------------|--------|-----------|
| Pelvishaken | Seite | 256 - 258 |
| Pelvis Retractors | Page | 256 - 258 |
| Separadores para pelvis | Página | 256 - 258 |
| Ecarteurs à pelviens | Page | 256 - 258 |
| Divaricatori per pelvi | Pagina | 256 - 258 |



| | | |
|--|--------|-----|
| Appendektomie-Wundspreizer | Seite | 284 |
| Appendectomy Retractors | Page | 284 |
| Separadores para apendectomía | Página | 284 |
| Ecarteurs pour appendectomie | Page | 284 |
| Divaricatori per appendicectomia | Pagina | 284 |



| | | |
|----------------------------|--------|-----|
| Analsonden | Seite | 314 |
| Rectal Probes | Page | 314 |
| Sondas para el recto | Página | 314 |
| Sondes rectales | Page | 314 |
| Sonde rettali | Pagina | 314 |

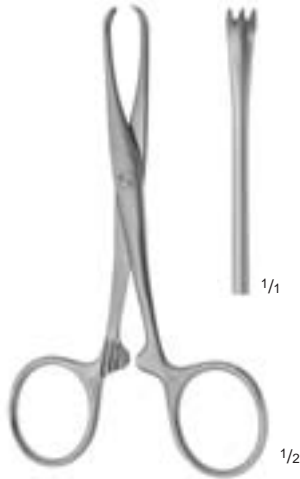

CHAPUT
 10-0102
 12,5 cm, 5"

2x3 Zähne
 2x3 teeth
 2x3 dientes
 2x3 dents
 2x3 denti

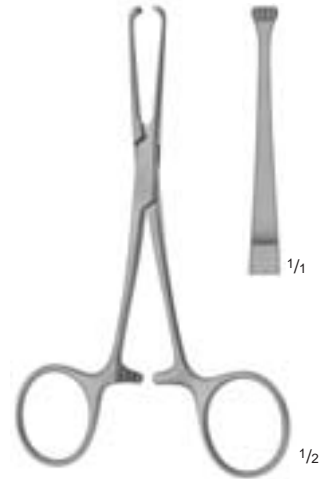

BABY-ALLIS
 10-0106
 12 cm, 4 3/4"

4x5 Zähne
 4x5 teeth
 4x5 dientes
 4x5 dents
 4x5 denti

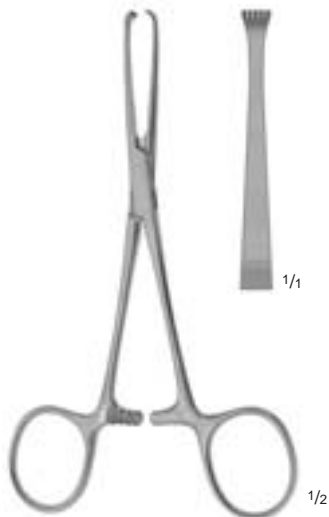

OCHSNER-ALLIS
 10-0105
 13,5 cm, 5 1/4"

4x5 Zähne
 4x5 teeth
 4x5 dientes
 4x5 dents
 4x5 denti

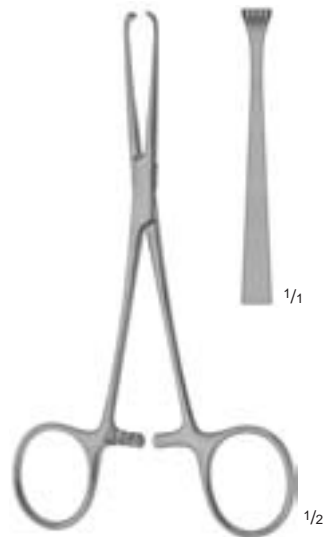

BABY-ALLIS
 10-0127
 14 cm, 5 1/2"

4x5 Zähne
 4x5 teeth
 4x5 dientes
 4x5 dents
 4x5 denti

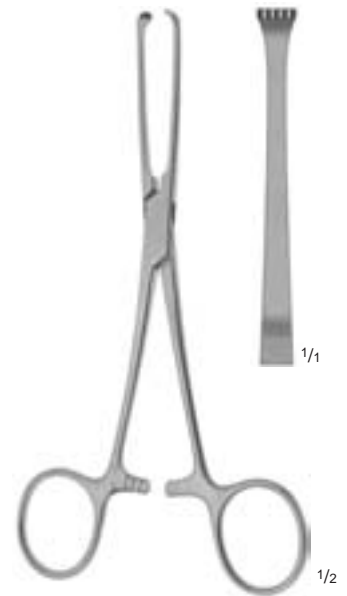

ALLIS
 10-0120
 15,5 cm, 6"

4x5 Zähne
 4x5 teeth
 4x5 dientes
 4x5 dents
 4x5 denti



Darm- und Gewebefaßzangen
Intestinal and Tissue Grasping Forceps
Pinzas intestinales y para tejidos
Pinces à préhension de l'intestin
Pinze da presa per intestino e tessuti

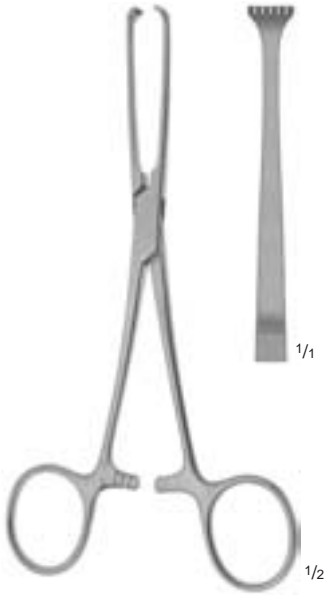

ALLIS
10-0125
15,5 cm, 6"

5x6 Zähne
5x6 teeth
5x6 dientes
5x6 dents
5x6 denti

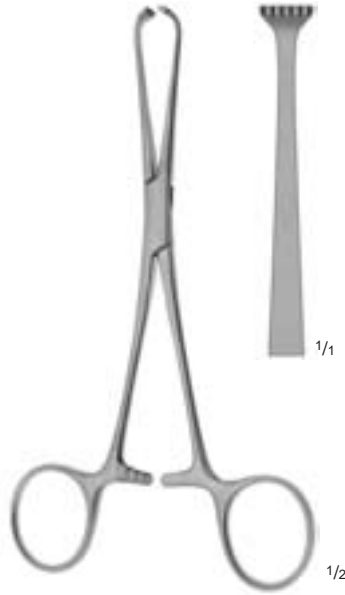

BOYS-ALLIS
10-0166
15,5 cm, 6"

5x6 Zähne
5x6 teeth
5x6 dientes
5x6 dents
5x6 denti

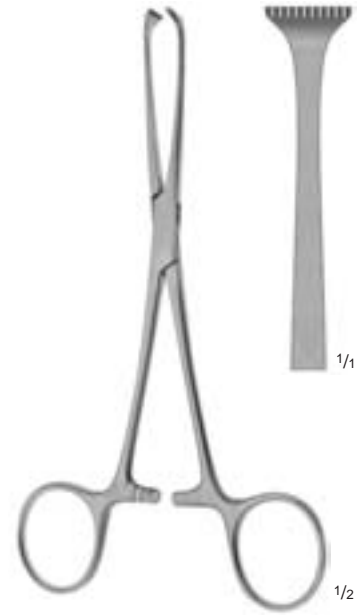

ADAIR-ALLIS
10-0140
16 cm, 6 1/4"

10x11 Zähne
10x11 teeth
10x11 dientes
10x11 dents
10x11 denti

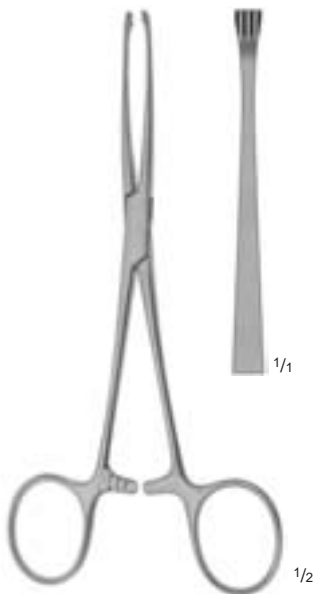

JUDD-ALLIS
10-0110
15,5 cm, 6"

3x4 Zähne
3x4 teeth
3x4 dientes
3x4 dents
3x4 denti

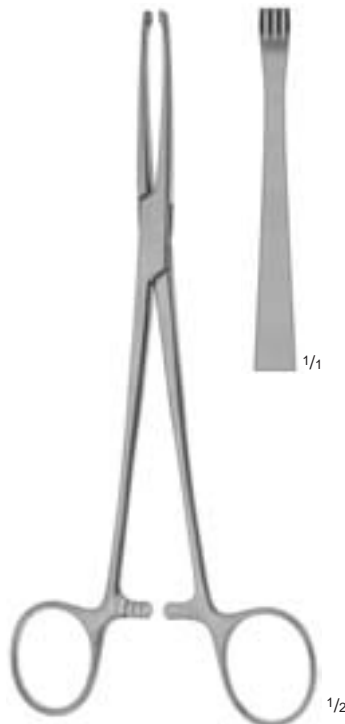

JUDD-ALLIS
10-0115
19 cm, 7 1/2"

3x4 Zähne
3x4 teeth
3x4 dientes
3x4 dents
3x4 denti

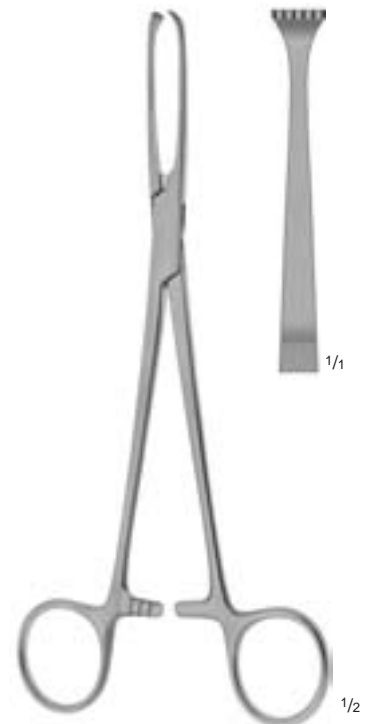

ALLIS
10-0130
19 cm, 7 1/2"

5x6 Zähne
5x6 teeth
5x6 dientes
5x6 dents
5x6 denti



8x9 Zähne
 8x9 teeth
 8x9 dientes
 8x9 dents
 8x9 denti

THOMS-ALLIS
 10-0135
 20,5 cm, 8"

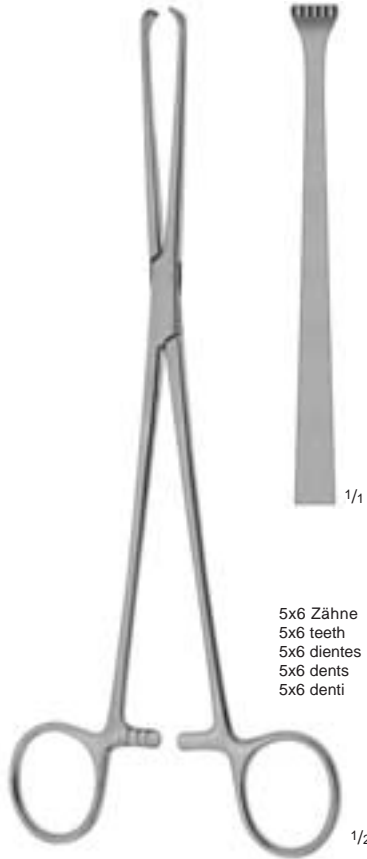

5x6 Zähne
 5x6 teeth
 5x6 dientes
 5x6 dents
 5x6 denti

ALLIS
 10-0132
 22,5 cm, 9"



5x6 Zähne
 5x6 teeth
 5x6 dientes
 5x6 dents
 5x6 denti

ALLIS
 10-0138
 25 cm, 10"



BABCOCK
 10-0143
 - 10-0160



10-0143
 14,5 cm, 5 3/4"



▶ 10-0145
 16 cm, 6 1/4"



10-0150
 17 cm, 6 3/4"



10-0155
 20,5 cm, 8"



10-0160
 23,5 cm, 9 1/4"



Darm- und Gewebefaßzangen
Intestinal and Tissue Grasping Forceps
Pinzas intestinales y para tejidos
Pinces à préhension de l'intestin
Pinze da presa per intestino e tessuti

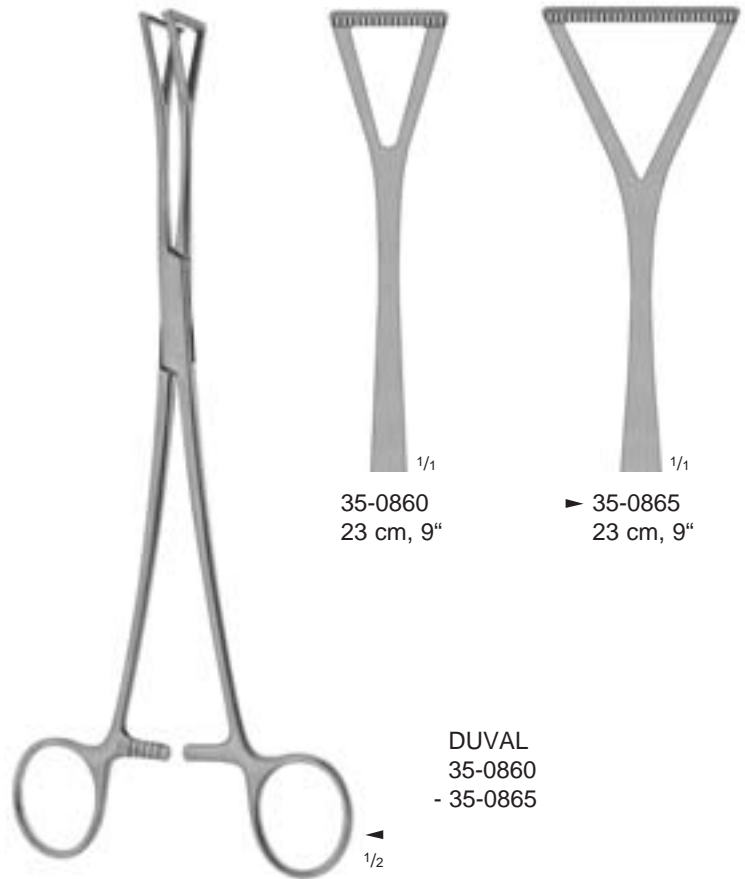
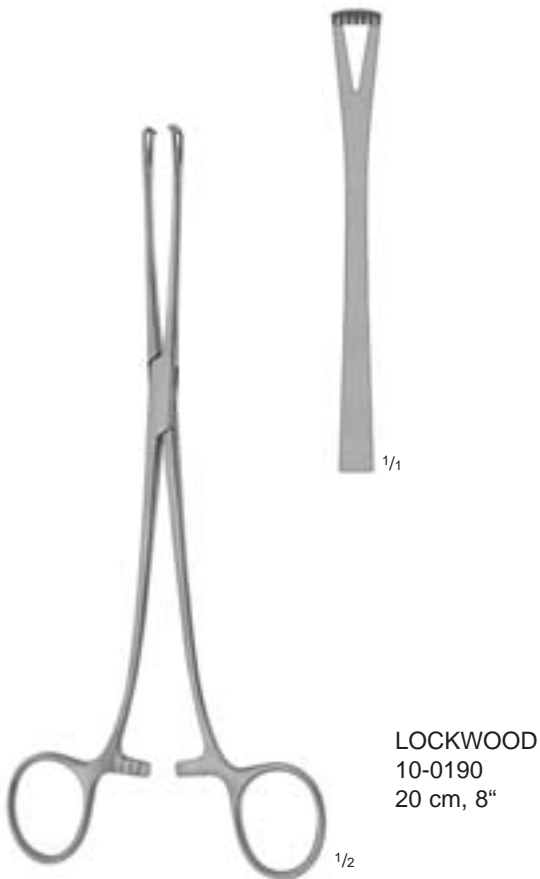
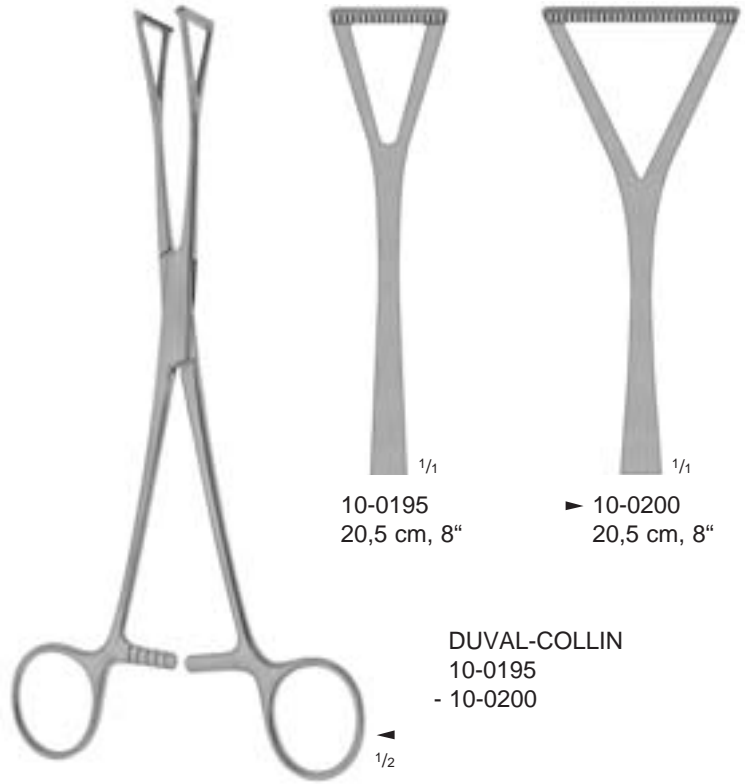
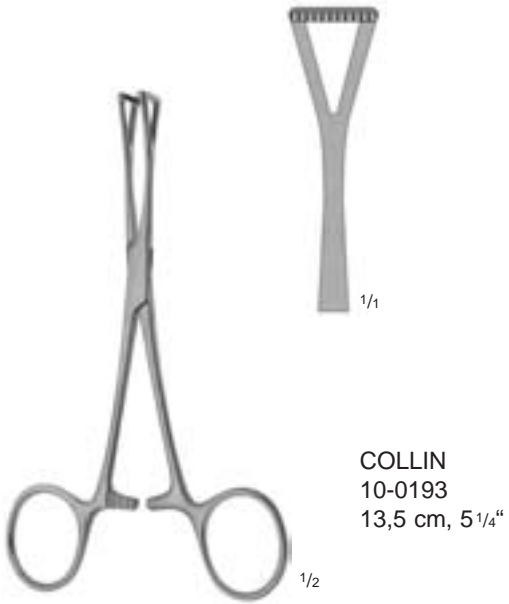



PENNINGTON
 06-0620
 15 cm, 6"

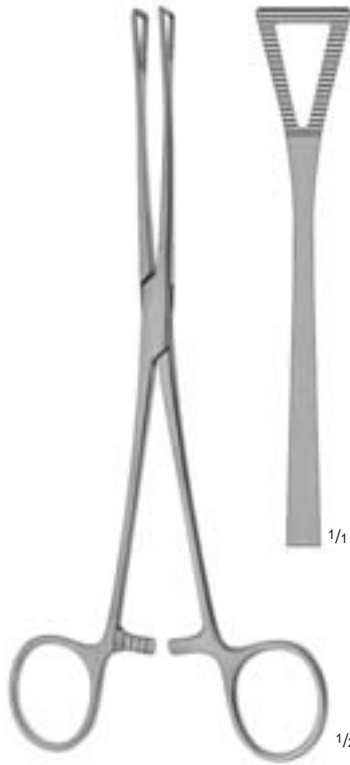

PENNINGTON
 35-0720
 20 cm, 8"

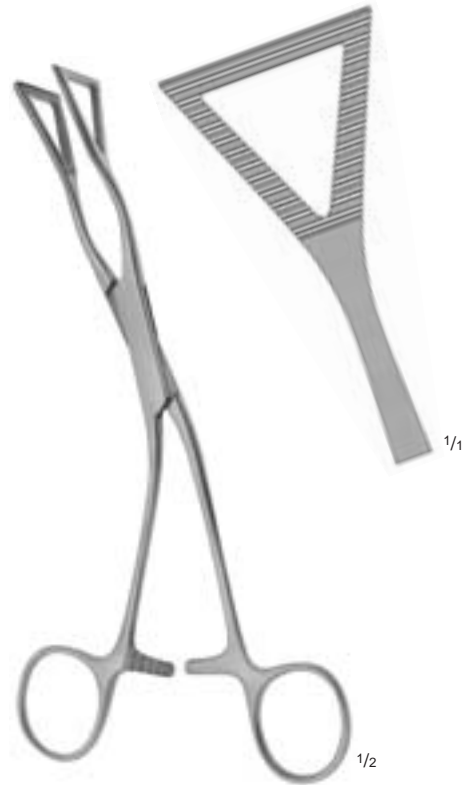

LOVELACE
 11-0480
 19 cm, 7 1/2"

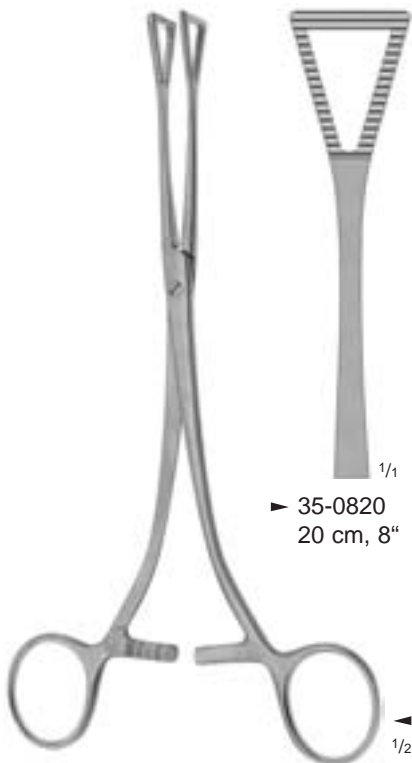

▶ 35-0820
 20 cm, 8"



35-0825
 20 cm, 8"

DUVAL
 35-0820
 - 35-0825

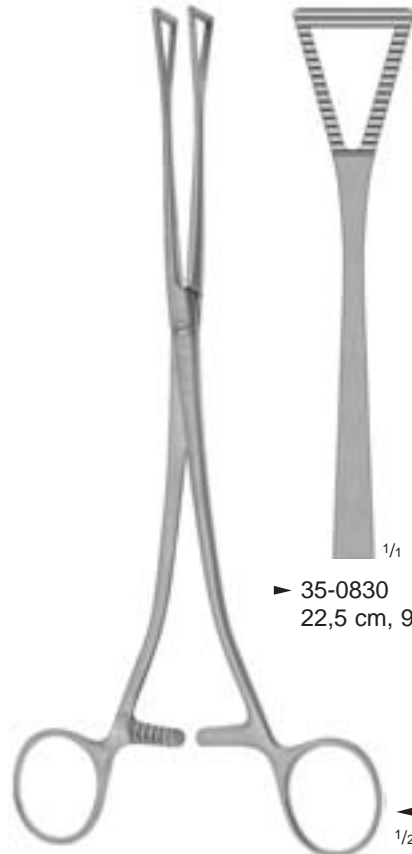

▶ 35-0830
 22,5 cm, 9"



35-0835
 22,5 cm, 9"

DUVAL
 35-0830
 - 35-0835



Darm- und Gewebefaßzangen
 Intestinal and Tissue Grasping Forceps
 Pinzas intestinales y para tejidos
 Pinces à préhension de l'intestin
 Pinze da presa per intestino e tessuti



WILLIAMS
 10-0170
 16 cm, 6 1/4"



DUVAL
 10-1195
 20,5 cm, 8"

mit Hartmetalleinlagen
 with tungsten carbide inserts
 con bocas de carburo tungsteno
 avec mors en tungstène
 con morsi in carburo di tungsteno



10-1146
 16 cm, 6 1/4"



10-1151
 17,5 cm, 7"



▶ 10-1156
 20,5 cm, 8"

BABCOCK
 10-1146
 - 10-1156

mit Hartmetalleinlagen
 with tungsten carbide inserts
 con bocas de carburo tungsteno
 avec mors en tungstène
 con morsi in carburo di tungsteno

ATRAUMATIC-GRIP Darm- und Gewebefaßzangen mit atraumatischer Riefung
 ATRAUMATIC-GRIP Intestinal and Tissue Grasping Forceps with non-traumatic serration
 ATRAUMATIC-GRIP Pinzas intestinales y para tejidos con bocas atraumáticas
 ATRAUMATIC-GRIP Pincès à préhension de l'intestin avec mors atraumatiques
 ATRAUMATIC-GRIP Pinze da presa per intestino e tessuti con presa atraumatica

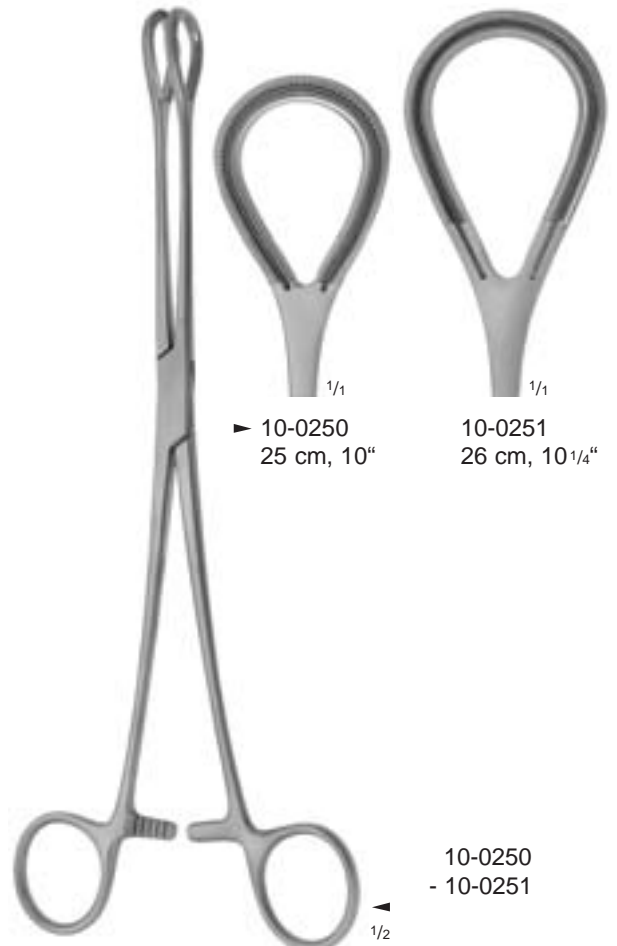
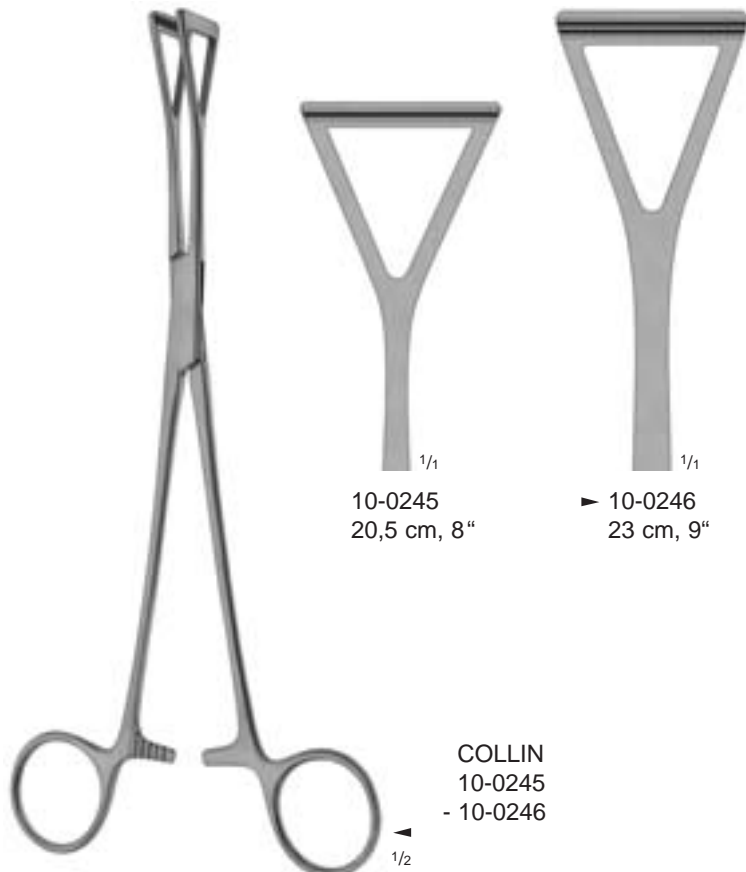
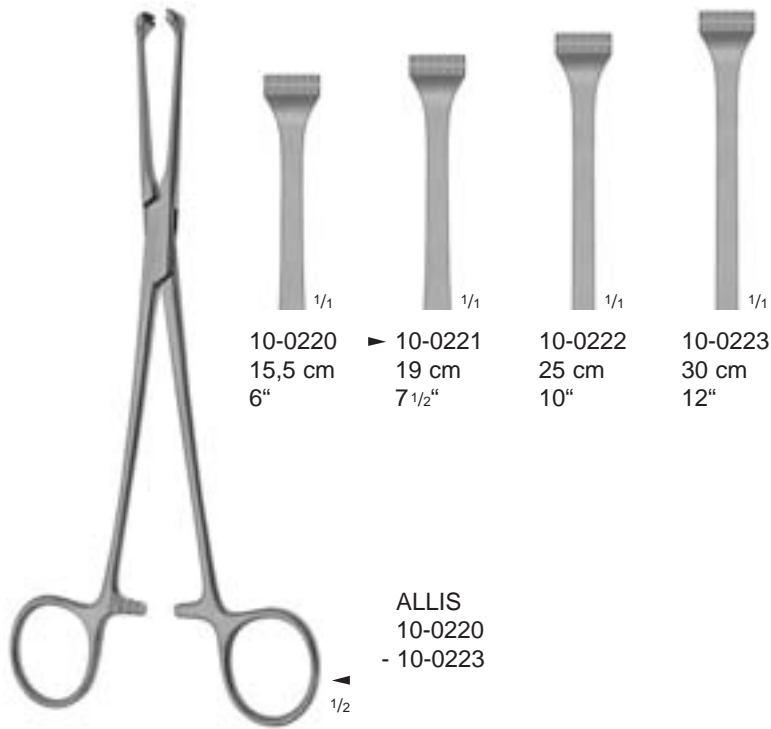



Darmklemmen
 Intestinal Clamp Forceps
 Pinzas-clamps intestinales
 Pincas-clamps intestinales
 Pinze intestinali

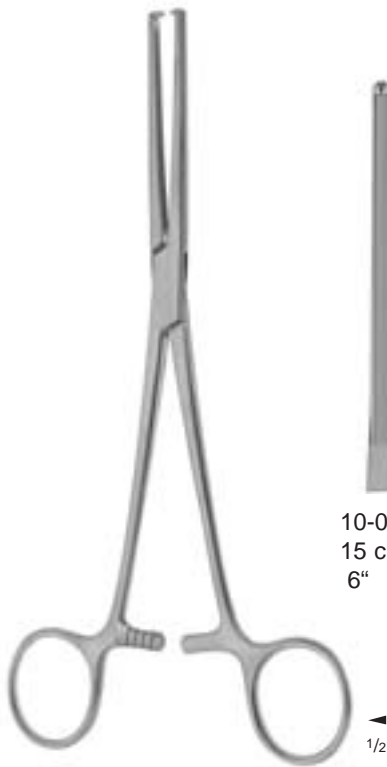

ALLEN
 10-0438
 - 10-0440
 1x2 Zähne
 1x2 teeth
 1x2 dientes
 1x2 dents
 1x2 denti

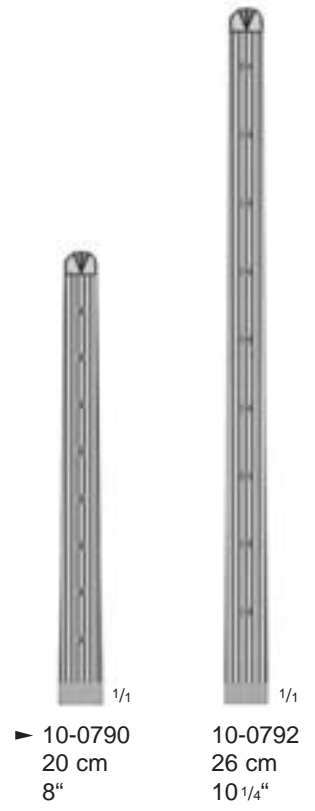

REDO
 10-0790
 - 10-0792
 1x2 Zähne
 1x2 teeth
 1x2 dientes
 1x2 dents
 1x2 denti

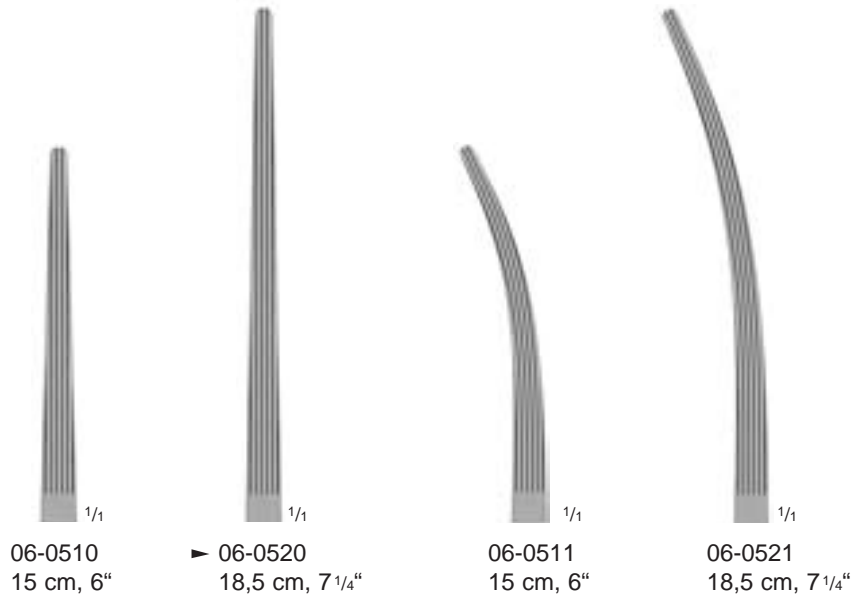

BAINBRIDGE
 06-0510
 - 06-0521

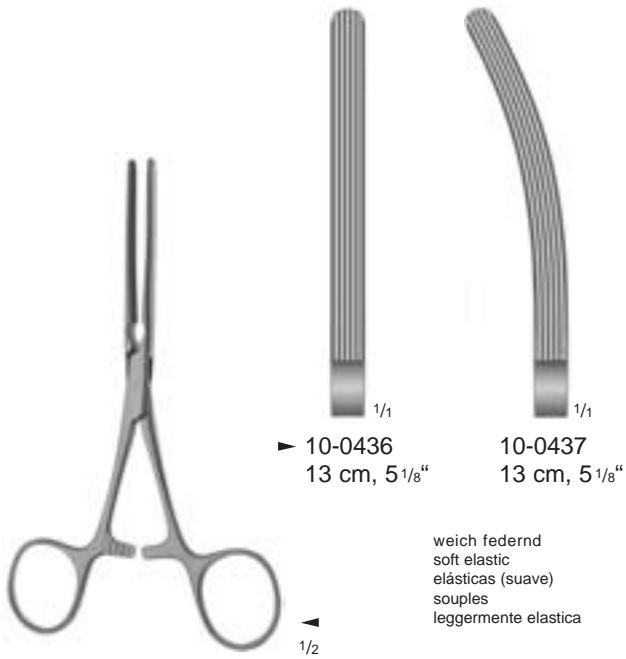

▶ 10-0436 13 cm, 5 1/8"
 ▶ 10-0437 13 cm, 5 1/8"

weich federnd
 soft elastic
 elásticas (suave)
 souples
 leggermente elastica

BABY-KOCHER
 10-0436
 - 10-0437



ATRAUMATIC-GRIP

▶ 10-0442 13 cm, 5 1/8"
 ▶ 10-0443 13 cm, 5 1/8"

weich federnd
 soft elastic
 elásticas (suave)
 souples
 leggermente elastica

BABY-KOCHER
 10-0442
 - 10-0443

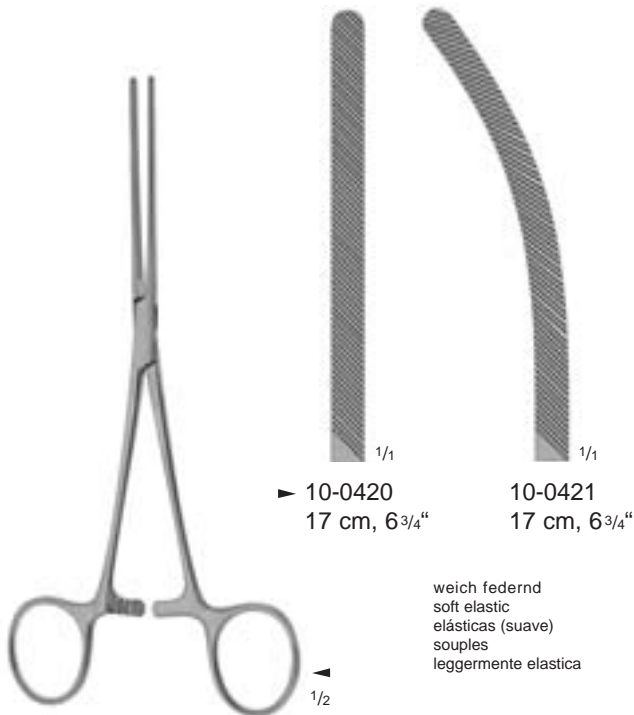

▶ 10-0420 17 cm, 6 3/4"
 ▶ 10-0421 17 cm, 6 3/4"

weich federnd
 soft elastic
 elásticas (suave)
 souples
 leggermente elastica

BABY-DOYEN
 10-0420
 - 10-0421

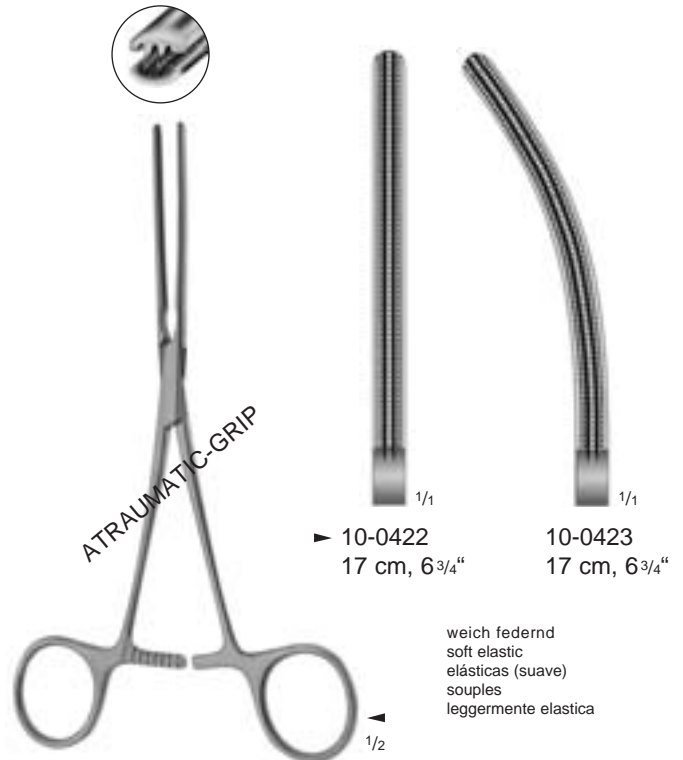

ATRAUMATIC-GRIP

▶ 10-0422 17 cm, 6 3/4"
 ▶ 10-0423 17 cm, 6 3/4"

weich federnd
 soft elastic
 elásticas (suave)
 souples
 leggermente elastica

BABY-DOYEN
 10-0422
 - 10-0423



Darmklemmen
 Intestinal Clamp Forceps
 Pinzas-clamps intestinales
 Pincas-clamps intestinales
 Pinze intestinali

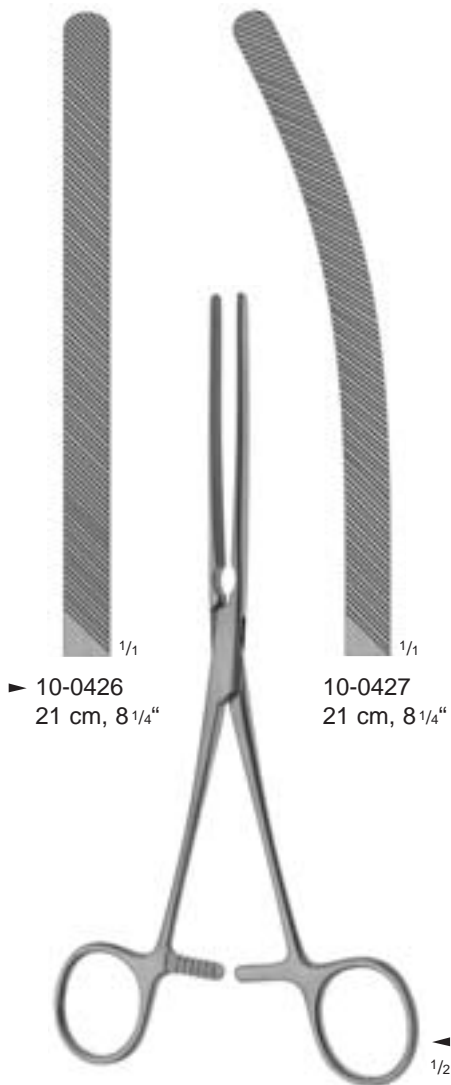

► 10-0426
 21 cm, 8 1/4"

10-0427
 21 cm, 8 1/4"

DOYEN
 10-0426
 - 10-0427

weich federnd
 soft elastic
 elásticas (suave)
 souples
 leggermente elastica

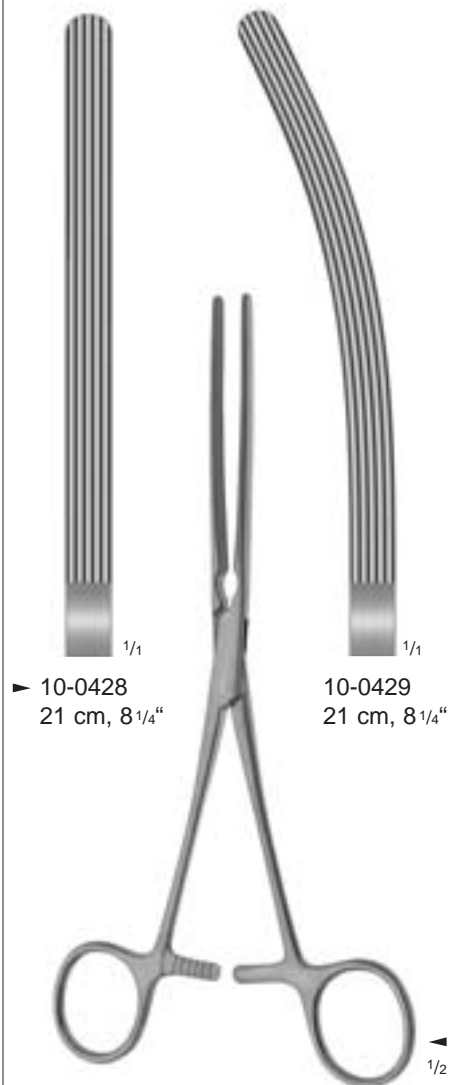

► 10-0428
 21 cm, 8 1/4"

10-0429
 21 cm, 8 1/4"

KOCHER
 10-0428
 - 10-0429

weich federnd
 soft elastic
 elásticas (suave)
 souples
 leggermente elastica

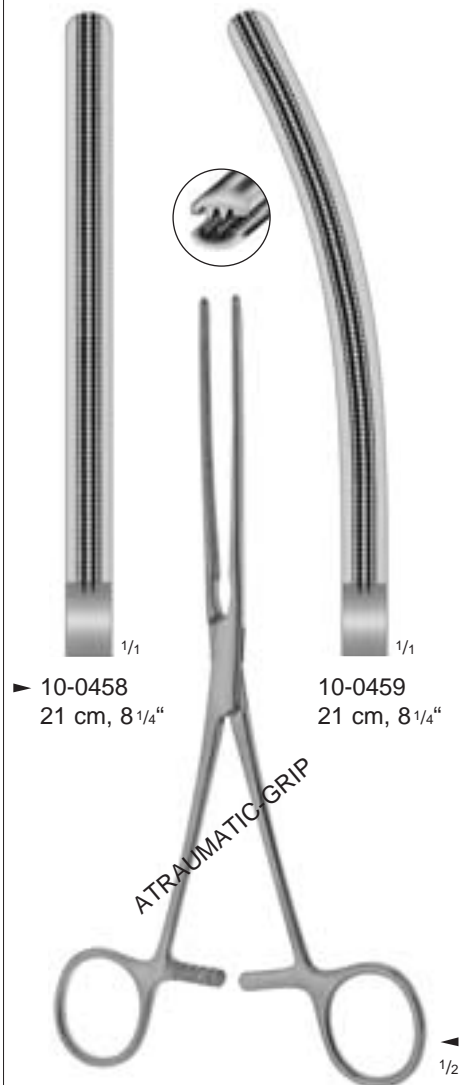

► 10-0458
 21 cm, 8 1/4"

10-0459
 21 cm, 8 1/4"

DOYEN
 10-0458
 - 10-0459

weich federnd
 soft elastic
 elásticas (suave)
 souples
 leggermente elastica

mit atraumatischer Riefung
 with non-traumatic serration
 con bocas atraumáticas
 avec mors atrauma
 con morsi atraumatici

ATRAUMATIC GRIP

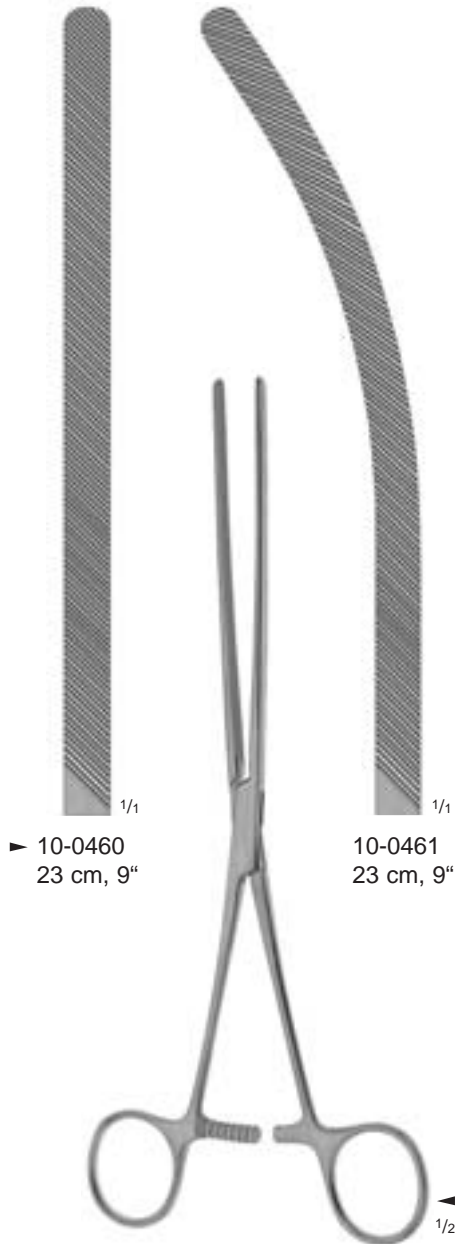

▶ 10-0460
23 cm, 9"

10-0461
23 cm, 9"

DOYEN
10-0460
- 10-0461

weich federnd
soft elastic
elásticas (suave)
souples
leggermente elastica

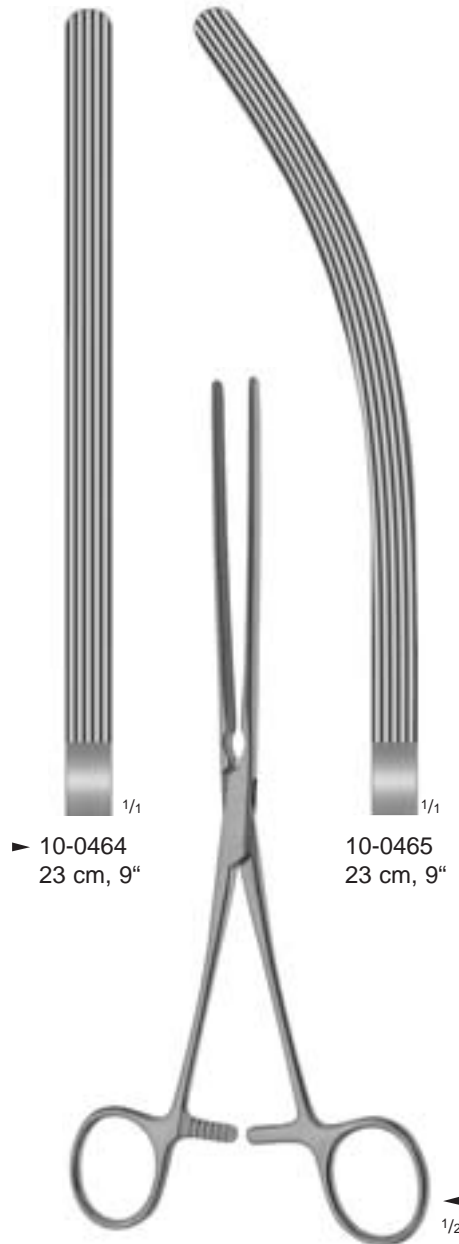

▶ 10-0464
23 cm, 9"

10-0465
23 cm, 9"

KOCHER
10-0464
- 10-0465

weich federnd
soft elastic
elásticas (suave)
souples
leggermente elastica

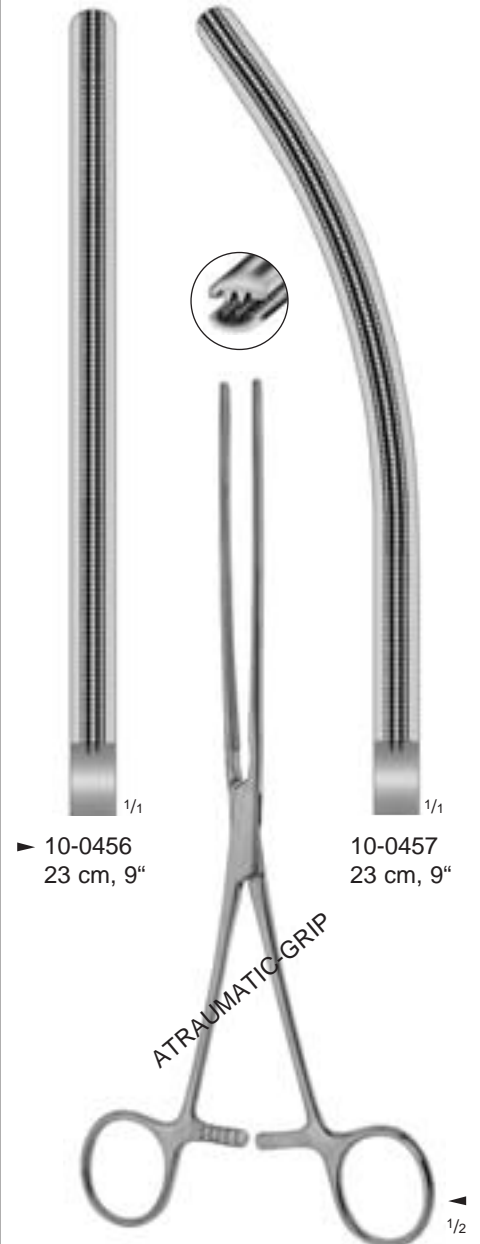

mit atraumatischer Riefung
with non-traumatic serration
con bocas atraumáticas
avec mors atrauma
con morsi atraumatici

▶ 10-0456
23 cm, 9"

10-0457
23 cm, 9"

ATRAUMATIC GRIP

DOYEN
10-0456
- 10-0457

weich federnd
soft elastic
elásticas (suave)
souples
leggermente elastica



Darmklemmen
Intestinal Clamp Forceps
Pinzas-clamps intestinales
Pinces-clamps intestinales
Pinze intestinali

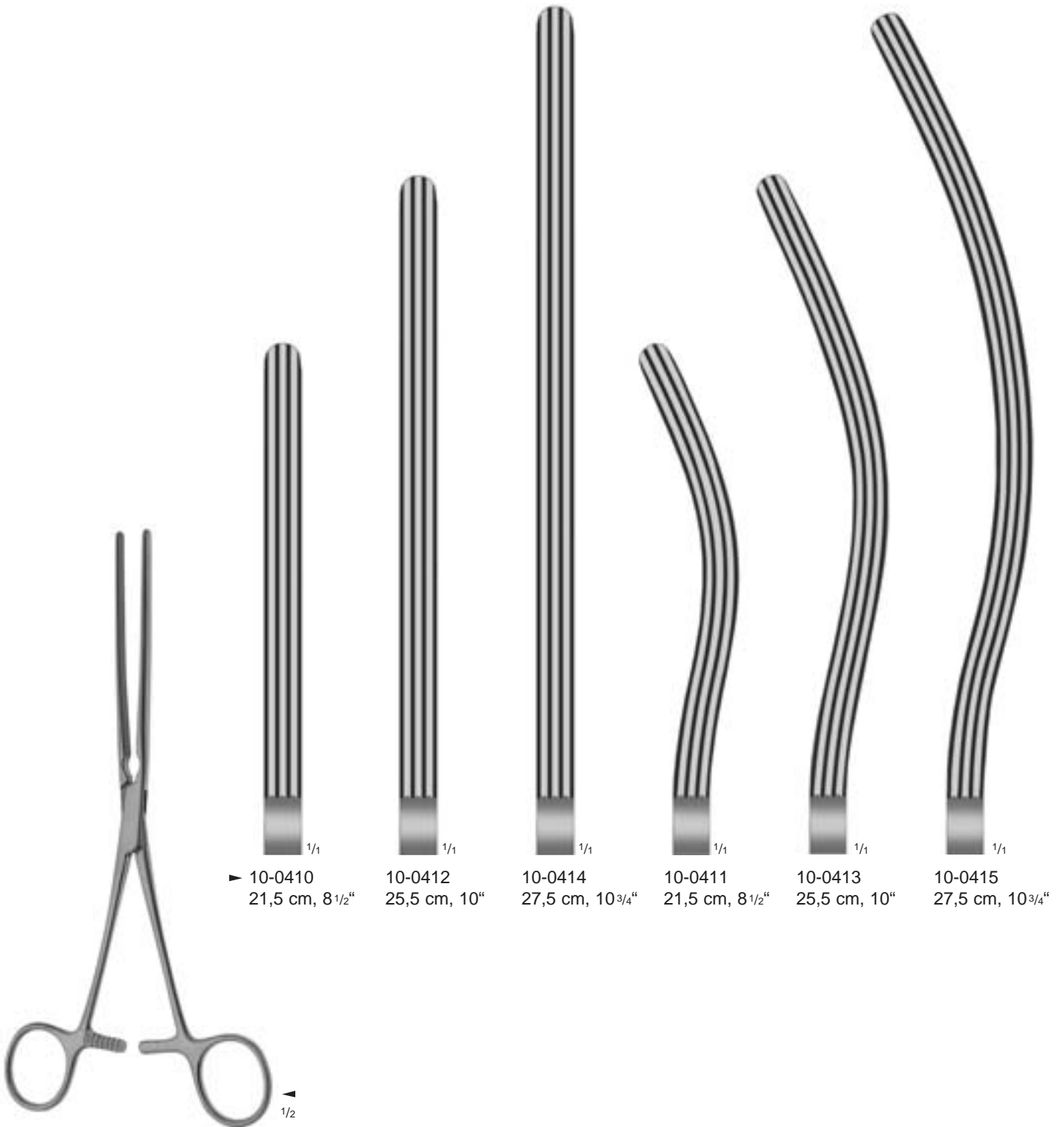

▶ 10-0410
21,5 cm, 8 1/2"

10-0412
25,5 cm, 10"

10-0414
27,5 cm, 10 3/4"

10-0411
21,5 cm, 8 1/2"

10-0413
25,5 cm, 10"

10-0415
27,5 cm, 10 3/4"

KOCHER

10-0410

- 10-0415

weich federnd
soft elastic
elásticas (suave)
souples
leggermente elastica

ATRAUMATIC-GRIP Darmklemmen mit atraumatischer Riefung
 ATRAUMATIC-GRIP Intestinal Clamp Forceps with non-traumatic serration
 ATRAUMATIC-GRIP Pinzas-clamps intestinales con bocas atraumáticas
 ATRAUMATIC-GRIP Pincas-clamps intestinales avec mors atraumatiques
 ATRAUMATIC-GRIP Pinze intestinali con presa atraumatica

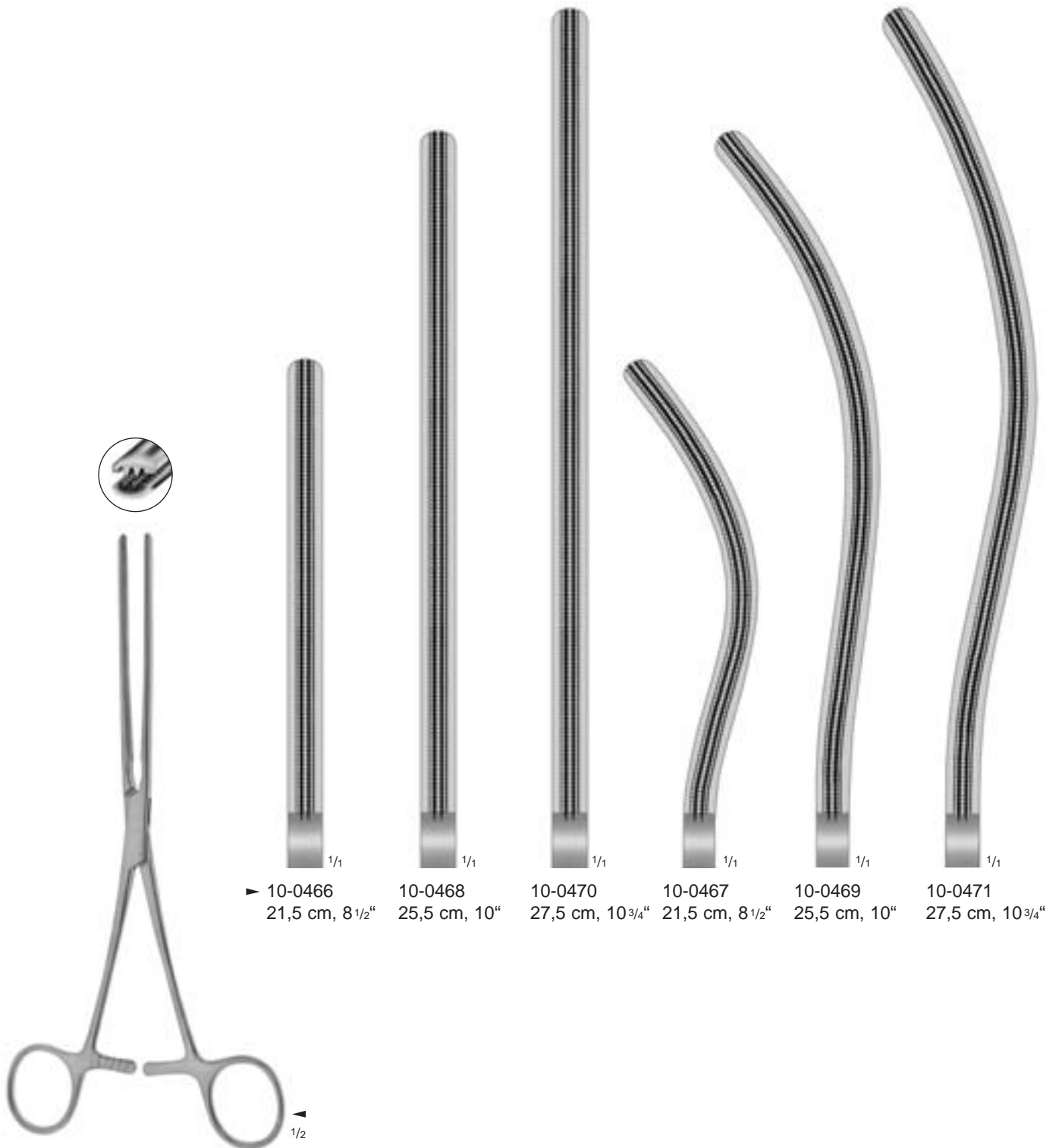

| | | | | | |
|-----------------|--------------|------------------|-----------------|--------------|------------------|
| ▶ 10-0466 | 10-0468 | 10-0470 | 10-0467 | 10-0469 | 10-0471 |
| 21,5 cm, 8 1/2" | 25,5 cm, 10" | 27,5 cm, 10 3/4" | 21,5 cm, 8 1/2" | 25,5 cm, 10" | 27,5 cm, 10 3/4" |

KOCHER
 10-0466
 - 10-0471

weich federnd
 soft elastic
 elásticas (suave)
 souples
 leggermente elastica



Darmklemmen
Intestinal Clamp Forceps
Pinzas-clamps intestinales
Pincas-clamps intestinales
Pinze intestinali

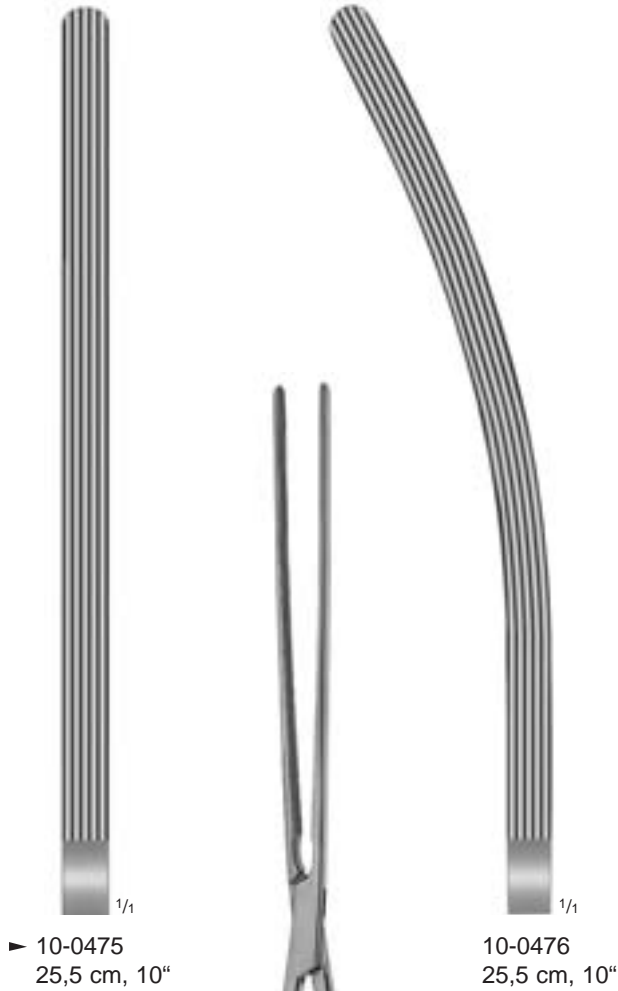

MAYO-ROBSON
10-0475
- 10-0476

hart federnd
hard elastic
elásticas (duro)
fermes
elastica duro



MAYO-ROBSON
10-0482
- 10-0483

hart federnd, mit atraumatischer Riefung
hard elastic, with non-traumatic serration
elásticas (duro), con bocas atraumáticas
fermes, avec mors atrauma
elastica duro, con morsi atraumatici

ATRAUMATIC-GRIP Magenklammen mit atraumatischer Riefung
 ATRAUMATIC-GRIP Stomach Clamp Forceps with non-traumatic serration
 ATRAUMATIC-GRIP Pinzas-clamps estomacales con bocas atraumáticas
 ATRAUMATIC-GRIP Pincers-clamps stomacales avec mors atraumatiques
 ATRAUMATIC-GRIP Pinze per stomaco con presa atraumatica



▶ 10-0488
 33 cm, 13"

10-0489
 33 cm, 13"

SCUDDER
 10-0488
 - 10-0489



- ATRAUMATIC-GRIP Obere Verschlussklemme mit atraumatischer Riefung
- ATRAUMATIC-GRIP Upper Occlusive Clamp with non-traumatic serration
- ATRAUMATIC-GRIP Pinza-clamp oclusiva superior con bocas atraumáticas
- ATRAUMATIC-GRIP Pincers-clamps à occlusion avec mors atraumatiques
- ATRAUMATIC-GRIP Pinza-clamp per occlusione superiore del retto con presa atraumatica

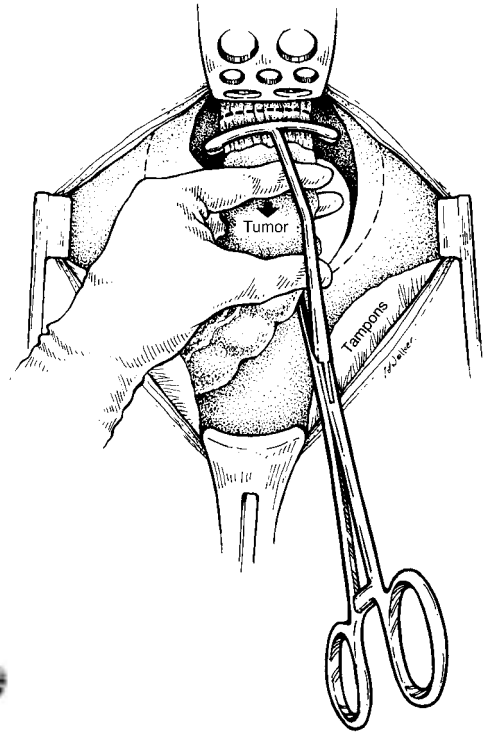

THORLAKSON
10-0660
29 cm, 11 1/2"

zur Verwendung bei der vorderen Rektumresektion
for use in anterior resection of the rectum
para el uso de la resección anterior del recto
utilisé pour la résection antérieure du rectum
per la resezione anteriore del retto

ATRAUMATIC-GRIP Untere Verschlussklemmen mit atraumatischer Riefung
 ATRAUMATIC-GRIP Lower Occlusive Clamps with non-traumatic serration
 ATRAUMATIC-GRIP Pinzas-clamps oclusiva inferior con bocas atraumáticas
 ATRAUMATIC-GRIP Pincas-clamps à occlusion avec mors atraumatiques
 ATRAUMATIC-GRIP Pinza-clamp per occlusione inferiore del retto con presa atraumatica

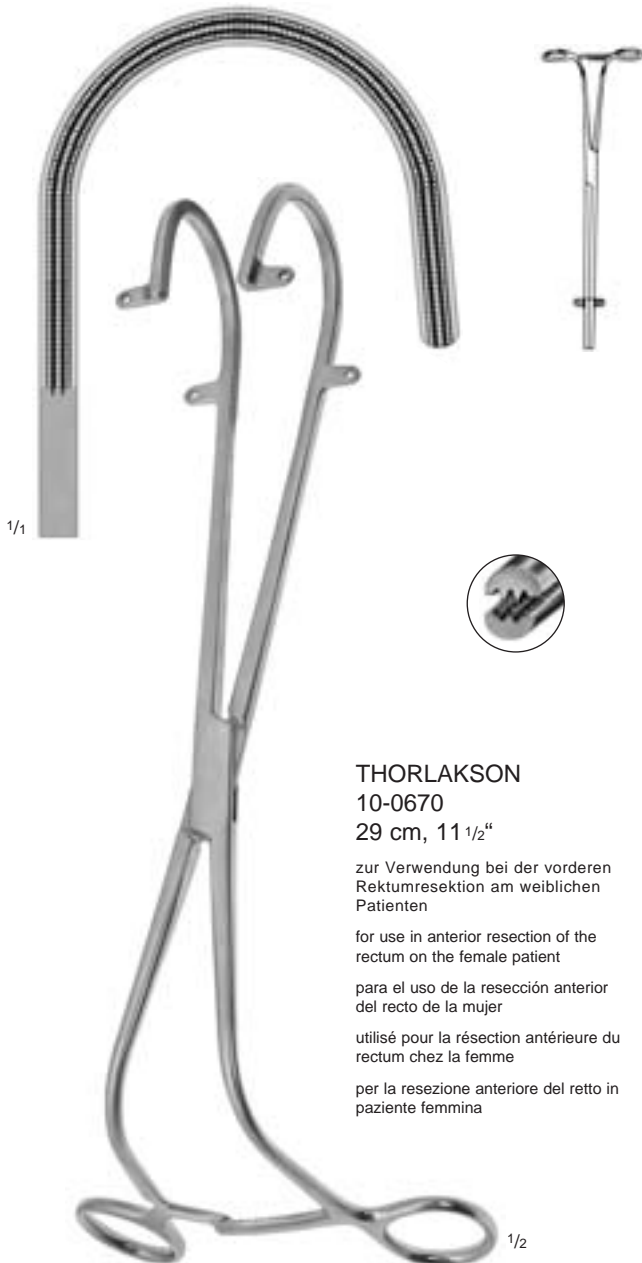
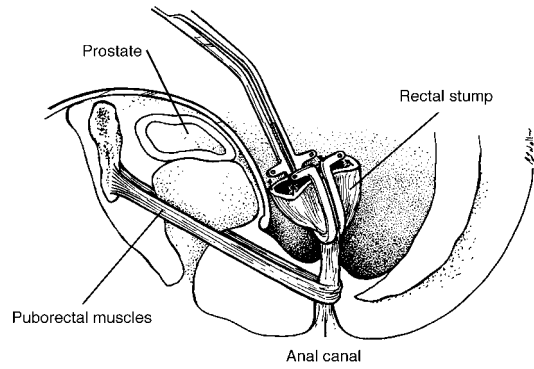
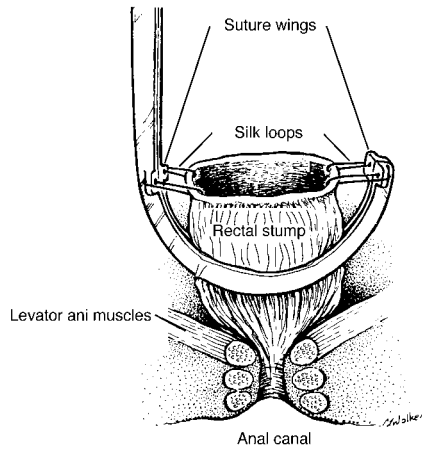

THORLAKSON
 10-0670
 29 cm, 11 1/2"

zur Verwendung bei der vorderen Rektumresektion am weiblichen Patienten

for use in anterior resection of the rectum on the female patient

para el uso de la resección anterior del recto de la mujer

utilisé pour la résection antérieure du rectum chez la femme

per la resezione anteriore del retto in paziente femmina

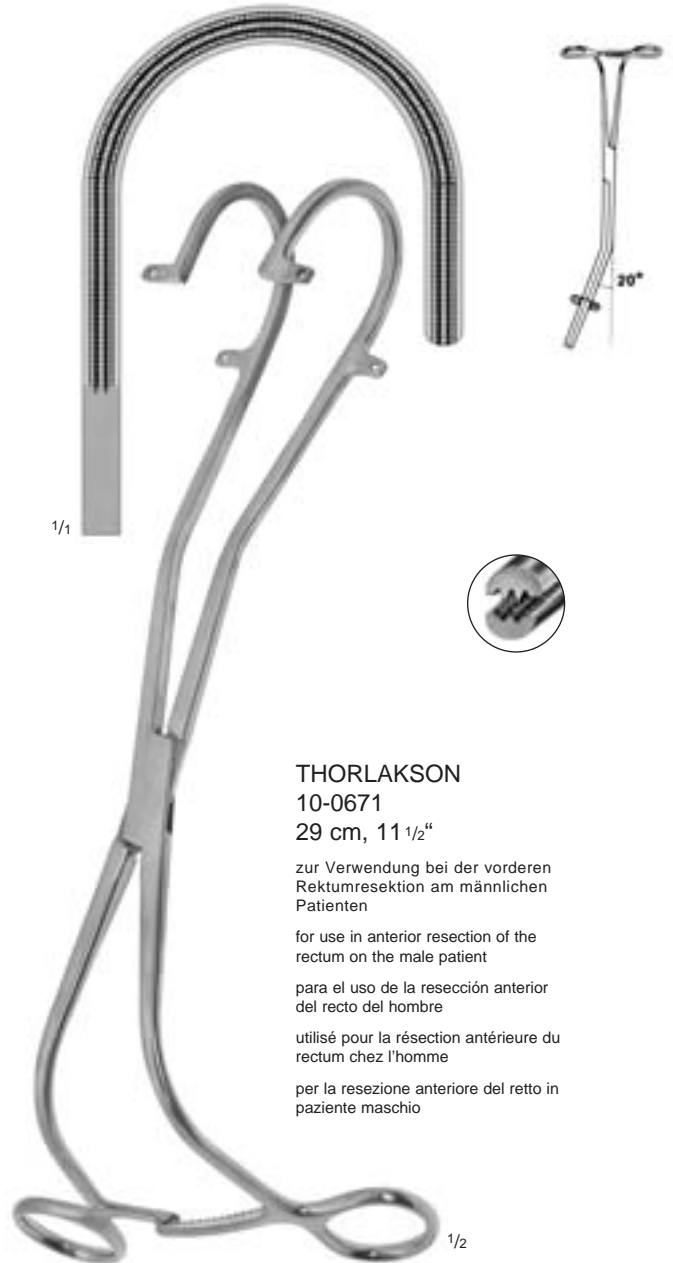

THORLAKSON
 10-0671
 29 cm, 11 1/2"

zur Verwendung bei der vorderen Rektumresektion am männlichen Patienten

for use in anterior resection of the rectum on the male patient

para el uso de la resección anterior del recto del hombre

utilisé pour la résection antérieure du rectum chez l'homme

per la resezione anteriore del retto in paziente maschio



Rektum-Anastomosenklemmen
 Sigmoid Anastomosis Forceps
 Pinzas para anastomosis del recto
 Pincers-clamps à anastomose du rectum
 Pinze per anastomosi del retto

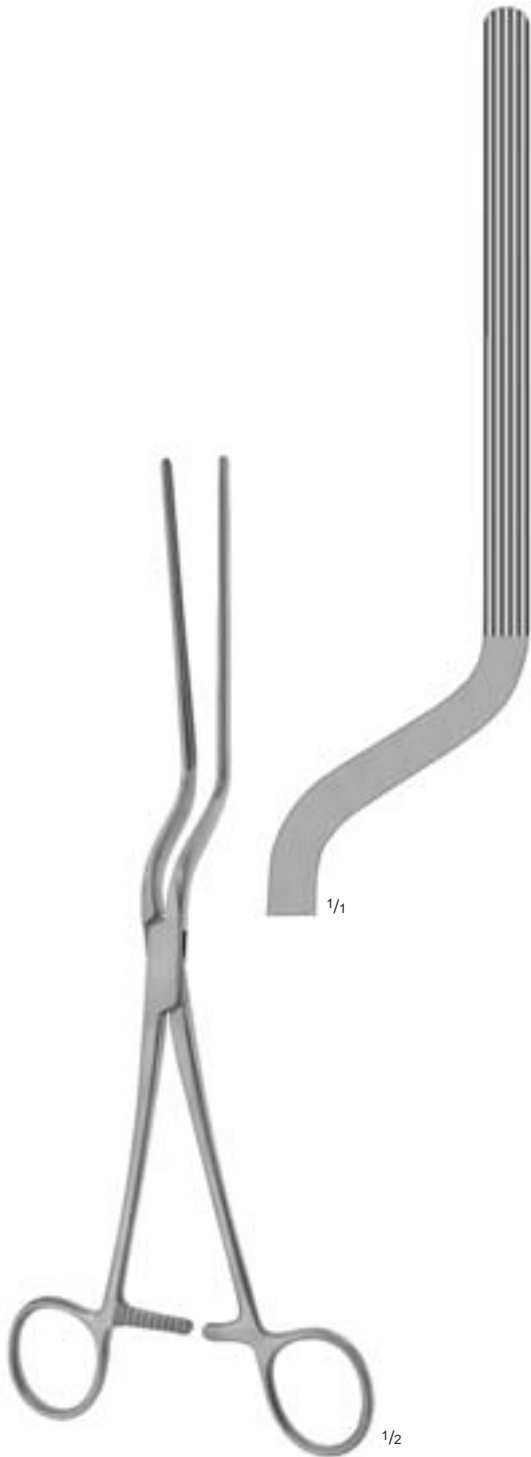

BRUNNER
 10-0490
 26,5 cm, 10 1/2"

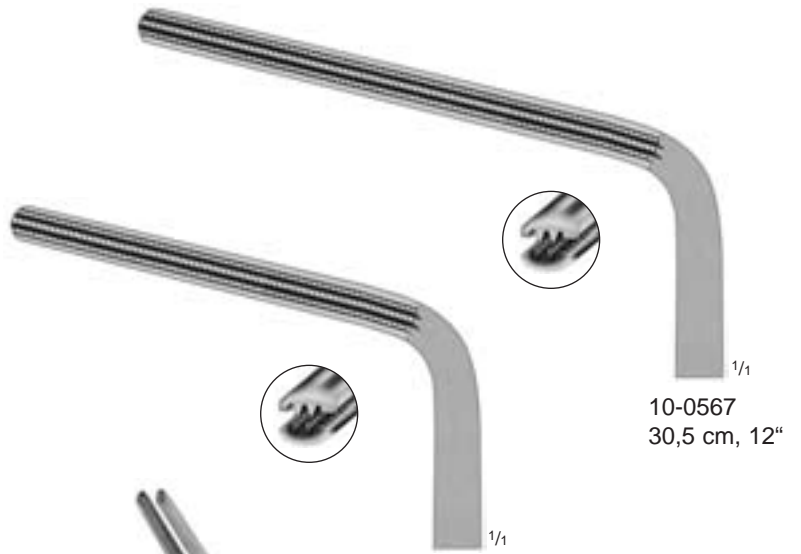

► 10-0566
 30 cm, 12"

10-0567
 30,5 cm, 12"

mit atraumatischer Riefung
 with non-traumatic serration
 con bocas atraumáticas
 avec mors atrauma
 con morsi atraumatici

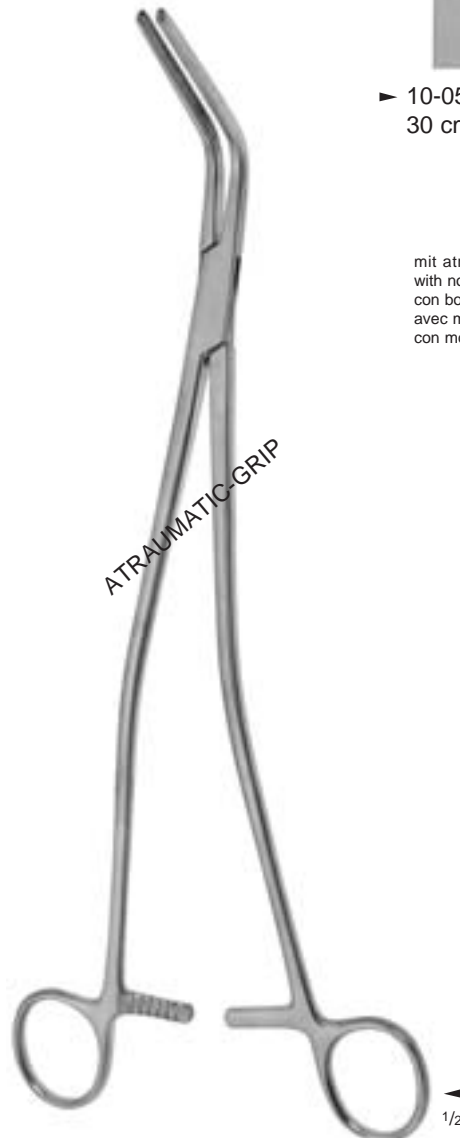

HAYES
 10-0566
 - 10-0567

ATRAUMATIC-GRIP Rektum-Anastomosenklemmen mit atraumatischer Riefung
 ATRAUMATIC-GRIP Sigmoid Anastomosis Forceps with non-traumatic serration
 ATRAUMATIC-GRIP Pinzas para anastomosis de recto con bocas atraumáticas
 ATRAUMATIC-GRIP Pincers clamps à anastomose du rectum avec mors atraumatiques
 ATRAUMATIC-GRIP Pinze per anastomosi de retto con presa atraumatica

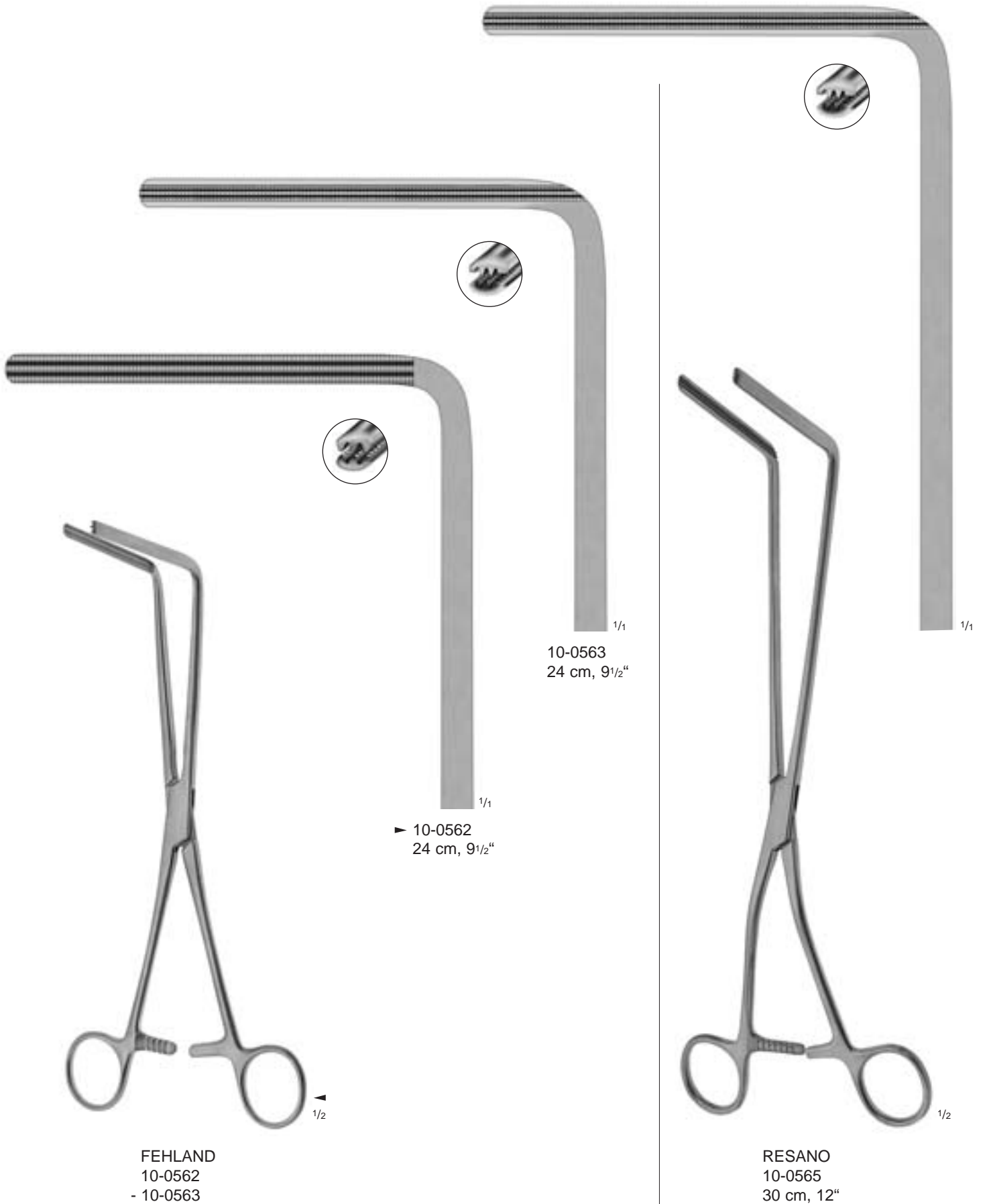



Darm- und Anastomosenklemmen
 Intestinal and Anastomosis Clamp Forceps
 Pinzas-clamps intestinales y para anastomosis
 Pinces-clamps intestinales et à anastomose
 Pinze intestinali e per anastomosi



DE MARTEL-WOLFSON

10-0622

Dickdarm-Anastomosen-Klemmen, Maullänge 60 mm, Satz zu 3 Stück

Colon-anastomosis clamp forceps, 60 mm length of jaws, set of 3 pieces

Clamps para anastomosis del colon, longitud de la boca 60 mm, juego de 3 piezas

Clamps pour anastomose du colon, mors de 60 mm, jeu de 3 pieces

Pinze per anastomosi del colon, bocche lungh. 60 mm., set 3 pezzi

▶ 10-0623

Dickdarm-Anastomosen-Klemmen, Maullänge 75 mm, Satz zu 3 Stück

Colon-anastomosis clamp forceps, 75 mm length of jaws, set of 3 pieces

Clamps para anastomosis del colon, longitud de la boca 75 mm, juego de 3 piezas

Clamps pour anastomose du colon, mors de 75 mm, jeu de 3 pieces

Pinze per anastomosi del colon, bocche lungh. 75 mm., set 3 pezzi

10-0624

Dickdarm-Anastomosen-Klemmen, Maullänge 105 mm, Satz zu 3 Stück

Colon-anastomosis clamp forceps, 105 mm length of jaws, set of 3 pieces

Clamps para anastomosis del colon, longitud de la boca 105 mm, juego de 3 piezas

Clamps pour anastomose du colon, mors de 105 mm, jeu de 3 pieces

Pinze per anastomosi del colon, bocche lungh. 105 mm., set 3 pezzi



DE MARTEL-WOLFSON
 10-0625
 9 cm, 3 1/2"

Klemmenhalter, kurz
 Clamp holder, short
 Porta-clamp, corto
 Porte-clamps, court
 Portapinze, corto

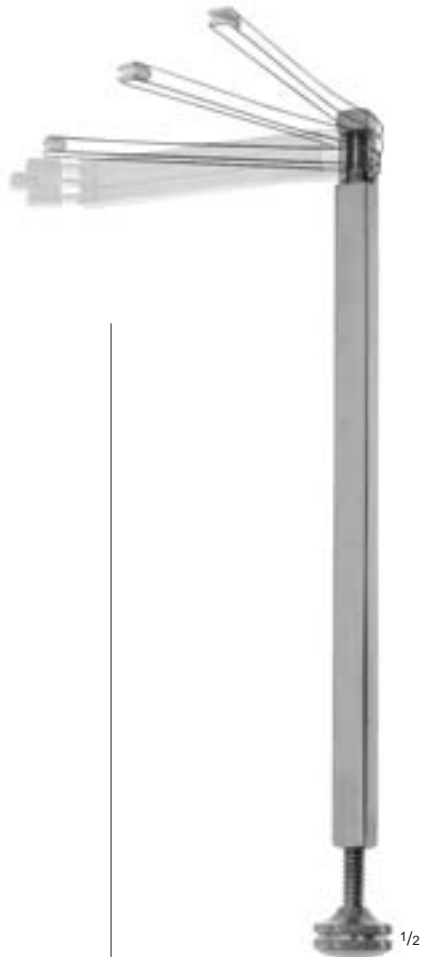

DE MARTEL-WOLFSON
 10-0630
 22,5 cm, 9"

Klemmenhalter, lang
 Clamp holder, long
 Porta-clamp, largo
 Porte-clamps, long
 Portapinze, lungo



DE MARTEL-WOLFSON
 10-0640
 24,5 cm, 9 3/4"

Klemmschließzange
 Clamp closing forceps
 Pinza para cerrar los clamps
 Pince pour fermer les clamps
 Serrapinze

Spornquetsche
 Spur Crusher
 Machacadora para espora
 Ecraseurs intestinaux
 Pinza schiaccia sperone

Pylorusspreizer
 Pylorus Spreader
 Separador para píloro
 Ecarteur du pylore
 Divaricatore per píloro

Darm- und Magenquetschklemmen
 Intestinal and Stomach Clamps
 Pinzas-clamps intestinales y estomacales
 Pincés-clamps pour l'intestin et l'estomac
 Pinze/clamp per intestino e stomaco



KLEINSCHMIDT
 10-0648
 12,5 cm, 5"

Spornquetsche und Appendektomieklammer
 Spur crusher and appendectomy clamp
 Machacadora para espora y clamp para apendectomía
 Ecraseur et clamp à appendicectomie
 Pinza schiaccia sperone e clamp per appendicectomia



BENSON
 10-0168
 15,5 cm, 6"

Pylorusspreizer
 Pylorus spreader
 Separador para píloro
 Ecarteur du pylore
 Divaricatore per píloro



BABY-PAYR
 10-0849
 15,5 cm, 6"

Darm- und Magenquetschklemme mit Stift
 Intestinal and stomach clamp with pin
 Pinza-clamp intestinales y estomacales con espiga
 Pince-clamp et écraseurs pour l'intestin et l'estomac avec pointe
 Clamp per intestino e stomaco con perno

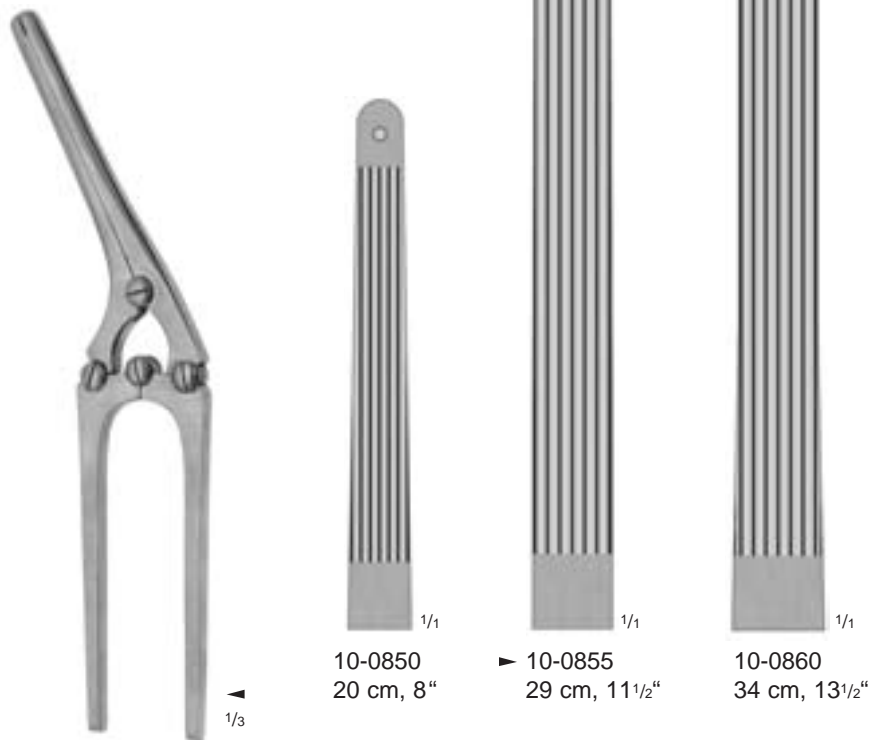

PAYR
 10-0850
 - 10-0860

Darm- und Magenquetschklemmen mit Stift
 Intestinal and stomach clamps with pin
 Pinzas-clamps intestinales y estomacales con espiga
 Pincés-clamps et écraseurs pour l'intestin et l'estomac avec pointe
 Clamp per intestino e stomaco con perno

10-0850
 20 cm, 8"

▶ 10-0855
 29 cm, 11 1/2"

10-0860
 34 cm, 13 1/2"



Magen- und Darm-Nähapparat
Stomach and Intestinal Suturing Apparatus
Aparato para suturar estomacal e intestinal
Appareil à suture gastro-intestinale
Apparecchiatura di sutura gastro-intestinale

VON PETZ
10-0700

Magen- und Darm-Nähapparat, komplett, bestehend aus:

- 10-0702 1 Nähapparat für 23 Paar Nähklammern
- 10-0711 1 Füllpinzette
- 10-0712 1 Füllstift
- 10-0713 1 Füllständer
- 10-0714 1 Zusatzschloß
- 10-0715 1 Kurbel
- 10-0716 1 Schraubenzieher
- 10-0717 1 Metalletui für Klammern
- 10-0710 1 Packung mit 300 Stück Nähklammern aus Neusilber
- 10-0718 1 Holzetui 460 x 200 x 55 mm

Stomach and intestinal suturing apparatus, complete, consisting of:

- 10-0702 1 Suturing apparatus for 23 pairs of suturing clips
- 10-0711 1 Filling tweezer
- 10-0712 1 Filling pin
- 10-0713 1 Filling rack
- 10-0714 1 Additional closing clamp
- 10-0715 1 Gear wheel
- 10-0716 1 Screw driver
- 10-0717 1 Metal box for clips
- 10-0710 1 Package containing 300 pieces suture clips of German silver
- 10-0718 1 Wooden case 460 x 200 x 55 mm



1/4

Aparato para suturar estomacal e intestinal, completo, compuesto de:

- 10-0702 1 Aparato para suturar para 23 pares de agrafes para suturar
- 10-0711 1 Pinza para rellenar
- 10-0712 1 Espiga para rellenar
- 10-0713 1 Estante para rellenar
- 10-0714 1 Cierre adicional
- 10-0715 1 Manivela
- 10-0716 1 Destornillador
- 10-0717 1 Estuche de metal para agrafes
- 10-0710 1 Paquetito de 300 piezas agrafes para suturar de plata alemana
- 10-0718 1 Estuche de madera 460 x 200 x 55 mm

Appareil pour la suture gastro-intestinale, complet, composé de:

- 10-0702 1 Appareil à suture pour 23 paires d'agrafes
- 10-0711 1 Pince à préhension les agrafes
- 10-0712 1 Broche pour fixer les agrafes
- 10-0713 1 Support
- 10-0714 1 Clamp de serrage
- 10-0715 1 Manivelle
- 10-0716 1 Tournevis
- 10-0717 1 Boîte métal pour les agrafes
- 10-0710 1 paquet de 300 agrafes à suture en argent blanc
- 10-0718 1 Boîte en bois 460 x 200 x 55 mm

Apparecchiatura per la sutura gastro-intestinale, completo, composto da:

- 10-0702 1 Apparecchiatura per la sutura per 23 paia di agrafes
- 10-0711 1 Pinza per caricare
- 10-0712 1 Perno per posizionare le agrafe
- 10-0713 1 Supporto per caricare
- 10-0714 1 Clamp supplementare
- 10-0715 1 Manovella
- 10-0716 1 Cacciavite
- 10-0717 1 Scatola in metallo per agrafe
- 10-0710 1 Pacchetto da 300 pezzi agrafe in argento bianco
- 10-0718 1 Astuccio in legno 460 x 200 x 55 mm

VON PETZ
10-0701

Magen- und Darm-Nähapparat, komplett, jedoch ohne Holzetui

Stomach and intestinal suturing apparatus, complete, without wooden case

Aparato para suturar estomacal e intestinal, completo, sin estuche de madera

Appareil pour la suture gastro-intestinale, complet, sans boîte en bois

Apparecchiatura per la sutura gastro-intestinale, completo, senza l'astuccio in legno



1/1



1/2

10-0710

Nähklammern aus Neusilber, Packung mit 300 Stück
Suture clips of German silver, package of 300 pieces
Agrafes para suturar de plata alemana, paquetito de 300 piezas
Agrafes en argent blanc, pour la suture gastro-intestinale, boîtes de 300
Agrafe in argento bianco per sutura gastro-intestinale, pacchetto da 300 pezzi

Mastdarm-Rektum-Spekula
 Rectal Specula
 Espécules para el recto
 Spéculums rectaux
 Speculi rectali

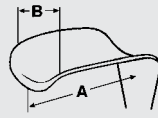

105 x 23-28 mm
 (AxB)

CZERNY
 90-0276
 22,5 cm, 9"

1/2

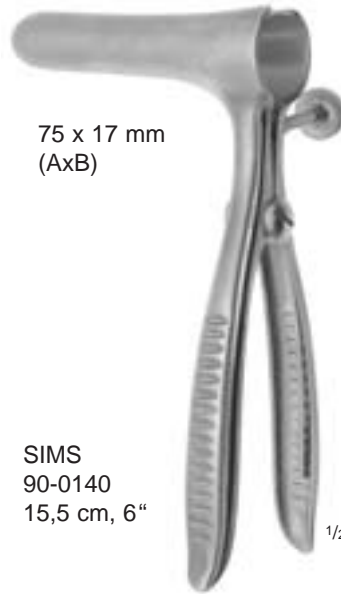

75 x 17 mm
 (AxB)

SIMS
 90-0140
 15,5 cm, 6"

1/2

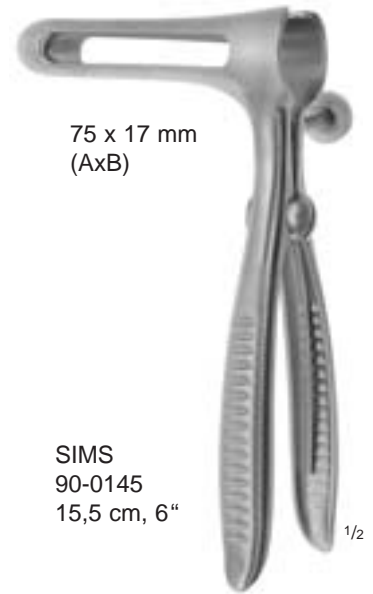

75 x 17 mm
 (AxB)

SIMS
 90-0145
 15,5 cm, 6"

1/2



80 x 25 mm
 (AxB)

PRATT
 90-0130
 20,5 cm, 8"

1/2



90 x 16 mm
 (AxB)

MATHIEU
 90-0138
 19,5 cm, 7³/₄"

1/2



Mastdarm-Rektum-Spekula
Rectal Specula
Espéculos para el recto
Spéculums rectaux
Speculi rectali

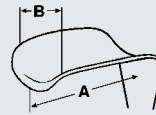

60 x 20 mm
(AxB)

SIMS
90-0147
18 cm, 7"

1/2



90-0148 80 x 25 mm (AxB)
▶ 90-0149 125 x 25 mm (AxB)
90-0155 150 x 25 mm (AxB)

SIMS
90-0148
- 90-0155
24,5 cm, 9 3/4"

1/2

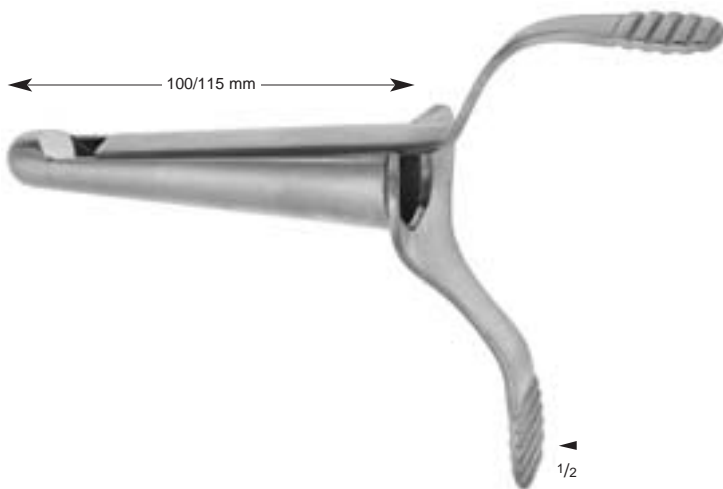

100/115 mm

BRINKERHOFF

▶ 90-0205 ø 15-25 mm x 100 mm
90-0210 ø 19-31 mm x 115 mm

1/2

Sphinkteroskope
Sphincteroscopes
Esfinteroscopios
Sphinctérosopes
Sfinteroscopi

Anuskope
Anoscopes
Anoscopios
Anuscopes
Anoscopi

Analspreizer
Rectal Retractor
Separador para el recto
Dilatateurs pour anus et rectum
Dilatatori per l'ano ed il retto



KELLY

- ▶ 90-0150 ø 21 mm x 50 mm
- ▶ 90-0151 ø 27 mm x 50 mm

Sphinkteroskope
Sphincteroscopes
Esfinteroscopios
Sphinctérosopes
Sfinteroscopi



HIRSCHMANN

- ▶ 90-0225 ø 19 mm x 65 mm
- ▶ 90-0230 ø 22 mm x 65 mm

Anuskope
Anoscopes
Anoscopios
Anuscopes
Anoscopi



IVES-FANSLER

- ▶ 90-0180
- ø 22 mm x 80 mm

Anoskop mit Hartgummi-Obturator
Anoscope with vulcanite obturator
Anoscopio con obturador de plástico
Anuscopes avec obturateur en ébonite
Anoscopi con otturatore di ebanite



ROSCHKE

- ▶ 90-0099
- ø 15-30 mm x 70 mm

Analspreizer
Rectal retractor
Separador para el recto
Dilatateur pour anus
Dilatatore per l'ano



Analspreizer
 Rectal Retractors
 Separadores para el recto
 Dilatateurs pour anus et rectum
 Dilatatori per l'ano ed il retto

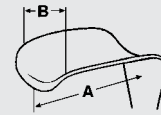

70 x 22 mm
(AxB)



BARR
 90-0100
 18,5 cm, 7 1/4"

55 x 23 mm
(AxB)

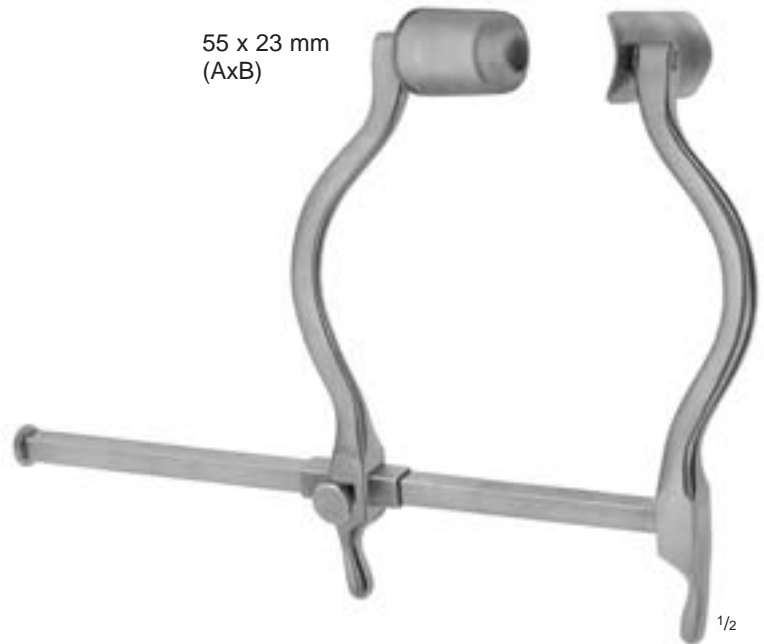

SMITH-BUIE
 90-0110

90-0117



90-0119

ALAN-PARK
 90-0115
 14,5 cm, 5 3/4"

Analspreizer mit Kugelschnellverschluss, komplett, bestehend aus:

- 90-0116 1 Sperrer
- 90-0117 1 Paar Seitenvalven 75 x 22 mm (AxB)
- 90-0118 1 Paar Seitenvalven 95 x 22 mm (AxB)
- 90-0119 1 Mittelvalve 95 x 22 mm (AxB)

Rectal retractor with ball snap closure, complete, consisting of:

- 90-0116 1 Spreader
- 90-0117 1 Pair lateral valves 75 x 22 mm (AxB)
- 90-0118 1 Pair lateral valves 95 x 22 mm (AxB)
- 90-0119 1 Central valve 95 x 22 mm (AxB)

Separador para el recto con cierre esférico, completo, compuesto de:

- 90-0116 1 Separador
- 90-0117 1 Par de valvas laterales 75 x 22 mm (AxB)
- 90-0118 1 Par de valvas laterales 95 x 22 mm (AxB)
- 90-0119 1 Valva central 95 x 22 mm (AxB)

Ecarteur rectal, complet, composé de:

- 90-0116 1 Dilatateur
- 90-0117 1 Paire de valves latérales 75 x 22 mm (AxB)
- 90-0118 1 Paire de valves latérales 95 x 22 mm (AxB)
- 90-0119 1 Valve centrale 95 x 22 mm (AxB)

Dilatatore rettale con chiusura a scatto, completo, composto da:

- 90-0116 1 Dilatatore
- 90-0117 1 Paia di valve laterali 75 x 22 mm (AxB)
- 90-0118 1 Paia di valve laterali 95 x 22 mm (AxB)
- 90-0119 1 Valve centrale 95 x 22 mm (AxB)

Watteträger
Cotton Carrier
Porta-algodón
Porte-cotons
Portacotone

Analsonden
Rectal Probes
Sondas para el recto
Sondes rectales
Sonde rettali

Druckklemme
Pressure Clamp
Pinza-clamp de presión progresiva
Pince-clamp à pression
Pinza/clamp a pressione

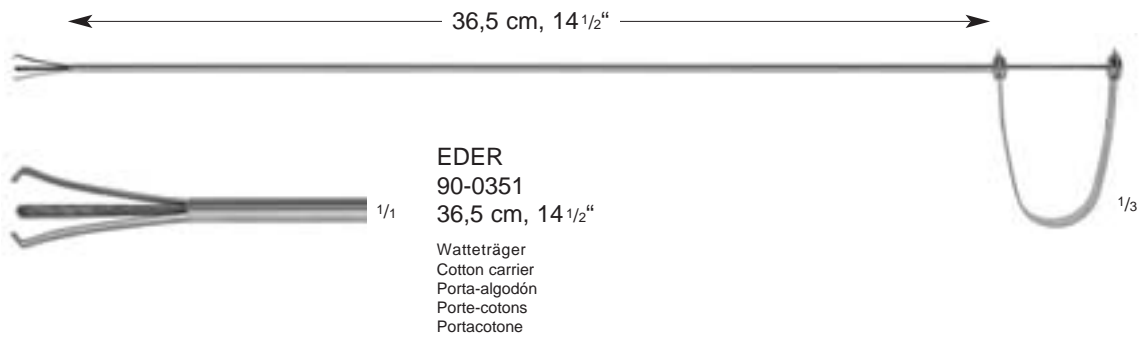

EDER
90-0351
36,5 cm, 14 1/2"

Watteträger
Cotton carrier
Porta-algodón
Porte-cotons
Portacotone

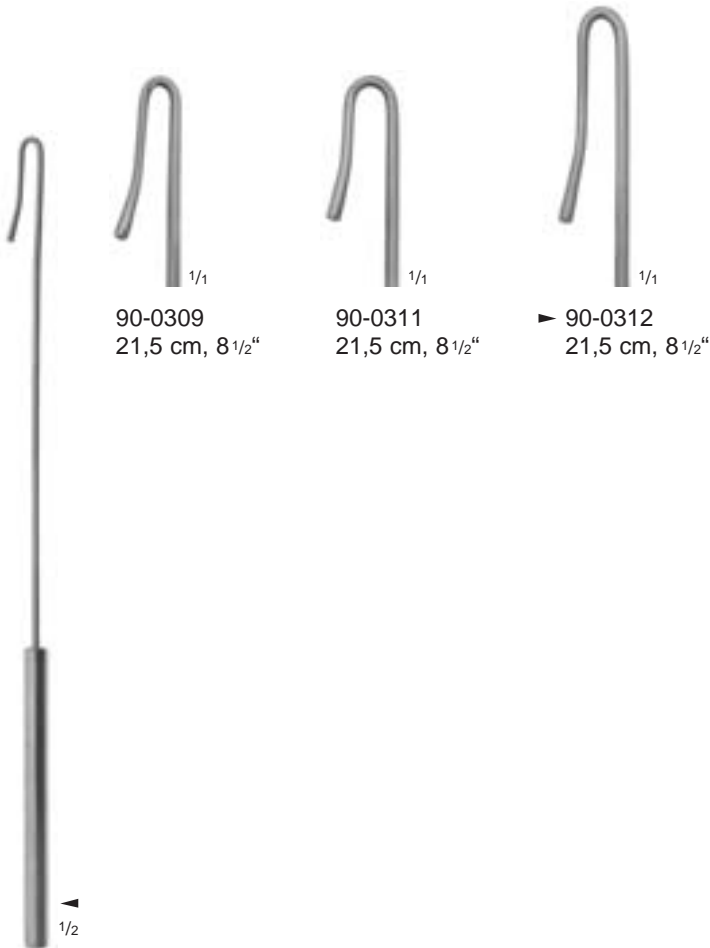

90-0309
21,5 cm, 8 1/2"

90-0311
21,5 cm, 8 1/2"

▶ 90-0312
21,5 cm, 8 1/2"

PRATT
90-0309
- 90-0312

Fistelnsonden (Krypthaken)
Fistula probes (crypt hooks)
Sondas para fistula (gancho para cripta)
Sondes pour fistules (crochets à crypte)
Sonde per fistola (gancio a cripta)

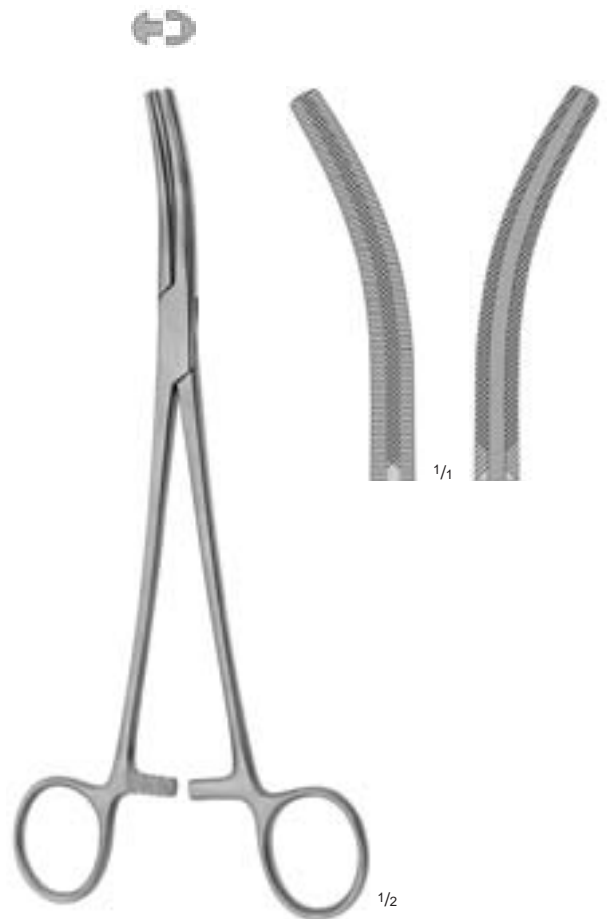

BUIE
90-0955
22 cm, 8 3/4"

Druckklemme
Pressure clamp
Pinza-clamp de presión progresiva
Pince-clamp à pression
Pinza/clamp a pressione



Hämorrhoiden-Faßzange
 Haemorrhoidal Forceps
 Pinza-clamp para hemorroides
 Pincés-clamps pour hémorroïdes
 Pinze per emorroidi

Hämorrhoiden-Ligatoren
 Haemorrhoidal-Ligators
 Ligadores para hemorroides
 Ligateurs hémorroïdaux
 Legatori emorroidali

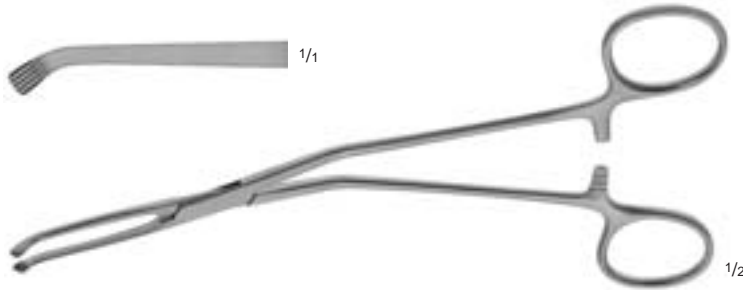

MC GIVNEY
 90-0962
 19 cm, 7 1/2"

Hämorrhoiden-Faßzange
 Haemorrhoidal forceps
 Pinza-clamp para hemorroides
 Pincés-clamps pour hémorroïdes
 Pinze per emorroidi



90-0969

Ligatur-Gummiringe, in Packung à 100 Stück
 Ligature rubber rings, in package of 100 pieces
 Anillos de goma para ligadura, en paquete de 100 piezas
 Bagues de caoutchouc pour ligatures, paquet de 100 pièces
 Anelli di gomma per legatori, conf. 100 pezzi



RUDD
 90-0970
 27,5 cm, 10 3/4"

Hämorrhoiden-Ligator mit Ladekonus ø 12 mm (90-0971)
 Haemorrhoidal ligator with loading attachment ø 12 mm (90-0971)
 Ligador para hemorroides con cono de carga ø 12 mm (90-0971)
 Ligateur hémorroïdales avec cône de charge ø 12 mm (90-0971)
 Legatori emorroidali con carica a cono ø 12 mm (90-0971)

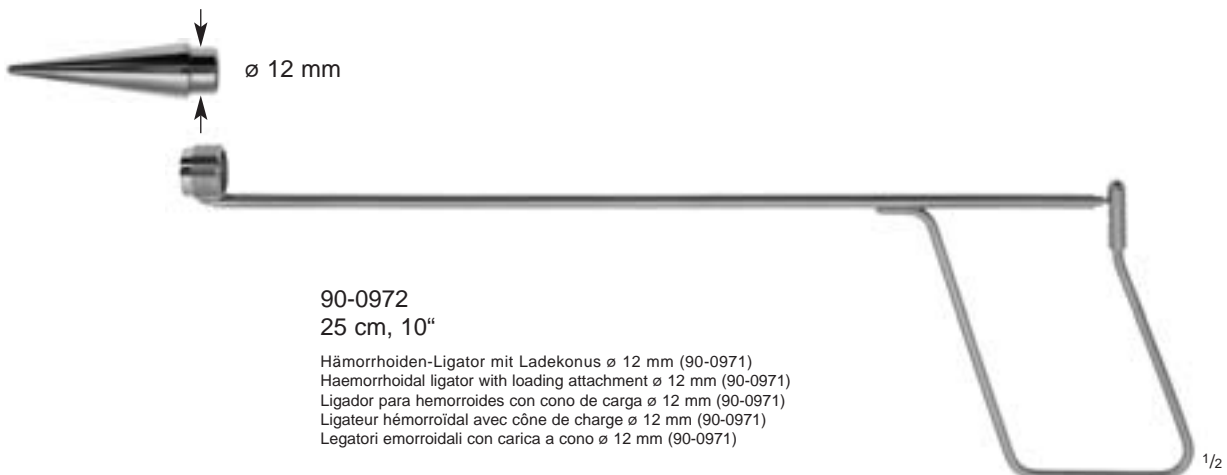

90-0972
 25 cm, 10"

Hämorrhoiden-Ligator mit Ladekonus ø 12 mm (90-0971)
 Haemorrhoidal ligator with loading attachment ø 12 mm (90-0971)
 Ligador para hemorroides con cono de carga ø 12 mm (90-0971)
 Ligateur hémorroïdal avec cône de charge ø 12 mm (90-0971)
 Legatori emorroidali con carica a cono ø 12 mm (90-0971)

Hämorrhoiden-Saugligatoren
 Haemorrhoidal Suction Ligators
 Ligadores de aspiración para hemorroides
 Ligateurs aspirateurs pour hémorroïdes
 Legatori emorroidali con aspiratore



90-0974
 33,5 cm, 13 1/4"

Hämorrhoiden-Saugligator mit Unterbrecher und Ladekegel ø 10 mm (90-0975)
 Haemorrhoidal suction ligator with finger cut-off and loading cone ø 10 mm (90-0975)
 Ligador de aspiración para hemorroides con interruptor y cono de carga ø 10 mm (90-0975)
 Ligateur aspirateur pour hémorroïdes avec interrupteur et cône d'aspiration ø 10 mm (90-0975)
 Legatore emorroidale con aspiratore, leva d'arresto e cono di carica ø 10 mm (90-0975)



90-0976
 36,5 cm, 14 1/2"

Hämorrhoiden-Saugligator mit Unterbrecher und Ladekegel ø 8 mm (90-0977)
 Haemorrhoidal suction ligator with finger cut-off and loading cone ø 8 mm (90-0977)
 Ligador de aspiración para hemorroides con interruptor y cono de carga ø 8 mm (90-0977)
 Ligateur aspirateur pour hémorroïdes avec interrupteur et cône d'aspiration ø 8 mm (90-0977)
 Legatore emorroidale con aspiratore, leva d'arresto e cono di carica ø 8 mm (90-0977)



90-0978
 36,5 cm, 14 1/2"

Hämorrhoiden-Saugligator mit Unterbrecher und Ladekegel ø 10 mm (90-0979)
 Haemorrhoidal suction ligator with finger cut-off and loading cone ø 10 mm (90-0979)
 Ligador de aspiración para hemorroides con interruptor y cono de carga ø 10 mm (90-0979)
 Ligateur aspirateur pour hémorroïdes avec interrupteur et cône d'aspiration ø 10 mm (90-0979)
 Legatore emorroidale con aspiratore, leva d'arresto e cono di carica ø 10 mm (90-0979)



Mastdarm-Biopsiezangen
 Rectal Biopsy Specimen Forceps
 Pinzas sacabocado para biopsia rectal
 Pincers à biopsie rectale
 Pinze taglienti per biopsia rettale

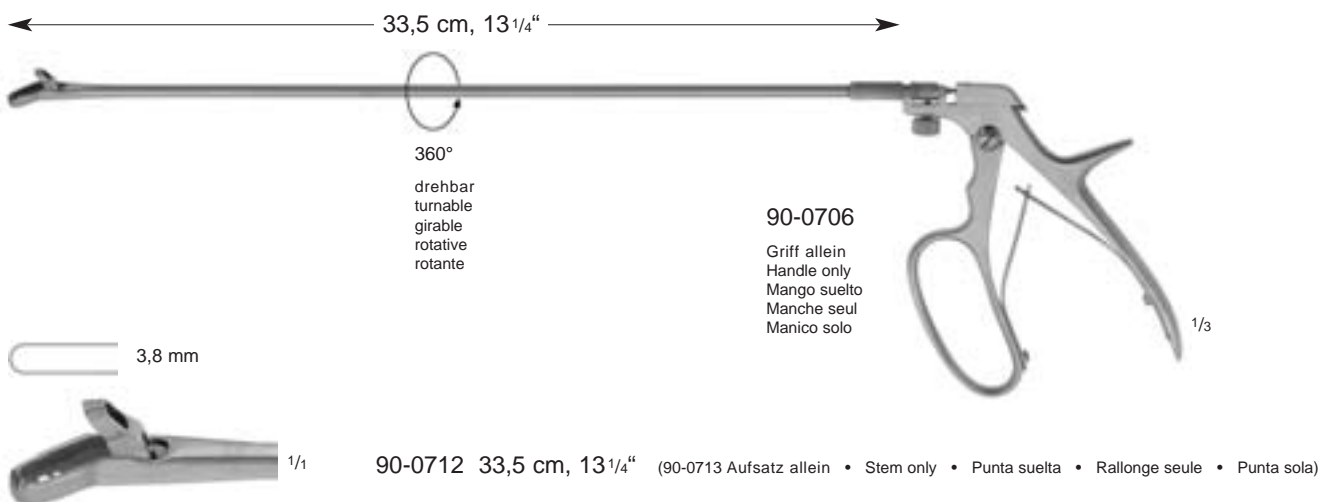
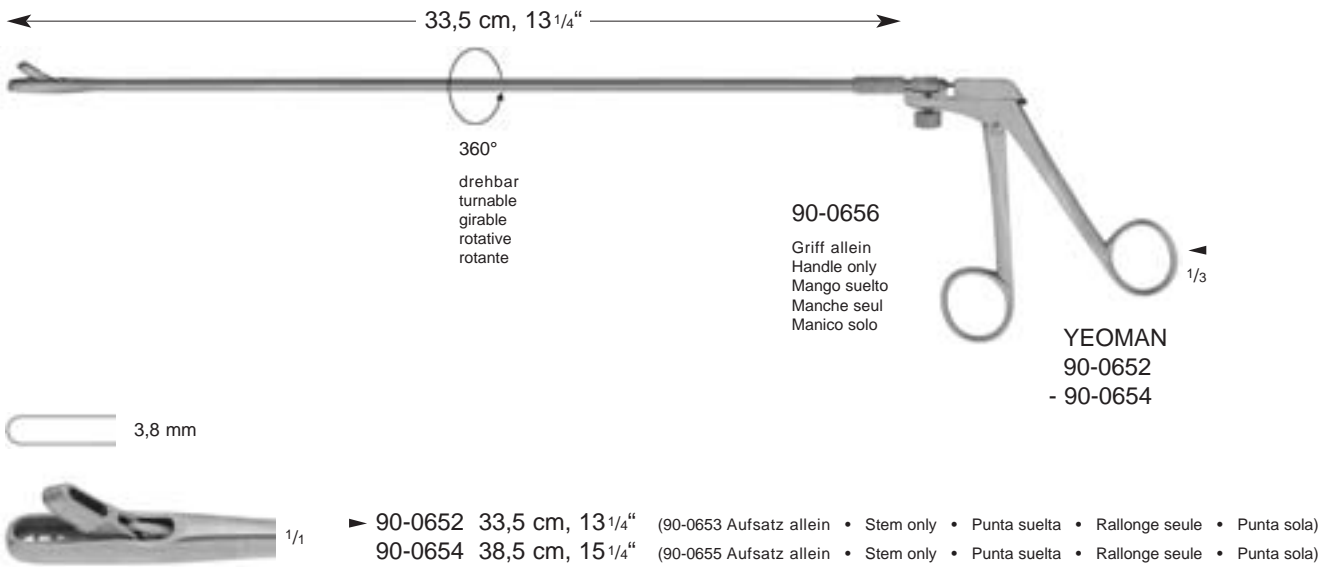
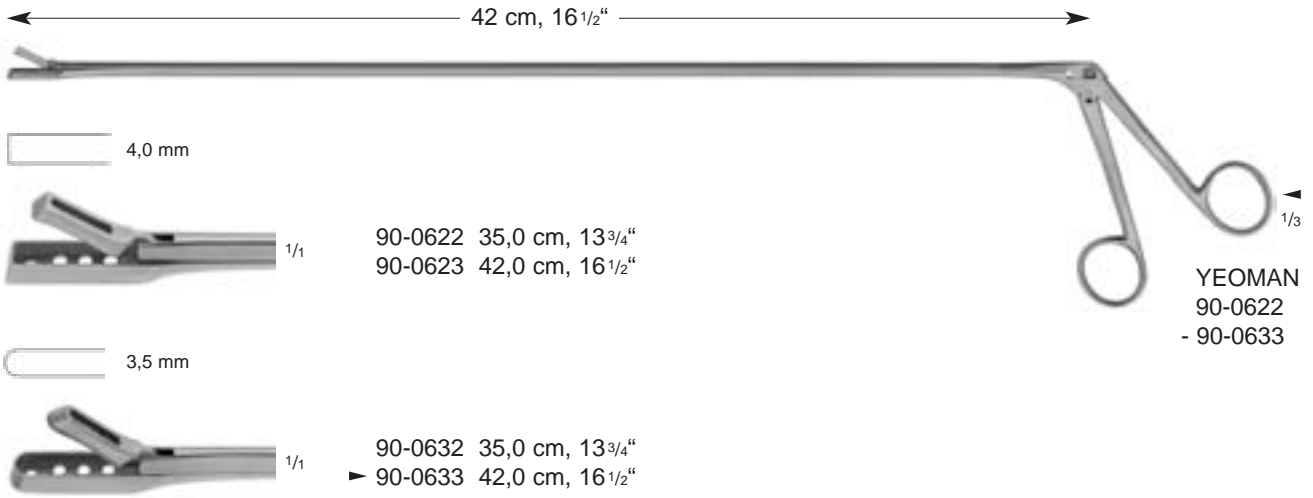



LAWNTON

Medizintechnik



Galle, Leber, Niere, Blase, Urologie
Gall, Liver, Kidney, Bladder, Urology
Bilis, Hígado, Riñón, Vejiga, Urología
Bile, Foie, Rein, Vessie, Urologie
Bile, Fegato, Rene, Vescica, Urologia



Instrumente für Galle, Leber, Niere, Blase und Urologie
Instruments for Gall, Liver, Kidney, Bladder and Urology
Instrumentos para bilis, hígado, riñón, vejiga y urología
Instruments pour bile, foie, rein, vessie et urologie
Strumenti per bile, fegato, rene, vescica e urologia



| | | |
|---|--------|-------------------|
| Gallenblasenzangen | Seite | 23, 209, 389, 457 |
| Gall Bladder Forceps | Page | 23, 209, 389, 457 |
| Pinzas-clamps para la vesícula biliar | Página | 23, 209, 389, 457 |
| Pinces clamps pour vésicule biliaire | Page | 23, 209, 389, 457 |
| Pinze per colecisti | Pagina | 23, 209, 389, 457 |



| | | |
|---|--------|----------|
| Gallenkanal-Klemmzangen | Seite | 178, 189 |
| Gall Duct Forceps | Page | 178, 189 |
| Pinzas-clamps para el conducto biliar | Página | 178, 189 |
| Pince-clamp pour canal biliaire | Page | 178, 189 |
| Pinze per il condotto biliare | Pagina | 178, 189 |



| | | |
|---|--------|-----|
| Gallenkanal- und Cystikus-Klemme | Seite | 182 |
| Gall Duct and Cystic Forceps | Page | 182 |
| Pinzas-clamps para el conducto biliar y cístico | Página | 182 |
| Pinces pour le canal biliaire et cystique | Page | 182 |
| Pinze per il condotto biliare e cistico | Pagina | 182 |



| | | |
|--------------------------------|--------|-----|
| Nierenklemmen | Seite | 190 |
| Kidney Clamps | Page | 190 |
| Pinzas-clamps para renal | Página | 190 |
| Clamps rénaux | Page | 190 |
| Pinze per il rene | Pagina | 190 |



| | | |
|---|--------|----------|
| Nierenstielklemmen | Seite | 191, 195 |
| Kidney Pedicle Clamps | Page | 191, 195 |
| Pinzas clamps para el pedúnculo renal | Página | 191, 195 |
| Pinces-clamps pour pédicules rénaux | Page | 191, 195 |
| Pinze per peduncoli renali | Pagina | 191, 195 |



| | | |
|---|--------|----------|
| Blasenspatel, Blasenwundspreizer | Seite | 268, 310 |
| Bladder Spatulas, Bladder Retractors | Page | 268, 310 |
| Espátulas para la vesícula, Separadores vesicales | Página | 268, 310 |
| Spatules vésicales, Ecarteurs vésicaux | Page | 268, 310 |
| Spatole vescicali, Divaricatori vescicali | Pagina | 268, 310 |



| | | |
|---------------------------------|--------|-----|
| Bumerang-Nadelhalter | Seite | 372 |
| Boomerang Needle Holders | Page | 372 |
| Porta-agujas de bumerang | Página | 372 |
| Porte-aiguilles boomerang | Page | 372 |
| Portaghi boomerang | Pagina | 372 |



ø 5,0 mm



1/2

MOYNIHAN
 11-0265
 34 cm, 13 1/2"

Gallensteinsonde und
 -löffel aus Zinn, biegsam

Gall stone probe and
 scoop of tin, malleable

Sonda y cucharilla para
 los cálculos biliares, maleable

Sonde-curette pour vésicule
 biliaire, malléable

Sonda con cucchiaino per
 calcoli biliari, malleabile



1/1

11-0110
 ø 4,2 mm



1/1

▶ 11-0115
 ø 6,0 mm



1/1

11-0120
 ø 7,0 mm



1/2

DESJARDINS
 11-0110
 -11-0120
 28 cm, 11"

Gallengangsonden,
 federnd

Gall duct probes,
 flexible

Sondas para el conducto
 biliar, flexible

Dilatateurs à voies biliaires
 flexible

Dilatatori per condotti biliari
 flessibili

ø 3,5 mm

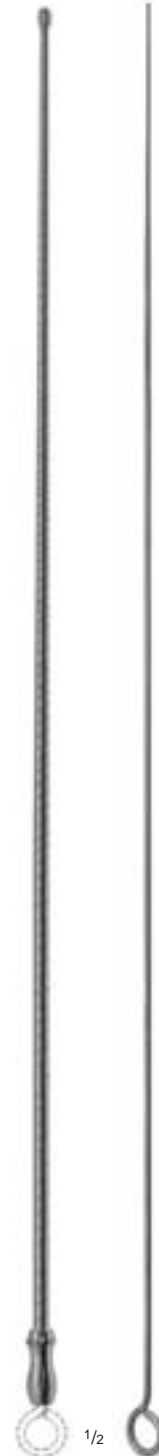

1/2

OCHSNER
 11-0100
 38,5 cm, 15 1/4"

Gallengangsonde,
 federnd

Gall duct probes,
 flexible

Sonda para el conducto
 biliar, flexible

Dilatateur à voies biliaires
 flexible avec conducteur

Dilatatore per condotti biliari
 flessibile



Gallengang-Dilatationsoliven
 Common Bile Duct Dilators
 Dilatadores para el conducto biliar
 Dilatateurs biliaires
 Dilatatore per coledoco

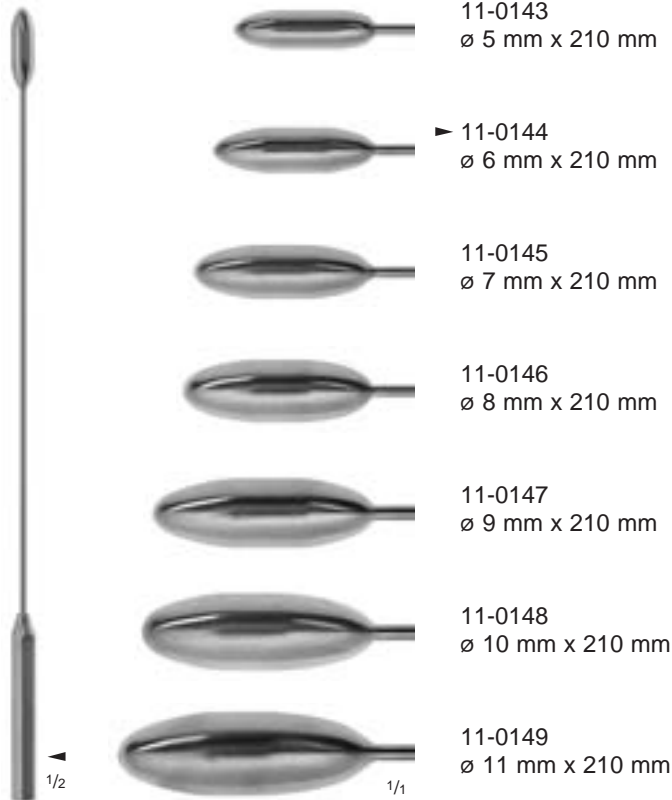

- 11-0141
ø 3 mm x 210 mm
- 11-0142
ø 4 mm x 210 mm
- 11-0143
ø 5 mm x 210 mm
- ▶ 11-0144
ø 6 mm x 210 mm
- 11-0145
ø 7 mm x 210 mm
- 11-0146
ø 8 mm x 210 mm
- 11-0147
ø 9 mm x 210 mm
- 11-0148
ø 10 mm x 210 mm
- 11-0149
ø 11 mm x 210 mm

BAKES
11-0140

Satz von 9 Gallengang-Dilatationsoliven 11-0141 bis 11-0149, biegsam, in Plastiktasche (11-0139)

Set of 9 common bile duct dilators 11-0141 to 11-0149, malleable, in plastic roll (11-0139)

Juego de 9 dilatadores para el conducto biliar del 11-0141 al 11-0149, maleable, en bolsa de plástico (11-0139)

Jeu de 9 dilatateurs biliaires du 11-0141 au 11-0149 malléables en sachet plastique (11-0139)

Set di 9 dilatatori per condotti biliari dal 11-0141 al 11-0149, malleabili, con rotolo di plastica (11-0139)

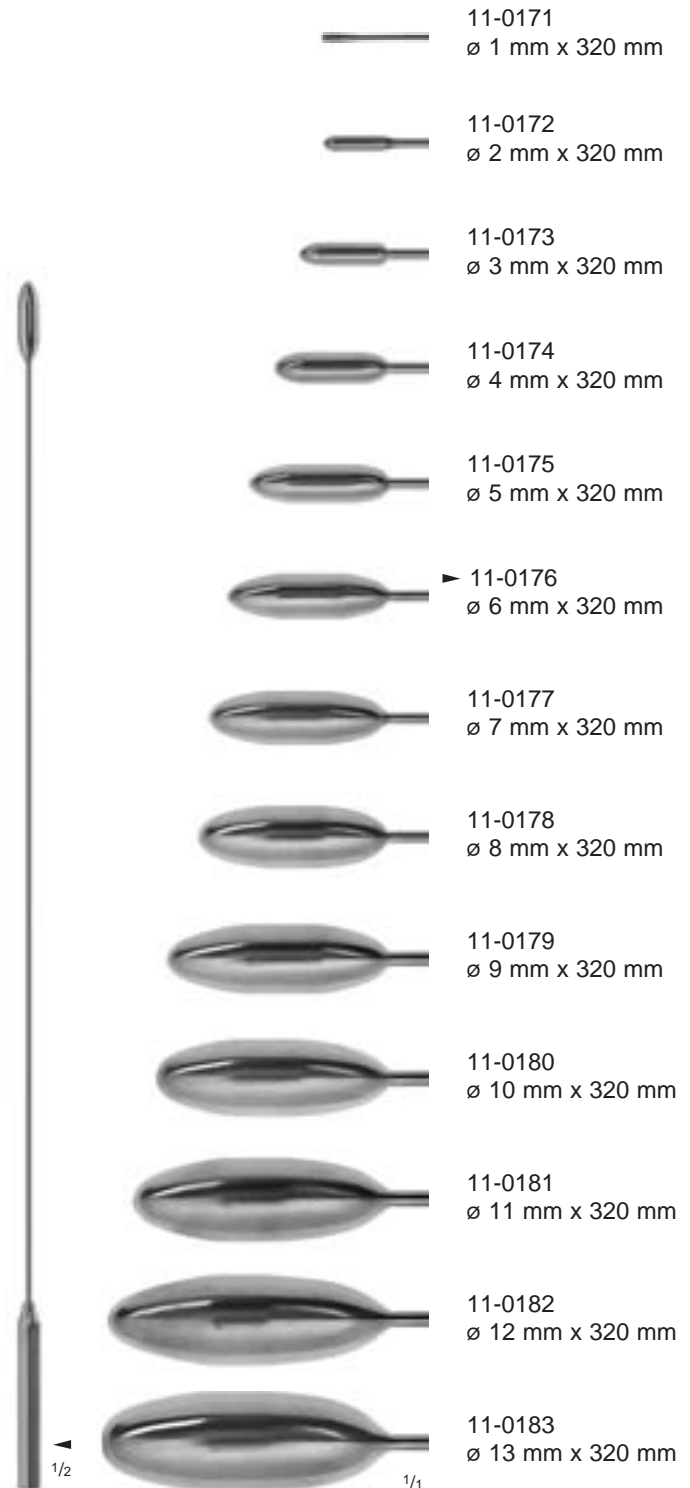

- 11-0171
ø 1 mm x 320 mm
- 11-0172
ø 2 mm x 320 mm
- 11-0173
ø 3 mm x 320 mm
- 11-0174
ø 4 mm x 320 mm
- 11-0175
ø 5 mm x 320 mm
- ▶ 11-0176
ø 6 mm x 320 mm
- 11-0177
ø 7 mm x 320 mm
- 11-0178
ø 8 mm x 320 mm
- 11-0179
ø 9 mm x 320 mm
- 11-0180
ø 10 mm x 320 mm
- 11-0181
ø 11 mm x 320 mm
- 11-0182
ø 12 mm x 320 mm
- 11-0183
ø 13 mm x 320 mm

BAKES
11-0170

Satz von 13 Gallengang-Dilatationsoliven 11-0171 bis 11-0183, biegsam, in Plastiktasche (11-0186)

Set of 13 common bile duct dilators 11-0171 to 11-0183, malleable, in plastic roll (11-0186)

Juego de 13 dilatadores para el conducto biliar del 11-0171 al 11-0183, maleable, en bolsa de plástico (11-0186)

Jeu de 13 dilatateurs biliaires du 11-0171 au 11-0183 malléables en sachet plastique (11-0186)

Set di 13 dilatatori per condotti biliari dal 11-0171 al 11-0183, malleabili, con rotolo di plastica (11-0186)

Gallensteinlöffel
 Gall Stone Scoops
 Cucharillas para los cálculos biliares
 Curettes pour calculs biliaires
 Cucchiari per calcoli biliari

Gallenblasenlöffel
 Gall bladder scoop
 Cucharilla para la vesicula biliar
 Cuiller pour vésicule biliaire
 Cucchiario per colecisti



MAYO
 11-0200
 27,5 cm, 10^{3/4}“

Gallensteinlöffel
 Gall Stone Scoops
 Cucharillas para los cálculos biliares
 Curettes pour calculs biliaires
 Cucchiari per calcoli biliari

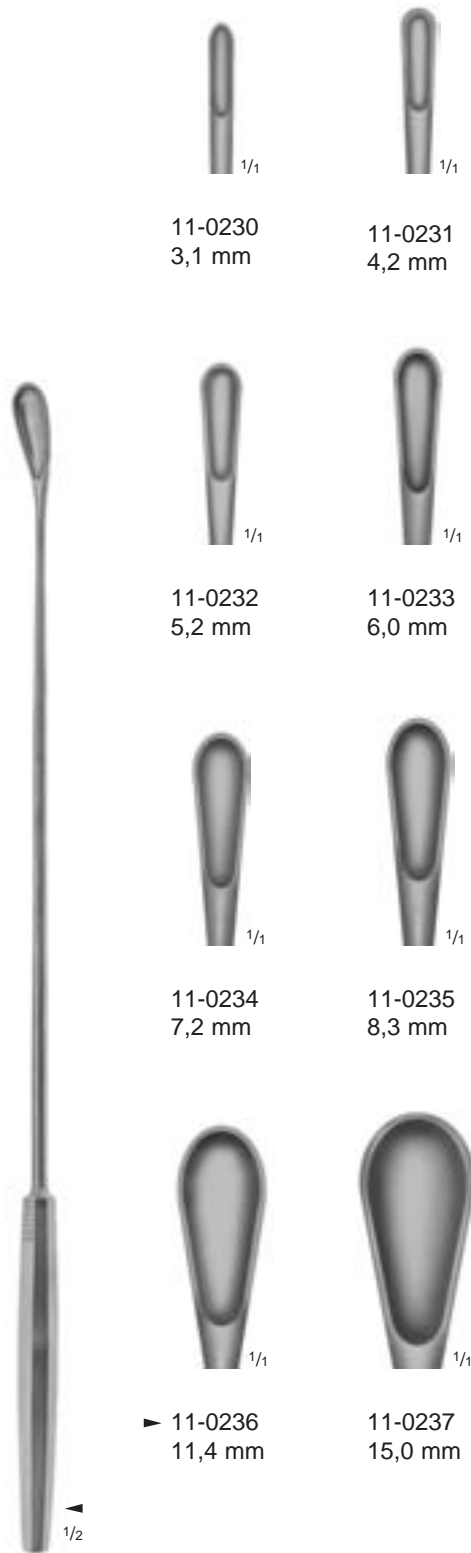

LUER-KOERTE
 11-0230
 - 11-0237
 31 cm, 12^{1/4}“

Gallensteinlöffel, biegsam
 Gall Stone Scoops, malleable
 Cucharillas para los cálculos biliares, maleable
 Curettes pour calculs biliaires, malléables
 Cucchiari per calcoli biliari, malleabili



MOORE
 11-0240
 30 cm, 12“

Gallenblasenlöffel
 Gall bladder scoop
 Cucharilla para la vesicula biliar
 Cuillère pour vésicule biliaire
 Cucchiario per colecisti



Gallensteinzangen
Gall Stone Forceps
Pinzas para los cálculos biliares
Pinces pour calculs biliaires
Pince per calcoli biliari



1/1

► 11-0309
21 cm, 8 1/4"



1/1

11-0310
21 cm, 8 1/4"

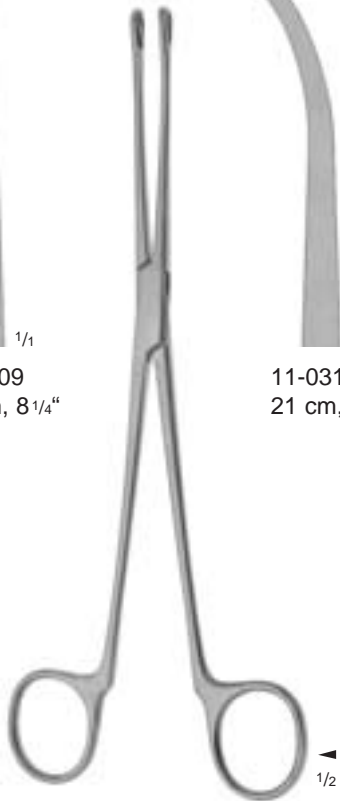

1/2

BLAKE
11-0309
- 11-0310



1/1

► 11-0314
20,5 cm, 8"



1/1

11-0315
20,5 cm, 8"

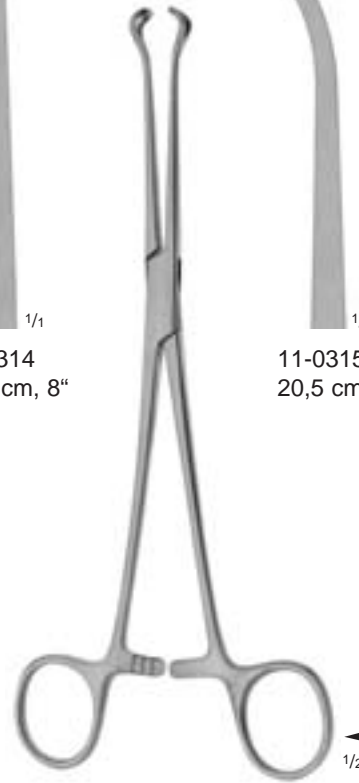

1/2

MAYO-BLAKE
11-0314
- 11-0315



MIXTER
 11-0305
 22,5 cm, 9"



11-0300
 23 cm, 9"

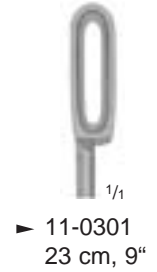

▶ 11-0301
 23 cm, 9"



DESJARDINS
 11-0300
 - 11-0301



Nierensteinzangen
Kidney Stone Forceps
Pinzas para los cálculos renales
Pincers pour les calculs rénaux
Pinze per calcoli renali



▶ 92-0504
23 cm, 9"

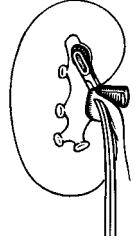

92-0503
20,5 cm, 8"

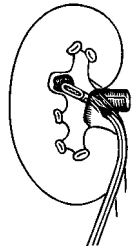

92-0502
19 cm, 7 1/2"

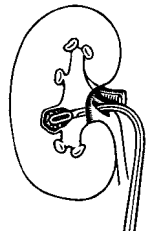

RANDALL
92-0501
- 92-0504



92-0501
18 cm, 7"

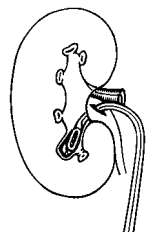

Nierensteinzangen
Kidney Stone Forceps
Pinzas para los cálculos renales
Pincés pour les calculs rénaux
Pinze per calcoli renali

Nierenfaßzange
Kidney Elevating Forceps
Pinza para sostener el riñón
Pince pour la préhension du rein
Pinza per afferrare il rene



▶ 92-0505
19 cm, 7 1/2"

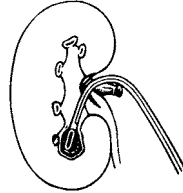

92-0506
19 cm, 7 1/2"

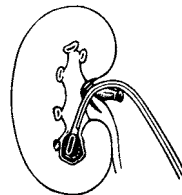

RANDALL
92-0505
- 92-0506

Nierensteinzangen
Kidney Stone Forceps
Pinzas para los cálculos renales
Pincés pour les calculs rénaux
Pinze per calcoli renali



DARTIGUES
96-0815
28 cm, 11"

Nierenfaßzange
Kidney elevating forceps
Pinza para sostener el riñón
Hystérolabe
Pinza per afferrare il rene



Prostatahaken
 Prostatic Retractors
 Separadores para la prostata
 Ecarteurs prostatiques
 Retrattori prostatici

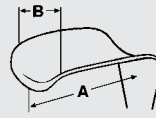

23 x 25 mm (AxB)



68 x 38 mm (AxB)



36 x 13 mm (AxB)



36 x 38 mm (AxB)



YOUNG
 92-0200
 23 cm, 9"

Bulbus-Haken
 Bulbus hook
 Gancho para el bulbus
 Crochet en bulbus
 Bulbo ad uncino



YOUNG
 92-0205
 22 cm, 8³/₄"

anterior
 anterior
 anterior
 antérieur
 anteriore



YOUNG
 92-0210
 22,5 cm, 9"

lateral
 lateral
 lateral
 latéral
 laterale



YOUNG
 92-0215
 21,5 cm, 8¹/₂"

gegabelt
 forked
 horquilla
 en fourche
 a forchetta



MILLIN
 92-0256
 29,5 cm, 11 3/4"
 Blasenhalsspreizer
 Bladder neck spreader
 Dilatador para el cuello vesical
 Dilatateur vésicale
 Dilatatore per collo vescicale

1/2



MILLIN
 92-0251
 23 cm, 9"

KapselFaßzange, zur retropubi-
 schen Prostatektomie

Capsule forceps, for retropubic
 prostatectomy

Pinza capsular para prostatectomía
 retropúbica

Pince pour saisir les capsules, pour
 prostatectomie rétropubienne

Pinza per prendere capsule, per
 prostatectomia retropubica

1/2



MILLIN
 92-0252
 23 cm, 9"

Faßzange, 8x7 Zähne, für die vor-
 deren Lappen

Prostatic lobe holding forceps, for
 anterior lobes, 8x7 teeth

Pinza para coger los lóbulos anterior-
 res, 8x7 dientes

Pince pour saisir les lambeaux
 antérieurs, 8x7 dents

Pinza per afferrare i lobi prostatici
 anteriori, 8x7 denti

1/2



MILLIN
 92-0255
 24 cm, 9 1/2"

Fadenführungs-
 zange

Ligature carrying forceps

Pinza porta-ligaduras supra-pubiana

Pince porte-fil

Pinza portafilo

1/2



Dilatationsbougies
 Dilating Bougies
 Bujías dilatadoras
 Bougies dilatatrices
 Candelette dilatatrici

Metallkatheter
 Metal Catheters
 Sondas metálicas
 Sondes vésicales métalliques
 Cateteri metallici



| VAN BUREN | Ø mm | Charr. (French) |
|-----------|--------------------------------|--------------------|
| 92-1408 | 2 ² / ₃ | 8 |
| 92-1410 | 3 ¹ / ₃ | 10 |
| 92-1412 | 4 | 12 |
| 92-1414 | 4 ² / ₃ | 14 |
| ▶ 92-1416 | 5 ¹ / ₃ | 16 |
| 92-1418 | 6 | 18 |
| 92-1420 | 6 ² / ₃ | 20 |
| 92-1422 | 7 ¹ / ₃ | 22 |
| 92-1424 | 8 | 24 |
| 92-1426 | 8 ² / ₃ | 26 |
| 92-1428 | 9 ¹ / ₃ | 28 |
| 92-1430 | 10 | 30 |
| 92-1432 | 10 ² / ₃ | 32 |
| 92-1434 | 11 ¹ / ₃ | 34 |
| 92-1436 | 12 | 36 |

27,5 cm, 10³/₄"

Dilatationsbougies
 Dilating bougies
 Bujías dilatadoras
 Bougies dilatatrices
 Candelette dilatatrici

| | Ø mm | Charr. (French) |
|-----------|-------------------------------|--------------------|
| ▶ 92-1752 | 2 ² / ₃ | 8 |
| 92-1754 | 3 ¹ / ₃ | 10 |
| 92-1756 | 4 | 12 |
| 92-1758 | 4 ² / ₃ | 14 |
| 92-1760 | 5 ¹ / ₃ | 16 |
| 92-1762 | 6 | 18 |
| 92-1764 | 6 ² / ₃ | 20 |

15 cm, 6"

Metallkatheter für Frauen
 Metal catheters for women
 Sondas metálicas para mujeres
 Sondes vésicales métalliques pour femmes
 Cateteri metallici per donne

| | Ø mm | Charr. (French) |
|-----------|-------------------------------|--------------------|
| ▶ 92-1730 | 2 ² / ₃ | 8 |
| 92-1732 | 3 ¹ / ₃ | 10 |
| 92-1734 | 4 | 12 |
| 92-1736 | 4 ² / ₃ | 14 |
| 92-1738 | 5 ¹ / ₃ | 16 |
| 92-1740 | 6 | 18 |
| 92-1742 | 6 ² / ₃ | 20 |

25 cm, 10"

Metallkatheter für Männer
 Metal catheters for men
 Sondas metálicas para hombres
 Sondes vésicales métalliques pour hommes
 Cateteri metallici per uomini



1/3

GUYON
 92-0480
 39 cm, 15 1/2"

Katheter-
Einführungsinstrument
 Catheter introducing
instrument
 Instrumento para
introducir catéteres
 Mandrin pour sondes en
gomme
 Strumento per introdurre
cateteri o sonde



1/3

GUYON
 92-0481
 35 cm, 13 3/4"

Katheterspanner und
Einführungsinstrument
 Catheter guide (introducer)
 Guía para catéteres
(introductor)
 Mandrin pour sondes
 Catetere guida (interduttore)



1/3

DITTEL
 92-0486
 46 cm, 18"

Katheterspanner und
Einführungsinstrument
 Catheter guide (introducer)
 Guía para catéteres
(introductor)
 Mandrin pour sondes
 Catetere guida (interduttore)



1/1



1/2

92-0544
 14,5 cm, 5 3/4"

Klemme zum Fixieren des
Samenstrangs
 Fixation clamp for the sperma-
tic cord
 Pinza para fijar el cordón
espermático
 Pince pour fixer le cordon
spermatique
 Pinza per fissare il tronco
spermatico



1/1

1/1

1/2

92-0546
 27 cm, 10 3/4"

Sekretlöffel, biegsam
 Secretion curette,
malleable
 Cucharilla para secreción,
maleable
 Cuillères pour prélèvements
des sécrétions, malléables
 Curetta per secrezioni,
malleabile



Urologie-Instrumente
Genito-Urinary Instruments
Instrumentos para la urología
Instruments pour l'urologie
Strumenti per l'urologia

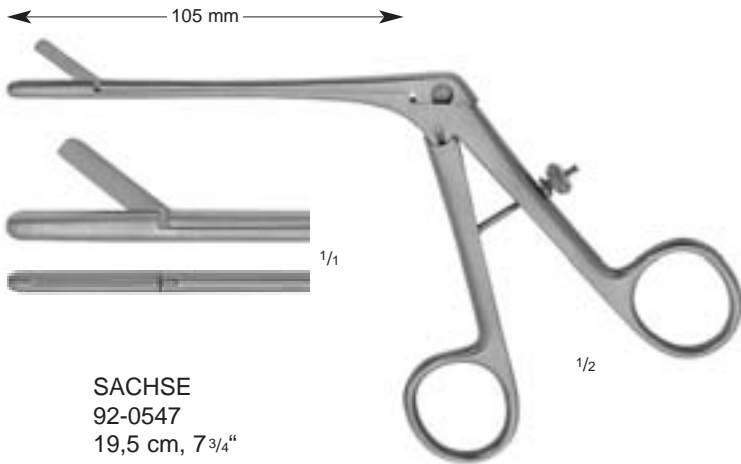

SACHSE
92-0547
19,5 cm, 7³/₄"

Meatotom
Meatotome
Meatótomo
Méatotome
Meatotomo



92-0549

KNUTSON
92-0548

Urethrographie-Instrument, bestehend aus verstellbarer Penishalterung mit verschiebbarer Kanüle mit Konus (92-0549)

Urethrography-instrument consisting of holder, penile, adjustable with sliding cannula with cone (92-0549)

Instrumento de uretrografía, compuesto del soporte para el pene ajustable, con cánula regulable con cono (92-0549)

Uréthrographe avec support réglable pour le pénis, canule à robinet, avec embout (92-0549)

Strumento per ureterografia, composto da supporto per il pene regolabile, con cannula scorrevole e cono (92-0549)

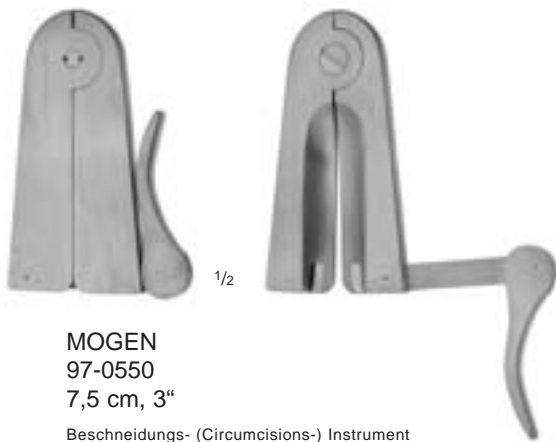

MOGEN
97-0550
7,5 cm, 3"

Beschneidungs- (Circumcisions-) Instrument
Circumcision instrument
Instrumento para circuncisión
Instrument de circoncision
Strumento per circoncisione



97-0552 ø 8 mm

für Säuglinge • baby size • para bebés • pour bébés • per neonati

97-0553 ø 11 mm

97-0554 ø 13 mm

für Knaben • child size • para niños • pour garçons • per bambini

► 97-0555 ø 16 mm

97-0556 ø 21 mm

für Jugendliche • adolescent size • para adolescentes • pour adolescents • per adolescenti

97-0557 ø 26 mm

97-0558 ø 32 mm

für Männer • men's size • para hombres • pour hommes • per uomini

Beschneidungs- (Circumcisions-) Instrumente
Circumcision instruments
Instrumentos para circuncisión
Instruments de circoncision
Strumenti per circoncisione



STOCKMANN
92-0370
8 cm, 3¹/₈"

Penisklemme
Penis clamp
Compresseur urétral
Compresseur de l'urètre
Serrapene



STRAUSS
92-0372
11 cm, 4³/₈"

Penisklemme
Penis clamp
Compresseur urétral
Compresseur de l'urètre
Serrapene

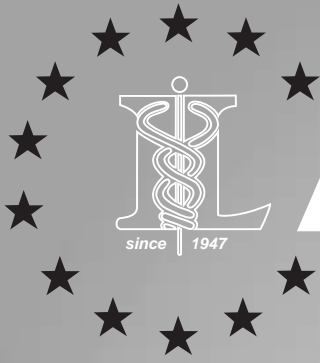

LAWNTON

Medizintechnik



Gynäkologie
Gynecology
Ginecología
Gynécologie
Ginecologia



Instrumente für Gynäkologie
 Instruments for Gynecology
 Instrumentos para ginecología
 Instruments pour gynécologie
 Strumenti per ginecologia



| | | |
|--|--------|---------|
| Polypen- und Ovarienzangen | Seite | 23, 389 |
| Polypus and Ovum Forceps | Page | 23, 389 |
| Pinzas para pólipos uterinos y ovarios | Página | 23, 389 |
| Pinces à polypes et ovaires | Page | 23, 389 |
| Pinze per polipi e ovaie | Pagina | 23, 389 |



| | | |
|---|--------|----|
| DURACUT® Gynäkologische Scheren mit Hartmetallschneiden | Seite | 60 |
| DURACUT® Gynecological Scissors with tungsten carbide edges | Page | 60 |
| DURACUT® Tijeras para ginecología con filos de carburo tungsteno | Página | 60 |
| DURACUT® Ciseaux pour gynécologie avec des lames en tungstène | Page | 60 |
| DURACUT® Forbici per ginecologia con lame in carburo di tungsteno | Pagina | 60 |



| | | |
|-----------------------------|--------|---------------|
| Uterusscheren | Seite | 86, 104 - 106 |
| Uterine Scissors | Page | 86, 104 - 106 |
| Tijeras para el útero | Página | 86, 104 - 106 |
| Ciseaux utérins | Page | 86, 104 - 106 |
| Forbici per utero | Pagina | 86, 104 - 106 |



| | | |
|--|--------|-----------|
| Hysterektomieklemmen | Seite | 194 - 196 |
| Hysterectomy Forceps | Page | 194 - 196 |
| Pinzas-clamps para hysterectomía | Página | 194 - 196 |
| Pinces à hystérectomie | Page | 194 - 196 |
| Pinze per isterectomia | Pagina | 194 - 196 |



| | | |
|--|--------|-----|
| ATRAUMATIC-GRIP Hysterektomieklemmen | Seite | 197 |
| ATRAUMATIC-GRIP Hysterectomy Forceps | Page | 197 |
| ATRAUMATIC-GRIP Pinzas-clamps para hysterectomía | Página | 197 |
| ATRAUMATIC-GRIP Pinces à hystérectomie | Page | 197 |
| ATRAUMATIC-GRIP Pinze per isterectomia | Pagina | 197 |



| | | |
|--------------------------------|--------|----------|
| Tamponzangen | Seite | 205, 208 |
| Uterine Dressing Forceps | Page | 205, 208 |
| Pinzas para tampones | Página | 205, 208 |
| Pinces à pansements | Page | 205, 208 |
| Pinze per medicature | Pagina | 205, 208 |



| | | |
|---|--------|-----------|
| Tupfer- und Schwammzangen | Seite | 209 - 210 |
| Dressing and Sponge Holding Forceps | Page | 209 - 210 |
| Pinzas para torundas y esponjas | Página | 209 - 210 |
| Pincès à tampons et éponges | Page | 209 - 210 |
| Pinze per tamponi e spugne | Pagina | 209 - 210 |



| | | |
|----------------------------------|--------|-----|
| Fistelhaken | Seite | 221 |
| Fistula Hooks | Page | 221 |
| Ganchos para fístulas | Página | 221 |
| Crochets pour les fistules | Page | 221 |
| Uncini per fistole | Pagina | 221 |



| | | |
|---------------------------|--------|----------|
| Scheidenspekula | Seite | 248, 304 |
| Vaginal Specula | Page | 248, 304 |
| Espéculos vaginales | Página | 248, 304 |
| Spéculums vaginaux | Page | 248, 304 |
| Speculi vaginali | Pagina | 248, 304 |



| | | |
|---------------------------|--------|-----|
| Scheidenhalter | Seite | 254 |
| Vaginal Retractors | Page | 254 |
| Valvas vaginales | Página | 254 |
| Valves vaginales | Page | 254 |
| Retrattori vaginali | Pagina | 254 |



| | | |
|---------------------------------|--------|-----|
| Vulva-Spreizer | Seite | 281 |
| Vaginal Retractors | Page | 281 |
| Separadores para la vulva | Página | 281 |
| Ecarteurs vulvaires | Page | 281 |
| Divaricatori vaginali | Pagina | 281 |



| | | |
|-----------------------------------|--------|-----|
| Uterusfaßzange | Seite | 421 |
| Uterine Elevating Forceps | Page | 421 |
| Pinzas para el útero | Página | 421 |
| Pincès hystérolabes | Page | 421 |
| Pinze per sollevare l'utero | Pagina | 421 |





Scheidenspekula
Vaginal Specula
Espécules vaginales
Spéculums vaginaux
Speculi vaginali

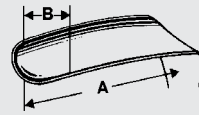

CUSCO
95-0010
75 x 17 mm (AxB)

Scheidenspekulum für Jungfrauen, mit seitlicher Stellschraube, Griff umlegbar

Vaginal speculum for virgins with lateral fixation screw, tilt-down handle

Espéculo vaginal para vírgenes, con tornillo de sujeto lateral, mango plegable

Spéculum vaginal pour vierges, avec fixation latérale à vis

Speculo vaginale per vergini, con vite di regolazione laterale



CUSCO
95-0197 75 x 32 mm (AxB)
▶ 95-0198 85 x 35 mm (AxB)
95-0199 100 x 35 mm (AxB)

Scheidenspekula mit seitlicher Stellschraube, Griff umlegbar

Vaginal specula with lateral fixation screw, tilt-down handle

Espécules vaginales con tornillo de sujeto lateral, mango plegable

Spéculums vaginaux, avec fixation latérale à vis

Speculi vaginali, con vite di regolazione laterale



CUSCO
95-0030
75 x 17 mm (AxB)

Scheidenspekulum für Jungfrauen, mit zentraler Stellschraube, Griff umlegbar

Vaginal speculum for virgins with central fixation screw, tilt-down handle

Espéculo vaginal para vírgenes, con tornillo de sujeto central, mango plegable

Spéculum vaginal pour vierges, avec fixation centrale à vis

Speculo vaginale per vergini, con vite di regolazione centrale



CUSCO
▶ 95-0037 75 x 32 mm (AxB)
95-0038 85 x 35 mm (AxB)
95-0039 100 x 35 mm (AxB)

Scheidenspekula mit zentraler Stellschraube, Griff umlegbar

Vaginal specula with central fixation screw, tilt-down handle

Espécules vaginales con tornillo de sujeto central, mango plegable

Spéculums vaginaux, avec fixation centrale à vis

Speculi vaginali, con vite di regolazione centrale

Scheidenspekula
 Vaginal Specula
 Espécules vaginales
 Spéculums vaginaux
 Speculi vaginali

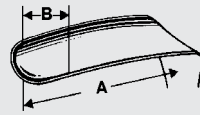

CUSCO

- 95-0015 90 x 22-25 mm (AxB)
- ▶ 95-0016 100 x 25-27 mm (AxB)
- 95-0017 105 x 27-30 mm (AxB)

Scheidenspekula, Schweizer Modell (konisch), mit seitlicher Stellschraube, Griff umlegbar

Vaginal specula, Swiss pattern, cone shaped, with lateral fixation screw, tilt-down handle

Espécules vaginales, modèle suisse (cônic), con tornillo de sujeción lateral, mango plegable

Spéculums vaginaux, modèle suisse (conique), avec fixation latérale à vis

Speculi vaginali, modello svizzero, profilo a cono con vite di regolazione laterale



TRELAT

- 95-0020 85 x 33 mm (AxB)
- ▶ 95-0021 95 x 35 mm (AxB)
- 95-0022 115 x 43 mm (AxB)

Scheidenspekula, parallel öffnend, Griff umlegbar

Vaginal specula, parallel opening, tilt-down handle

Espécules vaginales, apertura paralela, mango plegable

Spéculums vaginaux, à valves parallèles

Speculi vaginali, apertura parallela



COLLIN

- 95-0080 90 x 28 mm (AxB)
- ▶ 95-0081 100 x 35 mm (AxB)
- 95-0082 110 x 40 mm (AxB)

Scheidenspekula
 Vaginal specula
 Espécules vaginales
 Spéculums vaginaux
 Speculi vaginali



COLLIN-LANDAU

- 95-0085 90 x 28 mm (AxB)
- ▶ 95-0086 100 x 35 mm (AxB)
- 95-0087 110 x 40 mm (AxB)

Scheidenspekula, oberes Spekulablatt kürzer
 Vaginal specula, upper blade of specula shortened
 Espécules vaginales, valvas superior más corta
 Spéculums vaginaux, valve supérieure plus courte
 Speculi vaginali, valva superiore corta



Scheidenspekula
Vaginal Specula
Espéculos vaginales
Spéculums vaginaux
Speculi vaginali

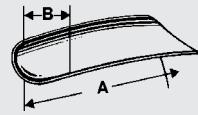

SEMM

- 95-0119 90 x 14-18 mm (AxB)
- ▶ 95-0120 100 x 17-20 mm (AxB)
- 95-0121 100 x 25-30 mm (AxB)

Scheidenspekula mit Doppelsperre,
für Einhandbedienung

Vaginal specula with double lock,
one-hand operated

Espéculos vaginales con cierre doble,
para el uso con una mano

Spéculums vaginaux, double ouverture
utilisé à la main

Speculi vaginali, a doppio fermo,
impiego con una mano

1/2

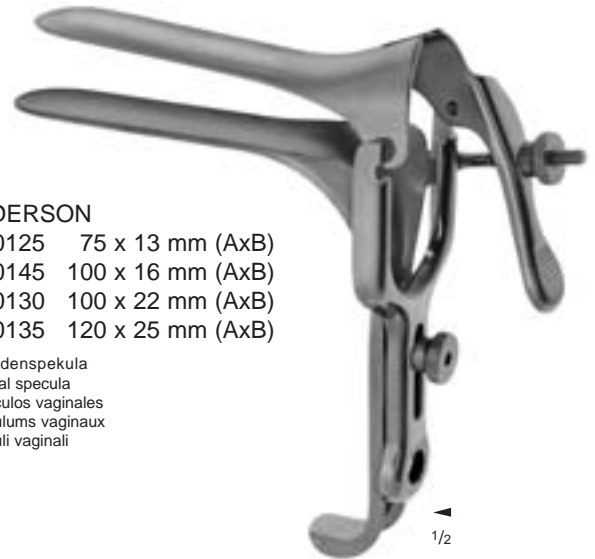

PEDERSON

- 95-0125 75 x 13 mm (AxB)
- 95-0145 100 x 16 mm (AxB)
- ▶ 95-0130 100 x 22 mm (AxB)
- 95-0135 120 x 25 mm (AxB)

Scheidenspekula
Vaginal specula
Espéculos vaginales
Spéculums vaginaux
Speculi vaginali

1/2

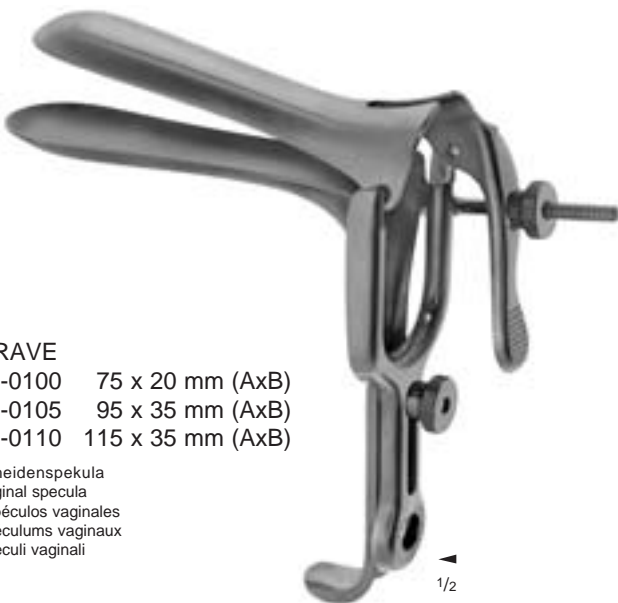

GRAVE

- 95-0100 75 x 20 mm (AxB)
- ▶ 95-0105 95 x 35 mm (AxB)
- 95-0110 115 x 35 mm (AxB)

Scheidenspekula
Vaginal specula
Espéculos vaginales
Spéculums vaginaux
Speculi vaginali

1/2



GRAVE modif.

- 95-0156
100 x 35 mm (AxB)

Scheidenspekulum, rechte Seite offen
Vaginal speculum, right side open
Espéculo vaginal, parte derecha abierta
Spéculum vaginaux, ouverts à droite
Speculo vaginale, apertura a destra

1/2

Scheidenspekula
Vaginal Specula
Espécúlos vaginales
Spécúlums vaginaux
Speculi vaginali

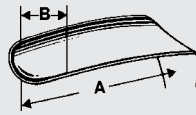

Oberfläche geschwärzt
Surface black-finish
Superficie negra
Surface noire
Superficie nera



PEDERSON

- 95-0040 75 x 13 mm (AxB)
- ▶ 95-0041 100 x 22 mm (AxB)
- 95-0042 120 x 25 mm (AxB)

Scheidenspekula für Laserchirurgie, mit Absaugung am oberen Blatt

Vaginal specula for laser surgery, suctioning from upper blade

Espécúlos vaginales para la cirugía con laser, tubo de succión en la valva superior

Spécúlums vaginaux pour chirurgie laser, avec embout aspiration sur la valve supérieure

Speculi vaginali per chirurgia laser, aspirazione dalla valva superiore

1/2

PEDERSON

- 95-0045 75 x 13 mm (AxB)
- 95-0046 100 x 22 mm (AxB)
- 95-0047 120 x 25 mm (AxB)

Scheidenspekula für Laserchirurgie, mit Absaugung am unteren Blatt

Vaginal specula for laser surgery, suctioning from lower blade

Espécúlos vaginales para la cirugía con laser, tubo de succión en la valva inferior

Spécúlums vaginaux pour chirurgie laser, avec embout aspiration sur la valve inférieure

Speculi vaginali per chirurgia laser, aspirazione dalla valva inferiore

Oberfläche geschwärzt
Surface black-finish
Superficie negra
Surface noire
Superficie nera



GRAVE

- 95-0050 75 x 20 mm (AxB)
- ▶ 95-0051 95 x 35 mm (AxB)
- 95-0052 115 x 35 mm (AxB)

Scheidenspekula für Laserchirurgie, mit Absaugung am oberen Blatt

Vaginal specula for laser surgery, suctioning from upper blade

Espécúlos vaginales para la cirugía con laser, tubo de succión en la valva superior

Spécúlums vaginaux pour chirurgie laser, avec embout aspiration sur la valve supérieure

Speculi vaginali per chirurgia laser, aspirazione dalla valva superiore

1/2

GRAVE

- 95-0055 75 x 20 mm (AxB)
- 95-0056 95 x 35 mm (AxB)
- 95-0057 115 x 35 mm (AxB)

Scheidenspekula für Laserchirurgie, mit Absaugung am unteren Blatt

Vaginal specula for laser surgery, suctioning from lower blade

Espécúlos vaginales para la cirugía con laser, tubo de succión en la valva inferior

Spécúlums vaginaux pour chirurgie laser, avec embout aspiration sur la valve inférieure

Speculi vaginali per chirurgia laser, aspirazione dalla valva inferiore

NOTT

- ▶ 95-0146 90 x 30 mm (AxB)
- 95-0147 110 x 30 mm (AxB)

Scheidenspekula
Vaginal specula
Espécúlos vaginales
Spécúlums vaginaux
Speculi vaginali



1/2

DE VILBISS

- 95-0149 102 x 32 mm (AxB)

Scheidenspekulum
Vaginal speculum
Espécúlo vaginal
Spécúlum vaginal
Speculo vaginale



1/2



Scheidenspekula und -halter
 Vaginal Specula and Retractors
 Espéculos y valvas vaginales
 Spéculums et valves vaginaux
 Speculi e valve vaginali

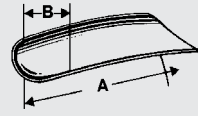

Satz aus je 1 Spekulum und 1 Halter
 Set of 1 speculum and 1 retractor each
 Juego de 1 espéculo y 1 valva
 Jeu de 1 spéculum et 1 valve
 Serie da 1 specolo e 1 valva

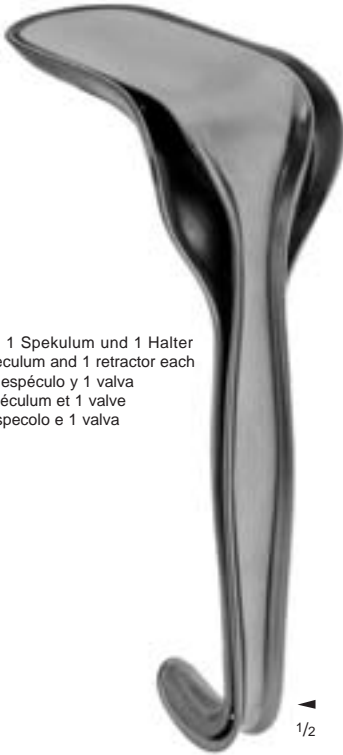

1/2

KALLMORGEN

- ▶ 95-1240 70 x 40 mm (AxB)
- 95-1244 90 x 40 mm (AxB)

Spekula allein
 Specula only
 Espéculos sueltos
 Spéculums seuls
 Solo speculi



1/2

KALLMORGEN

- ▶ 95-1241 70 x 40 mm (AxB)
- 95-1245 90 x 40 mm (AxB)

Halter allein
 Retractors only
 Valvas sueltas
 Valves seules
 Solo valve

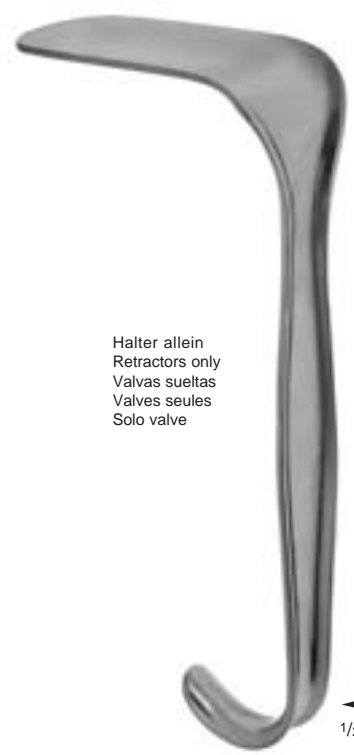

1/2

KALLMORGEN

- ▶ 95-1242 75 x 33 mm (AxB)
- 95-1246 95 x 33 mm (AxB)

Satz aus je 1 Spekulum und 1 Halter
 Set of 1 speculum and 1 retractor each
 Juego de 1 espéculo y 1 valva
 Jeu de 1 spéculum et 1 valve
 Set speculo e valva

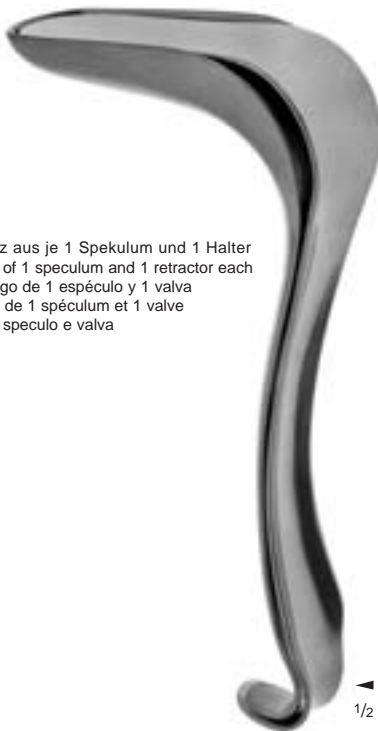

1/2

KRISTELLER

- 95-0296 70 x 27 mm (AxB)
- ▶ 95-0297 80 x 30 mm (AxB)
- 95-0298 90 x 36 mm (AxB)

Spekula allein
 Specula only
 Espéculos sueltos
 Spéculums seuls
 Solo speculi

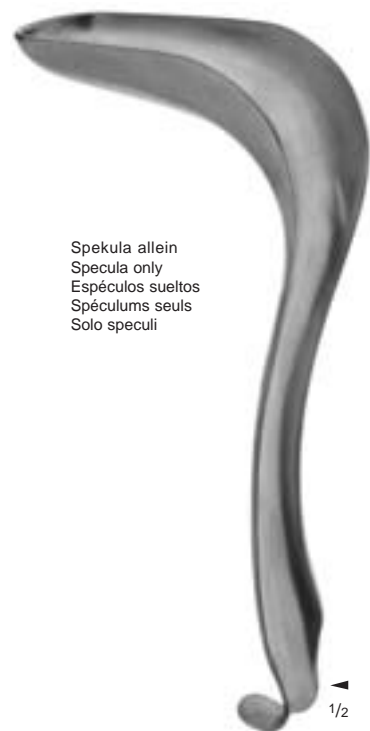

1/2

KRISTELLER

- 95-0290 70 x 27 mm (AxB)
- ▶ 95-0291 80 x 30 mm (AxB)
- 95-0292 90 x 36 mm (AxB)

Halter allein
 Retractors only
 Valvas sueltas
 Valves seules
 Solo valve



1/2

KRISTELLER

- 95-0293 75 x 23 mm (AxB)
- ▶ 95-0294 85 x 26 mm (AxB)
- 95-0295 100 x 32 mm (AxB)

Scheidenspekula und -halter
 Vaginal Specula and Retractors
 Espéculos y valvas vaginales
 Spéculums et valves vaginaux
 Speculi e valve vaginali

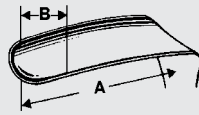

mit konisch verlaufenden Blättern, für Jungfrauen
 with conically shaped blades, virgin sizes
 con valvas de forma cónica, para vírgenes
 avec valves coniques, pour vierges
 con valve coniche, per vergini



KRISTELLER

- ▶ 95-1254 105 x 18 mm (AxB)
- 95-1255 105 x 21 mm (AxB)

Satz aus je 1 Spekulum und 1 Halter
 Set of 1 speculum and 1 retractor each
 Juego de 1 espéculo y 1 valva
 Jeu de 1 spéculum et 1 valve
 Set speculo e valva



KRISTELLER

- ▶ 95-1250 105 x 18 mm (AxB)
- 95-1251 105 x 21 mm (AxB)

Spekula allein
 Specula only
 Espéculos sueltos
 Spéculums seuls
 Solo speculi



KRISTELLER

- ▶ 95-1252 110 x 14 mm (AxB)
- 95-1253 110 x 17 mm (AxB)

Halter allein
 Retractors only
 Valvas sueltas
 Valves seules
 Solo valve



Scheidenspekula und -halter
 Vaginal Specula and Retractors
 Espéculos y valvas vaginales
 Spéculums et valves vaginaux
 Speculi e valve vaginali

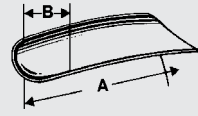

mit flachen Spekula
 specula flat hollow
 espéculos con huecos planos
 avec les spéculums plats
 con speculi piatti



KRISTELLER

- 95-1266 105 x 26 mm (AxB)
- ▶ 95-1267 105 x 28 mm (AxB)
- 95-1268 105 x 33 mm (AxB)

Satz aus je 1 Spekulum und 1 Halter
 Set of 1 speculum and 1 retractor each
 Juego de 1 espéculo y 1 valva
 Jeu de 1 spéculum et 1 valve
 Set speculo e valva



KRISTELLER

- 95-1260 105 x 26 mm (AxB)
- ▶ 95-1261 105 x 28 mm (AxB)
- 95-1262 105 x 33 mm (AxB)

Spekula allein
 Specula only
 Espéculos sueltos
 Spéculums seuls
 Solo speculi



KRISTELLER

- 95-1263 115 x 22 mm (AxB)
- ▶ 95-1264 115 x 24 mm (AxB)
- 95-1265 115 x 29 mm (AxB)

Halter allein
 Retractors only
 Valvas sueltas
 Valves seules
 Solo valve

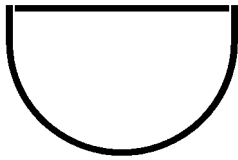
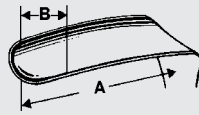

mit tiefen Spekula
 specula deep hollow
 espéculos con huecos profundos
 avec les spéculums profonds
 con speculi profondi



KRISTELLER

- 95-1215 110 x 27 mm (AxB)
- ▶ 95-1216 110 x 30 mm (AxB)
- 95-1217 110 x 36 mm (AxB)

Satz aus je 1 Spekulum und 1 Halter
 Set of 1 speculum and 1 retractor each
 Juego de 1 espéculo y 1 valva
 Jeu de 1 spéculum et 1 valve
 Set speculo e valva



KRISTELLER

- 95-1200 110 x 27 mm (AxB)
- ▶ 95-1201 110 x 30 mm (AxB)
- 95-1202 110 x 36 mm (AxB)

Spekula allein
 Specula only
 Espéculos sueltos
 Spéculums seuls
 Solo speculi



KRISTELLER

- 95-1210 115 x 23 mm (AxB)
- ▶ 95-1211 115 x 26 mm (AxB)
- 95-1212 115 x 32 mm (AxB)

Halter allein
 Retractors only
 Valvas sueltas
 Valves seules
 Solo valve



Scheidenspekula
 Vaginal Specula
 Espéculos vaginales
 Spéculums vaginaux
 Speculi vaginali

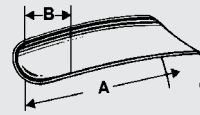

1/2

| | |
|-------------|---|
| SIMS | |
| 95-0257 | 65 x 25 mm (AxB) 70 x 30 mm (AxB) 12,5 cm, 5" |
| <hr/> | |
| 95-0258 | 70 x 30 mm (AxB) 70 x 35 mm (AxB) 15,0 cm, 6" |
| <hr/> | |
| 95-0259 | 85 x 35 mm (AxB) 90 x 40 mm (AxB) 17,5 cm, 7" |

Scheidenspekula, doppelendig
 Vaginal specula, double-ended
 Espéculos vaginales, dobles
 Spéculums vaginaux, doubles
 Speculi vaginali, doppi



1/2

| | |
|----------------|--|
| BREISKY | |
| 95-0275 | 70 x 22 mm (AxB) 76 x 25 mm (AxB) 14,0 cm, 5 1/2" |
| <hr/> | |
| 95-0276 | 76 x 25 mm (AxB) 82 x 30 mm (AxB) 14,0 cm, 5 1/2" |
| <hr/> | |
| ▶ 95-0277 | 82 x 30 mm (AxB) 95 x 38 mm (AxB) 17,0 cm, 6 3/4" |
| <hr/> | |
| 95-0278 | 95 x 38 mm (AxB) 102 x 44 mm (AxB) 17,0 cm, 6 3/4" |

Scheidenspekula, doppelendig
 Vaginal specula, double-ended
 Espéculos vaginales, dobles
 Spéculums vaginaux, doubles
 Speculi vaginali, doppi



1/2

| | |
|----------------|-------------------|
| JACKSON | |
| 95-0271 | 75 x 40 mm (AxB) |
| ▶ 95-0272 | 90 x 40 mm (AxB) |
| 95-0273 | 100 x 40 mm (AxB) |

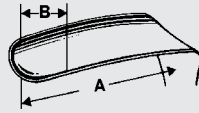

1/2

MATHIEU

- ▶ 95-1310 95 x 13-23 mm (AxB)
- ▶ 95-1311 95 x 16-30 mm (AxB)

Spekula allein
 Specula only
 Espécules sueltos
 Spéculums seuls
 Solo speculi



1/2

MATHIEU

- ▶ 95-1312 100 x 11-21 mm (AxB)
- ▶ 95-1313 100 x 14-27 mm (AxB)

Halter allein
 Retractors only
 Valvas sueltas
 Valves seules
 Solo valve



1/2

DOYEN

- ▶ 95-0215 60 x 30 mm (AxB)
- ▶ 95-0216 70 x 30 mm (AxB)
- ▶ 95-0217 80 x 30 mm (AxB)



Scheidenspekula
Vaginal Specula
Espécules vaginales
Spéculums vaginaux
Speculi vaginali

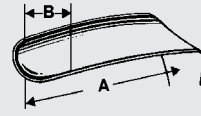

1/2

MATZENAUER

- 95-1350 125 x 15 mm (AxB)
- 95-1351 125 x 20 mm (AxB)
- ▶ 95-1352 125 x 25 mm (AxB)
- 95-1353 125 x 30 mm (AxB)
- 95-1354 125 x 35 mm (AxB)
- 95-1355 125 x 40 mm (AxB)



1/2

LANDAU

- ▶ 95-0285 100 x 28 mm (AxB)
- 95-0286 110 x 38 mm (AxB)



1/2

BREISKY

- 95-0175 100 x 15 mm (AxB)
- 95-0176 100 x 20 mm (AxB)
- ▶ 95-0177 100 x 25 mm (AxB)
- 95-0178 100 x 30 mm (AxB)
- 95-0179 100 x 35 mm (AxB)
- 95-0180 100 x 40 mm (AxB)
- 95-0222 130 x 15 mm (AxB)
- 95-0225 130 x 20 mm (AxB)
- 95-0226 130 x 25 mm (AxB)
- 95-0227 130 x 30 mm (AxB)
- 95-0228 130 x 35 mm (AxB)
- 95-0229 130 x 40 mm (AxB)
- 95-0244 160 x 40 mm (AxB)
- 95-0245 180 x 40 mm (AxB)

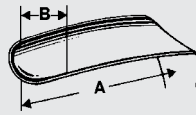

AUVARD-BERLIND
 95-0182
 102 x 45 mm (AxB)
 1,14 kg

Scheidenspekulum mit festem Gewicht und Löchern im Blatt

Vaginal speculum with fixed weight and holes in blade

Espécule vaginal con peso fijo y valva perforada

Spéculum vaginal avec poids fixe et valve à trous

Speculo vaginale con peso fisso e fori sulla lama



AUVARD
 95-0200
 83 x 38 mm (AxB)
 0,91 kg

► 95-0201
 83 x 38 mm (AxB)
 1,14 kg

95-0202
 83 x 38 mm (AxB)
 1,36 kg

Scheidenspekula mit festem Gewicht
 Vaginal specula with fixed weight
 Espécules vaginal con peso fijo
 Spéculums vaginal avec poids fixe
 Speculi vaginali con peso fisso



AUVARD
 95-1290
 102 x 45 mm (AxB)
 1,14 kg

Scheidenspekulum mit abnehmbarem Gewicht

Vaginal speculum with detachable weight

Espécule vaginal con peso desmontable

Spéculum vaginal avec poids démontable

Speculo vaginale a peso smontabile



Scheidenspekula
Vaginal Specula
Espécules vaginales
Spéculums vaginaux
Speculi vaginali

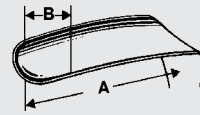

95-2001

95-2002
0,4 kg

95-2003
0,8 kg

SCHERBACK
95-2000

Satz, bestehend aus:
95-2001 1 Griff
95-2002 1 Gewicht 0,4 kg
95-2005 1 Blatt 80 x 30 mm
95-2006 1 Blatt 85 x 35 mm
95-2007 1 Blatt 85 x 40 mm
95-2008 1 Blatt 55 x 40-60 mm
95-2009 1 Blatt 70 x 45-70 mm



95-2005
80 x 30 mm (AxB)



95-2006
85 x 35 mm (AxB)



95-2007
85 x 40 mm (AxB)



95-2008
55 x 40-60 mm (AxB)



95-2009
70 x 45-70 mm (AxB)

Set, consisting of:
95-2001 1 Handle
95-2002 1 Weight 0.4 kg
95-2005 1 Blade 80 x 30 mm
95-2006 1 Blade 85 x 35 mm
95-2007 1 Blade 85 x 40 mm
95-2008 1 Blade 55 x 40-60 mm
95-2009 1 Blade 70 x 45-70 mm

Jeu, composé de:
95-2001 1 Manche
95-2002 1 Poids 0,4 kg
95-2005 1 Valve 80 x 30 mm
95-2006 1 Valve 85 x 35 mm
95-2007 1 Valve 85 x 40 mm
95-2008 1 Valve 55 x 40-60 mm
95-2009 1 Valve 70 x 45-70 mm

Juego, compuesto de:
95-2001 1 Mango
95-2002 1 Peso 0,4 kg
95-2005 1 Valva 80 x 30 mm
95-2006 1 Valva 85 x 35 mm
95-2007 1 Valva 85 x 40 mm
95-2008 1 Valva 55 x 40-60 mm
95-2009 1 Valva 70 x 45-70 mm

Serie, composta da:
95-2001 1 Manico
95-2002 1 Peso 0,4 kg
95-2005 1 Valva 80 x 30 mm
95-2006 1 Valva 85 x 35 mm
95-2007 1 Valva 85 x 40 mm
95-2008 1 Valva 55 x 40-60 mm
95-2009 1 Valva 70 x 45-70 mm



WEISSBARTH
95-0299
80 x 42 mm (AxB)

Scheidenspekulum mit abnehmbarem Auffangsieb
Vaginal speculum with removable strainer and perforated bottom
Espécule vaginal con tamiz desmontable
Spéculum vaginal avec tamis démontable
Speculo vaginale con filtro smontabile et fondo forato

Endospekula
Endospecula
Endoespécules
Endospéculum
Endospeculi

Uterus-Dilatator
Uterine Dilator
Dilatador uterino
Dilatateurs du col de l'utérus
Dilatatori uterini



KOGAN
95-0482
24 cm, 9 1/2"

Endospekulum für Harnröhre und Cervix, ohne Sperre
Endospeculum for cervix and urethra, without catch
Endoespécule para uretra y cerviz, sin cierre
Endospéculum pour urètre et col utérin, sans verrou
Endospeculo per cervice e uretra, senza cremagliera



KOGAN
95-0483
24 cm, 9 1/2"

Endospekulum für Harnröhre und Cervix, mit Skalensperre und Fixierschraube
Endospeculum for cervix and urethra, with scale-ratchet and fixing screws
Endoespécule para uretra y cerviz, con cierre graduado y tornillo fijador
Endospéculum pour urètre et col utérin crémaillère à vis
Endospeculo per cervice e uretra, con nottolino graduato e vite di fissaggio

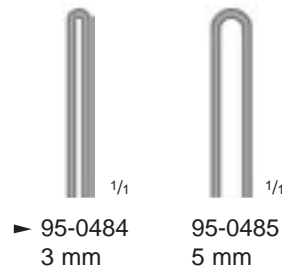

► 95-0484 3 mm
95-0485 5 mm



KOGAN
95-0484
- 95-0485
27 cm, 10 3/4"

Endospekula für Harnröhre und Cervix, mit Sperre
Endospecula for cervix and urethra, with catch
Endoespécules para uretra y cerviz, con cierre
Endospéculum pour urètre et col utérin avec crémaillère, avec verrou
Endospecoli per cervice e uretra, con cremagliera



GOODELL
95-0480
34 cm, 13 1/2"

Uterus-Dilatator
Uterine dilator
Dilatador uterino
Dilatateur du col de l'utérus
Dilatatore uterino



Uterus-Dilatatoren
 Uterine Dilators
 Dilatadores uterinos
 Dilatateurs du col de l'utérus
 Dilatatori uterini



HEGAR

- 95-0321 ø 1,0 mm
 - 95-0322 ø 2,0 mm
 - 95-0323 ø 3,0 mm
 - 95-0324 ø 4,0 mm
 - 95-0325 ø 5,0 mm
 - 95-0326 ø 6,0 mm
 - 95-0327 ø 7,0 mm
 - 95-0328 ø 8,0 mm
 - 95-0329 ø 9,0 mm
 - 95-0330 ø 10,0 mm
 - 95-0331 ø 11,0 mm
 - ▶ 95-0332 ø 12,0 mm
 - 95-0333 ø 13,0 mm
 - 95-0334 ø 14,0 mm
 - 95-0335 ø 15,0 mm
 - 95-0336 ø 16,0 mm
 - 95-0337 ø 17,0 mm
 - 95-0338 ø 18,0 mm
 - 95-0339 ø 19,0 mm
 - 95-0340 ø 20,0 mm
 - 95-0341 ø 21,0 mm
 - 95-0342 ø 22,0 mm
 - 95-0343 ø 23,0 mm
 - 95-0344 ø 24,0 mm
 - 95-0345 ø 25,0 mm
 - 95-0346 ø 26,0 mm
- 18,5 cm, 7 1/4"

mit glattem Muldengriff
 with sloped handle
 con mango aplanado
 à manche aplati
 con manico iclinato

HEGAR

- 95-1321 ø 1,5 mm
 - 95-1322 ø 2,5 mm
 - 95-1323 ø 3,5 mm
 - 95-1324 ø 4,5 mm
 - 95-1325 ø 5,5 mm
 - 95-1326 ø 6,5 mm
 - 95-1327 ø 7,5 mm
 - 95-1328 ø 8,5 mm
 - 95-1329 ø 9,5 mm
 - 95-1330 ø 10,5 mm
 - 95-1331 ø 11,5 mm
 - ▶ 95-1332 ø 12,5 mm
 - 95-1333 ø 13,5 mm
 - 95-1334 ø 14,5 mm
 - 95-1335 ø 15,5 mm
 - 95-1336 ø 16,5 mm
 - 95-1337 ø 17,5 mm
- 18,5 cm, 7 1/4"

mit glattem Muldengriff
 with sloped handle
 con mango aplanado
 à manche aplati
 con manico iclinato

HEGAR

- 95-0379 ø 2,0 / 3,0 mm
 - 95-0381 ø 3,0 / 4,0 mm
 - 95-0382 ø 5,0 / 6,0 mm
 - 95-0383 ø 7,0 / 8,0 mm
 - 95-0384 ø 9,0 / 10,0 mm
 - ▶ 95-0385 ø 11,0 / 12,0 mm
 - 95-0386 ø 13,0 / 14,0 mm
 - 95-0387 ø 15,0 / 16,0 mm
 - 95-0388 ø 17,0 / 18,0 mm
 - 95-0391 ø 19,0 / 20,0 mm
 - 95-0396 ø 21,0 / 22,0 mm
 - 95-0397 ø 23,0 / 24,0 mm
 - 95-0399 ø 25,0 / 26,0 mm
- 20 cm, 8"

Uterus-Dilatatoren
 Uterine Dilators
 Dilatadores uterinos
 Dilatateurs du col de l'utérus
 Dilatatori uterini



1/4

▲
 mit glattem Muldengriff
 with sloped handle
 con mango aplanado
 à manche aplati
 con manico iclinato
 ▼



1/4



1/4

HEGAR 95-0360

Dilatatorensatz, bestehend aus:

- 95-0324 - 95-0337 14 Dilatatorensätze Ø 4-17 mm
- 95-0364 1 Lagerungssieb für Dilatatorensätze Ø 4-12 mm
- 95-0365 1 Lagerungssieb für Dilatatorensätze Ø 13-17 mm
- 95-0366 1 Metallkoffer mit Scharnierdeckel 205 x 105 x 45 mm (BxTxH)

Dilator set, consisting of:

- 95-0324 - 95-0337 14 Dilators Ø 4-17 mm
- 95-0364 1 Rack for dilators Ø 4-12 mm
- 95-0365 1 Rack for dilators Ø 13-17 mm
- 95-0366 1 Metal case with hinged lid 205 x 105 x 45 mm (wxdxh)

Juego de dilataadores, compuesto de:

- 95-0324 - 95-0337 14 Dilataadores de Ø 4-17 mm
- 95-0364 1 Soporte para dilataadores de Ø 4-12 mm
- 95-0365 1 Soporte para dilataadores de Ø 13-17 mm
- 95-0366 1 Estuche de metal con tapa de bisagra 205 x 105 x 45 mm

Jeu de dilataateurs, composé de:

- 95-0324 - 95-0337 14 Dilataateurs de Ø 4-17 mm
- 95-0364 1 chevalet pour dilataateurs de Ø 4-12 mm
- 95-0365 1 chevalet pour dilataateurs de Ø 13-17 mm
- 95-0366 1 Boîte métal avec couvercle à charnière 205 x 105 x 45 mm

Set dilatori, composto da:

- 95-0324 - 95-0337 14 Dilatori Ø 4-17 mm
- 95-0364 1 Supporto di Ø 4-12 mm
- 95-0365 1 Supporto di Ø 13-17 mm
- 95-0366 1 Scatola metallica con coperchio a cerniera 205 x 105 x 45 mm

HEGAR 95-0362

Dilatatorensatz, bestehend aus:

- 95-0321 - 95-0346 26 Dilatatorensätze Ø 1-26 mm
- 95-0367 1 Lagerungssieb für Dilatatorensätze Ø 1-17 mm
- 95-0368 1 Lagerungssieb für Dilatatorensätze Ø 18-26 mm
- 95-0369 1 Metallkoffer mit Scharnierdeckel 310 x 210 x 55 mm (BxTxH)

Dilator set, consisting of:

- 95-0321 - 95-0346 26 Dilators Ø 1-26 mm
- 95-0367 1 Rack for dilators Ø 1-17 mm
- 95-0368 1 Rack for dilators Ø 18-26 mm
- 95-0369 1 Metal case with hinged lid 310 x 210 x 55 mm (wxdxh)

Juego de dilataadores, compuesto de:

- 95-0321 - 95-0346 26 Dilataadores de Ø 1-26 mm
- 95-0367 1 Soporte para dilataadores de Ø 1-17 mm
- 95-0368 1 Soporte para dilataadores de Ø 18-26 mm
- 95-0369 1 Estuche de metal con tapa de bisagra 310 x 210 x 55 mm

Jeu de dilataateurs, composé de:

- 95-0321 - 95-0346 26 Dilataateurs de Ø 1-26 mm
- 95-0367 1 chevalet pour dilataateurs de Ø 1-17 mm
- 95-0368 1 chevalet pour dilataateurs de Ø 18-26 mm
- 95-0369 1 Boîte métal avec couvercle à charnière 310 x 210 x 55 mm

Set dilatori, composto da:

- 95-0321 - 95-0346 26 Dilatori Ø 1-26 mm
- 95-0367 1 Supporto di Ø 1-17 mm
- 95-0368 1 Supporto di Ø 18-26 mm
- 95-0369 1 Scatola metallica con coperchio a cerniera 310 x 210 x 55 mm

HEGAR 95-0380

Dilatatorensatz, bestehend aus:

- 95-0381 - 95-0388 8 Dilatatorensätze Ø 3/4 - 17/18 mm
- 95-0389 1 auskochbare Segeltuchrolle

Dilator set, consisting of:

- 95-0381 - 95-0388 8 Dilators Ø 3/4 - 17/18 mm
- 95-0389 1 Boilable canvas roll

Juego de dilataadores, compuesto de:

- 95-0381 - 95-0388 8 Dilataadores de Ø 3/4 - 17/18 mm
- 95-0389 1 Bolsa de tela esterilizable por ebullición

Jeu de dilataateurs, composé de:

- 95-0381 - 95-0388 8 Dilataateurs de Ø 3/4 - 17/18 mm
- 95-0389 1 Trousse stérilisable par ébullition

Set dilatori, composto da:

- 95-0381 - 95-0388 8 Dilatori Ø 3/4 - 17/18 mm
- 95-0389 1 Borsa telata sterilizzabile



Uterussonden
Uterine Probes
Histerómetros
Hystéromètres
Isterometri

ø 4,0 mm



1/2

SIMS
95-0390
34 cm, 13 1/2"

mit Zolleinteilung,
biegsam, versilbert

graduated in inch,
malleable, silver-plated

graduado en pulgadas,
maleable, plateado

gradué, en pouces, malléable,
argent

graduato in pollice, malleabile,
placcato in argento

ø 4,0 mm



1/2

SIMS
95-0392
34 cm, 13 1/2"

mit Zentimetereinteilung,
biegsam, versilbert

graduated in centimeters,
malleable, silver-plated

graduado en centímetros,
maleable, plateado

gradué en cm, malléable,
argent

graduato in cm, malleabile,
placcato in argento

ø 4,0 mm



1/2

SIMS
95-0405
34 cm, 13 1/2"

mit Zentimetereinteilung,
biegsam, 18/8 Stahl

graduated in centimeters,
malleable, 18/8 steel

graduado en centímetros,
maleable, acero 18/8

gradué en cm, malléable,
acier inox

graduato in cm, malleabile,
acciaio inox 18/8

ø 4,0 mm



1/2

SIMPSON
95-0401
34 cm, 13 1/2"

mit Zentimetereinteilung,
biegsam, versilbert

graduated in centimeters,
malleable, silver-plated

graduado en centímetros,
maleable, plateado

gradué en cm, malléable,
argent

graduato in cm, malleabile,
placcato in argento

ø 4,0 mm



1/2

VALLEIX
95-0406
29 cm, 11 1/2"

mit Zentimetereinteilung und
Schieber, biegsam, versilbert

graduated in centimeters, with
slider, malleable, chromium plated

graduado en centímetros con
un cursor, maleable, cromado

gradué en cm avec curseur,
malléable, chromé

graduato in cm, con cursore,
malleabile, cromato

Uterus-Depressor
 Uterine Depressor
 Depresores uterinos
 Dépresseur utérin
 Depressori uterini

Tamponadeführer
 Uterine Gauze Packer
 Conductor de tapónes
 Conducteur porte-tampon
 Porta garza uterino

IUP (Intrauterinpeßsar)- Faßzangen
 IUD (Intra Uterine Device)- Forceps
 Pinzas-DIU (Dispositivo Intra-Uterino)
 Pincas-DIU
 Pinza intra-uterina



ø 9,0 mm



1/2

95-0408
 20,5 cm, 8"

Konisationsstift
 Conisation pin
 Clavija cónica
 Conique
 Punta conica



24 mm

28 mm

1/2

BRAUN
 95-0410
 27 cm, 10 3/4"

Uterus-Depressor
 Uterine depressor
 Depresor uterino
 Dépresseur utérin
 Depressori uterini



1/2

AMANN
 95-0414
 33 cm, 13"

Tamponadeführer
 Uterine gauze packer
 Conductor de tapónes
 Conducteur porte-tampon
 Porta garza uterino



1/1



1/2

► 95-0300 ø 3 mm x 220 mm
 95-0301 ø 3 mm x 285 mm

IUP (Intrauterinpeßsar)- Faßzangen
 mit flexiblem Schaft

IUD (Intra Uterine Device)- Forceps
 with flexible shaft

Pinzas-DIU (Dispositivo Intra-Uterino)
 con vástago flexible

Pince-DIU tige flexible

Pinza intra-uterina con asta flessibile



Instrumente für Laserchirurgie, Oberfläche geschwärzt
 Instruments for Laser Surgery, surface black-finish
 Instrumentos para la cirugía laser, superficie negra
 Instruments pour la chirurgie laser, surface noire
 Strumenti per chirurgia laser, superficie nera



1/1

Scheidenspekula für Laserchirurgie siehe Seite 433!
 Vaginal specula for laser surgery see page 433!
 Espécules vaginales para la cirugía laser vean pagina 433!
 Spéculum vaginaux pour la chirurgie laser voir page 433!
 Specoli vaginali per chirurgia laser vedi pagina 433!



1/1

► 95-0487
3 mm



1/1

95-0488
5 mm



1/1



1/1



1/2

95-0486
25 cm, 10"

Lateral-Spekulum
 Lateral speculum
 Espéculo lateral
 Speculum latéral
 Speculo laterale



1/2

KOGAN
 95-0487
 - 95-0488
 27 cm, 10³/₄"

Endospekula für Harnröhre und Cervix
 Endospecula for cervix and urethra
 Endoespéculos para cerviz y uretra
 Spéculum pour urètre et col utérin
 Endospeculi per cervic ed uretra



1/2

95-0740
26,5 cm, 10¹/₂"

Meßinstrument
 Measuring instrument
 Instrumento para medir
 Instrument pour mesurer
 Strumento per misure



1/2

95-0741
28,5 cm, 11¹/₄"

Meßinstrument
 Measuring instrument
 Instrumento para medir
 Instrument pour mesurer
 Strumento per misure



1/1



1/1



1/1



1/1



1/1



1/2

95-0745
24,5 cm, 9³/₄"

Häkchen
Hook
Gancho
Crochet
Uncino



1/2

EMMET
95-0746
24,5 cm, 9³/₄"

Häkchen
Hook
Gancho
Crochet
Uncino



1/2

95-0747
24,5 cm, 9³/₄"

Häkchen
Hook
Gancho
Crochet
Uncino



1/2

95-0748
23,5 cm, 9¹/₄"

Häkchen
Hook
Gancho
Crochet
Uncino



1/2

95-0749
26 cm, 10¹/₄"

Häkchen
Hook
Gancho
Crochet
Uncino



Instrumente für Laserchirurgie, Oberfläche geschwärzt
Instruments for Laser Surgery, surface black-finish
Instrumentos para la cirugía laser, superficie negra
Instruments pour la chirurgie laser, surface noire
Strumenti per chirurgia laser, superficie nera



95-0750
24,5 cm, 9³/₄"

Meßsonde
Measuring probe
Sonda para medir
Sonde pour mesurer
Sonda per misura

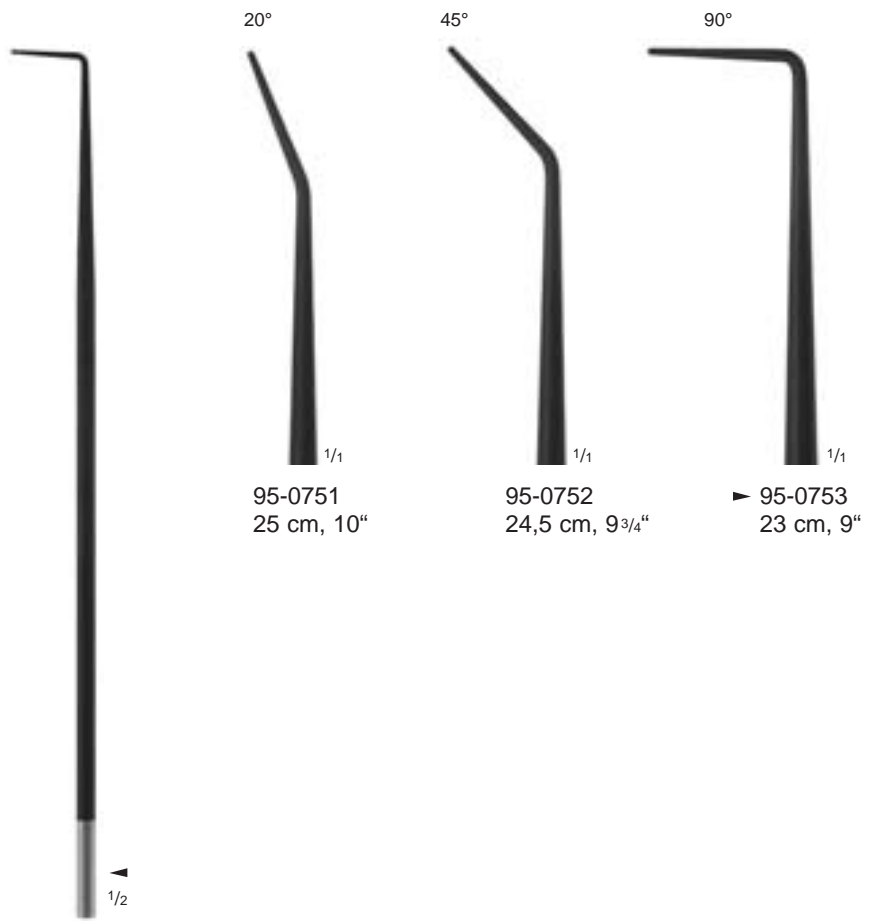

95-0751
- 95-0753

Sonden
Probes
Sondas
Sondes
Sonde



95-0755
 27 cm, 10^{3/4}"

Tiefenmesser
 Depth ruler
 Sonda para medir la profundidad
 Instrument de mesure pour la profondeur
 Sonda per misurare la profondità

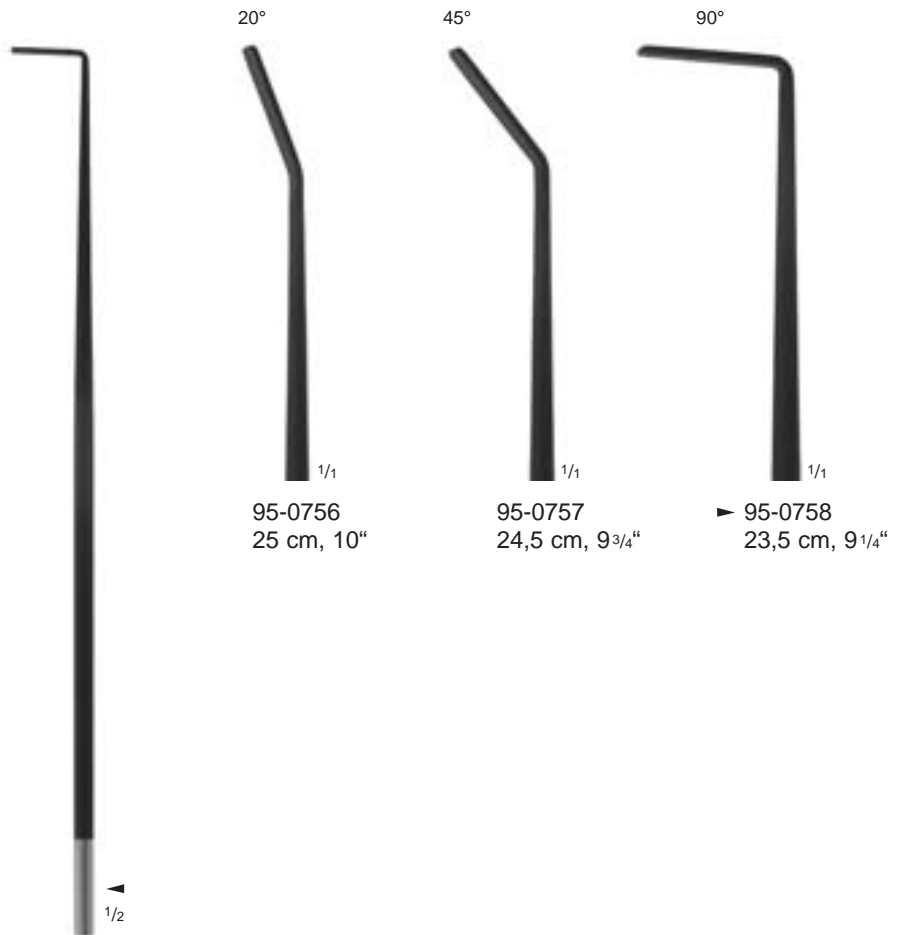

95-0756
 25 cm, 10"

95-0757
 24,5 cm, 9^{3/4}"

▶ 95-0758
 23,5 cm, 9^{1/4}"

95-0756
 - 95-0758

Sonden
 Probes
 Sondas
 Sondes
 Sonda



Hakenzangen
Uterine Tenaculum Forceps
Pinzas para coger el cuello del útero
Pincés pour abaissement du col de l'utérus
Pinze per abbassare il collo dell'utero



STAUDE-
MOORE
96-0320
17 cm, 6³/₄"

1/2



BARRETT
96-0300
18 cm, 7"

1/2



ADAIR
10-0188
18,5 cm, 7¹/₄"

1/2



SCHRÖDER
96-0313
25,5 cm, 10"

1/2



SCHRÖDER
96-0309
25 cm, 10"

1/2



BRAUN
96-0310
25 cm, 10"

1/2

Hakenzangen
Uterine Tenaculum Forceps
Pinzas para coger el cuello del útero
Pinces pour abaissement du col de l'utérus
Pinze per abbassare il collo dell'utero



1/2

POZZI
96-0303
25,5 cm, 10"

kräftiges Modell
heavy pattern
modelo fuerte
modèle fort
modello pesante



1/2

DUPLAY
96-0315
28,5 cm, 11 1/4"



1/2

HULKA
96-0305
29 cm, 11 1/2"



1/2

HULKA-KENWICK
96-0306
29 cm, 11 1/2"



Hakenzangen
 Uterine Tenaculum Forceps
 Pinzas para coger el cuello del útero
 Pinces pour abaissement du col de l'utérus
 Pinze per abbassare il collo dell'utero

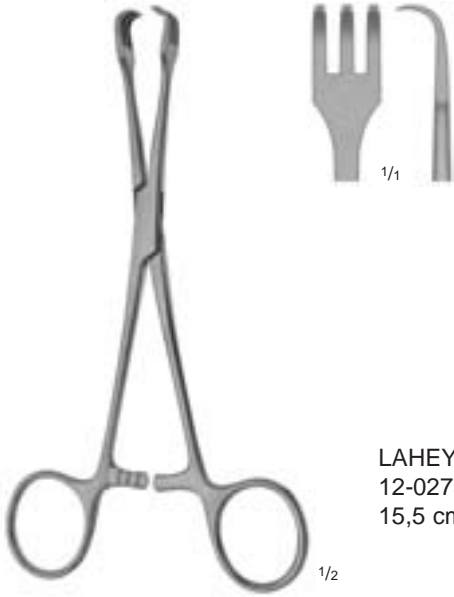

LAHEY
 12-0275
 15,5 cm, 6"

1/2

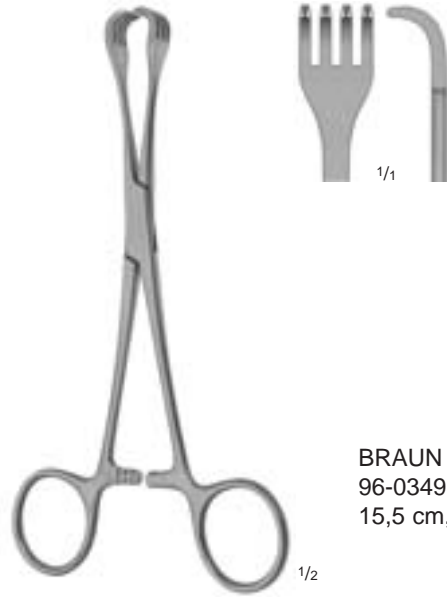

BRAUN
 96-0349
 15,5 cm, 6"

1/2



SCHRÖDER
 96-0350
 25 cm, 10"

gerade
 straight
 recta
 droits
 retta

1/2



SCHRÖDER
 96-0351
 25 cm, 10"

aufgebogen
 curved on flat
 curva sobre el plano
 courbe sur le plat
 curva su un lato

1/2



SCHRÖDER
 96-0352
 25 cm, 10"

seitwärts gebogen
 curved sideways
 curva lateral
 courbe sur le côté
 curva sul fianco

1/2

Hakenzangen

Uterine Tenaculum Forceps

Pinzas para coger el cuello del útero

Pinces pour abaissement du col de l'utérus

Pinze per abbassare il collo dell'utero



1/1



1/1



1/1



1/2

CZERNY
96-0355
21 cm, 8¹/₄"



1/2

PRATT
96-0357
26 cm, 10¹/₄"



1/2

PRATT
96-0740
27,5 cm, 10³/₄"



Hakenzangen

Uterine Tenaculum Forceps

Pinzas para coger el cuello del útero

Pinces pour abaissement du col de l'utérus

Pinze per abbassare il collo dell'utero



JACOBS
96-0380
21 cm, 8 1/4"

gerade
straight
recta
droit
retta

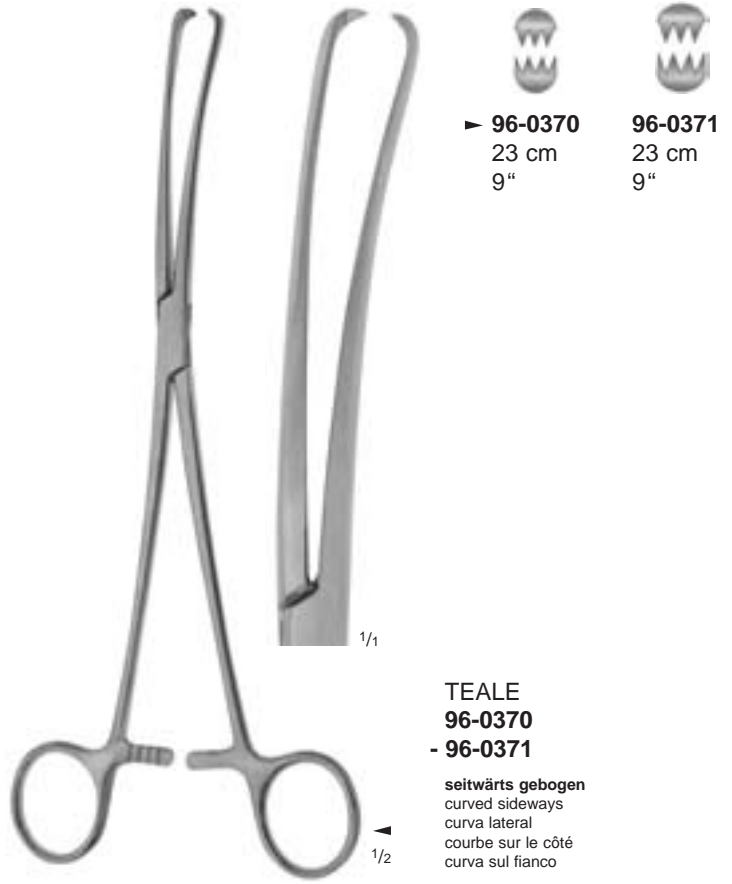

► **96-0370**
23 cm
9"

96-0371
23 cm
9"

TEALE
96-0370
- **96-0371**

seitwärts gebogen
curved sideways
curva lateral
courbe sur le côté
curva sul fianco

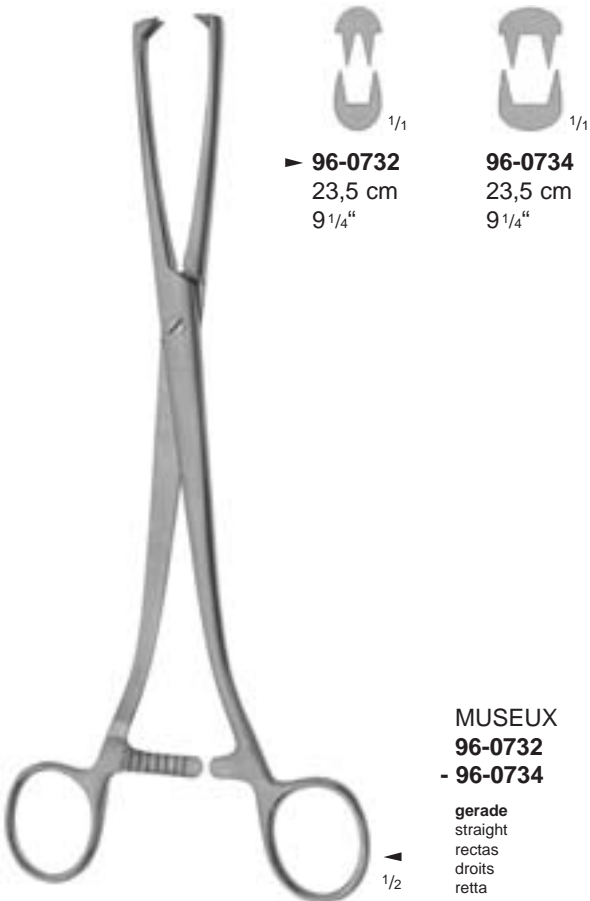

► **96-0732**
23,5 cm
9 1/4"

96-0734
23,5 cm
9 1/4"

MUSEUX
96-0732
- **96-0734**

gerade
straight
rectas
droits
retta



► **96-0733**
23,5 cm
9 1/4"

96-0735
23,5 cm
9 1/4"

MUSEUX
96-0733
- **96-0735**

seitwärts gebogen
curved sideways
curva lateral
courbe sur le côté
curva sul fianco

Polypen- und Ovarienzangen

Polypus and Ovum Forceps

Pinzas para pólipos uterinos y ovarios

Pinces à polypes et ovaires

Pinze per polipi e ovaie



1/2

DOYEN
16-0306
18,5 cm, 7 1/4"



1/2

HEYWOOD-SMITH
97-0452
25 cm, 10"



1/2

NOTO
97-0456
27 cm, 10 3/4"



1/2

KELLY
97-0450
31 cm, 12 1/4"



Uterusfaßzangen

Uterine Elevating Forceps
Pinzas para el útero
Pincas hystérolabes
Pinze per afferrare l'utero

Myomheber

Myoma Screws
Tirabuzóns para mioma
Tracteurs pour fibrome
Succhielli per fibroma



1/1



1/1

mit beweglichen Mauftteilen
with movable jaws
con mandibula movable
avec mors mobiles
con mandibole mobili



1/2

DOYEN

96-0749

17 cm, 6^{3/4}"

Myomheber ø 20 mm
Myoma screw ø 20 mm
Tirabuzón para mioma ø 20 mm
Tracteur pour fibrome ø 20 mm
Succhiello per fibroma ø 20 mm



1/2

SOMER

96-0800

23 cm, 9"

Uterusfaßzange
Uterine elevating forceps
Pinza para el útero
Pince hystérolabe
Pinza per afferrare l'utero



1/2

COLLIN

96-0817

26,5 cm, 10^{1/2}"

Uterusfaßzange
Uterine elevating forceps
Pinza para el útero
Pince hystérolabe
Pinza per afferrare l'utero



1/2

DOYEN

96-0750

17 cm, 6^{3/4}"

Myomheber ø 29 mm
Myoma screw ø 29 mm
Tirabuzón para mioma ø 29 mm
Tracteur pour fibrome ø 29 mm
Succhiello per fibroma ø 29 mm

Biopsieküretten

Biopsy Curettes

Curetas para biopsia

Curettes pour biopsie

Curette per biopsia



RANDALL
95-0809
25 cm, 10"

Endometrium-Saug-Biopsiekürette

Endometrial suction biopsy curette

Cureta aspiradora para biopsia endo-uterina

Curette aspiratrice pour biopsie de l'endomètre

Curetta aspirante per la biopsia dell'endometrio



NOVAK
95-0810
25 cm, 10"

Endometrium-Saug-Biopsiekürette

Endometrial suction biopsy curette

Cureta aspiradora para biopsia endo-uterina

Curette aspiratrice pour biopsie de l'endomètre

Curetta aspirante per la biopsia dell'endometrio



MOD. MÜNCHEN
95-0812
27 cm, 10³/₄"

Endometrium-Strichkürette

Endometrial biopsy curette

Cureta para biopsia endo-uterina

Curette à biopsie de l'endomètre

Curetta per la biopsia dell'endometrio



KEVOURKIAN-YOUNGE
95-0764
28 cm, 11"

Endocervix-Biopsiekürette

Endocervical biopsy curette

Cureta para biopsia endo-cerviz

Curette à biopsie endo-cervicale

Curetta per la biopsia endo-cervicale



KEVOURKIAN-YOUNGE
95-0765
28 cm, 11"

Endocervix-Biopsiekürette

Endocervical biopsy curette

Cureta para biopsia endo-cerviz

Curette à biopsie endo-cervicale

Curetta per la biopsia endo-cervicale



Biopsieküretten

Biopsy Curettes

Curetas para biopsia

Curettes pour biopsie

Curette per biopsia

Uterus-Biopsiezange

Cervical Biopsy and Specimen Forceps

Pinza saca-bocados para biopsia

Pince emporte-pièces à biopsie

Pinza per la biopsia cervicale e da prelievo

ø 5 mm



1/1

95-1101

28,5 cm, 11 1/4"

ø 7 mm



1/1

▶ **95-1102**

28,5 cm, 11 1/4"

ø 9 mm



1/1

95-1103

28,5 cm, 11 1/4"

biegsam • malleable • maleables • malléables • malleabili

ø 5 mm



1/1

95-1105

28,5 cm, 11 1/4"

ø 7 mm



1/1

95-1106

28,5 cm, 11 1/4"

ø 9 mm



1/1

95-1107

28,5 cm, 11 1/4"

starr • rigid • rígidas • rigides • rigidi



1/2

MILAN

95-1101

- **95-1107**

Endocervix-Biopsieküretten, Arbeitsteil bestehend aus mehreren, untereinander angeordneten konkaven Rundmessern

Endocervical biopsy curettes, working portion consisting of several concave-shaped circular knives, arranged one beneath the other

Cureta para biopsia endo-cervix, con cuchillitos redondos colocados uno sobre otro, concavos

Curettes pour biopsie endo-cervicale constituées de plusieurs parties tranchantes circulaires concaves

Curette per la biopsia endo-cervicale, con parte attiva formata da dischi, taglienti concavi sistemati l'uno sull'altro



1/1



1/2

THOMS-GAYLOR

95-0550

24 cm, 9 1/2"

Uterus-Biopsiezange

Cervical biopsy and specimen forceps

Pinza saca-bocados para biopsia

Pince emporte-pièces à biopsie

Pinza per la biopsia cervicale e da prelievo

Uterus-Biopsiezangen

Cervical Biopsy and Specimen Forceps

Pinzas saca-bocados para biopsia

Pinces emporte-pièces à biopsie

Pinze per la biopsia cervicale e da prelievo



SCHUBERT
95-0670
28,5 cm, 11 1/4"



SCHUBERT
95-0650
26 cm, 10 1/4"



VAN DOREN
95-0652
25 cm, 10"



Uterus-Biopsiezangen

Cervical Biopsy and Specimen Forceps

Pinzas saca-bocados para biopsía

Pinces emporte-pièces à biopsie

Pinze per la biopsia cervicale e da prelievo

← 185 mm →

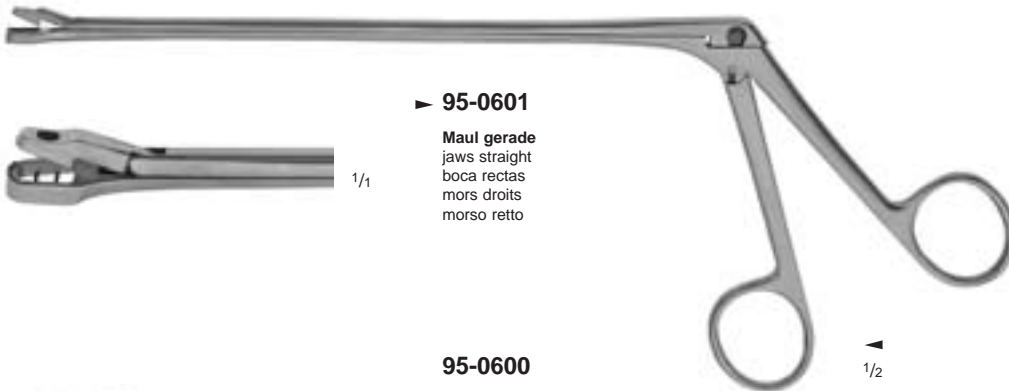

► 95-0601

Maul gerade
jaws straight
boca rectas
mors droits
morso retto



WITTNER
95-0600
- **95-0601**

95-0600

Maul nach links gebogen
jaws curved to left
boca curva hacia la izquierda
mors courbes à gauche
morso curve a sinistra



◄ 1/2

← A →



HARTMANN

- **95-0660** 175 mm (A)
- 95-0661** 210 mm (A)
- 95-0662** 250 mm (A)



◄ 1/2

← 200 mm →



BERGER
95-0659



1/2

Uterus-Biopsiezangen

Cervical Biopsy and Specimen Forceps

Pinzas saca-bocados para biopsia

Pinces emporte-pièces à biopsie

Pinze per la biopsia cervicale e da prelievo

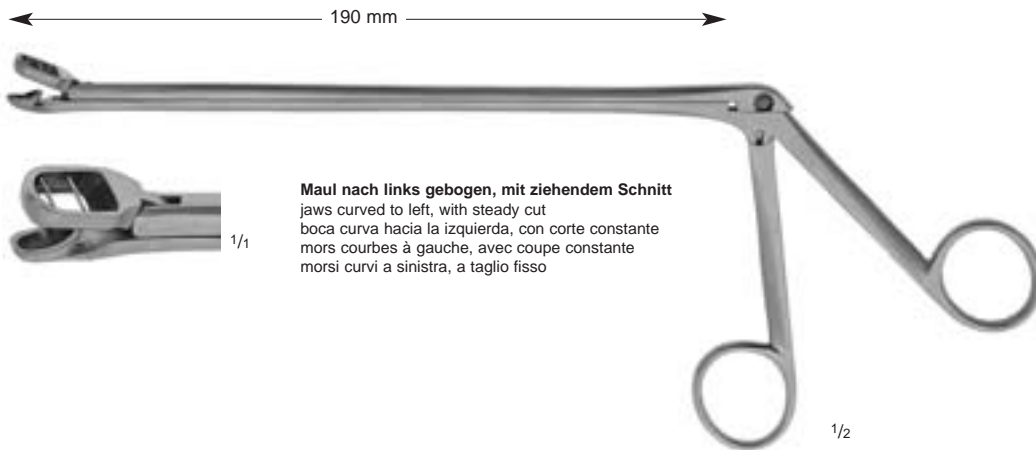

Maul nach links gebogen, mit ziehendem Schnitt
jaws curved to left, with steady cut
boca curva hacia la izquierda, con corte constante
mors courbes à gauche, avec coupe constante
morsi curvi a sinistra, a taglio fisso

ALEXANDER
95-0604

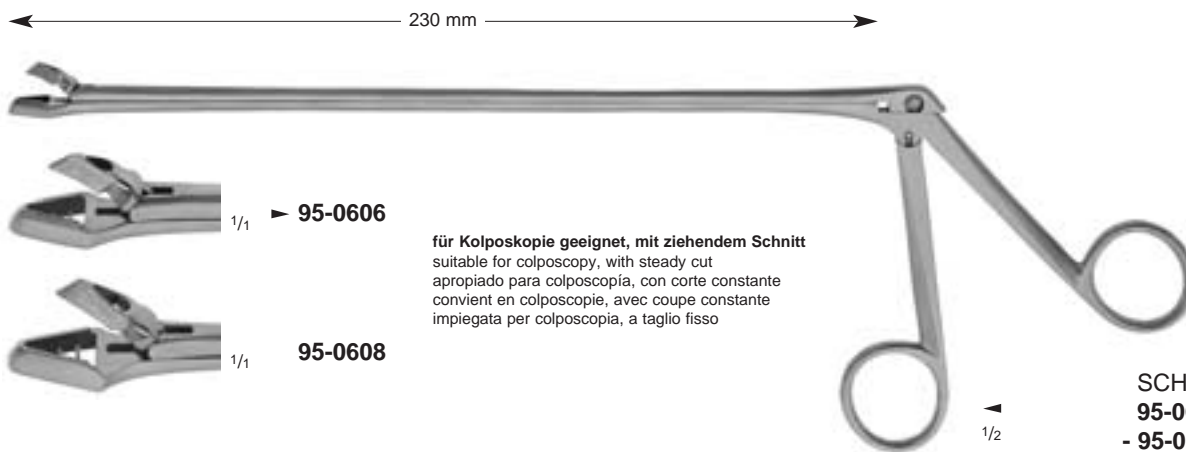

für Kolposkopie geeignet, mit ziehendem Schnitt
suitable for colposcopy, with steady cut
apropiado para colposcopia, con corte constante
convient en colposcopie, avec coupe constante
impiegata per colposcopia, a taglio fisso

SCHUMACHER
95-0606
- 95-0608

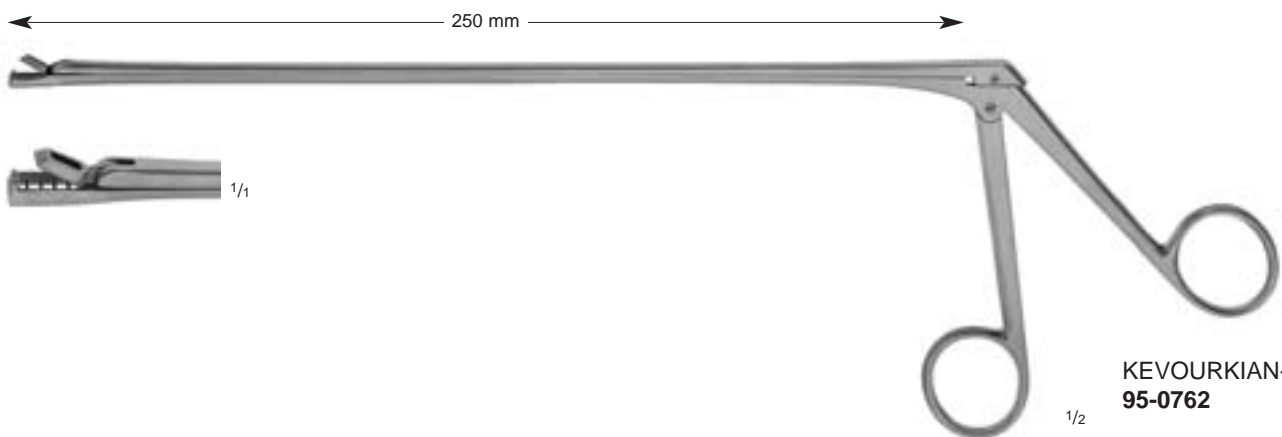

KEVOURKIAN-YOUNGE
95-0762



Uterus-Biopsiezangen

Cervical Biopsy and Specimen Forceps

Pinzas saca-bocados para biopsía

Pinces emporte-pièces à biopsie

Pinze per la biopsia cervicale e da prelievo

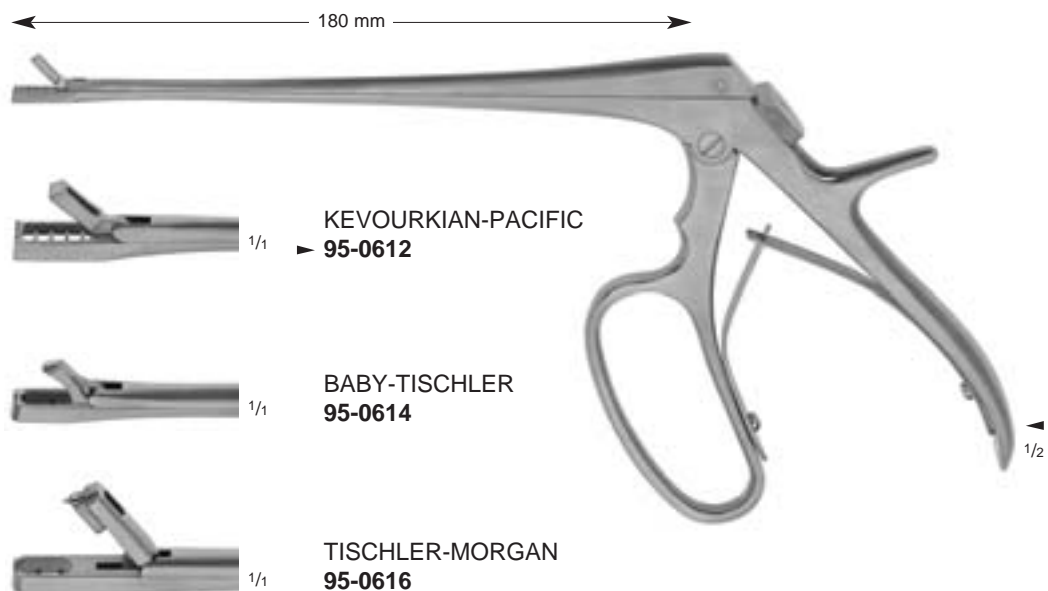
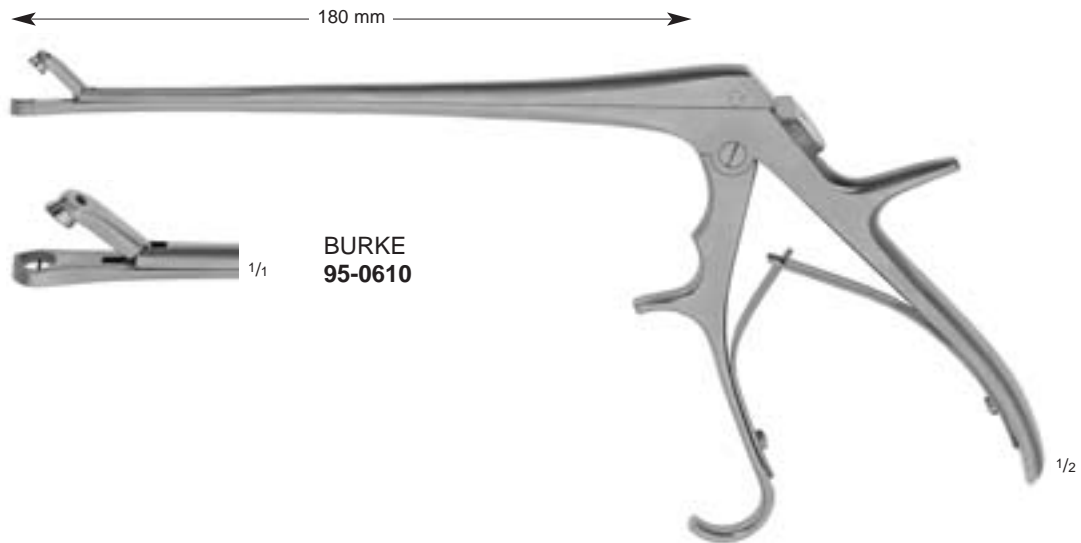

Uterus-Biopsiezangen

Cervical Biopsy and Specimen Forceps

Pinzas saca-bocados para biopsia

Pinces emporte-pièces à biopsie

Pinze per la biopsia cervicale e da prelievo



Instrument komplett
Complete instrument
Instrumento completo
Instrument complet
Strumento completo

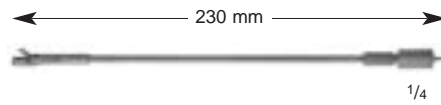

Aufsatz mit Rohr
Tip with tube
Punta con tubo
Tige avec embout
Punta con asta



Griff
Handle
Mango
Manche
Manico

| | | | |
|---|---|----------------|----------------|
|  1/1 | TOWNSEND 95-0680 gerade straight recta droit retta | 95-0681 | 95-0699 |
|  1/1 | TOWNSEND 95-0682 aufwärts gewinkelt angled upward angulada hacia arriba angulé au dessus angolata superiormente | 95-0683 | 95-0699 |
|  1/1 | TOWNSEND 95-0684 abwärts gewinkelt angled downward angulada hacia abajo angulé en dessous angolata inferiormente | 95-0685 | 95-0699 |
|  1/1 | TISCHLER 95-0686 gerade straight recta droit retta | 95-0687 | 95-0699 |
|  1/1 | TISCHLER 95-0688 aufwärts gewinkelt angled upward angulada hacia arriba angulé au dessus angolata superiormente | 95-0689 | 95-0699 |
|  1/1 | TISCHLER 95-0690 abwärts gewinkelt angled downward angulada hacia abajo angulé en dessous angolata inferiormente | 95-0691 | 95-0699 |
|  1/1 | KEVOURKIAN- YOUNGE 95-0692 gerade straight recta droit retta | 95-0693 | 95-0699 |



Uteruslöffel

Uterine Scoops
Cucharillas uterinas
Curettes utérines
Curette uterine

Uteruskürette

Uterine Curette
Cureta uterina
Curette utérine
Curette uterine



1

95-0850
6,8 mm



2

95-0851
8,5 mm

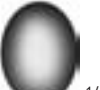

3

▶ **95-0852**
10,0 mm



4

95-0853
11,5 mm



5

95-0854
13,0 mm



6

95-0855
14,5 mm



SIMON
95-0850
- **95-0855**
25 cm, 10"

Uteruslöffel, scharf / fest
Uterine scoops, sharp / rigid
Cucharillas uterinas, cortante / rígidas
Curettes utérines, tranchantes / rigides
Curette uterine, acute / rigide



1

95-0860
6,8 mm



2

95-0861
8,5 mm



3

▶ **95-0862**
10,0 mm



4

95-0863
11,5 mm



5

95-0864
13,0 mm



6

95-0865
14,5 mm



SCHRÖDER
95-0860
- **95-0865**
30 cm, 12"

Uteruslöffel, scharf / fest
Uterine scoops, sharp / rigid
Cucharillas uterinas, cortante / rígidas
Curettes utérines, tranchantes / rigides
Curette uterine, acute / rigide



95-0820
6,0 mm



95-0821
8,0 mm



▶ **95-0822**
10,0 mm



95-0823
12,0 mm



95-0824
14,0 mm



GOURDET
95-0820
- **95-0824**
28 cm, 11"

Uteruslöffel, stumpf / fest
Uterine scoops, blunt / rigid
Cucharillas uterinas, romas / rígidas
Curettes utérines, mousses / rigides
Curette uterine, smusse / rigide



stumpf
blunt
romas
mousse
smusso



BLAKE
95-0927
27,5 cm, 10³/₄"

Uteruskürette
Uterine curette
Cureta uterina
Curette utérine
Curette uterine

scharf
sharp
cortantes
tranchantes
acuto



Uterusküretten
 Uterine Curettes
 Curetas uterinas
 Curettes utérines
 Curette uterine

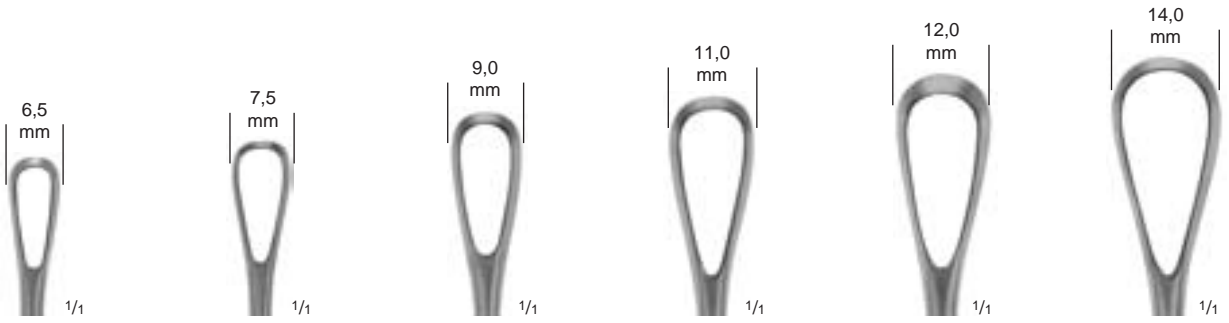

| | | | | | |
|---------|---------|---------|---------|---------|---------|
| # 1 | # 2 | # 3 | # 4 | # 5 | # 6 |
| 95-1061 | 95-1062 | 95-1063 | 95-1064 | 95-1065 | 95-1066 |
| 95-1071 | 95-1072 | 95-1073 | 95-1074 | 95-1075 | 95-1076 |
| 95-1081 | 95-1082 | 95-1083 | 95-1084 | 95-1085 | 95-1086 |
| 95-1091 | 95-1092 | 95-1093 | 95-1094 | 95-1095 | 95-1096 |



SIMS
95-1061 Fig. 1 6,5 mm
95-1062 Fig. 2 7,5 mm
95-1063 Fig. 3 9,0 mm
95-1064 Fig. 4 11,0 mm
95-1065 Fig. 5 12,0 mm
95-1066 Fig. 6 14,0 mm
 24,5 - 26,0 cm, 9³/₄" - 10¹/₄"

scharf, fest
 sharp, rigid
 cortantes, rígidas
 tranchantes, rigides
 acute, rigide

SIMS
95-1071 Fig. 1 6,5 mm
95-1072 Fig. 2 7,5 mm
95-1073 Fig. 3 9,0 mm
95-1074 Fig. 4 11,0 mm
95-1075 Fig. 5 12,0 mm
95-1076 Fig. 6 14,0 mm
 24,5 - 26,0 cm, 9³/₄" - 10¹/₄"

scharf, biegsam
 sharp, malleable
 cortantes, maleables
 tranchantes, malléables
 acute, malleabile

SIMS
95-1081 Fig. 1 6,5 mm
95-1082 Fig. 2 7,5 mm
95-1083 Fig. 3 9,0 mm
95-1084 Fig. 4 11,0 mm
95-1085 Fig. 5 12,0 mm
95-1086 Fig. 6 14,0 mm
 24,5 - 26,0 cm, 9³/₄" - 10¹/₄"

stumpf, fest
 blunt, rigid
 romas, rígidas
 mousses, rigides
 smusse, rigide

SIMS
95-1091 Fig. 1 6,5 mm
95-1092 Fig. 2 7,5 mm
95-1093 Fig. 3 9,0 mm
95-1094 Fig. 4 11,0 mm
95-1095 Fig. 5 12,0 mm
95-1096 Fig. 6 14,0 mm
 24,5 - 26,0 cm, 9³/₄" - 10¹/₄"

stumpf, biegsam
 blunt, malleable
 romas, maleables
 mousses, malléables
 smusse, malleabile



Uterusküretten
 Uterine Curettes
 Curetas uterinas
 Curettes utérines
 Curette uterine



1/2

RECAMIER

- 95-0988** Fig. 00 6,0 mm
 - 95-0989** Fig. 0 7,5 mm
 - 95-0990** Fig. 1 8,5 mm
 - 95-0991** Fig. 2 9,5 mm
 - ▶ **95-0992** Fig. 3 10,5 mm
 - 95-0993** Fig. 4 11,5 mm
 - 95-0994** Fig. 5 12,5 mm
 - 95-0995** Fig. 6 14,0 mm
 - 95-0996** Fig. 7 15,0 mm
 - 95-0997** Fig. 8 16,0 mm
 - 95-0998** Fig. 9 19,0 mm
 - 95-0999** Fig. 10 20,0 mm
- 29,5 - 32,5 cm, 11 3/4" - 12 3/4"

scharf, fest
 sharp, rigid
 cortantes, rígidas
 tranchantes, rigides
 acute, rigide



1/2

RECAMIER

- 95-0928** Fig. 00 6,0 mm
 - 95-0929** Fig. 0 7,5 mm
 - 95-0930** Fig. 1 8,5 mm
 - 95-0931** Fig. 2 9,5 mm
 - ▶ **95-0932** Fig. 3 10,5 mm
 - 95-0933** Fig. 4 11,5 mm
 - 95-0934** Fig. 5 12,5 mm
 - 95-0935** Fig. 6 14,0 mm
 - 95-0936** Fig. 7 15,0 mm
 - 95-0937** Fig. 8 16,0 mm
 - 95-0938** Fig. 9 19,0 mm
 - 95-0939** Fig. 10 20,0 mm
- 29,5 - 32,5 cm, 11 3/4" - 12 3/4"

scharf, biegsam
 sharp, malleable
 cortantes, maleables
 tranchantes, malléables
 acute, malleable



1/2

RECAMIER

- 95-0978** Fig. 00 6,0 mm
 - 95-1000** Fig. 0 7,5 mm
 - 95-1001** Fig. 1 8,5 mm
 - 95-1002** Fig. 2 9,5 mm
 - ▶ **95-1003** Fig. 3 10,5 mm
 - 95-1004** Fig. 4 11,5 mm
 - 95-1005** Fig. 5 12,5 mm
 - 95-1006** Fig. 6 14,0 mm
 - 95-1007** Fig. 7 15,0 mm
 - 95-1008** Fig. 8 16,0 mm
 - 95-1009** Fig. 9 19,0 mm
 - 95-1010** Fig. 10 20,0 mm
- 29,5 - 32,5 cm, 11 3/4" - 12 3/4"

stumpf, fest
 blunt, rigid
 romas, rígidas
 mousses, rigides
 smusse, rigide



1/2

RECAMIER

- 95-1018** Fig. 00 6,0 mm
 - 95-1020** Fig. 0 7,5 mm
 - 95-1021** Fig. 1 8,5 mm
 - 95-1022** Fig. 2 9,5 mm
 - ▶ **95-1023** Fig. 3 10,5 mm
 - 95-1024** Fig. 4 11,5 mm
 - 95-1025** Fig. 5 12,5 mm
 - 95-1026** Fig. 6 14,0 mm
 - 95-1027** Fig. 7 15,0 mm
 - 95-1028** Fig. 8 16,0 mm
 - 95-1029** Fig. 9 19,0 mm
 - 95-1030** Fig. 10 20,0 mm
- 29,5 - 32,5 cm, 11 3/4" - 12 3/4"

stumpf, biegsam
 blunt, malleable
 romas, maleables
 mousses, malléables
 smusse, malleable

Uterusküretten
 Uterine Curettes
 Curetas uterinas
 Curettes utérines
 Curette uterine



00

95-0988
 95-0928
 95-0978
 95-1018



0

95-0989
 95-0929
 95-1000
 95-1020



1

95-0990
 95-0930
 95-1001
 95-1021



2

95-0991
 95-0931
 95-1002
 95-1022



3

95-0992
 95-0932
 95-1003
 95-1023



4

95-0993
 95-0933
 95-1004
 95-1024



5

95-0994
 95-0934
 95-1005
 95-1025



6

95-0995
 95-0935
 95-1006
 95-1026



7

95-0996
 95-0936
 95-1007
 95-1027



8

95-0997
 95-0937
 95-1008
 95-1028



9

95-0998
 95-0938
 95-1009
 95-1029



10

95-0999
 95-0939
 95-1010
 95-1030



Uterusküretten
 Uterine Curettes
 Curetas uterinas
 Curettes utérines
 Curette uterine

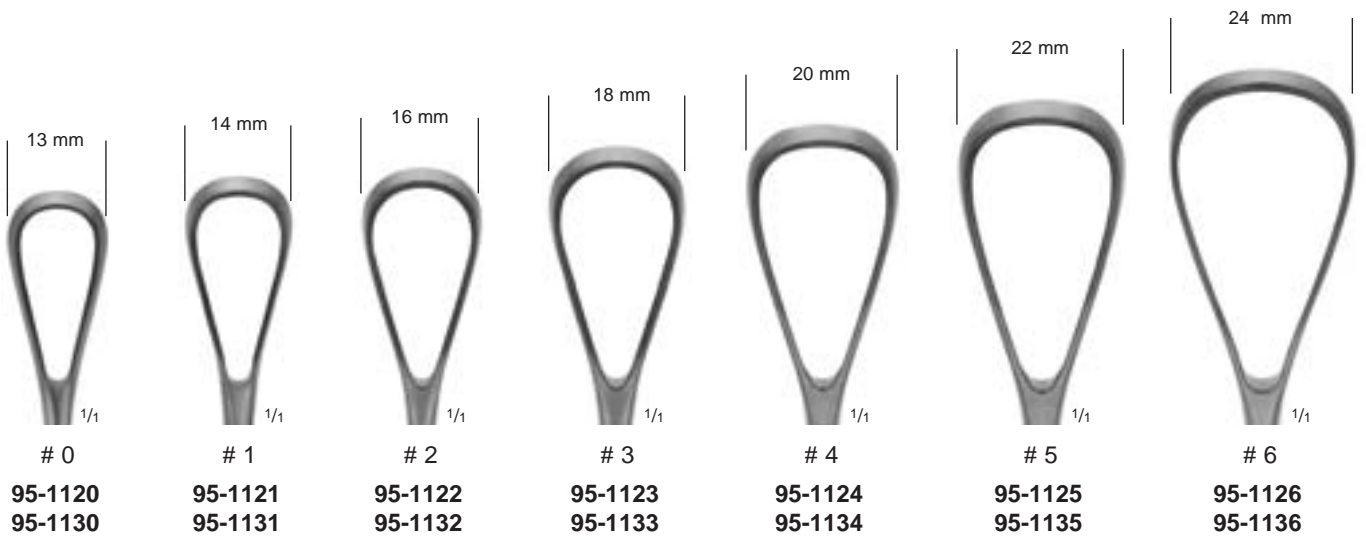

BUMM
 95-1120 Fig. 0 13 mm
 95-1121 Fig. 1 14 mm
 95-1122 Fig. 2 16 mm
 ▶ 95-1123 Fig. 3 18 mm
 95-1124 Fig. 4 20 mm
 95-1125 Fig. 5 22 mm
 95-1126 Fig. 6 24 mm
 28 - 29 cm, 11" - 11 1/2"
 scharf, biegsam
 sharp, malleable
 cortantes, maleables
 tranchantes, malléables
 acute malleable



BUMM
 95-1130 Fig. 0 13 mm
 95-1131 Fig. 1 14 mm
 95-1132 Fig. 2 16 mm
 ▶ 95-1133 Fig. 3 18 mm
 95-1134 Fig. 4 20 mm
 95-1135 Fig. 5 22 mm
 95-1136 Fig. 6 24 mm
 28 - 29 cm, 11" - 11 1/2"
 stumpf, biegsam
 blunt, malleable
 romas, maleables
 mousses, malléables
 smusse, malleable

Absaugküretten

Aspirating Curettes

Curettes de aspiración

Curettes d'aspiration

Curette per aspirazione



∅
3 mm



1/1

∅
4,5 mm



1/1

∅
6 mm



1/1

∅
8 mm



1/1

∅
10 mm



1/1

∅
12 mm



1/1

∅
14 mm



1/1



1/2

95-1150

28,5 cm

11 1/4"



1/2

95-1151

28,5 cm

11 1/4"

Probe- und Absaugküretten

Specimen and aspirating curettes
Curettes de biopsia y de aspiración
Curettes à biopsie et d'aspiration
Curette per prelievo ed aspirazione



1/2

95-1152

28,5 cm

11 1/4"



1/2

95-1153

28,5 cm

11 1/4"



1/2

95-1154

28,5 cm

11 1/4"



1/2

95-1155

28,5 cm

11 1/4"



1/2

95-1156

28,5 cm

11 1/4"

Absaugküretten

Aspirating curettes
Curettes de aspiración
Curettes d'aspiration
Curette per aspirazione

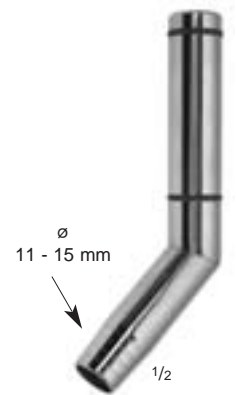

∅
11 - 15 mm

1/2

95-1159

Schlauchverbindungsstück für
Absaugküretten 95-1152 bis
95-1156, für Saugschlauch
von 11 mm Innen-∅

Coupling piece for the connection of
aspirating curettes 95-1152 - 95-1156
to flexible tube having an interior
diameter of 11 mm

Adaptador de tubo para curetas
de aspiración 95-1152 - 95-1156,
para tubos de aspiración, ∅
interior de 11 mm

Embout adaptable aux curettes
95-1152 - 95-1156 pour tube
d'aspiration, ∅ inférieur à 11 mm

Adattatore per la connessione delle
curette per aspirazione 95-1152 -
95-1156 ad un tubo flessibile avente
un ∅ int. di 11 mm



Instrumentarium zur Amnioskopie und Mikro-Blutentnahme

Instruments for Amnioscopy and Mikro-Bloodletting

Instrumental para la amnioskopía y la micro-extracción de sangre

Instrumentation pour amnioscopie

Strumentario per l'amnioscopia e il salasso



SALING

► **97-0600** ø 12-24 mm x 200 mm

97-0601 ø 16-24 mm x 200 mm

97-0602 ø 20-24 mm x 200 mm

Amnioskop-Tuben, konisch, mit Obturator

Amnioscopic tubes, cone shaped, with obturator

Amnioscopio, cónico, con obturador

Amnioscope conique, avec obturateur

Amnioscopio conico con otturatore



SALING

► **97-0620** ø 16-42 mm x 200 mm

97-0621 ø 20-44 mm x 200 mm

97-0622 ø 33-44 mm x 140 mm

Amnioskop-Tuben für die Mikro-Blutentnahme, konisch, mit Obturator

Amnioscopic tubes for micro-bloodletting, cone shaped, with obturator

Amnioscopio para la micro-extracción de sangre, cónico, con obturador

Amnioscope pour micro extraction conique, avec obturateur

Amnioscopio per salasso, conico, con otturatore



97-0641

Kaltlicht-Proximalbeleuchtung für Amnioskop-Tuben, mit Anschluß für ACM-, BRITISH STANDARD-, LAWTON-, WOLF-, HSW-, STORZ-, WINTER-, OLYMPUS-Lichtkabel

Cold-light proximal illumination for amnioscopic tubes, with connection for ACM-, BRITISH STANDARD-, LAWTON-, WOLF-, HSW-, STORZ-, WINTER-, OLYMPUS-light cable

Illuminación-proximal con luz fría para amnioscopios, con conexiones para cables conductores de luz fría ACM, BRITISH-STANDARD, LAWTON, WOLF, HSW, STORZ, WINTER y OLYMPUS

Eclairage à lumière froide pour amnioscopes, avec embouts adaptateurs pour conducteur de lumière froide ACM, BRITISH-STANDARD, LAWTON, WOLF, HSW, STORZ, WINTER et OLYMPUS

Illuminatore prossimale per amnioscopio a luce fredda con connettore per ACM, BRITISH-STANDARD, LAWTON, WOLF, HSW, STORZ, WINTER e OLYMPUS



97-0645

Warmlicht-Proximalbeleuchtung mit Lampe, 4 Volt, für Amnioskop-Tuben

Warm-light proximal illumination with lamp 4 volt for amnioscopic tubes

Illuminación-proximal con luz caliente para amnioscopios con bombilla, 4 voltios

Eclairage traditionnel avec lampes 4 volts pour tube amnioscope

Illuminatore prossimale a luce calda per amnioscopio con lampada da 4 v.



97-0646

Ersatzlampe, 4 Volt, für 95-0645

Spare lamp, 4 volt, for 95-0645

Bombilla de repuesto, 4 voltios, para 95-0645

Lampe de rechange, 4 volts, pour 95-0645

Lampada di ricambio, 4 v., per 95-0645



97-0648

Transformator, 0-5 Volt regelbar, 220 Volt (andere Spannungen auf Anfrage)

Transformer, 0-5 volt adjustable, 220 volt, (other voltage on request)

Transformador, regulable de 0-5 voltios, 220 voltios (posible en otros voltios - según demanda)

Transformateur, réglable de 0 à 5 volts, 220 volts (possibilité d'autres voltages sur demande)

Trasformatore, regolabile da 0-5 v., 220 v. (altri voltaggi a richiesta)



97-0670

Mikro-Klingen zur Blutentnahme, Packung zu 20 Stück

Micro-blades for bloodletting, package of 20 pieces

Hoja de micro-bisturí para la extracción de sangre, paquete de 20 piezas

Micro lames, paquet de 20 pièces

Micro lame per salasso, conf. da 20 pz.



1/1

97-0672

Halter für Mikro-Klingen 95-0670, Arbeitslänge 28 cm

Carrier for micro blades, working length 28 cm

Porta-hoja de micro-bisturí 95-0670, longitud de trabajo 28 cm

Porte lames 95-0670, longueur utile 28 cm

Porta micro lame, lunghezza di lavoro 28 cm



1/3

97-0674

Glaspipette zur Mikro-Blutentnahme, heparinisiert, 37 cm lang, Packung zu 5 Stück

Glass pipette for micro-bloodletting heparinized, 37 cm long, package of 5 pieces

Pipeta de vidrio para la extracción de sangre, 37 cm, paquete de 5 piezas

Pipette en verre, 37 cm, paquet de 5 pièces

Pipetta di vetro eparinizzata per micro salasso, lungh. 37 cm conf. da 5 pz.

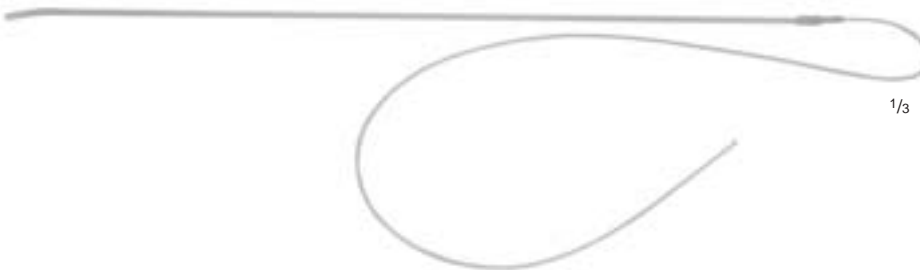

1/3

97-0676

PVC-Schlauch zum Anschluß an Glaspipette bei Mikro-Blutentnahme, 10 m lang

PVC-tubing for connection to the glass pipette during micro-bloodletting, 10 m long

Tubo de plástico con conexión para adaptar la pipeta de vidrio durante la micro-extracción de sangre, longitud 10 m

Tube plastique avec embout adaptable aux pipettes de verre pendant la micro extraction

Tubo in PVC per il collegamento alla pipetta di vetro durante il micro salasso, lungh. 10 m



1/3

97-0678

Katheter- und Schlauch-Führungszange, mit Federgriff, Arbeitslänge 28 cm

Guide forceps for catheters and tubing, with spring handle, working length 28 cm

Pinza conductora para catéteres y tubos, con mango de resorte, longitud de trabajo 28 cm

Pince conductrice pour cathéters et tubes, avec manche à ressort longueur utile 28 cm

Pinza guida per cateteri e tubi, con manico a molla, lunghezza di lavoro 28 cm



1/3

97-0680

Watte- und Tupferträger, dreiteiliges Maul, Arbeitslänge 30 cm

Cotton and sponge holder, three-jawed grip, working length 30 cm

Porta-algodón y -tapones, mandibula tripartita, longitud de trabajo 30 cm

Porte coton, à trois griffes, longueur utile 30 cm

Porta spugne/cotone, presa a 3 morsi, lunghezza di lavoro 30 cm



1/3



Instrumentarium zur Hysterosalpingographie

Instrumentation for Hystero-Salpingography

Instrumental para histero-salpingografía

Instrumentation pour hystéro-salpingographie

Strumentario per isterosalpingografia



97-0666



97-0667



97-0668



97-0669



97-0664



97-0665



97-0663

SCHULTZE

97-0660

Salpingograph zur Sterilitätsdiagnose und -behandlung, zur Röntgendarstellung und Durchblasung von Cervix, Uterus und Tuben, komplett, bestehend aus:

- 97-0664 1 Druckmanometer, mit Leuchtskala
- 97-0663 1 Verbindungsstück mit Hahn
- 97-0665 1 Tubenkatheter mit Hahn
- 97-0666 1 auswechselbarer Uterusverschlußkegel, klein
- 97-0667 1 auswechselbarer Uterusverschlußkegel, mittel
- 97-0668 1 auswechselbarer Uterusverschlußkegel, groß
- 97-0669 1 Recordspritze 10 ml, mit LUER-LOCK-Ansatz
- 97-0661 1 Holzetui

Salpingograph for diagnosis and treatment of sterility, for injections of Lipiodol into the uterus and the Fallopian tubes, for intra-uterine insufflation and for diagnosis by x-rays, complete, consisting of:

- 97-0664 1 Manometer with luminous dial
- 97-0663 1 Connecting-piece with stopcock
- 97-0665 1 Uterine cannula with stopcock
- 97-0666 1 Interchangeable occlusive nozzle, small
- 97-0667 1 Interchangeable occlusive nozzle, medium
- 97-0668 1 Interchangeable occlusive nozzle, large
- 97-0669 1 Record syringe 10 ccm, with LUER-LOCK mount
- 97-0661 1 Wooden Case

Salpingógrafo completo para el diagnóstico y tratamiento de la esterilidad, para inyecciones de Lipiodol en el útero y en las trompas de Falopio, para la insuflación intra-uterina y para el diagnóstico radiográfico, completo, compuesto de:

- 97-0664 1 Manómetro con escala luminosa
- 97-0663 1 Pieza conectiva con llave
- 97-0665 1 Sonda para trompas de Falopio con llave
- 97-0666 1 Cono uterinos intercambiables, pequeño
- 97-0667 1 Cono uterinos intercambiables, mediano
- 97-0668 1 Cono uterinos intercambiables, grande
- 97-0669 1 Jeringa Record 10 ccm, con LUER-LOCK
- 97-0661 1 Estuche de madera

Salpingographe complet pour diagnostic et traitement de la stérilité, pour injection de lipiodol dans l'utérus et les trompes, pour insufflation intra utérine et diagnostic avec rayons X, complet, composé de:

- 97-0664 1 Manomètre
- 97-0663 1 Embout avec robinet
- 97-0665 1 Canule utérine avec robinet
- 97-0666 1 Embout petit
- 97-0667 1 Embout moyen
- 97-0668 1 Embout grand
- 97-0669 1 Seringue 10 cc avec embout LUER-LOCK
- 97-0661 1 Boîtier en bois

Salpingografo per la diagnosi, ed il trattamento della sterilita, per l'iniezione di lipioda nell'utero e nei tubi di falloppio, per l'insufflazione introuterina e diagnostica a raggi X, completo, composto da:

- 97-0664 1 Manometro con ruadrante luminoso
- 97-0663 1 Connessione con rubinetto
- 97-0665 1 Cannula uterina con rubinetto
- 97-0666 1 Cono d'occlusione intercambiabile, piccolo
- 97-0667 1 Cono d'occlusione intercambiabile, medio
- 97-0668 1 Cono d'occlusione intercambiabile, grande
- 97-0669 1 Siringa record 10 ccm, con attacco LUER-LOCK
- 97-0661 1 Astuccio in legno

SCHULTZE

97-0662

Salpingograph - ohne Manometer - zur Sterilitätsdiagnose und -behandlung, zur Röntgendarstellung und Durchblasung von Cervix, Uterus und Tuben, komplett, bestehend aus:

- 97-0665 1 Tubenkatheter mit Hahn
- 97-0666 1 auswechselbarer Uterusverschlußkegel, klein
- 97-0667 1 auswechselbarer Uterusverschlußkegel, mittel
- 97-0668 1 auswechselbarer Uterusverschlußkegel, groß
- 97-0669 1 Recordspritze 10 ml, mit LUER-LOCK-Ansatz
- 97-0661 1 Holzetui

Salpingograph - without manometer - for diagnosis and treatment of sterility, for injections of Lipiodol into the uterus and the Fallopian tubes, for intra-uterine insufflation and for diagnosis by x-rays, complete, consisting of:

- 97-0665 1 Uterine cannula with stopcock
- 97-0666 1 Interchangeable occlusive nozzle, small
- 97-0667 1 Interchangeable occlusive nozzle, medium
- 97-0668 1 Interchangeable occlusive nozzle, large
- 97-0669 1 Record syringe 10 ccm, with LUER-LOCK mount
- 97-0661 1 Wooden Case

Salpingógrafo - sin manómetro - completo para el diagnóstico y tratamiento de la esterilidad, para inyecciones de Lipiodol en el útero y en las trompas de Falopio, para la insuflación intra-uterina y para el diagnóstico radiográfico, completo, compuesto de:

- 97-0665 1 Sonda para trompas de Falopio con llave
- 97-0666 1 Cono uterinos intercambiables, pequeño
- 97-0667 1 Cono uterinos intercambiables, mediano
- 97-0668 1 Cono uterinos intercambiables, grande
- 97-0669 1 Jeringa Record 10 ccm, con LUER-LOCK
- 97-0661 1 Estuche de madera

Salpingographe - sans manomètre - complet pour diagnostic et traitement de la stérilité, pour injection de lipiodol dans l'utérus et les trompes, pour insufflation intra utérine et diagnostic avec rayons X, complet, composé de:

- 97-0665 1 Canule utérine avec robinet
- 97-0666 1 Embout petit
- 97-0667 1 Embout moyen
- 97-0668 1 Embout grand
- 97-0669 1 Seringue 10 cc avec embout LUER-LOCK
- 97-0661 1 Boîtier en bois

Salpingografo - senza manometro - per la diagnosi, ed il trattamento della sterilita, per l'iniezione di lipioda nell'utero e nei tubi di falloppio, per l'insufflazione introuterina e diagnostica a raggi X, completo, composto da:

- 97-0665 1 Cannula uterina con rubinetto
- 97-0666 1 Cono d'occlusione intercambiabile, piccolo
- 97-0667 1 Cono d'occlusione intercambiabile, medio
- 97-0668 1 Cono d'occlusione intercambiabile, grande
- 97-0669 1 Siringa record 10 ccm, con attacco LUER-LOCK
- 97-0661 1 Astuccio in legno



LAWNTON

Medizintechnik

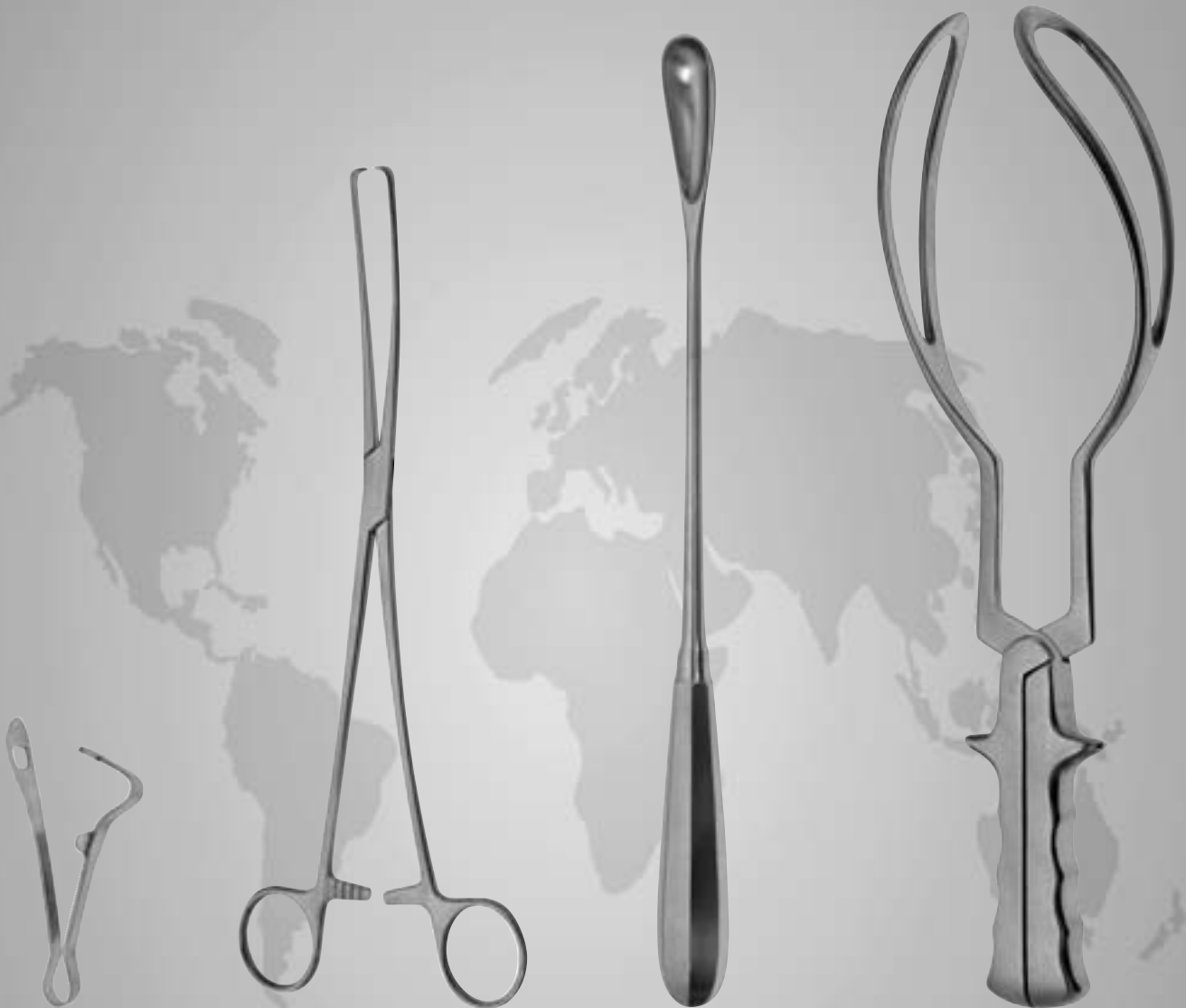

Geburtshilfe
Obstetrics
Obstetricia
Obstétrique
Ostetricia



Instrumente für Geburtshilfe
 Instruments for Obstetrics
 Instrumentos para obstétrica
 Instruments pour obstétrique
 Strumenti per ostetricia



| | | |
|---|--------|----|
| DURACUT® Damm- (Episiotomie-) Scheren | Seite | 60 |
| DURACUT® Perineum (Episiotomy) Scissors | Page | 60 |
| DURACUT® Tijeras para perineo (episiotomía) | Página | 60 |
| DURACUT® Ciseaux à périnée (à épisiotomie) | Page | 60 |
| DURACUT® Forbici per perineo (episiotomia) | Pagina | 60 |



| | | |
|--|--------|-----|
| Damm- (Episiotomie-) Scheren | Seite | 107 |
| Perineum (Episiotomy) Scissors | Page | 107 |
| Tijeras para perineo (episiotomía) | Página | 107 |
| Ciseaux à périnée (à épisiotomie) | Page | 107 |
| Forbici per perineo (episiotomia) | Pagina | 107 |



| | | |
|--|--------|-----|
| Nabelschnurscheren | Seite | 108 |
| Umbilical Cord Scissors | Page | 108 |
| Tijeras umbilicales | Página | 108 |
| Ciseaux pour le cordon ombilical | Page | 108 |
| Forbici ombelicali | Pagina | 108 |



| | | |
|---------------------------------|--------|-----|
| Kephalotomiescheren | Seite | 109 |
| Decapitating Scissors | Page | 109 |
| Tijeras para decapitación | Página | 109 |
| Ciseaux à détroncation | Page | 109 |
| Forbici per decapitazione | Pagina | 109 |

Beckenzirkel
Pelvimeter
Pelvímetro
Pelvimètre
Pelvimetro

Amniotom
Amniotome
Amniótomo
Amniotome
Amniotomo

Blasensprenger
Membrane Puncturing Forceps
Pinza para la vejiga amniótica
Pince perce membrane
Pinza per la puntura amniotica



MARTIN
97-0100
35 cm, 13³/₄"

Beckenzirkel, mit Zentimeter- und Zolleinteilung
Pelvimeter, graduated in centimeters and inches
Pelvímetro, graduado en centímetros y pulgadas
Pelvimètre, gradué en cm et en pouces
Pelvimetro, graduato in cm e in pollice



BEACHAM
97-0493
26,5 cm, 10¹/₂"

Amniotom für die Amnionblase
Amniotome for the amnion bladder
Amniótomo para la vejiga amniótica
Amniotome pour le liquide amniotique
Amniotomo per la vescica amniotica

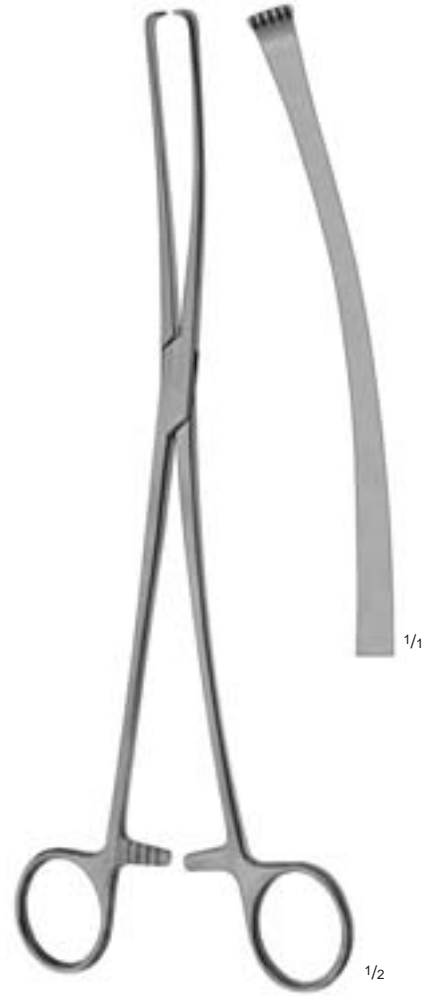

IOWA
97-0495
26 cm, 10¹/₄"

Blasensprenger, 5x6 Zähne
Membrane puncturing forceps, 5x6 teeth
Pinza para la vejiga amniótica 5x6 dientes
Pince perce membrane, 5x6 dents
Pinza per puntura amniotica, 5x6 denti



Geburtszangen

Forceps

Fórceps

Forceps

Forcipi



SIMPSON-BRAUN
97-0201
31 cm, 12¹/₄"



SIMPSON-BRAUN
97-0200
36 cm, 14¹/₄"



NAEGELE
97-0202
35,5 cm, 14"



NAEGELE
97-0203
40 cm, 15³/₄"



KIELAND
97-0220
41 cm, 16"

1/3



KIELAND-LUIKART
97-0225
41 cm, 16"

1/3

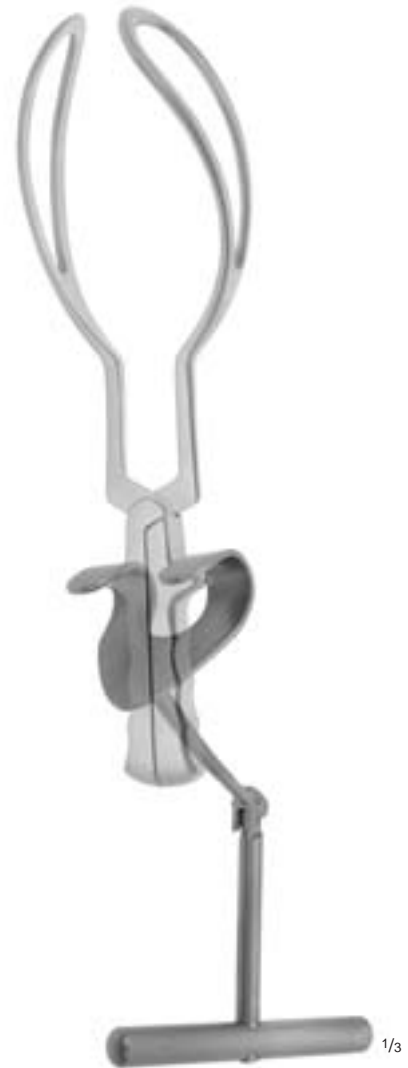

BILL
97-0290

Zughebel, passend für alle Geburtszangen mit
gehorntem Standard-Griff

Traction handle to be used with all forceps with
standard type handle

Tractor adecuado para todas las fórceps con mango
standard

Tracteurs pour tous les forceps avec manches
ordinaires

Manico a trazione adatto a tutte le forcipi con manico
standard

1/3



Geburtszangen

Forceps

Fórceps

Forceps

Forcipi



1/3

WRIGLEY
97-0192
28 cm, 11"

Geburtszange für section caesares (Schnittentbindung)

Forceps for caesarean section

Fórceps para operación cesárea

Forceps pour césarienne

Forcipi per tagli cesarei



1/3

PIPER
97-0300
44,5 cm, 17 1/2"

für nachkommenden Kopf bei Steisslagen

for delivery of the after coming head in breech presentation

especialmente para partos en presentación de nalgas

Spatules pour dégager la tête

Speciale in parti con prententazione di podice



1/3

TARNIER
97-0306
40 cm, 15 3/4"

Geburtszange mit Achsenzugvorrichtung

Forceps with traction rod

Fórceps con dispositivo de tracción

Forceps avec dispositif de traction

Forcipi con dispositivo di trazione



1/2

SELLHEIM
 97-0382
 32 cm, 12 1/2"

Geburtslöffel
 Obstetric lever
 Separador para la salida de cabeza
 Levier obstétrique
 Leva ostetrica



1/3

MURLESS
 97-0380
 30 cm, 12"

Kopfhebel für unteres Segment bei Kaiserschnitt
 Head extractor for use in lower segment in caesarean operation
 Elevador para cabeza usándose en le segmento inferior del útero
 en casos de operaciones cesáreas
 Levier à tête utilisé en cas de césarienne
 Elevatore per testa in interventi con taglio cesareo

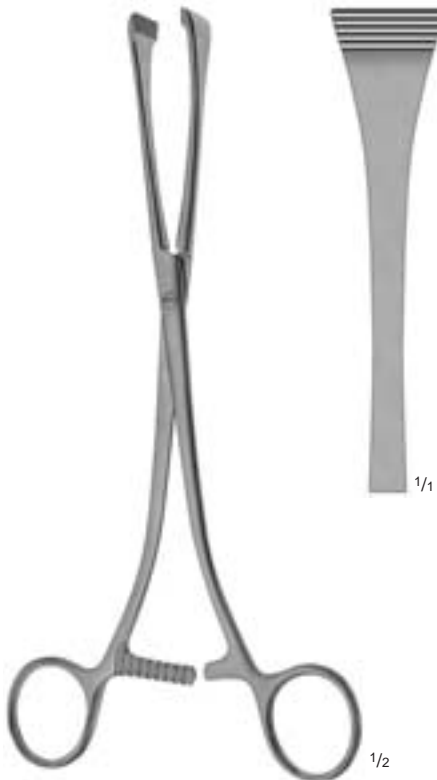

1/1

1/2

GREEN-ARMYTAGE
 97-0390
 20,5 cm, 8"

Uterusklemmzange zur Blutstillung
 Caesarean section haemostatic forceps
 Pinza-clamp uterina para hemostasis
 Pince-clamp utérine pour hémostase
 Pinza emostatiche per tagli cesarei



1/1

1/2

WILLETT
 97-0490
 19 cm, 7 1/2"

Kopfschwartzange
 Scalp flap forceps
 Pinza para pericráneo
 Pince pour le cuir chevelu
 Pinza per il cuoio cappelluto



Plazentar- und Abortuszangen
Placenta and Ovum Forceps
Pinzas para aborto y placenta
Pinces placentaires et pour poste-abortum
Pinze placenta e per ovaie



97-0370
28,5 cm, 11 1/4"



▶ 97-0371
28,5 cm, 11 1/4"



97-0372
28,5 cm, 11 1/4"



97-0373
28,5 cm, 11 1/4"



▶ 97-0374
28,5 cm, 11 1/4"



97-0375
28,5 cm, 11 1/4"

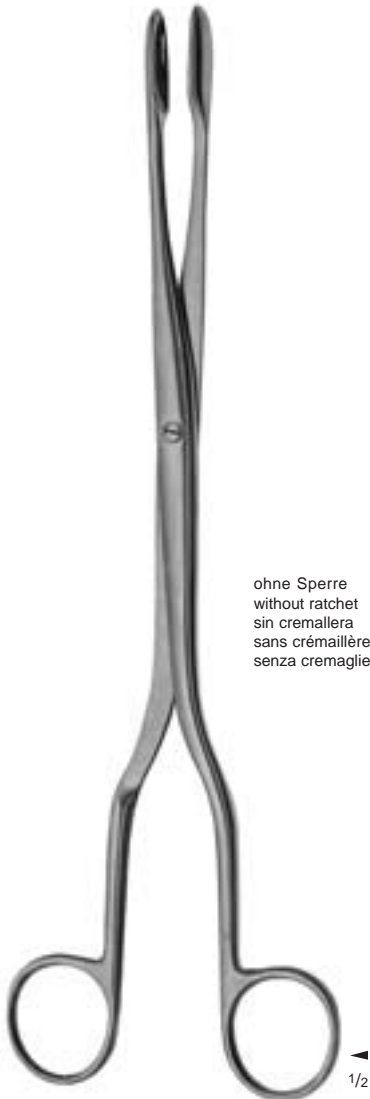

ohne Sperre
without ratchet
sin cremallera
sans crémaillère
senza cremagliera

WINTER
97-0370
- 97-0372



ohne Sperre
without ratchet
sin cremallera
sans crémaillère
senza cremagliera

WINTER
97-0373
- 97-0375



ohne Sperre
 without ratchet
 sin cremallera
 sans crémaillère
 senza cremagliera

SAENGER
 97-0470
 29 cm, 11 1/2"



mit Sperre
 with ratchet
 con cremallera
 avec crémaillère
 con cremagliera

SAENGER
 97-0471
 27,5 cm, 10 3/4"

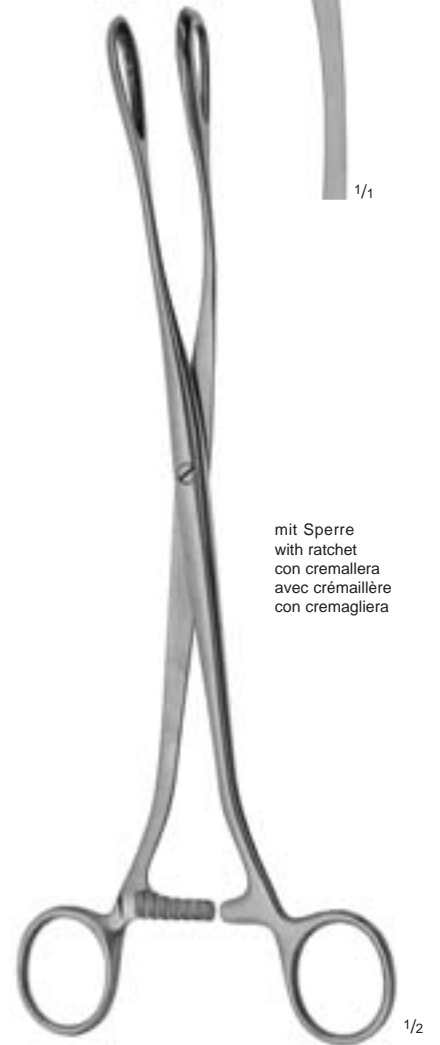

mit Sperre
 with ratchet
 con cremallera
 avec crémaillère
 con cremagliera

SAENGER
 97-0472
 27,5 cm, 10 3/4"



Plazentar- und Abortuslöffel
Placenta and Ovum Scoops
Cucharillas para aborto y placenta
Curettes à avortement et placenta
Cucchiai per placenta e ovaie

Plazentar- und Abortusküretten
Placenta and Ovum Curettes
Curetas para aborto y placenta
Curettes à avortement et placenta
Curette per placenta e ovaie

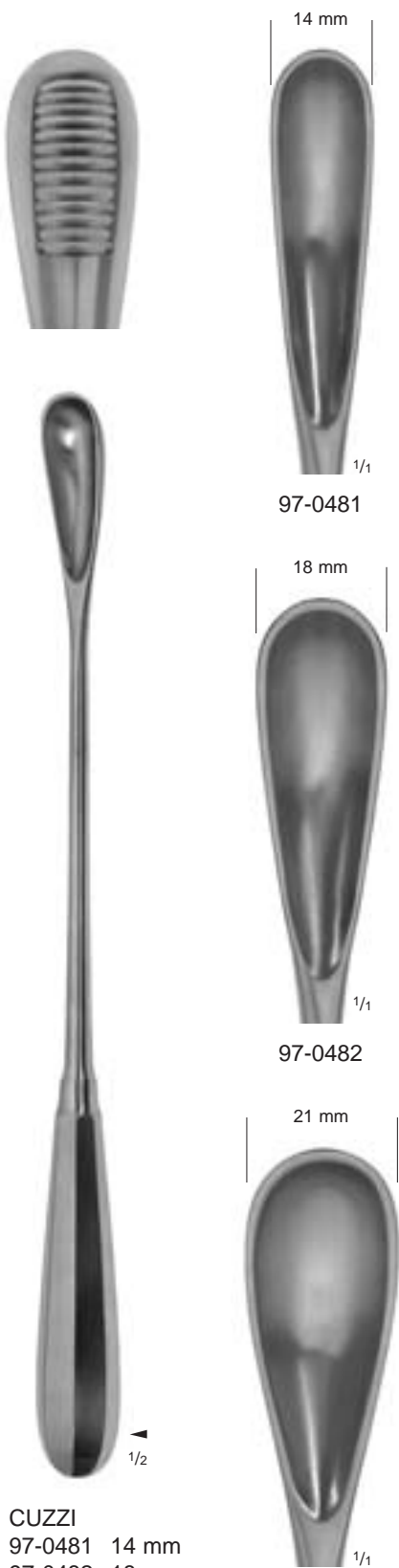

CUZZI

- 97-0481 14 mm
- ▶ 97-0482 18 mm
- 97-0483 21 mm
- 30 cm, 12"

Plazentar- und Abortuslöffel
Placenta and ovum scoops
Cucharillas para aborto y placenta
Curettes à avortement et placenta
Cucchiai per placenta e ovaie

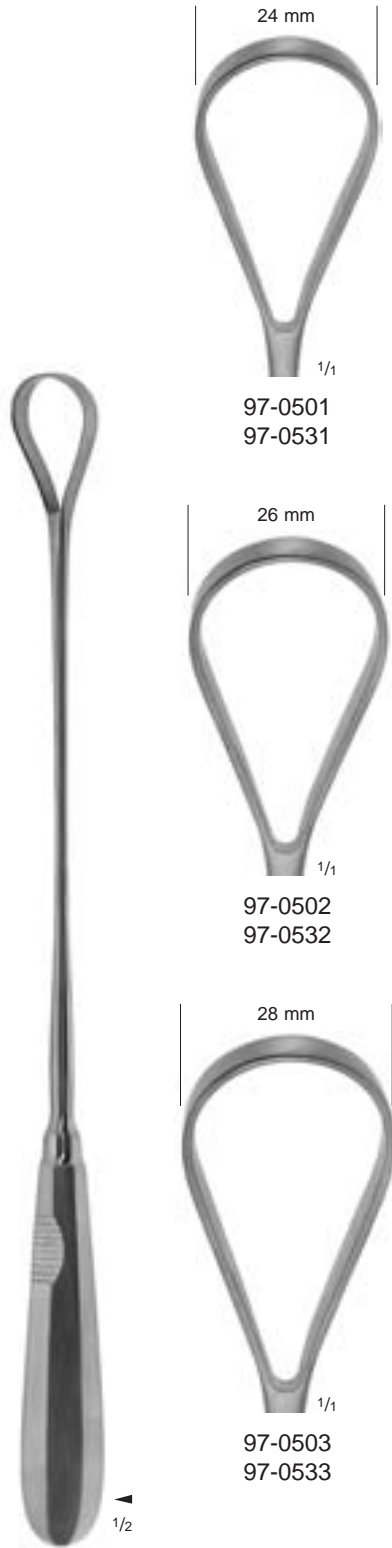

BUMM

- ▶ 97-0501 24 mm
- 97-0502 26 mm
- 97-0503 28 mm
- 31 cm, 12 1/4"
- 97-0531 24 mm
- 97-0532 26 mm
- 97-0533 28 mm
- 31 cm, 12 1/4"

scharf, biegsam
sharp, malleable
cortantes, maleable
trachentes, malléables
acute, malleabile

stumpf, biegsam
blunt, malleable
romas, maleable
mousses, malléables
smusse, malleabile

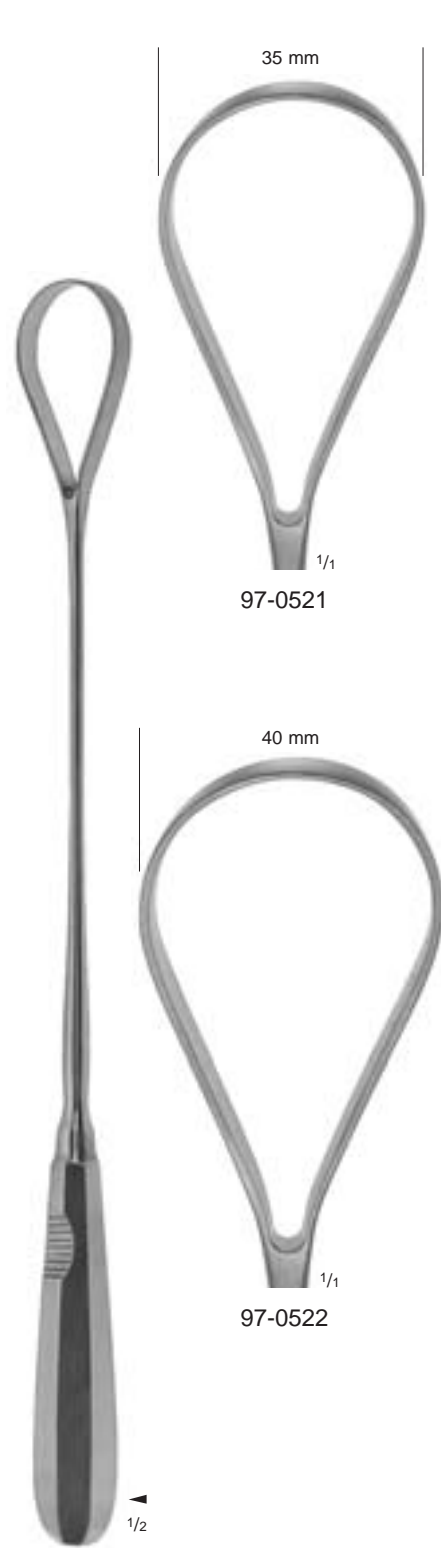

RECAMIER

- 97-0521 35 mm
- ▶ 97-0522 40 mm
- 33,5 cm, 13 1/4"

Plazentar- und Abortusküretten, stumpf / fest
Placenta and ovum curettes, blunt / rigid
Curetas para aborto y placenta, romas / rígidas
Curettes à avortement et placenta, mousse / rigide
Curette per placenta e ovaie, smusse / rigide

Kranioklast
Cranioclast
Craneoclasto
Cranioclaste
Cranioclasto

Perforatorium
Perforator
Perfora-crâneos
Perce-crâne
Spezzacrano

Dekapitationshaken
Decapitating Hook
Gancho para decapitación
Crochet pour décapitation
Uncino per detroncazione



BRAUN
97-0410
42 cm, 16 1/2"

Kranioklast
Cranioclast
Craneoclasto
Cranioclaste
Cranioclasto



SMELLIE
97-0430
25,5 cm, 10"

Perforatorium
Perforator
Perfora-crâneos
Perce-crâne
Spezzacrano



BRAUN
97-0415
32,5 cm, 12 3/4"

Dekapitationshaken
Decapitating hook
Gancho para decapitación
Crochet pour décapitation
Uncino per detroncazione



Instrumente zur Geburtshilfe
Instruments for Obstetrics
Instrumentos para obstétrica
Instruments pour obstétrique
Strumenti per ostetricia

Instrumente zur transvaginalen Injektion bei Paracervical- und Pudendusnästhesie

Instruments for transvaginal injection for paracervical anaesthesia as well as anaesthesia of the pudendus

Instrumentos para la anestesia transvaginal (pudendus)

Instruments pour anesthésie vaginale

Strumenti per anestesia paracervicale o del pudendo mediante iniezione transvaginale



IOWA
97-0440
14 cm, 5 1/2"

Nadelführung
Trumpet needle guide
Aguja de guía
Aiguille trompette guide
Guida ago a tromba



IOWA
97-0443
ø 0,9 mm x 150 mm

Injektionskanüle,
LUER-LOCK
Injection needle,
LUER-LOCK

Aguja hipodérmica,
LUER-LOCK

Aiguille à hypodermique
LUER-LOCK

Ago per iniezione, attacco
LUER-LOCK



HASSELTINE
97-0515
6 cm, 2 3/8"

Nabelschnurklemmen, in
Packungen zu 12 Stück

Umbilical cord clamps, in
packages of 12 pieces

Clamps umbilicales, en
paquetes de 12 piezas

Clamps pour le cordon
ombilical, en paquet de 12

Pinze ombelicali, pacchi
da 12 pz.



COLLIN
97-0513
9 cm, 3 1/2"

Nabelschnurklemme
Umbilical cord clamp
Clamp umbilicale
Clamp pour le cordon ombilical
Clamp ombelicale



LAWNTON
Medizintechnik



Thorax- und Gefäßchirurgie
Thoracic and Vascular Surgery
Cirugía torácico y vascular
Chirurgie thoracique et vasculaire
Chirurgia toracica e vascolare



Instrumente für Thorax- und Gefäßchirurgie
 Instruments for Thoracic and Vascular Surgery
 Instrumentos para cirugía torácico y vascular
 Instruments pour chirurgie thoracique et vasculaire
 Strumenti per la chirurgia vascolare e toracica



| | | |
|------------------------------------|--------|---------|
| DURACUT® Gefäßscheren | Seite | 56 - 57 |
| DURACUT® Vascular Scissors | Page | 56 - 57 |
| DURACUT® Tijeras vasculares | Página | 56 - 57 |
| DURACUT® Ciseaux vasculaires | Page | 56 - 57 |
| DURACUT® Forbici vascolari | Pagina | 56 - 57 |



| | | |
|---|--------|----|
| Gefäßscheren mit flachen Federgriffen | Seite | 64 |
| Vascular Scissors with Flat Spring Type Handles | Page | 64 |
| Tijeras vasculares con mangos de resortes planos | Página | 64 |
| Ciseaux vasculaires avec manches à ressorts plats | Page | 64 |
| Forbici vascolari con manici a molla piatta | Pagina | 64 |



| | | |
|---------------------------|--------|---------|
| Gefäßscheren | Seite | 95 - 99 |
| Vascular Scissors | Page | 95 - 99 |
| Tijeras vasculares | Página | 95 - 99 |
| Ciseaux vasculaires | Page | 95 - 99 |
| Forbici vascolari | Pagina | 95 - 99 |



| | | |
|------------------------------|--------|----|
| Lungenlappenschere | Seite | 99 |
| Lobectomy Scissors | Page | 99 |
| Tijera para lobectomía | Página | 99 |
| Ciseaux à lobectomie | Page | 99 |
| Forbici per lobectomia | Pagina | 99 |



| | | |
|--|--------|-----|
| ATRAUMATIC-GRIP Gefäßpinzetten | Seite | 135 |
| ATRAUMATIC-GRIP Vascular Forceps | Page | 135 |
| ATRAUMATIC-GRIP Pinzas vasculares | Página | 135 |
| ATRAUMATIC-GRIP Pincas vasculaires | Page | 135 |
| ATRAUMATIC-GRIP Pinze vascolari | Pagina | 135 |



| | | |
|--|--------|-----------|
| Lungenfaßpinzetten | Seite | 148 - 149 |
| Lung Grasping Forceps..... | Page | 148 - 149 |
| Pinzas agarre del pulmón | Página | 148 - 149 |
| Pince pour dissection des poumons | Page | 148 - 149 |
| Pinze da presa per la dissezione del polmone | Pagina | 148 - 149 |



| | | |
|---|--------|-----------|
| TITAN-LINE Bulldogklemmen aus TITAN | Seite | 160 - 161 |
| TITAN-LINE Bulldog Clamps, made of TITANIUM | Page | 160 - 161 |
| TITAN-LINE Clamps Bulldog, de TITANIO | Página | 160 - 161 |
| TITAN-LINE Clamps Bulldog en TITANE | Page | 160 - 161 |
| TITAN-LINE Pinze Bulldog in TITANIO | Pagina | 160 - 161 |



| | | |
|----------------------------|--------|-----|
| Mikro-Bulldogklemmen | Seite | 162 |
| Micro Bulldog Clamps | Page | 162 |
| Micro-Clamps Bulldog | Página | 162 |
| Micro Clamps Bulldog | Page | 162 |
| Micro Pinze Bulldog | Pagina | 162 |



| | | |
|----------------------|--------|-----|
| Bulldogklemmen | Seite | 163 |
| Bulldog Clamps | Page | 163 |
| Clamps Bulldog | Página | 163 |
| Clamps Bulldog | Page | 163 |
| Pinze Bulldog | Pagina | 163 |



| | | |
|---|--------|---------------|
| ATRAUMATIC-GRIP Gefäßklemmen | Seite | 165, 167, 176 |
| ATRAUMATIC-GRIP Vascular Clamps | Page | 165, 167, 176 |
| ATRAUMATIC-GRIP Pinzas-clamps vasculares | Página | 165, 167, 176 |
| ATRAUMATIC-GRIP Pincas-clamps vasculaires | Page | 165, 167, 176 |
| ATRAUMATIC-GRIP Pinze/clamp cardiovascolari | Pagina | 165, 167, 176 |

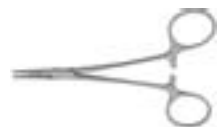

| | | |
|---|--------|-----------|
| Präparier- und Ligaturklemmen | Seite | 180 - 189 |
| Dissecting and Ligature Forceps | Page | 180 - 189 |
| Pinzas de disección y ligaduras | Página | 180 - 189 |
| Pincas à disséquer et à ligatures | Page | 180 - 189 |
| Pinze per dissezione e legature | Pagina | 180 - 189 |



| | | |
|---|--------|-----|
| ATRAUMATIC-GRIP Präparier- und Ligaturklemmen | Seite | 186 |
| ATRAUMATIC-GRIP Dissecting and Ligature Forceps | Page | 186 |
| ATRAUMATIC-GRIP Pinzas de disección y ligaduras | Página | 186 |
| ATRAUMATIC-GRIP Pincas à disséquer et à ligatures | Page | 186 |
| ATRAUMATIC-GRIP Pinze per dissezione e legature | Pagina | 186 |





Instrumente für Thorax- und Gefäßchirurgie
 Instruments for Thoracic and Vascular Surgery
 Instrumentos para cirugía torácico y vascular
 Instruments pour chirurgie thoracique et vasculaire
 Strumenti per la chirurgia vascolare e toracica



| | | |
|--------------------------------|--------|-----|
| Scapula-Haken | Seite | 260 |
| Scapula Retractors | Page | 260 |
| Separadores para scápula | Página | 260 |
| Ecarteurs à scapula..... | Page | 260 |
| Retrattori per scapola | Pagina | 260 |



| | | |
|----------------------------------|--------|-----|
| Lungenhaken | Seite | 260 |
| Lung Retractors | Page | 260 |
| Separadores para el pulmón | Página | 260 |
| Ecarteur à poumons | Page | 260 |
| Retrattori per polmone | Pagina | 260 |



| | | |
|--|--------|-----------|
| Wundhaken und Lungenspatel | Seite | 260 - 265 |
| Retractors and Lung Spatulas | Page | 260 - 265 |
| Separadores y espátulas para el pulmón | Página | 260 - 265 |
| Ecarteurs et spatules pulmonaires | Page | 260 - 265 |
| Retrattori e spatole per polmone | Pagina | 260 - 265 |



| | | |
|---------------------------|--------|-----|
| Venenstripper | Seite | 315 |
| Vein Strippers | Page | 315 |
| Sondas para várices | Página | 315 |
| Strippers à varices | Page | 315 |
| Sonde per vene | Pagina | 315 |



| | | |
|---|--------|-----|
| Gefäßspülkanülen | Seite | 322 |
| Vascular Irrigation Cannulae | Page | 322 |
| Cánulas vasculares para irrigación | Página | 322 |
| Aiguilles vasculaires pour irrigation | Page | 322 |
| Cannule vascolari per irrigazione | Pagina | 322 |



| | | |
|-----------------------------|--------|-----------|
| Saugrohre | Seite | 325 - 327 |
| Suction Tubes | Page | 325 - 327 |
| Tubos para aspiración | Página | 325 - 327 |
| Canules d'aspiration | Page | 325 - 327 |
| Tubi per aspirazione | Pagina | 325 - 327 |

Instrumente für Thorax- und Gefäßchirurgie
 Instruments for Thoracic and Vascular Surgery
 Instrumentos para cirugía torácico y vascular
 Instruments pour chirurgie thoracique et vasculaire
 Strumenti per la chirurgia vascolare e toracica



| | | |
|--|--------|-----------|
| Lungenfaßzangen | Seite | 385 - 388 |
| Lung Grasping Forceps..... | Page | 385 - 388 |
| Pinzas-clamps agarre del pulmón | Página | 385 - 388 |
| Pinces-clamps pour poumons | Page | 385 - 388 |
| Pinze da presa per la dissezione del polmone | Pagina | 385 - 388 |



| | | |
|--|--------|-----|
| ATRAUMATIC-GRIP Gewebe- und Organfaßzangen | Seite | 389 |
| ATRAUMATIC-GRIP Tissue and Organ Grasping Forceps | Page | 389 |
| ATRAUMATIC-GRIP Pinzas para tejidos y organos | Página | 389 |
| ATRAUMATIC-GRIP Pinces pour tissn et organes | Page | 389 |
| ATRAUMATIC-GRIP Pinze da presa per tessuti ed organi | Pagina | 389 |



| | | |
|---------------------------------|--------|-----|
| Embolusfaßzangen | Seite | 418 |
| Embolus Grasping Forceps | Page | 418 |
| Pinza agarre para embolus | Página | 418 |
| Pinces à traction | Page | 418 |
| Pinze da presa per emboli | Pagina | 418 |





Sternummeißel
 Sternum Chisel
 Cincel para esternón
 Cisaille et ciseau-burins à sternum
 Scalpello per sterno

Rippenscheren
 Rib Shears
 Costótomos
 Costotomes
 Costotomi



LEBSCHER
 38-0255
 25,5 cm, 10"

Sternummeißel
 Sternum chisel
 Cincel para esternón
 Cisaille et ciseau-burins à sternum
 Scalpello per sterno



GLUCK
 38-0110
 21 cm, 8 1/4"

Rippenscherer mit ziehendem Schnitt
 Rib shears with drawing cut
 Costótomo con hoja de retroacción
 Costotome avec lame excentrée
 Costotomo con lama eccentrica a scorrimento



38-0099
 22 cm, 8 3/4"

Rippenscherer
 Rib shears
 Costótomo
 Costotome
 Costotomo



38-0100
 23 cm, 9"

Rippenscherer
 Rib shears
 Costótomo
 Costotome
 Costotomo



SAUERBRUCH
 38-0150
 27 cm, 10 3/4"

Rippenscherer
 Rib shears
 Costótomo
 Costotome
 Costotomo



STILLE-GIERTZ
 38-0200
 27 cm, 10 3/4"

Rippenscherer
 Rib shears
 Costótomo
 Costotome
 Costotomo

Rippenscheren
Rib Shears
Costótomos
Costotomes
Costotomi

Rippen- und Knochenfaßzangen
Rib and Bone Holding Forceps
Pinzas para huesos
Daviers à os
Pinze per ossa e costole



BETHUNE
38-0330
34,5 cm, 13 1/2"

Rippenschere
Rib shears
Costótomo
Costotome
Costotomo

1/3



für die erste Rippe
for the first rib
para la primera costilla
pour la première côte
per la prima costola

SAUERBRUCH-FREY
38-0198
34,5 cm, 13 1/2"

Rippenschere
Rib shears
Costótomo
Costotome
Costotomo

1/3



SEMB
38-0230
19,5 cm, 7 3/4"

Rippen- und Knochenfaßzange
Rib and bone holding forceps
Pinza para huesos
Daviers à os
Pinza per ossa e costole

1/2



SEMB
38-0231
19,5 cm, 7 3/4"

Rippen- und Knochenfaßzange
Rib and bone holding forceps
Pinza para huesos
Daviers à os
Pinza per ossa e costole

1/2



Knochensplitterzangen
 Bone Cutting Forceps
 Pinzas cortantes para huesos
 Pincès coupantes à os
 Cesioie per ossa

Hohlmeißelzangen
 Rib Rongeurs
 Pinzas-gubias
 Pincès-gouges
 Pinze per costole

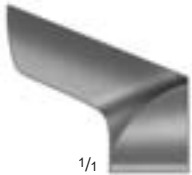

1/1

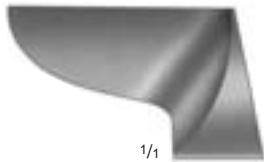

1/1



1/1



1/1



1/3



1/3



1/3



1/3

LISTON-KEY-HORSLEY
 38-0220
 24,5 cm, 9 3/4"

Knochensplitterzange, doppelt gebogen, für hintere Rippenstümpfe

Bone cutting forceps, S - shaped, for posterior rib stumps

Pinza cortante para huesos, doble curvada, para los muñones de las costillas posteriores

Pincès coupantes à os, double courbure pour extrémité des côtes postérieures

Cesioia per ossa, ad „s“ per estremità delle costole posteriori

SEMB
 38-0210
 23,5 cm, 9 1/4"

Knochensplitterzange, seitwärts gebogen, für vordere Rippenstümpfe

Bone cutting forceps, curved sideways, for anterior rib stumps

Pinza cortante para huesos, curvada lateral, para los muñones de las costillas anteriores

Pincès coupantes à os, courbure latérale pour extrémité des côtes antérieures

Cesioia per ossa, curve lateralmente per le estremità delle costole anteriori

MARKWALDER
 45-0498
 19 cm, 7 1/2"

Rundmeißelzange zum Abrunden der Rippenstümpfe

Rib rongeur to round the rib stumps

Pinza gubia redonda para redondear los muñones de las costillas

Pincès coupante pour la base des côtes

Pinza per ossa per tranciare le costole

SEMB
 38-0701
 24 cm, 9 1/2"

Hohlmeißelzange zum Kürzen der Rippenstümpfe

Rib rongeur to shorten the rib stumps

Pinza gubia para acortar los muñones de las costillas

Pincès coupante pour raccourcir les côtes

Pinza per ossa per accorciare le costole



DOYEN
 39-0165
 15,5 cm, 6"

für Kinder, rechts
 for children, right
 para niños, derecha
 pour enfants, à droite
 per bambini, destra

DOYEN
 39-0166
 15,5 cm, 6"

für Kinder, links
 for children, left
 para niños, izquierda
 pour enfants, à gauche
 per bambini, sinistra

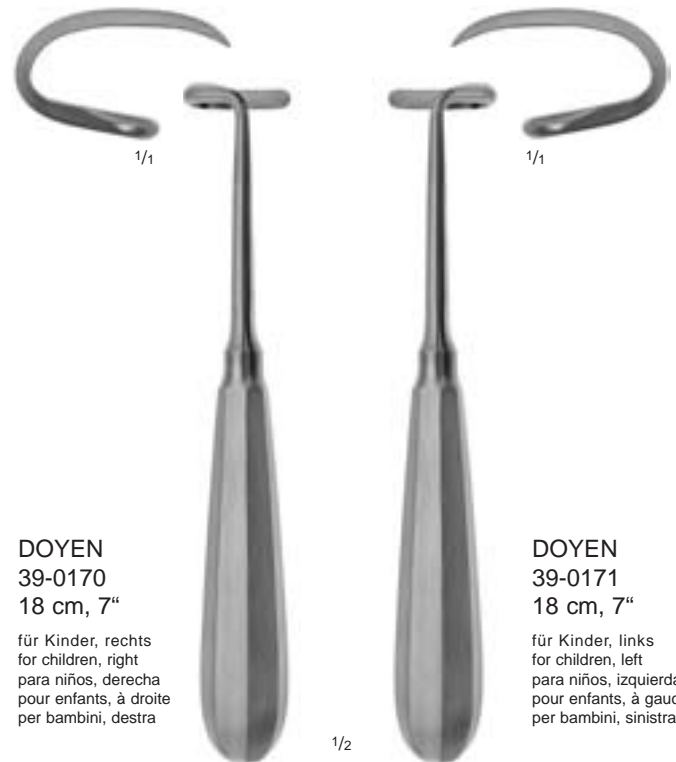

DOYEN
 39-0170
 18 cm, 7"

für Kinder, rechts
 for children, right
 para niños, derecha
 pour enfants, à droite
 per bambini, destra

DOYEN
 39-0171
 18 cm, 7"

für Kinder, links
 for children, left
 para niños, izquierda
 pour enfants, à gauche
 per bambini, sinistra



DOYEN
 39-0175
 17 cm, 6³/₄"

für Erwachsene, rechts
 for adults, right
 para adultos, derecha
 pour adultes, à droite
 per adulti, destra

DOYEN
 39-0176
 17 cm, 6³/₄"

für Erwachsene, links
 for adults, left
 para adultos, izquierda
 pour adultes, à gauche
 per adulti, sinistra



Rippenraspatorien
Rib Raspatories
Periostótomos costales
Rugines à costales
Periostotomi costali

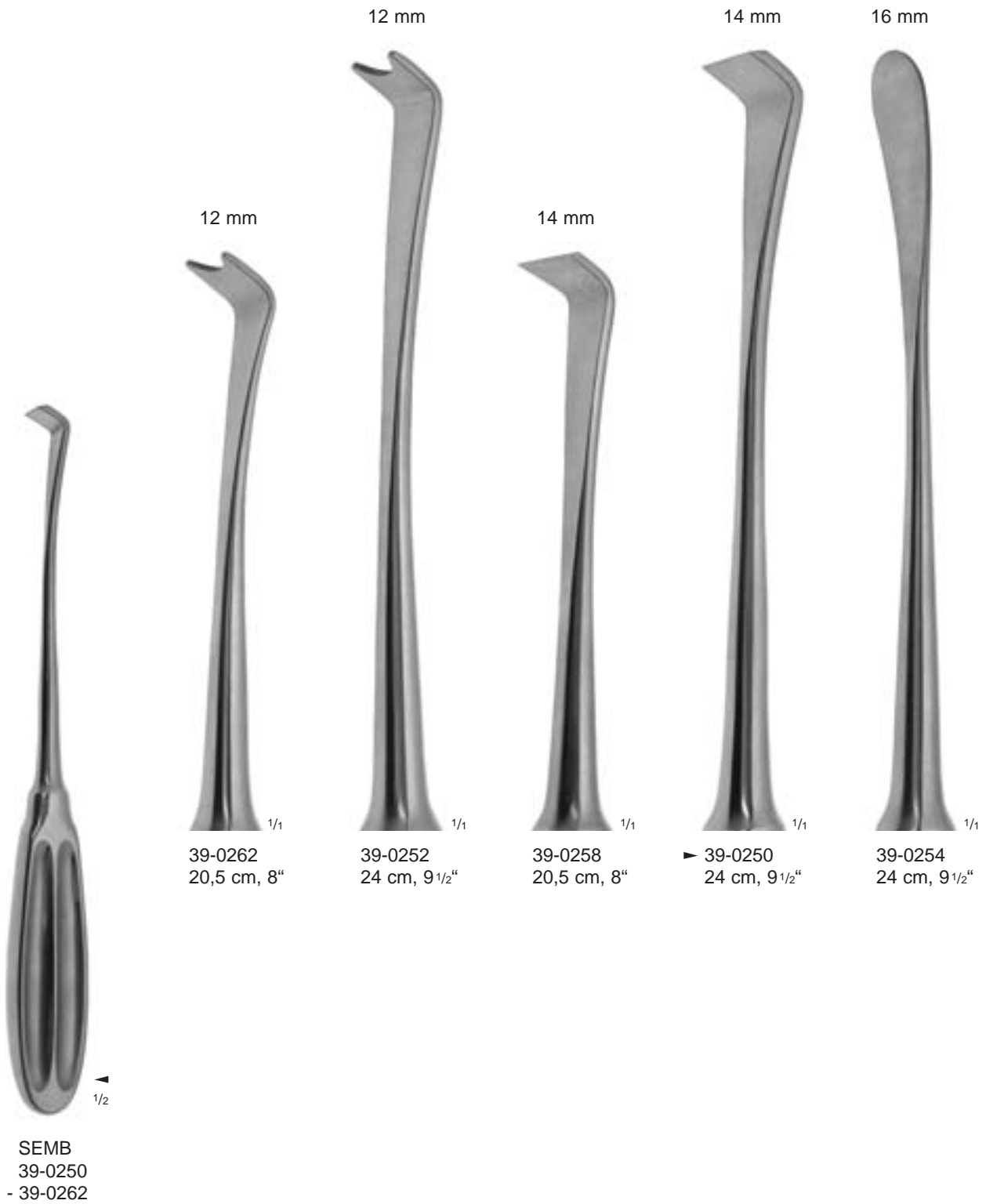

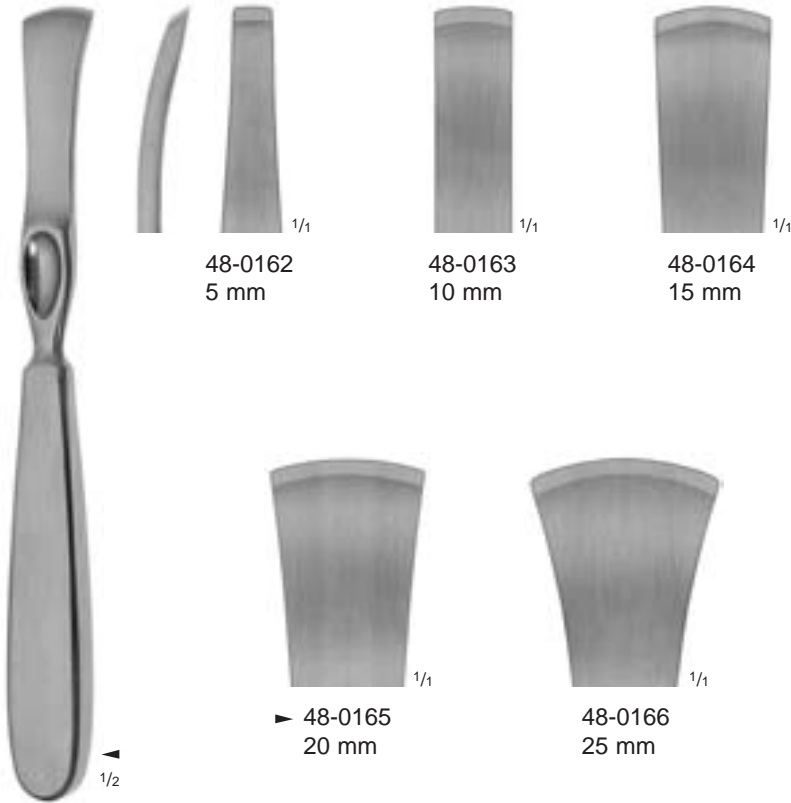

48-0162
5 mm

48-0163
10 mm

48-0164
15 mm

▶ 48-0165
20 mm

48-0166
25 mm

LAMBOTTE
 48-0162
 - 48-0166
 21 cm, 8 1/4"

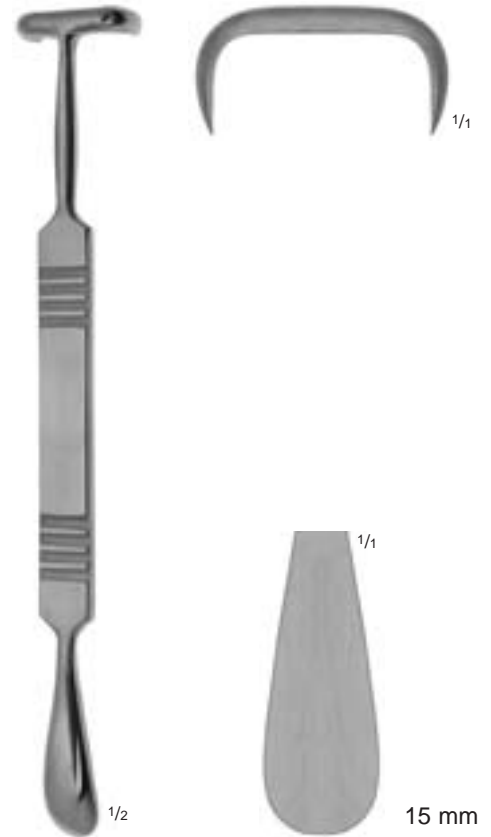

MATSON
 39-0130
 22 cm, 8 3/4"

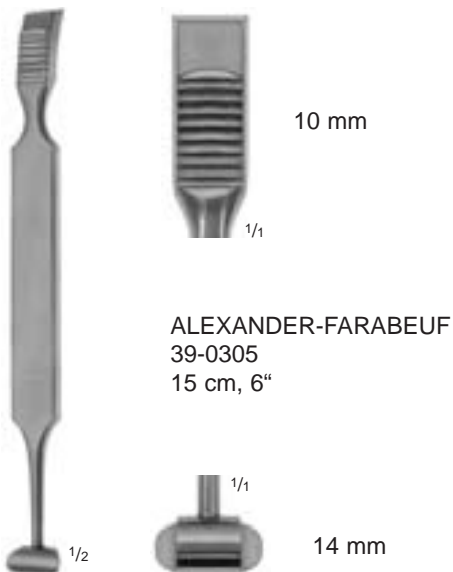

10 mm

ALEXANDER-FARABEUF
 39-0305
 15 cm, 6"

14 mm



12 mm

ALEXANDER-FARABEUF
 39-0302
 21 cm, 8 1/4"

24 mm



Sternotomie-Sperrer aus ALUMINIUM
 Sternotomy Spreaders from ALUMINIUM
 Separadores para esternotomía de ALUMINIO
 Ecarteurs à sternotomie en ALUMINIUM
 Divaricatore per sternotomia in ALLUMINIO

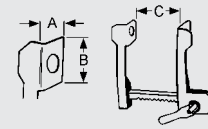

COOLEY

| | A | B | C |
|---------|-------|-------|-------|
| 37-0143 | 12 mm | 16 mm | 70 mm |

für Säuglinge • for babies • para bebés • pour bébé • per neonati

1/3



COOLEY

| | A | B | C |
|---------|-------|-------|--------|
| 37-0144 | 15 mm | 30 mm | 100 mm |

für Kinder • for children • para niños • pour enfants • per bambini

1/3

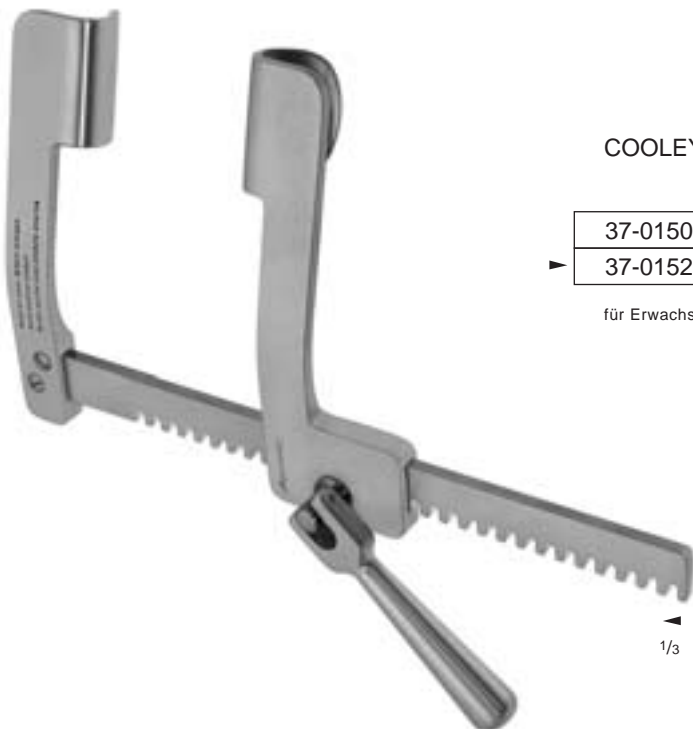

COOLEY

| | A | B | C |
|---------|-------|-------|--------|
| 37-0150 | 20 mm | 45 mm | 140 mm |
| 37-0152 | 30 mm | 50 mm | 185 mm |

für Erwachsene • for adults • para adultos • pour adultes • per adulti

1/3

Sternotomie-Sperrer
 Sternotomy Spreaders
 Separadores para esternotomía
 Ecarteurs à sternotomie
 Divaricatori per sternotomia

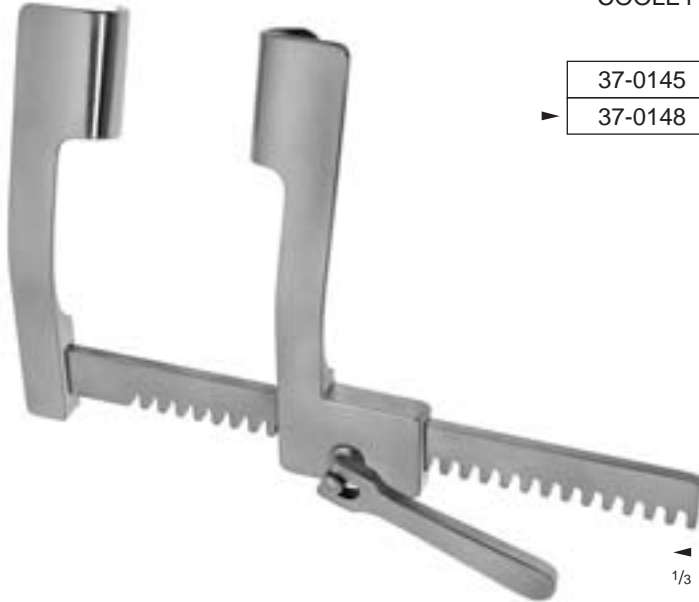
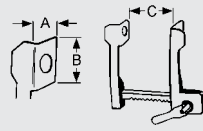

COOLEY

| | A | B | C |
|-----------|-------|-------|--------|
| ▶ 37-0145 | 21 mm | 45 mm | 150 mm |
| ▶ 37-0148 | 35 mm | 50 mm | 175 mm |

37-0145

für Kinder
 for children
 para niños
 pour enfants
 per bambini

37-0148

für Erwachsene
 for adults
 para adultos
 pour adultes
 per adulti

▶ 1/3

mit beweglichen Doppelvalven
 with moveable double blades
 con valvas dobles maleables
 avec doubles valves malléables
 con doppie valve mobili



MORSE

| | A | B | C |
|-----------|-------|-------|--------|
| ▶ 37-0155 | 15 mm | 21 mm | 165 mm |
| ▶ 37-0156 | 22 mm | 27 mm | 200 mm |

37-0155

für Kinder
 for children
 para niños
 pour enfants
 per bambini

37-0156

für Erwachsene
 for adults
 para adultos
 pour adultes
 per adulti

▶ 1/3



Rippensperrer aus ALUMINIUM
 Rib Spreaders from ALUMINIUM
 Separadores costales de ALUMINIO
 Ecarteurs à côtes en ALUMINIUM
 Divaricatori costali in ALLUMINIO

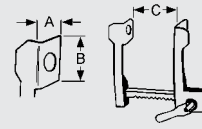

CASTANEDA

| | A | B | C |
|---------|-------|-------|-------|
| 37-0157 | 10 mm | 32 mm | 65 mm |

für Säuglinge • for babies • para bebés • pour bébés • per neonati



CASTANEDA

| | A | B | C |
|---------|-------|-------|-------|
| 37-0158 | 12 mm | 45 mm | 70 mm |

für Kinder • for children • para niños • pour enfants • per bambini



CASTANEDA

| | A | B | C |
|---------|-------|-------|--------|
| 37-0159 | 15 mm | 60 mm | 120 mm |

für Kinder • for children • para niños • pour enfants • per bambini



FINOCHIETTO modif.

| | A | B | C |
|---------|-------|-------|--------|
| 37-0142 | 14 mm | 15 mm | 120 mm |

für Kinder • for children • para niños • pour enfants • per bambini

Rippensperrer aus ALUMINIUM
 Rib Spreaders from ALUMINIUM
 Separadores costales de ALUMINIO
 Ecarteurs à côtes en ALUMINIUM
 Divaricatori costali in ALLUMINIO

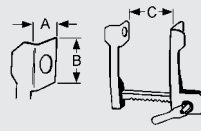

FINOCHIETTO-INFANT

| | A | B | C |
|---------|-------|-------|-------|
| 37-0185 | 15 mm | 15 mm | 75 mm |

für Säuglinge • for babies • para bebés • pour bébés • per neonati



FINOCHIETTO-BABY-HAIGHT

| | A | B | C |
|---------|-------|-------|--------|
| 37-0186 | 31 mm | 31 mm | 100 mm |

für Kinder • for children • para niños • pour enfants • per bambini

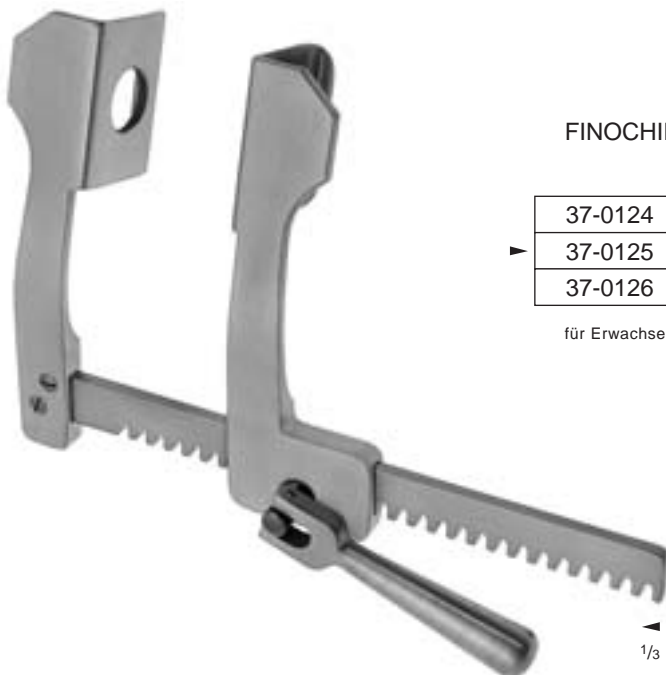

FINOCHIETTO

| | A | B | C |
|---------|-------|-------|--------|
| 37-0124 | 35 mm | 44 mm | 150 mm |
| 37-0125 | 47 mm | 62 mm | 180 mm |
| 37-0126 | 79 mm | 62 mm | 180 mm |

für Erwachsene • for adults • para adultos • pour adultes • per adulti



Rippensperrer aus ALUMINIUM
 Rib Spreaders from ALUMINIUM
 Separadores costales de ALUMINIO
 Ecarteurs à côtes en ALUMINIUM
 Divaricatori costali in ALLUMINIO

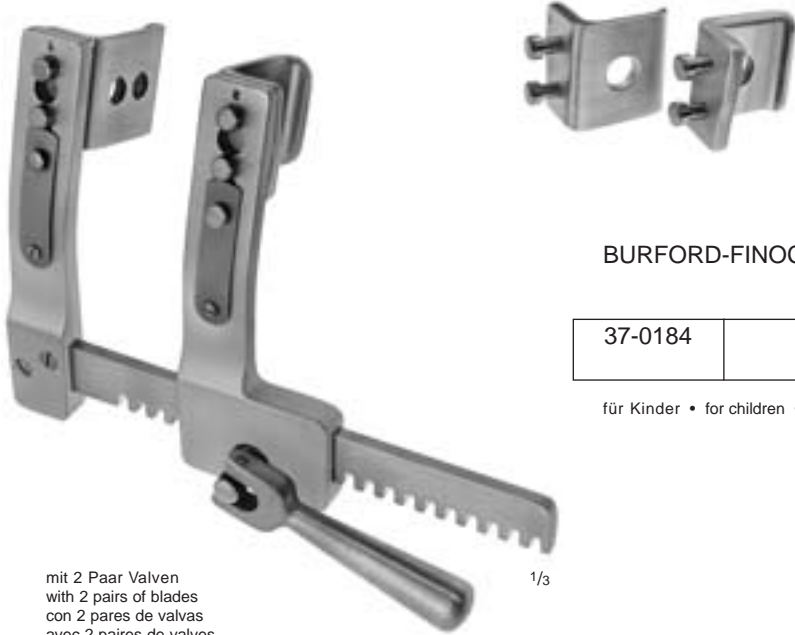
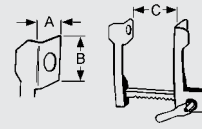

BURFORD-FINOCHIETTO

| | A | B | C |
|---------|----------------|----------------|--------|
| 37-0184 | 34 mm 48 mm | 42 mm 42 mm | 145 mm |

für Kinder • for children • para niños • pour enfants • per bambini

mit 2 Paar Valven
 with 2 pairs of blades
 con 2 pares de valvas
 avec 2 paires de valves
 con 2 paia di valve

1/3

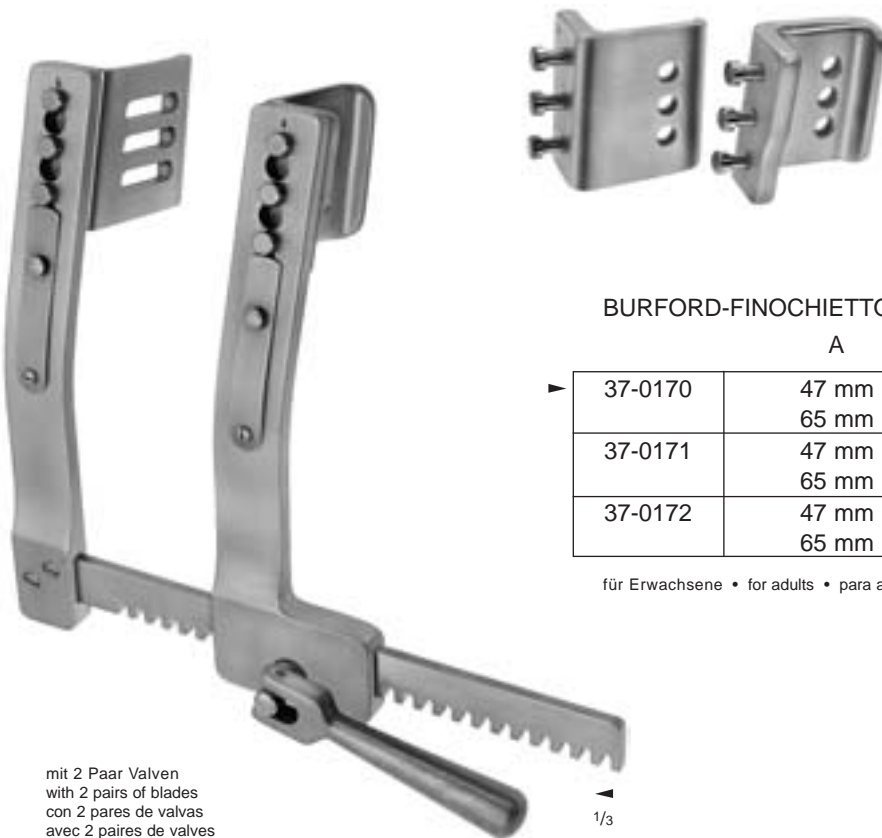

BURFORD-FINOCHIETTO

| | A | B | C |
|-----------|----------------|----------------|--------|
| ▶ 37-0170 | 47 mm 65 mm | 62 mm 62 mm | 185 mm |
| 37-0171 | 47 mm 65 mm | 62 mm 62 mm | 260 mm |
| 37-0172 | 47 mm 65 mm | 62 mm 62 mm | 300 mm |

für Erwachsene • for adults • para adultos • pour adultes • per adulti

mit 2 Paar Valven
 with 2 pairs of blades
 con 2 pares de valvas
 avec 2 paires de valves
 con 2 paia di valve

▶
1/3

Rippensperrer
 Rib Spreaders
 Separadores costales
 Ecarteurs à côtes
 Divaricatori costali

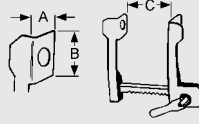

FINOCHIETTO-BABY

| | A | B | C |
|---------|-------|-------|-------|
| 37-0183 | 19 mm | 20 mm | 85 mm |

für Säuglinge • for babies • para bebés • pour bébés • per neonati

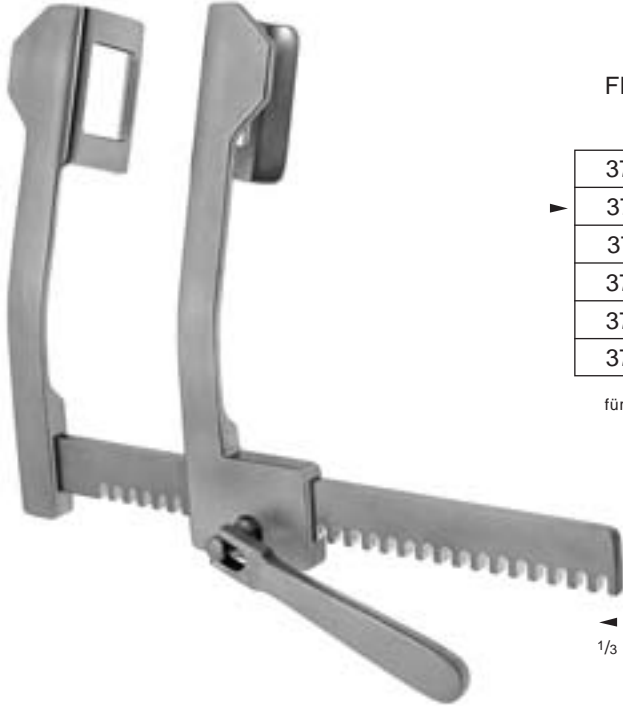

FINOCHIETTO

| | A | B | C |
|---------|-------|-------|--------|
| 37-0100 | 39 mm | 45 mm | 140 mm |
| 37-0110 | 50 mm | 66 mm | 200 mm |
| 37-0111 | 50 mm | 66 mm | 250 mm |
| 37-0120 | 68 mm | 66 mm | 200 mm |
| 37-0121 | 68 mm | 66 mm | 250 mm |
| 37-0122 | 68 mm | 66 mm | 300 mm |

für Erwachsene • for adults • para adultos • pour adultes • per adulti

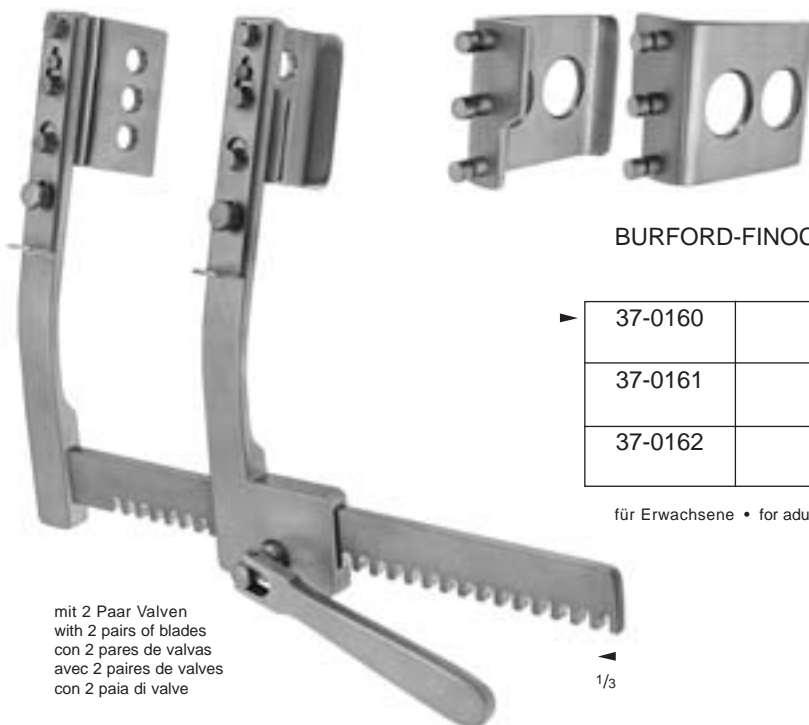

BURFORD-FINOCHIETTO

| | A | B | C |
|---------|----------------|----------------|--------|
| 37-0160 | 48 mm 77 mm | 64 mm 64 mm | 210 mm |
| 37-0161 | 48 mm 77 mm | 64 mm 64 mm | 260 mm |
| 37-0162 | 48 mm 77 mm | 64 mm 64 mm | 300 mm |

für Erwachsene • for adults • para adultos • pour adultes • per adulti

mit 2 Paar Valven
 with 2 pairs of blades
 con 2 pares de valvas
 avec 2 paires de valves
 con 2 paia di valve



Rippensperrer
Rib Spreader
Separador costal
Ecarteur à côtes
Divaricatore costali

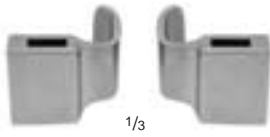
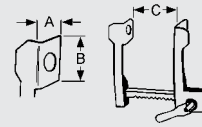

1/3

37-0204
30 x 30 mm (AxB)

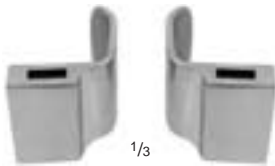

1/3

37-0206
40 x 40 mm (AxB)

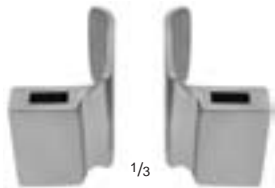

1/3

37-0208
50 x 50 mm (AxB)



1/3

DE BAKEY 37-0200

komplett, bestehend aus:

- 37-0202 1 Sperrer
- 37-0204 2 Seitenvalven 30 x 30 mm (AxB)
- 37-0206 2 Seitenvalven 40 x 40 mm (AxB)
- 37-0208 2 Seitenvalven 50 x 50 mm (AxB)

complete, consisting of:

- 37-0202 1 Spreader
- 37-0204 2 Lateral blades 30 x 30 mm (AxB)
- 37-0206 2 Lateral blades 40 x 40 mm (AxB)
- 37-0208 2 Lateral blades 50 x 50 mm (AxB)

completo, compuesto de:

- 37-0202 1 Separador
- 37-0204 2 Valvas laterales 30 x 30 mm (AxB)
- 37-0206 2 Valvas laterales 40 x 40 mm (AxB)
- 37-0208 2 Valvas laterales 50 x 50 mm (AxB)

complet, composé de:

- 37-0202 1 Ecarteur
- 37-0204 2 Valves latérales 30 x 30 mm (AxB)
- 37-0206 2 Valves latérales 40 x 40 mm (AxB)
- 37-0208 2 Valves latérales 50 x 50 mm (AxB)

completo, composto da:

- 37-0202 1 Divaricatore
- 37-0204 2 Valve laterali 30 x 30 mm (AxB)
- 37-0206 2 Valve laterali 40 x 40 mm (AxB)
- 37-0208 2 Valve laterali 50 x 50 mm (AxB)

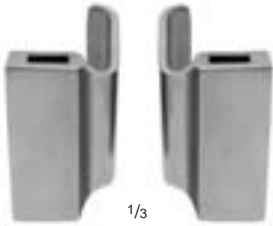
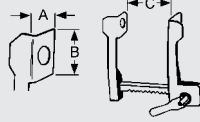

37-0214
 60 x 60 mm
 (AxB)

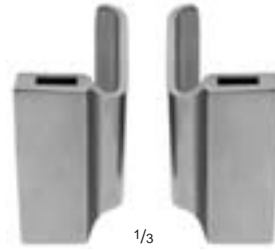

37-0217
 80 x 60 mm
 (AxB)



37-0215
 50 x 80 mm
 (AxB)

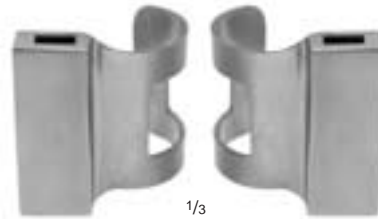

37-0218
 50 x 66 mm
 (AxB)



37-0216
 40 x 100 mm
 (AxB)



**DE BAKEY
 37-0210**

komplett, bestehend aus:

- 37-0212 1 Sperrer
- 37-0214 2 Seitenvalven 60 x 60 mm (AxB)
- 37-0215 2 Seitenvalven 50 x 80 mm (AxB)
- 37-0216 2 Seitenvalven 40 x 100 mm (AxB)

complete, consisting of:

- 37-0212 1 Spreader
- 37-0214 2 Lateral blades 60 x 60 mm (AxB)
- 37-0215 2 Lateral blades 50 x 80 mm (AxB)
- 37-0216 2 Lateral blades 40 x 100 mm (AxB)

completo, compuesto de:

- 37-0212 1 Separador
- 37-0214 2 Valvas laterales 60 x 60 mm (AxB)
- 37-0215 2 Valvas laterales 50 x 80 mm (AxB)
- 37-0216 2 Valvas laterales 40 x 100 mm (AxB)

complet, composé de:

- 37-0212 1 Ecarteur
- 37-0214 2 Valves latérales 60 x 60 mm (AxB)
- 37-0215 2 Valves latérales 50 x 80 mm (AxB)
- 37-0216 2 Valves latérales 40 x 100 mm (AxB)

completo, composto da:

- 37-0212 1 Divaricatore
- 37-0214 2 Valve laterali 60 x 60 mm (AxB)
- 37-0215 2 Valve laterali 50 x 80 mm (AxB)
- 37-0216 2 Valve laterali 40 x 100 mm (AxB)



Rippensperrer
 Rib Spreaders
 Separadores costales
 Ecarteurs à côtes
 Divaricatori costali

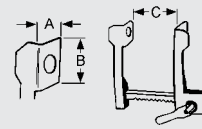

RIENHOFF-FINOCHIETTO

| | A | B | C |
|---------|-------|-------|--------|
| 37-0130 | 30 mm | 32 mm | 155 mm |

1/3



HAIGHT

| | A | B | C |
|---------|-------|-------|-------|
| 37-0222 | 30 mm | 30 mm | 90 mm |

1/3



TUFFIER

| | A | B | C |
|---------|-------|-------|--------|
| 37-0221 | 51 mm | 43 mm | 170 mm |

1/3

Rippensperrer
Rib Spreader
Separador costal
Ecarteur à côtes
Divaricatori costali

Thoraxsperrer
Thoracic Retractor
Separador torácico
Ecarteur thoracique
Divaricatori per il torace

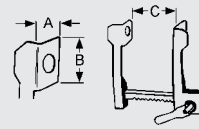

CHEVALIER

| | A | B | C |
|---------|-------|--------|--------|
| 37-0137 | 27 mm | 100 mm | 190 mm |

Rippensperrer
Rib spreader
Separador costal
Ecarteur à côtes
Divaricatore costale

1/3

← 240 mm (C) →



37-0236
75 x 75 mm (AxB)

1/3



37-0234
48 x 65 mm (AxB)

MERCEDES

37-0230

Thoraxsperrer, komplett, bestehend aus:

- 37-0232 1 Sperrer
- 37-0234 2 Seitenvlaven 48 x 65 mm (AxB)
- 37-0236 2 Seitenvlaven 75 x 75 mm (AxB)

Thoracic retractor, complete, consisting of:

- 37-0232 1 Spreader
- 37-0234 2 Lateral blades 48 x 65 mm (AxB)
- 37-0236 2 Lateral blades 75 x 75 mm (AxB)

Separador torácico, completo, compuesto de:

- 37-0232 1 Separador
- 37-0234 2 Valvas laterales 48 x 65 mm (AxB)
- 37-0236 2 Valvas laterales 75 x 75 mm (AxB)

Ecarteur thoracique, complet, composé de:

- 37-0232 1 Ecarteur
- 37-0234 2 Valves latérales 48 x 65 mm (AxB)
- 37-0236 2 Valves latérales 75 x 75 mm (AxB)

Divaricatore per il torace, completo, composto da:

- 37-0232 1 Divaricatore
- 37-0234 2 Valve laterali 48 x 65 mm (AxB)
- 37-0236 2 Valve laterali 75 x 75 mm (AxB)



Rippenkonraktoren
Rib Contractors
Aproximadores para costillas
Rapprocheurs de côtes
Approssimatori costali

Rippensperrer
Rib Spreader
Separador costal
Ecarteur des côtes
Divaricatore costali



1/2

BAILEY-BABY
37-0248
15,5 cm, 6"

Rippenkontraktor
Rib contractor
Aproximador para costillas
Rapprocheur de côtes
Approssimatore costale



1/2

BAILEY
37-0250
20 cm, 8"

Rippenkontraktor, für Kinder
Rib contractor, for children
Aproximador para costillas, para niños
Rapprocheur de côtes, pour enfants
Approssimatore costale, per bambini



1/2

BAILEY-GIBBON
37-0255
20 cm, 8"

Rippenkontraktor, für Erwachsene
Rib contractor, for adults
Aproximador para costillas, para adultos
Rapprocheur de côtes, pour adultes
Approssimatore costale, per adulti



1/2

SELLORS
37-0258
20 cm, 8"

Rippensperrer und -kontraktor mit
drehbaren Klauen
Rib spreader and contractor
with swivel blades
Separador y contractor costal
con garras girables
Ecarteur et rapprocheur des côtes avec
valves orientables
Divaricatore ed approssimatore costale
con valve orientabili

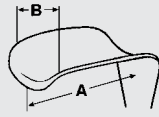

COOLEY
30-0130
25 cm, 10"

rechts
right
derecho
droite
destro



COOLEY
30-0131
25 cm, 10"

rechts, gerieft
right, serrated
derecho, estriado
droite, cannelé
destro, seghettato



COOLEY
30-0132
27,5 cm, 10³/₄"

links
left
izquierdo
gauche
sinistro



Gefäßdilatoren
 Vascular Dilators
 Dilatadores vasculares
 Dilatateurs vasculaires
 Dilatatori vascolari

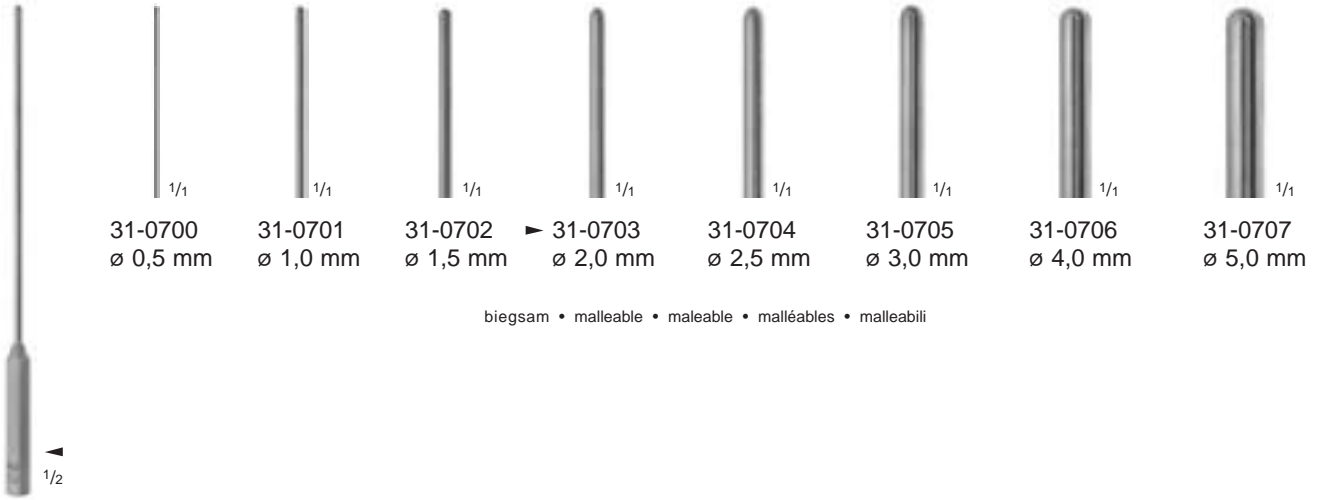

COOLEY
 31-0700
 - 31-0707
 13 cm, 5 1/8"

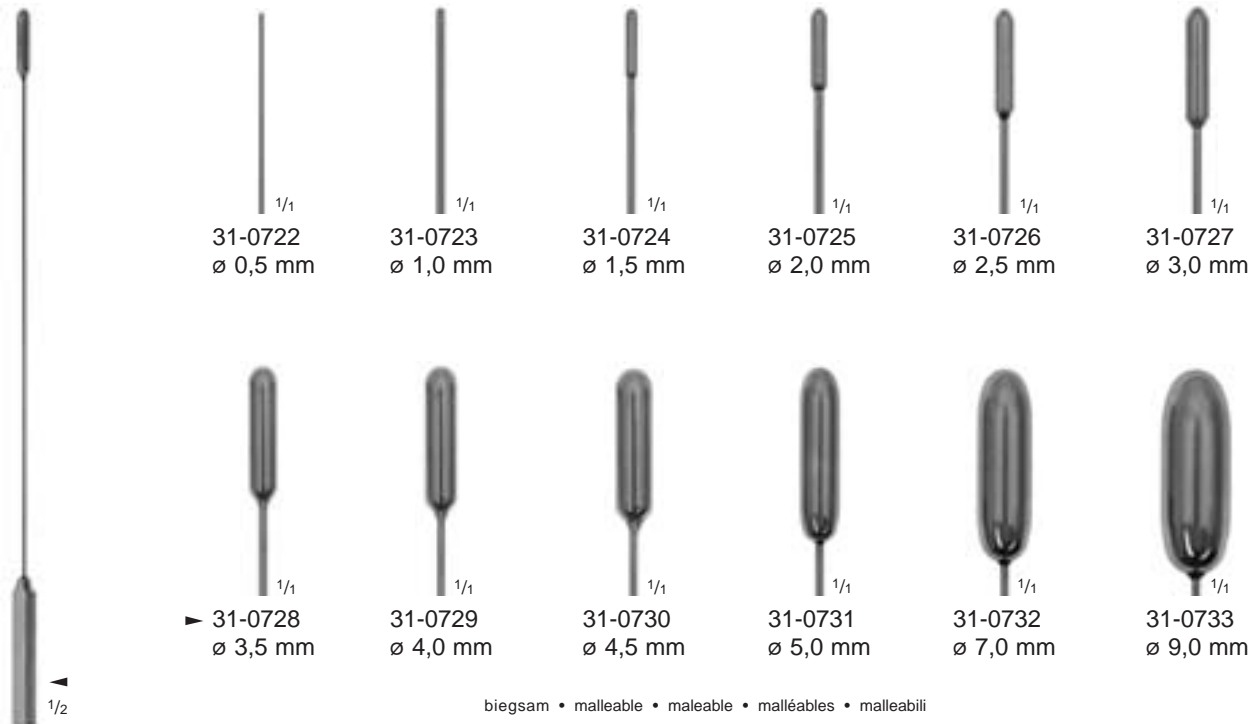

DE BAKEY
 (GARRETT)
 31-0722
 - 31-0733
 19 cm, 7 1/2"



Spreizweite 5 - 20 mm
blade opening from 5 - 20 mm
abertura de 5 a 20 mm
ouverture 5 - 20 mm
apertura mm 5 - 20 mm



COOLEY
31-0758

für Mitralklappenstenosen (Kinder)
for mitral valve (pediatric)
para estenosis mitral (niños)
pour sténoses mitrales (enfants)
per stenosi mitrali (pediatrico)

Spreizweite 8 - 42 mm
blade opening from 8 - 42 mm
abertura de 8 a 42 mm
ouverture 8 - 42 mm
apertura mm 8 - 42 mm



TUBBS
31-0760

für Mitralklappenstenosen
for mitral valve
para estenosis mitral
pour sténoses mitrales
per stenosi mitrali



Intima-Spatel und -Dilatatore
 Intima Spatulas and Dilators
 Espátulas y dilatadores para la íntima
 Spatules et dilateurs
 Spatole e dilatatori per strutture piú interne



1/1
2 mm

ø 1,0 mm



ROBB
31-0600
20,5 cm, 8"

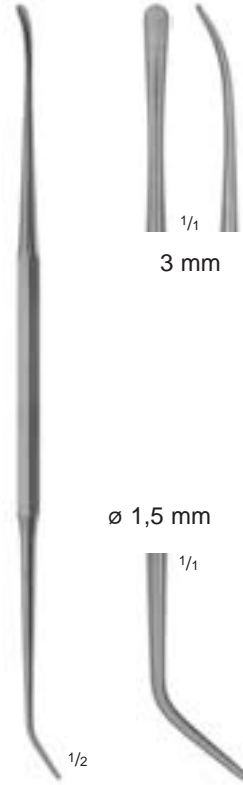

1/1
3 mm

ø 1,5 mm



ROBB
31-0601
20,5 cm, 8"



1/1
4 mm

ø 2,0 mm



ROBB
31-0602
20,5 cm, 8"

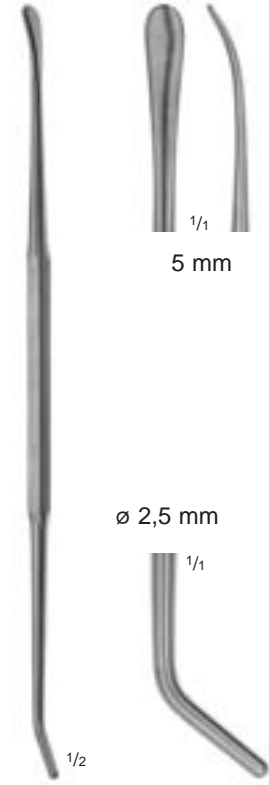

1/1
5 mm

ø 2,5 mm



ROBB
31-0603
20,5 cm, 8"

Intima-Spatel und -Dilatatore • Intima spatulas and dilators • Espátulas y dilatadores para la íntima • Spatules et dilateurs pour la tunique interne • Spatole e dilatatori per intima



1/1
3 mm
31-0615
17 cm, 6³/₄"



1/1
3 mm
▶ 31-0616
17 cm, 6³/₄"

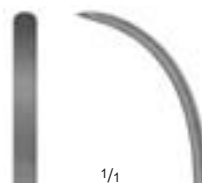

1/1
3 mm
31-0617
17 cm, 6³/₄"

LEMMON
31-0615
- 31-0617

Intima-Spatel
Intima spatulas
Espátulas para la íntima
Spatules pour la tunique interne
Spatole per intima

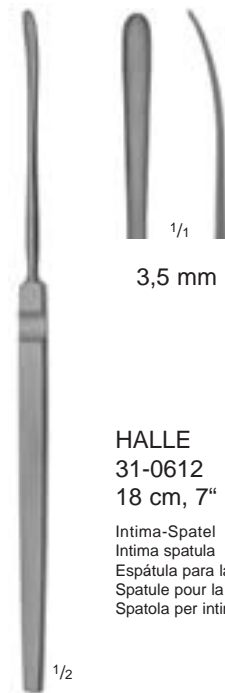

1/1
3,5 mm
HALLE
31-0612
18 cm, 7"

Intima-Spatel
Intima spatula
Espátula para la íntima
Spatule pour la tunique interne
Spatola per intima

Intima-Spatel

Intima Spatulas

Espátulas para la íntima

Spatules pour la tunique interne

Spatole per intima

Intima-Messer

Intima Knife

Cuchillo para la íntima

Couteau pour la tunique interne

Bisturi per intima

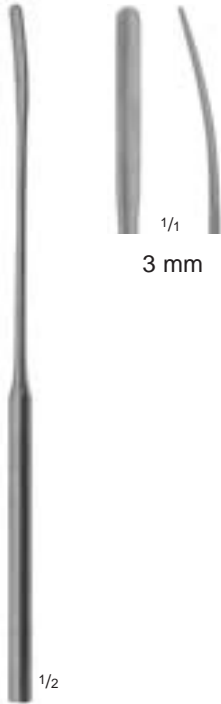

31-0608
18,5 cm, 7 1/4"



31-0609
21,5 cm, 8 1/2"

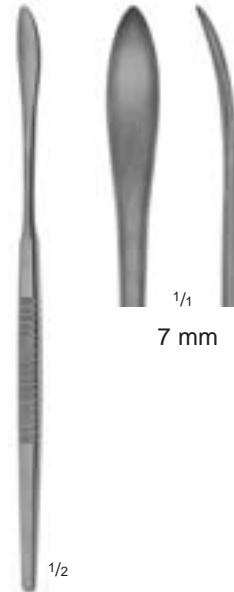

SCHMID
31-0605
15,5 cm, 6"

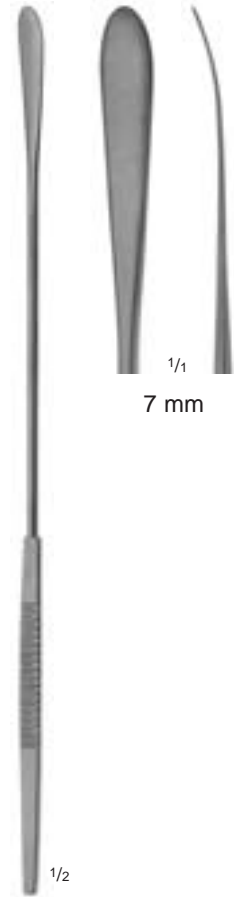

SCHMID
31-0607
23,5 cm, 9 1/4"

Intima-Spatel • Intima spatulas • Espátulas para la íntima • Spatules pour la tunique interne • Spatole per intima



CANNON
31-0632
15 cm, 6"
Intima-Messer
Intima knife
Cuchillo para la íntima
Couteau pour la tunique interne
Bisturi per intima



CANNON
31-0634
18 cm, 7"
Intima-Spatel
Intima spatula
Espátula para la íntima
Spatule pour la tunique interne
Spatola per intima



Endarterektomiestripper

Endarterectomy Stripper
Sondas para endarterectomía
Sondes à endartérectomie
Tiravene per endarterectomia



1/1

CANNON

- ▶ **31-0660** ø 7,0 x 7,8 mm
 - 31-0661** ø 8,0 x 9,0 mm
 - 31-0662** ø 9,0 x 10,0 mm
- 24 cm, 9 1/2"

oval, biegsam
oval, malleable
ovales, maleables
ovales, malléables
ovali, malleabili



1/1

CANNON

- ▶ **31-0665** ø 2,8 x 3,1 mm
 - 31-0666** ø 3,9 x 4,3 mm
 - 31-0667** ø 5,0 x 5,7 mm
 - 31-0668** ø 6,0 x 6,7 mm
 - ▶ **31-0669** ø 7,0 x 8,0 mm
 - 31-0670** ø 7,8 x 9,0 mm
 - 31-0671** ø 8,7 x 10,2 mm
 - 31-0672** ø 9,4 x 10,8 mm
 - 31-0673** ø 15,5 x 17,3 mm
 - 31-0674** ø 18,0 x 20,5 mm
 - 31-0675** ø 20,2 x 23,2 mm
- 33 cm, 13"

oval, flexibel
oval, flexible
ovales, flexibles
ovales, flexibles
ovali, flessibili



1/1

- 31-0618** ø 2,0 mm
 - 31-0619** ø 3,0 mm
 - 31-0620** ø 4,0 mm
 - 31-0622** ø 6,0 mm
 - ▶ **31-0623** ø 7,0 mm
 - 31-0624** ø 8,5 mm
 - 31-0626** ø 10,0 mm
 - 31-0628** ø 12,0 mm
 - 31-0630** ø 14,0 mm
- 50 cm, 19 3/4"

rund, flexibel
round, flexible
redondos, flexibles
rondes, flexibles
rotonde, flessibili



1/2

31-0635

8,5 cm, 3 3/8"

Handgriff für 31-0618 - 31-0675
Handle for 31-0618 - 31-0675
Mango para 31-0618 - 31-0675
Manche pour 31-0618 - 31-0675
Manico per 31-0618 - 31-0675

Endarterektomie-Satz

Endarterectomy Set

Juego para endarterectomía

Jeu pour endartérectomie

Set per endarterectomia

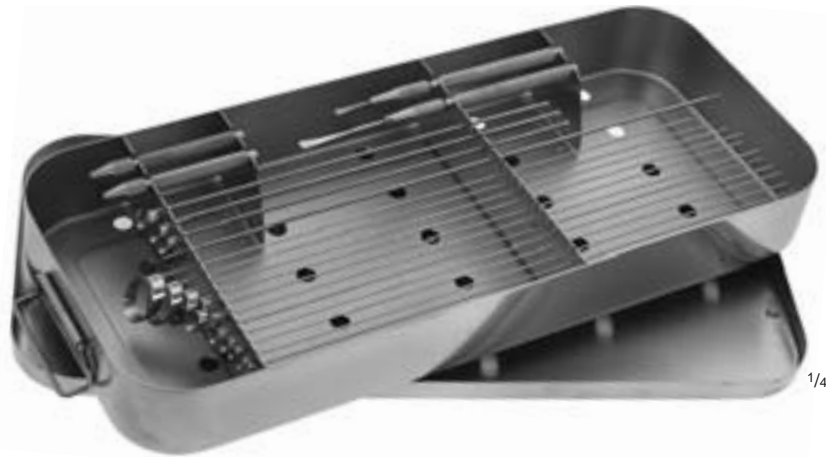

1/4

CANNON

31-0690

Endarterektomie-Satz, bestehend aus:

| | | | |
|---------|---|--|--------------------------------|
| 31-0660 | 1 | Endarterektomiestripper, oval, biegsam, | ø 7,0 x 7,8 mm, 24 cm, 9 1/2" |
| 31-0661 | 1 | Endarterektomiestripper, oval, biegsam, | ø 8,0 x 9,0 mm, 24 cm, 9 1/2" |
| 31-0662 | 1 | Endarterektomiestripper, oval, biegsam, | ø 9,0 x 10,0 mm, 24 cm, 9 1/2" |
| 31-0665 | 1 | Endarterektomiestripper, oval, flexibel, | ø 2,8 x 3,1 mm, 33 cm, 13 " |
| 31-0666 | 1 | Endarterektomiestripper, oval, flexibel, | ø 3,9 x 4,3 mm, 33 cm, 13 " |
| 31-0667 | 1 | Endarterektomiestripper, oval, flexibel, | ø 5,0 x 5,7 mm, 33 cm, 13 " |
| 31-0668 | 1 | Endarterektomiestripper, oval, flexibel, | ø 6,0 x 6,7 mm, 33 cm, 13 " |
| 31-0669 | 1 | Endarterektomiestripper, oval, flexibel, | ø 7,0 x 8,0 mm, 33 cm, 13 " |
| 31-0670 | 1 | Endarterektomiestripper, oval, flexibel, | ø 7,8 x 9,0 mm, 33 cm, 13 " |
| 31-0671 | 1 | Endarterektomiestripper, oval, flexibel, | ø 8,7 x 10,2 mm, 33 cm, 13 " |
| 31-0672 | 1 | Endarterektomiestripper, oval, flexibel, | ø 9,4 x 10,8 mm, 33 cm, 13 " |
| 31-0673 | 1 | Endarterektomiestripper, oval, flexibel, | ø 15,5 x 17,3 mm, 33 cm, 13 " |
| 31-0674 | 1 | Endarterektomiestripper, oval, flexibel, | ø 18,0 x 20,5 mm, 33 cm, 13 " |
| 31-0675 | 1 | Endarterektomiestripper, oval, flexibel, | ø 20,2 x 23,2 mm, 33 cm, 13 " |
| 31-0677 | 1 | Einführungsinstrument, flexibel, 32 cm, | 12 1/2" |
| 31-0632 | 1 | Intima-Messer, 4,7 mm, 15 cm, | 6" |
| 31-0634 | 1 | Intima-Spatel, 5,6 mm, 18 cm, | 7" |
| 31-0635 | 2 | Handgriffe für Endarterektomiestripper, | 8,5 mm, 3 3/8" |
| 07-0782 | 1 | Sterilisier-Etui 430 x 180 x 55 mm | |

Juego para endarterectomía, compuesto de:

| | | | |
|---------|---|--|--------------------------------|
| 31-0660 | 1 | Sonda para endarterectomía, oval, maleable, | ø 7,0 x 7,8 mm, 24 cm, 9 1/2" |
| 31-0661 | 1 | Sonda para endarterectomía, oval, maleable, | ø 8,0 x 9,0 mm, 24 cm, 9 1/2" |
| 31-0662 | 1 | Sonda para endarterectomía, oval, maleable, | ø 9,0 x 10,0 mm, 24 cm, 9 1/2" |
| 31-0665 | 1 | Sonda para endarterectomía, oval, flexible, | ø 2,8 x 3,1 mm, 33 cm, 13 " |
| 31-0666 | 1 | Sonda para endarterectomía, oval, flexible, | ø 3,9 x 4,3 mm, 33 cm, 13 " |
| 31-0667 | 1 | Sonda para endarterectomía, oval, flexible, | ø 5,0 x 5,7 mm, 33 cm, 13 " |
| 31-0668 | 1 | Sonda para endarterectomía, oval, flexible, | ø 6,0 x 6,7 mm, 33 cm, 13 " |
| 31-0669 | 1 | Sonda para endarterectomía, oval, flexible, | ø 7,0 x 8,0 mm, 33 cm, 13 " |
| 31-0670 | 1 | Sonda para endarterectomía, oval, flexible, | ø 7,8 x 9,0 mm, 33 cm, 13 " |
| 31-0671 | 1 | Sonda para endarterectomía, oval, flexible, | ø 8,7 x 10,2 mm, 33 cm, 13 " |
| 31-0672 | 1 | Sonda para endarterectomía, oval, flexible, | ø 9,4 x 10,8 mm, 33 cm, 13 " |
| 31-0673 | 1 | Sonda para endarterectomía, oval, flexible, | ø 15,5 x 17,3 mm, 33 cm, 13 " |
| 31-0674 | 1 | Sonda para endarterectomía, oval, flexible, | ø 18,0 x 20,5 mm, 33 cm, 13 " |
| 31-0675 | 1 | Sonda para endarterectomía, oval, flexible, | ø 20,2 x 23,2 mm, 33 cm, 13 " |
| 31-0677 | 1 | Instrumento conductor, flexible, 32 cm, | 12 1/2" |
| 31-0632 | 1 | Cuchillo para la íntima, 4,7 mm, 15 cm, | 6" |
| 31-0634 | 1 | Espátula para la íntima, 5,6 mm, 18 cm, | 7" |
| 31-0635 | 2 | Mangos para las sondas para endarterectomía, | 8,5 mm, 3 3/8" |
| 07-0782 | 1 | Estuche para esterilizar, 430 x 180 x 55 mm | |

Set per endarterectomia, composto da:

| | | | |
|---------|---|--|--------------------------------|
| 31-0660 | 1 | Tiravene per endarterectomia, ovali, malleabile, | ø 7,0 x 7,8 mm, 24 cm, 9 1/2" |
| 31-0661 | 1 | Tiravene per endarterectomia, ovali, malleabile, | ø 8,0 x 9,0 mm, 24 cm, 9 1/2" |
| 31-0662 | 1 | Tiravene per endarterectomia, ovali, malleabile, | ø 9,0 x 10,0 mm, 24 cm, 9 1/2" |
| 31-0665 | 1 | Tiravene per endarterectomia, ovali, flessibile, | ø 2,8 x 3,1 mm, 33 cm, 13 " |
| 31-0666 | 1 | Tiravene per endarterectomia, ovali, flessibile, | ø 3,9 x 4,3 mm, 33 cm, 13 " |
| 31-0667 | 1 | Tiravene per endarterectomia, ovali, flessibile, | ø 5,0 x 5,7 mm, 33 cm, 13 " |
| 31-0668 | 1 | Tiravene per endarterectomia, ovali, flessibile, | ø 6,0 x 6,7 mm, 33 cm, 13 " |
| 31-0669 | 1 | Tiravene per endarterectomia, ovali, flessibile, | ø 7,0 x 8,0 mm, 33 cm, 13 " |
| 31-0670 | 1 | Tiravene per endarterectomia, ovali, flessibile, | ø 7,8 x 9,0 mm, 33 cm, 13 " |
| 31-0671 | 1 | Tiravene per endarterectomia, ovali, flessibile, | ø 8,7 x 10,2 mm, 33 cm, 13 " |
| 31-0672 | 1 | Tiravene per endarterectomia, ovali, flessibile, | ø 9,4 x 10,8 mm, 33 cm, 13 " |
| 31-0673 | 1 | Tiravene per endarterectomia, ovali, flessibile, | ø 15,5 x 17,3 mm, 33 cm, 13 " |
| 31-0674 | 1 | Tiravene per endarterectomia, ovali, flessibile, | ø 18,0 x 20,5 mm, 33 cm, 13 " |
| 31-0675 | 1 | Tiravene per endarterectomia, ovali, flessibile, | ø 20,2 x 23,2 mm, 33 cm, 13 " |
| 31-0677 | 1 | Strumento introduttore, flessibile, 32 cm, | 12 1/2" |
| 31-0632 | 1 | Bisturi per intima, 4,7 mm, 15 cm, | 6" |
| 31-0634 | 1 | Dissettore per intima, 5,6 mm, 18 cm, | 7" |
| 31-0635 | 2 | Manico per tiravene, 8,5 mm, 3 3/8" | |
| 07-0782 | 1 | Cestello per sterilizzazione 430 x 180 x 55 mm | |

Endarterectomy set, consisting of:

| | | | |
|---------|---|---|--------------------------------|
| 31-0660 | 1 | Endarterectomy stripper, oval, malleable, | ø 7,0 x 7,8 mm, 24 cm, 9 1/2" |
| 31-0661 | 1 | Endarterectomy stripper, oval, malleable, | ø 8,0 x 9,0 mm, 24 cm, 9 1/2" |
| 31-0662 | 1 | Endarterectomy stripper, oval, malleable, | ø 9,0 x 10,0 mm, 24 cm, 9 1/2" |
| 31-0665 | 1 | Endarterectomy stripper, oval, flexible, | ø 2,8 x 3,1 mm, 33 cm, 13 " |
| 31-0666 | 1 | Endarterectomy stripper, oval, flexible, | ø 3,9 x 4,3 mm, 33 cm, 13 " |
| 31-0667 | 1 | Endarterectomy stripper, oval, flexible, | ø 5,0 x 5,7 mm, 33 cm, 13 " |
| 31-0668 | 1 | Endarterectomy stripper, oval, flexible, | ø 6,0 x 6,7 mm, 33 cm, 13 " |
| 31-0669 | 1 | Endarterectomy stripper, oval, flexible, | ø 7,0 x 8,0 mm, 33 cm, 13 " |
| 31-0670 | 1 | Endarterectomy stripper, oval, flexible, | ø 7,8 x 9,0 mm, 33 cm, 13 " |
| 31-0671 | 1 | Endarterectomy stripper, oval, flexible, | ø 8,7 x 10,2 mm, 33 cm, 13 " |
| 31-0672 | 1 | Endarterectomy stripper, oval, flexible, | ø 9,4 x 10,8 mm, 33 cm, 13 " |
| 31-0673 | 1 | Endarterectomy stripper, oval, flexible, | ø 15,5 x 17,3 mm, 33 cm, 13 " |
| 31-0674 | 1 | Endarterectomy stripper, oval, flexible, | ø 18,0 x 20,5 mm, 33 cm, 13 " |
| 31-0675 | 1 | Endarterectomy stripper, oval, flexible, | ø 20,2 x 23,2 mm, 33 cm, 13 " |
| 31-0677 | 1 | Introducing instrument, flexible, 32 cm, | 12 1/2" |
| 31-0632 | 1 | Intima knife, 4,7 mm, 15 cm, | 6" |
| 31-0634 | 1 | Intima dissector, 5,6 mm, 18 cm, | 7" |
| 31-0635 | 2 | Handles for endarterectomy strippers, | 8,5 mm, 3 3/8" |
| 07-0782 | 1 | Sterilizing case 430 x 180 x 55 mm | |

Jeu pour endartérectomie, composé de:

| | | | |
|---------|---|---|--------------------------------|
| 31-0660 | 1 | Stripper pour endartérectomie, ovales, malléable, | ø 7,0 x 7,8 mm, 24 cm, 9 1/2" |
| 31-0661 | 1 | Stripper pour endartérectomie, ovales, malléable, | ø 8,0 x 9,0 mm, 24 cm, 9 1/2" |
| 31-0662 | 1 | Stripper pour endartérectomie, ovales, malléable, | ø 9,0 x 10,0 mm, 24 cm, 9 1/2" |
| 31-0665 | 1 | Stripper pour endartérectomie, ovales, flexibles, | ø 2,8 x 3,1 mm, 33 cm, 13 " |
| 31-0666 | 1 | Stripper pour endartérectomie, ovales, flexibles, | ø 3,9 x 4,3 mm, 33 cm, 13 " |
| 31-0667 | 1 | Stripper pour endartérectomie, ovales, flexibles, | ø 5,0 x 5,7 mm, 33 cm, 13 " |
| 31-0668 | 1 | Stripper pour endartérectomie, ovales, flexibles, | ø 6,0 x 6,7 mm, 33 cm, 13 " |
| 31-0669 | 1 | Stripper pour endartérectomie, ovales, flexibles, | ø 7,0 x 8,0 mm, 33 cm, 13 " |
| 31-0670 | 1 | Stripper pour endartérectomie, ovales, flexibles, | ø 7,8 x 9,0 mm, 33 cm, 13 " |
| 31-0671 | 1 | Stripper pour endartérectomie, ovales, flexibles, | ø 8,7 x 10,2 mm, 33 cm, 13 " |
| 31-0672 | 1 | Stripper pour endartérectomie, ovales, flexibles, | ø 9,4 x 10,8 mm, 33 cm, 13 " |
| 31-0673 | 1 | Stripper pour endartérectomie, ovales, flexibles, | ø 15,5 x 17,3 mm, 33 cm, 13 " |
| 31-0674 | 1 | Stripper pour endartérectomie, ovales, flexibles, | ø 18,0 x 20,5 mm, 33 cm, 13 " |
| 31-0675 | 1 | Stripper pour endartérectomie, ovales, flexibles, | ø 20,2 x 23,2 mm, 33 cm, 13 " |
| 31-0677 | 1 | Instrument d'introduction, flexible, 32 cm, | 12 1/2" |
| 31-0632 | 1 | Couteau, 4,7 mm, 15 cm, | 6" |
| 31-0634 | 1 | Spatule dissecteur, 5,6 mm, 18 cm, | 7" |
| 31-0635 | 2 | Manches pour stripper, 8,5 mm, 3 3/8" | |
| 07-0782 | 1 | Boîte stérilisable 430 x 180 x 55 mm | |



Tunnelier-Satz

Tunneling Set

Juego para tunelar

Jeu pour tunneliser

Set per scanalare



1/4

31-0870

Tunnelier-Satz, bestehend aus:

- 31-0871 2 Universal Tunnelier-Griffe
- 31-0872 1 Tunnelier-Schaft, gebogen, 225 mm
- 31-0873 1 Tunnelier-Schaft, gerade, 225 mm
- 31-0874 1 Tunnelier-Schaft, gebogen, 540 mm
- 31-0875 2 Oliven-Aufsätze, ø 5 mm
- 31-0876 2 Oliven-Aufsätze, ø 6 mm
- 31-0877 2 Oliven-Aufsätze, ø 7 mm
- 31-0878 2 Oliven-Aufsätze, ø 8 mm
- 31-0879 2 Oliven-Aufsätze, ø 10 mm
- 31-0880 2 Oliven-Aufsätze, ø 12 mm
- 31-0881 1 Venen-Aufsatz
- 31-0882 1 LUER-Adapter
- 31-0883 1 Schlüssel
- 07-0825 1 Halteplatte für Aufsätze
- 07-0826 1 Sterilisierbehälter 550 x 115 x 35 mm

Tunneling set, consisting of:

- 31-0871 2 Universal handles
- 31-0872 1 Tunneling shaft, curved, 225 mm
- 31-0873 1 Tunneling shaft, straight, 225 mm
- 31-0874 1 Tunneling shaft, curved, 540 mm
- 31-0875 2 Bullet tips, ø 5 mm
- 31-0876 2 Bullet tips, ø 6 mm
- 31-0877 2 Bullet tips, ø 7 mm
- 31-0878 2 Bullet tips, ø 8 mm
- 31-0879 2 Bullet tips, ø 10 mm
- 31-0880 2 Bullet tips, ø 12 mm
- 31-0881 1 Vein tip
- 31-0882 1 LUER-Adapter
- 31-0883 1 Key
- 07-0825 1 Plate for tips only
- 07-0826 1 Sterilizing case 550 x 115 x 35 mm

Juego para tunelar, compuesto de:

- 31-0871 2 Mangos universales para tunelar
- 31-0872 1 Vástago para tunelar, curvo, 225 mm
- 31-0873 1 Vástago para tunelar, recto, 225 mm
- 31-0874 1 Vástago para tunelar, curvo, 540 mm
- 31-0875 2 Olivas, ø 5 mm
- 31-0876 2 Olivas, ø 6 mm
- 31-0877 2 Olivas, ø 7 mm
- 31-0878 2 Olivas, ø 8 mm
- 31-0879 2 Olivas, ø 10 mm
- 31-0880 2 Olivas, ø 12 mm
- 31-0881 1 Punta para venas
- 31-0882 1 Punta con adaptador LUER
- 31-0883 1 Llave
- 07-0825 1 Soporte para puntas
- 07-0826 1 Estuche para esterilizar 550 x 115 x 35 mm

Jeu pour tunneliser, composé de:

- 31-0871 2 Manche universel pour tunneliser
- 31-0872 1 Tige pour tunneliser, courbe, 225 mm
- 31-0873 1 Tige pour tunneliser, droite, 225 mm
- 31-0874 1 Tige pour tunneliser, courbe, 540 mm
- 31-0875 2 Olives, ø 5 mm
- 31-0876 2 Olives, ø 6 mm
- 31-0877 2 Olives, ø 7 mm
- 31-0878 2 Olives, ø 8 mm
- 31-0879 2 Olives, ø 10 mm
- 31-0880 2 Olives, ø 12 mm
- 31-0881 1 Embout pour veines
- 31-0882 1 Adaptateur LUER
- 31-0883 1 Clef
- 07-0825 1 Support pour embouts
- 07-0826 1 Boîte pour stériliser 550 x 115 x 35 mm

Set per scanalare, composto da:

- 31-0871 2 Manici universali
- 31-0872 1 Asta, curva, 225 mm
- 31-0873 1 Asta, retta, 225 mm
- 31-0874 1 Asta, curva, 540 mm
- 31-0875 2 Olive, ø 5 mm
- 31-0876 2 Olive, ø 6 mm
- 31-0877 2 Olive, ø 7 mm
- 31-0878 2 Olive, ø 8 mm
- 31-0879 2 Olive, ø 10 mm
- 31-0880 2 Olive, ø 12 mm
- 31-0881 1 Testa adattatore per vene
- 31-0882 1 Adattatore LUER
- 31-0883 1 Chiave
- 07-0825 1 Supporto per olive
- 07-0826 1 Cestello per sterilizzazione 550 x 115 x 35 mm

Ersatzteile • Spare parts • Piezas de repuesto • Pièces de rechange • Pezzi di ricambio



1/3

31-0871



1/3

31-0883



1/1

31-0875
ø 5 mm



1/1

31-0876
ø 6 mm



1/1

31-0877
ø 7 mm



1/1

31-0878
ø 8 mm



1/1

31-0879
ø 10 mm



1/1

31-0880
ø 12 mm



1/1

31-0881



1/1

31-0882

Tunnelier-Instrumente für Bypass-Implantation

Tunneling Instruments for Bypass Grafting

Instrumentos para tunelar e injertar Bypass

Tunnelisateur pour bypass

Strumenti per scanalare per trapiantare, bypass

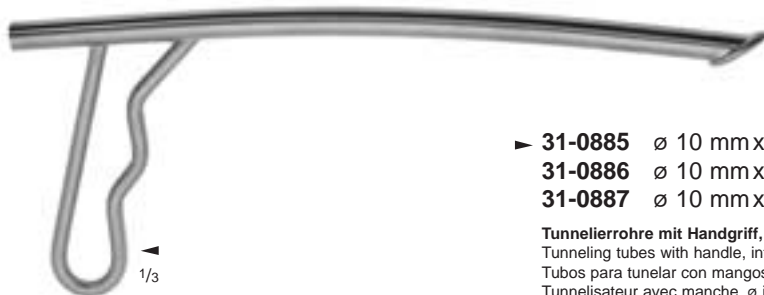

► **31-0885** ø 10 mm x 280 mm

31-0886 ø 10 mm x 380 mm

31-0887 ø 10 mm x 680 mm

Tunnelierrohre mit Handgriff, Innendurchmesser 10 mm

Tunneling tubes with handle, internal diameter 10 mm

Tubos para tunelar con mangos, ø interior 10 mm

Tunnelisateur avec manche, ø intérieur 10 mm

Tubo per scanalare con manico, ø int. 10 mm

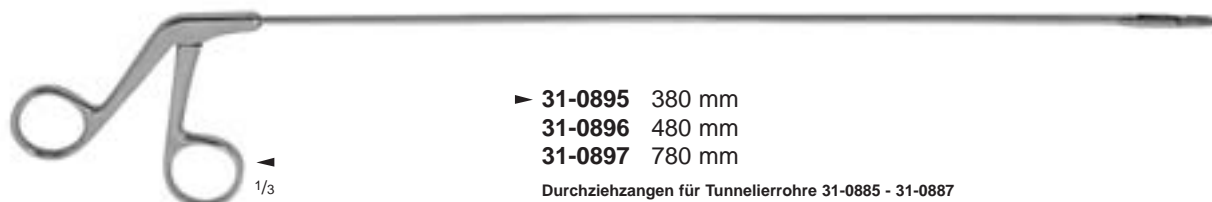

► **31-0895** 380 mm

31-0896 480 mm

31-0897 780 mm

Durchziehungen für Tunnelierrohre 31-0885 - 31-0887

Forceps for tunneling tubes 31-0885 - 31-0887

Pinzas pasadoras para los tubos para tunelar 31-0885 - 31-0887

Pinces pour tunnelisateur 31-0885 - 31-0887

Pinza per tubi per scanalare 31-0885 - 31-0887

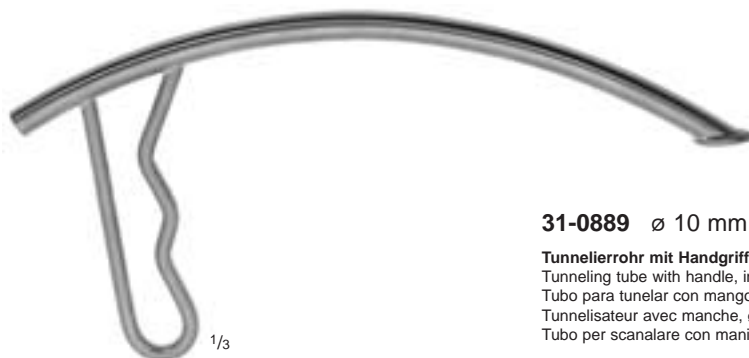

31-0889 ø 10 mm x 280 mm

Tunnelierrohr mit Handgriff, Innendurchmesser 10 mm

Tunneling tube with handle, internal diameter 10 mm

Tubo para tunelar con mango, ø interior 10 mm

Tunnelisateur avec manche, ø intérieur 10 mm

Tubo per scanalare con manico, ø int. 10 mm



31-0898 380 mm

Durchziehange für Tunnelierrohr 31-0889

Forceps for tunneling tube 31-0889

Pinza pasadora para tubo para tunelar 31-0889

Pinces pour tunnelisateur 31-0889

Pinza per tubo per scanalare 31-0889



Tourniquets

Tourniquets
Torniquetes
Tourniquets
Tourniquets
Tourniquets

Biopsiekanülen

Biopsy Needles
Agujas de biopsia
Aiguilles à biopsie
Aghi per biopsia

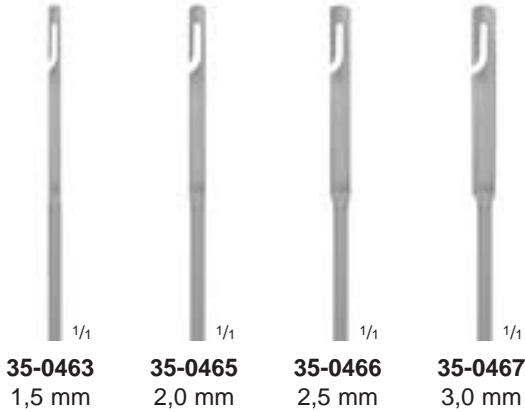

35-0463
1,5 mm

35-0465
2,0 mm

35-0466
2,5 mm

35-0467
3,0 mm

35-0463
- 35-0467

Fadenfänger allein
Suture hook, only
Porta-ligaduras, suelto
Tirette seule
Tira-filo, solo

RUMEL-BELMONT
▶ **35-0460** ø 3,2 mm
35-0462 ø 6,4 mm
33 cm, 13"

Tourniquets, flexibel
Tourniquets, flexible
Torniquetes, flexibles
Tourniquets, flexibles
Tourniquets, flessibile



KLIMA-ROSEGGER
18-0421 ø 1,2 x 35 mm
▶ **18-0420** ø 1,8 x 35 mm

Kanülen zur Sternalpunktion
Sternum puncture needles
Agujas para la punción del esternón
Aiguilles à la ponction sternale
Aghi per la puntura dello sterno



ABRAMS
39-0500
ø 4,0 x 90 mm

Kanüle zur Brustfellpunktion
Pleura puncture needle
Aguja para la punción de la pleura
Aiguille à ponction pleurale
Ago per la puntura della pleura

ATRAUMATIC-GRIP Instrumente mit atraumatischer Riefung

ATRAUMATIC-GRIP Instruments with non-traumatic serration

ATRAUMATIC-GRIP Instrumentos con bocas atraumáticas

ATRAUMATIC-GRIP Instruments avec mors atraumatiques

ATRAUMATIC-GRIP Strumenti con presa atraumatica

**LAWTON-Zahnung**

Toothing LAWTON

Dentado LAWTON

Denture LAWTON

Dentatura LAWTON

- **1 x 2 Zahnreihen**
- 1 x 2 rows of teeth
- 1 x 2 hileras de dientes
- 1 x 2 rangées de dents
- 1 x 2 File di denti

**DE BAKEY-Zahnung**

Toothing DE BAKEY

Dentado DE BAKEY

Denture DE BAKEY

Dentatura DE BAKEY

- **1 x 2 Zahnreihen**
- 1 x 2 rows of teeth
- 1 x 2 hileras de dientes
- 1 x 2 rangées de dents
- 1 x 2 File di denti

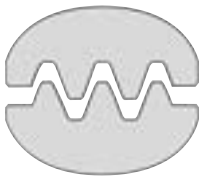
**DE BAKEY-Zahnung**

Toothing DE BAKEY

Dentado DE BAKEY

Denture DE BAKEY

Dentatura DE BAKEY

- **2 x 3 Zahnreihen**
- 2 x 3 rows of teeth
- 2 x 3 hileras de dientes
- 2 x 3 rangées de dents
- 2 x 3 File di denti

**DARDIK-Zahnung**

Toothing DARDIK

Dentado DARDIK

Denture DARDIK

Dentatura DARDIK

- **2 x 3 Zahnreihen**
- 2 x 3 rows of teeth
- 2 x 3 hileras de dientes
- 2 x 3 rangées de dents
- 2 x 3 File di denti

**COOLEY-Zahnung**

Toothing COOLEY

Dentado COOLEY

Denture COOLEY

Dentatura COOLEY

- **2 x 2 Zahnreihen**
- 2 x 2 rows of teeth
- 2 x 2 hileras de dientes
- 2 x 2 rangées de dents
- 2 x 2 File di denti



ATRAUMATIC-GRIP Gefäßklemmen
 ATRAUMATIC-GRIP Vascular Clamps
 ATRAUMATIC-GRIP Pinzas-clamps vasculares
 ATRAUMATIC-GRIP Pincas vasculaires
 ATRAUMATIC-GRIP Pinze vascolari

sehr feine Modelle für Kinderchirurgie • very delicate patterns for pediatric surgery • modelos muy delicados para la pediatría
 modèles très délicats pour chirurgie pédiatrique • modelli molto delicati per uso pediatrico

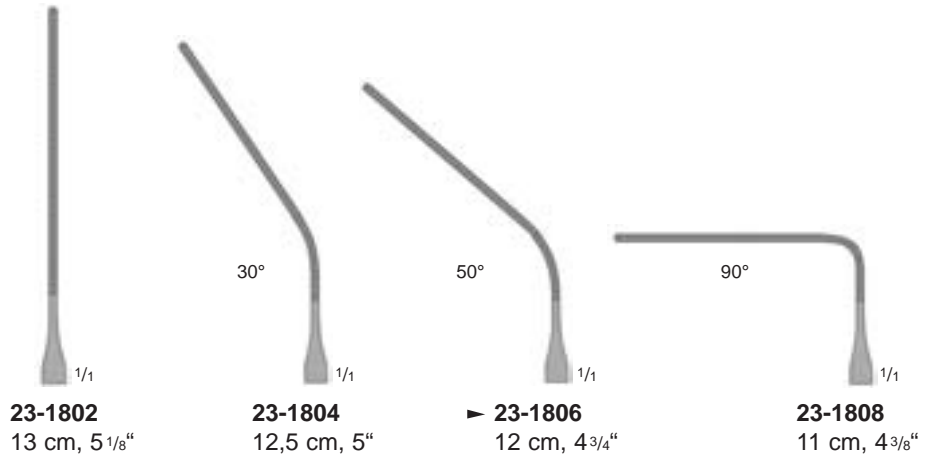

CASTANEDA
 23-1802
 - 23-1808

Mehrweckklemmen
 Multi-purpose clamps
 Pinzas-clamps de varias aplicaciones
 Pincas-clamps universelles
 Pinze multiuso

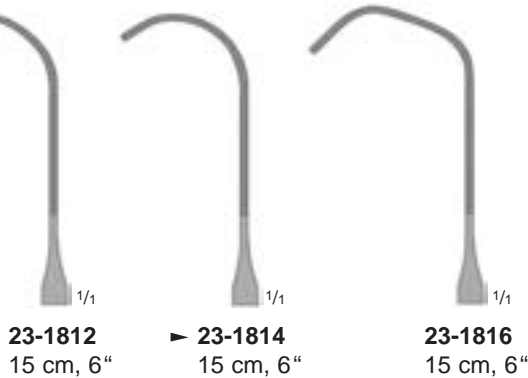

CASTANEDA
 23-1812
 - 23-1816

Anastomosenklemmen
 Anastomosis clamps
 Pinzas-clamps para anastomosis
 Pincas-clamps pour anastomose
 Pinze per anastomosi

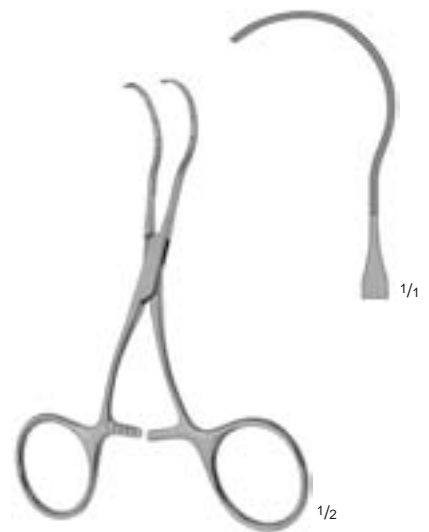

CASTANEDA
 23-1818
 12 cm, 4 3/4"

Anastomosenklemme
 Anastomosis clamp
 Pinza-clamp para anastomosis
 Pince-clamp pour anastomose
 Pinza per anastomosi

ATRAUMATIC-GRIP Gefäßklemmen mit LAWTON-Zahnung
 ATRAUMATIC-GRIP Vascular Clamps with Toothing LAWTON
 ATRAUMATIC-GRIP Pinzas-clamps vasculares con dentado LAWTON
 ATRAUMATIC-GRIP Pincas vasculaires avec denture LAWTON
 ATRAUMATIC-GRIP Pinze vascolari con dentatura LAWTON



sehr feine Modelle für Kinderchirurgie • very delicate patterns for pediatric surgery • modelos muy delicados para la pediatría
 modèles très délicats pour chirurgie pédiatrique • modelli molto delicati per uso pediatrico



23-1820
 16,5 cm, 6 1/2"

Mehrweckklemme
 Multi-purpose clamp
 Pinza-clamp de varias aplicaciones
 Pince-clamp universelles
 Pinza multiuso

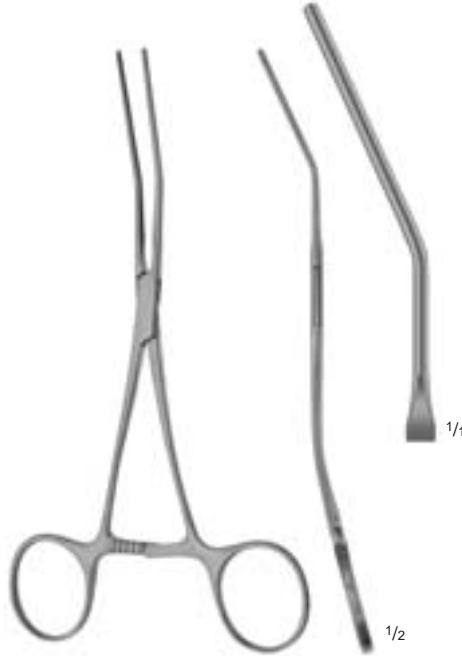

23-1810
 16 cm, 6 1/4"

Mehrweckklemme
 Multi-purpose clamp
 Pinza-clamp de varias aplicaciones
 Pince-clamp universelles
 Pinza multiuso

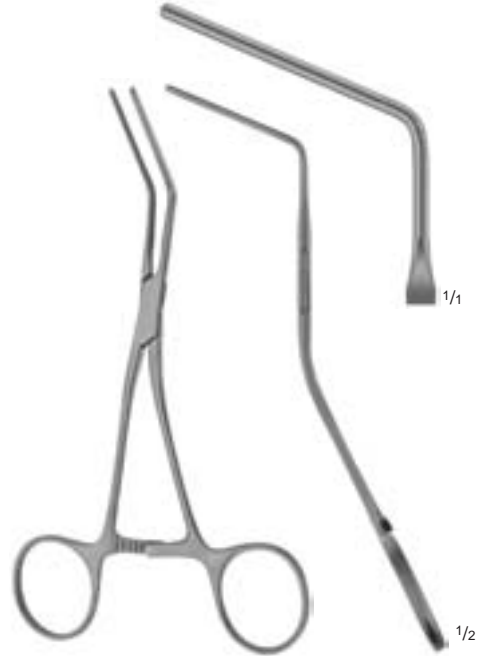

23-1800
 15 cm, 6"

Mehrweckklemme
 Multi-purpose clamp
 Pinza-clamp de varias aplicaciones
 Pince-clamp universelles
 Pinza multiuso

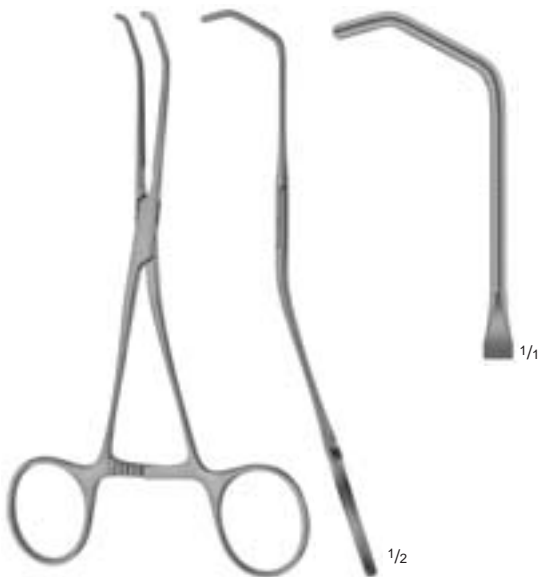

23-1830
 15 cm, 6"

Anastomosenklemme
 Anastomosis clamp
 Pinza-clamp para anastomosis
 Pince-clamp pour anastomose
 Pinza per anastomosi

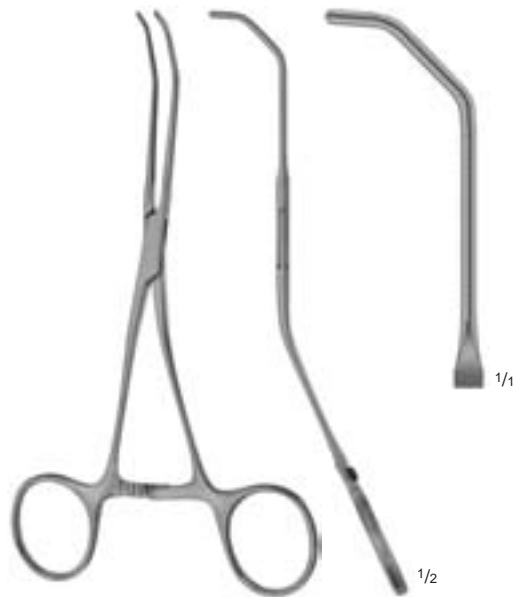

23-1840
 15,5 cm, 6"

Anastomosenklemme
 Anastomosis clamp
 Pinza-clamp para anastomosis
 Pince-clamp pour anastomose
 Pinza per anastomosi



ATRAUMATIC-GRIP Gefäßklemmen mit LAWTON-Zahnung
 ATRAUMATIC-GRIP Vascular Clamps with Toothing LAWTON
 ATRAUMATIC-GRIP Pinzas-clamps vasculares con dentado LAWTON
 ATRAUMATIC-GRIP Pincas vasculaires avec denture LAWTON
 ATRAUMATIC-GRIP Pinze vascolari con dentatura LAWTON



sehr feine Modelle für Kinderchirurgie • very delicate patterns for pediatric surgery • modelos muy delicados para la pediatría
 modèles très délicats pour chirurgie pédiatrique • modelli molto delicati per uso pediatrico



23-1860
23-1870



23-1861
23-1871



23-1862
23-1872



23-1863
23-1873



23-1864
23-1874

Mehrzweckklemmen • Multi-purpose clamps • Pinzas-clamps de varias aplicaciones • Pincas-clamps universelles • Pinze multiuso



▶ 23-1865
▶ 23-1875



23-1866
23-1876



23-1868
23-1878



23-1867
23-1877

Anastomosenklemmen • Anastomosis clamps • Pinzas-clamps para anastomosis • Pincas-clamps pour anastomose • Pinze per anastomosi

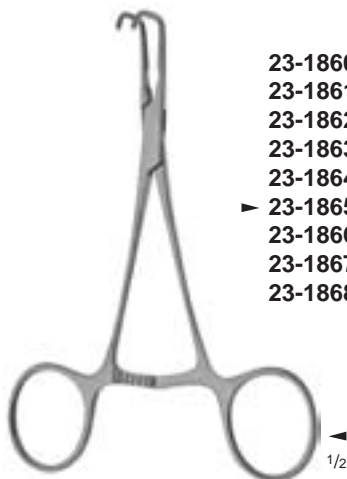

23-1860 14,0 cm, 5 1/2"
 23-1861 14,0 cm, 5 1/2"
 23-1862 13,5 cm, 5 1/4"
 23-1863 13,0 cm, 5 1/8"
 23-1864 14,0 cm, 5 1/2"
 ▶ 23-1865 12,5 cm, 5"
 23-1866 12,5 cm, 5"
 23-1867 13,5 cm, 5 1/4"
 23-1868 13,0 cm, 5 1/8"

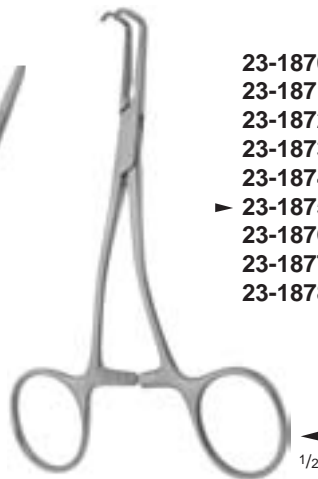

23-1870 13,5 cm, 5 1/4"
 23-1871 13,5 cm, 5 1/4"
 23-1872 13,0 cm, 5 1/8"
 23-1873 12,5 cm, 5"
 23-1874 13,5 cm, 5 1/4"
 ▶ 23-1875 12,0 cm, 4 3/4"
 23-1876 12,0 cm, 4 3/4"
 23-1877 13,0 cm, 5 1/8"
 23-1878 12,5 cm, 5"

ATRAUMATIC-GRIP Gefäßklemmen mit LAWTON-Zahnung
 ATRAUMATIC-GRIP Vascular Clamps with Toothing LAWTON
 ATRAUMATIC-GRIP Pinzas-clamps vasculares con dentado LAWTON
 ATRAUMATIC-GRIP Pincas vasculaires avec denture LAWTON
 ATRAUMATIC-GRIP Pinze vascolari con dentatura LAWTON



sehr feine Modelle für Kinderchirurgie • very delicate patterns for pediatric surgery • modelos muy delicados para la pediatría
 modèles très délicats pour chirurgie pédiatrique • modelli molto delicati per uso pediatrico



23-1880
23-1890



23-1881
23-1891



23-1882
23-1892



23-1883
23-1893



23-1884
23-1894

Mehrweckklemmen • Multi-purpose clamps • Pinzas-clamps de varias aplicaciones • Pincas-clamps universelles • Pinze multiuso



► 23-1885
► 23-1895



23-1886
23-1896



23-1888
23-1898



23-1887
23-1897

Anastomosenklemmen • Anastomosis clamps • Pinzas-clamps para anastomosis • Pincas-clamps pour anastomose • Pinze per anastomosi

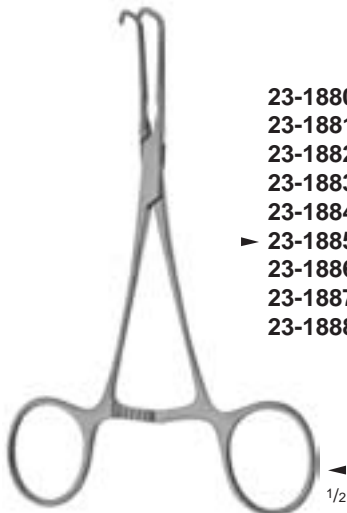

23-1880 15,0 cm, 6"
 23-1881 15,0 cm, 6"
 23-1882 14,5 cm, 5³/₄"
 23-1883 13,5 cm, 5¹/₄"
 23-1884 14,5 cm, 5³/₄"
 ► 23-1885 13,5 cm, 5¹/₄"
 23-1886 13,5 cm, 5¹/₄"
 23-1887 14,5 cm, 5³/₄"
 23-1888 14,0 cm, 5¹/₂"

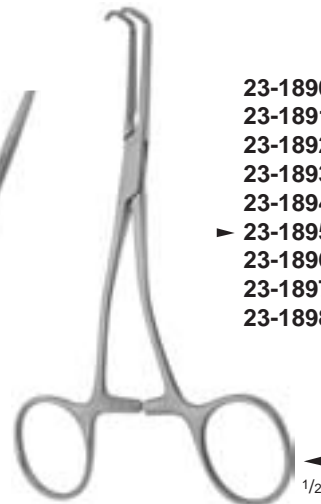

23-1890 14,5 cm, 5³/₄"
 23-1891 14,5 cm, 5³/₄"
 23-1892 14,0 cm, 5¹/₂"
 23-1893 13,0 cm, 5¹/₈"
 23-1894 14,0 cm, 5¹/₂"
 ► 23-1895 13,0 cm, 5¹/₈"
 23-1896 13,0 cm, 5¹/₈"
 23-1897 14,0 cm, 5¹/₂"
 23-1898 13,5 cm, 5¹/₄"



ATRAUMATIC-GRIP Karotis-Klemmen mit LAWTON-Zahnung
 ATRAUMATIC-GRIP Carotid Clamps with Toothing LAWTON
 ATRAUMATIC-GRIP Pinzas-clamps para carótida con dentado LAWTON
 ATRAUMATIC-GRIP Pincas-clamps pour la carotide avec denture LAWTON
 ATRAUMATIC-GRIP Pinze per la carotide con dentatura LAWTON

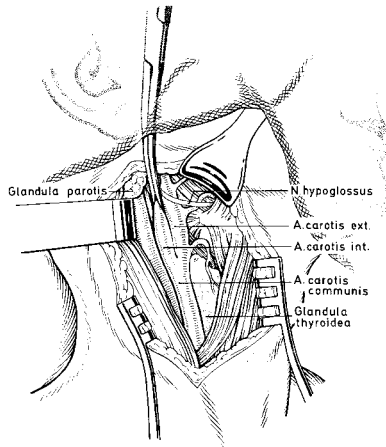

Der Einsatz der Spezialklemme nach DEVIN in der Karotis-Chirurgie ist sehr vorteilhaft, da das Instrument nicht in das Operationsfeld hineinragt und bei der Arteriotomie ein freies Gesichtsfeld gewährleistet ist.

The special DEVIN clamp offers numerous advantages for carotid surgery. Its use ensures that the area in which the arteriotomy is performed is not obstructed by any instrument in front of or behind the operating area.

La utilización de la pinza especial DEVIN en la cirugía de la carótida ofrece grandes ventajas; de este modo no hay ningún instrumento que cruce (tanto adelante que atrás) la región de la arteriotomía.

L'utilisation du clamp spécial de DEVIN est très avantageuse pour la chirurgie carotidienne, car ainsi il n'y a pas d'instrument qui croise (par devant ou par derrière) la région de l'artériotomie.

La pinza DEVIN offre numerosi vantaggi nella chirurgia della carotide. Il suo impiego assicura che nell'area ove viene eseguita l'arteriotomia il campo non sia ostruito (davanti e dietro).



sehr fein
 very delicate
 muy delicada
 très délicat
 molto delicata

DEVIN
 23-1850
 19 cm, 7 1/2"



sehr fein
 very delicate
 muy delicada
 très délicat
 molto delicata

DEVIN
 23-1852
 17,5 cm, 7"

ATRAUMATIC-GRIP Bulldogklemmen mit DE BAKEY-Zahnung

ATRAUMATIC-GRIP Bulldog Clamps with Toothing DE BAKEY

ATRAUMATIC-GRIP Clamps Bulldog con dentado DE BAKEY

ATRAUMATIC-GRIP Clamps Bulldog avec denture DE BAKEY

ATRAUMATIC-GRIP Pinze Bulldog con dentatura DE BAKEY



Schließdruck einstellbar
occlusion pressure adjustable
presión de oclusión ajustable
pression d'occlusion ajustable
pressione occlusiva regolabile



1/2

▶ **30-1000**
8 cm
3 1/8"



1/1

30-1005
9 cm
3 1/2"



1/1

30-1010
10,5 cm
4 1/8"



1/1

30-1015
12 cm
4 3/4"



1/1

30-1001
7,5 cm
3"



1/1

30-1006
8,5 cm
3 3/8"



1/1

30-1011
10 cm
4"



1/1

30-1016
11,5 cm
4 1/2"



1/1

GLOVER-
DE BAKEY
30-1000
- **30-1016**



1/1



1/2

GLOVER-
DE BAKEY
30-1026
5 cm, 2"



1/1



1/2

SATINSKY-
DE BAKEY
30-1027
7 cm, 2 3/4"



1/1



1/2

CAROTIS-
DE BAKEY
30-1030
9 cm, 3 1/2"



1/1



1/2

SATINSKY-
DE BAKEY
30-1025
10 cm, 4"



ATRAUMATIC-GRIP Bulldogklemmen mit DE BAKEY-Zahnung

ATRAUMATIC-GRIP Bulldog Clamps with Toothing DE BAKEY

ATRAUMATIC-GRIP Clamps Bulldog con dentado DE BAKEY

ATRAUMATIC-GRIP Clamps Bulldog avec denture DE BAKEY

ATRAUMATIC-GRIP Pinze Bulldog con dentatura DE BAKEY

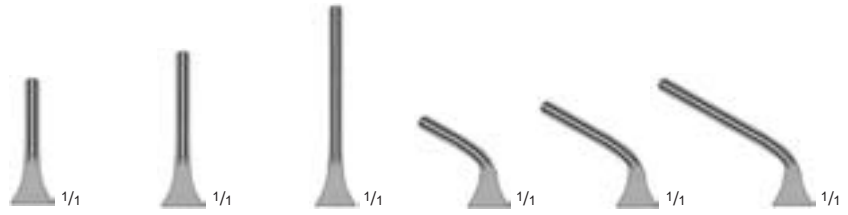

| Kat. Nr. Cat. ref. Núm. de cat. No. de cat. No di cat. | 06-0082 | 06-0083 | ▶ 06-0084 | 06-0085 | 06-0086 | 06-0087 |
|---|--------------|--------------|--------------|--------------|--------------|--------------|
| Länge Length Longitud Longeur Lungh. | 49 mm | 53 mm | 59 mm | 44 mm | 46 mm | 49 mm |
| Maullänge Length of jaw Longitud de boca Longueur des mors Lungh. dei morsi | 10 mm | 14 mm | 20 mm | 10 mm | 14 mm | 20 mm |
| Schließdruck Occlusion pressure Presión de oclusión Pression d'occlusion Pressione occlusiva | 180 ± 10 gr. | 180 ± 10 gr. | 180 ± 10 gr. | 180 ± 10 gr. | 180 ± 10 gr. | 180 ± 10 gr. |
| Gewicht Weight Peso Poids Peso | 3 gr. | 3 gr. | 3 gr. | 3 gr. | 3 gr. | 3 gr. |



DIETRICH-
DE BAKEY
06-0082
- 06-0087

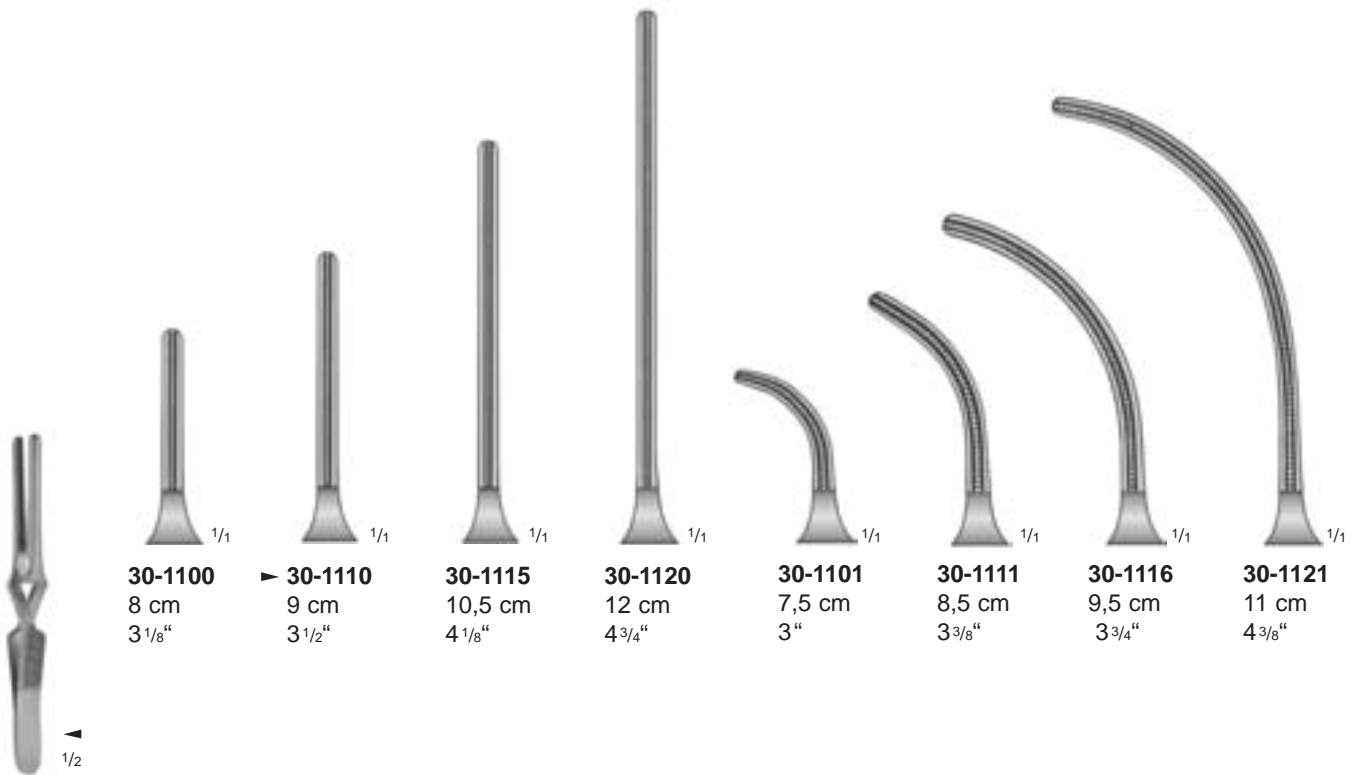

30-1100
8 cm
3 1/8"

▶ **30-1110**
9 cm
3 1/2"

30-1115
10,5 cm
4 1/8"

30-1120
12 cm
4 3/4"

30-1101
7,5 cm
3"

30-1111
8,5 cm
3 3/8"

30-1116
9,5 cm
3 3/4"

30-1121
11 cm
4 3/8"



DE BAKEY
30-1100
- 30-1121

ATRAUMATIC-GRIP Bulldogklemmen mit DE BAKEY-Zahnung

ATRAUMATIC-GRIP Bulldog Clamps with Toothing DE BAKEY

ATRAUMATIC-GRIP Clamps Bulldog con dentado DE BAKEY

ATRAUMATIC-GRIP Clamps Bulldog avec denture DE BAKEY

ATRAUMATIC-GRIP Pinze Bulldog con detatura DE BAKEY



1/2



1/1

30-1124
9 cm, 3 1/2"



1/1

30-1125
11 cm, 4 3/8"

GREGORY-SOFT

30-1124

- **30-1125**

Karotisklemmen

Carotid clamps

Pinzas-clamps para carótis

Pinces-clamps pour la carotide

Pinze per la carotide



1/1

30-1127
11 cm, 4 3/8"

links
left
izquierda
gauche
sinistra



1/1

30-1128
11 cm, 4 3/8"

rechts
right
derecha
droite
destra



1/2

GREGORY-SOFT

30-1127

- **30-1128**

Karotisklemmen

Carotid clamps

Pinzas-clamps para carótis

Pinces-clamps pour la carotide

Pinze per la carotide



1/2

JOHNS-HOPKINS

06-0035

24,5 cm, 9 3/4"

Anlege- und Entfernungszange für Bulldogklemmen 06-0082 - 06-0087 und 30-1100 - 30-1121

Applying and removing forceps for Bulldog clamps 06-0082 - 06-0087 and 30-1100 - 30-1121

Pinza para poner y quitar clamps Bulldog 06-0082 - 06-0087 y 30-1100 - 30-1121

Pince pour poser et retirer les clamps Bulldog 06-0082 - 06-0087 et 30-1100 - 30-1121

Pinza per applicare e rimuovere clamps 06-0082 - 06-0087 e 30-1100 - 30-1121



ATRAUMATIC-GRIP Bulldogklemmen mit DE BAKEY-Zahnung

ATRAUMATIC-GRIP Bulldog Clamps with Toothing DE BAKEY

ATRAUMATIC-GRIP Clamps Bulldog con dentado DE BAKEY

ATRAUMATIC-GRIP Clamps Bulldog avec denture DE BAKEY

ATRAUMATIC-GRIP Pinze Bulldog con dentatura DE BAKEY



DE BAKEY
30-1130
13 cm, 5 1/8"

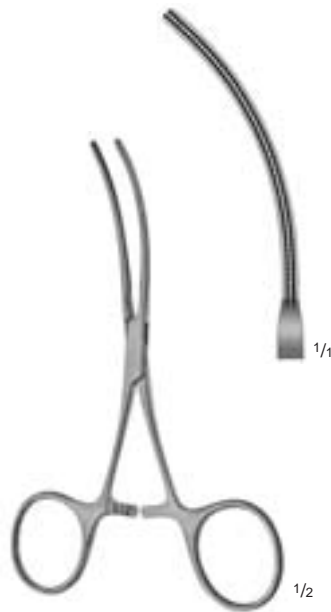

DE BAKEY
30-1132
12,5 cm, 5"



DE BAKEY
30-1136
10 cm, 4"



DE BAKEY
30-1138
12,5 cm, 5"

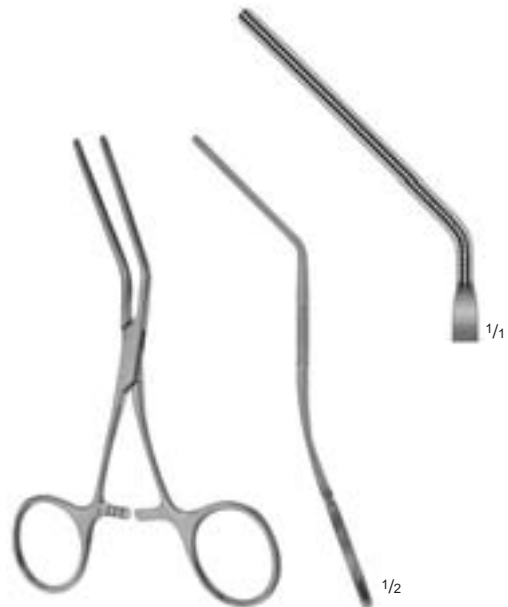

DE BAKEY
30-1134
12,5 cm, 5"

ATRAUMATIC-GRIP Gefäßklemmen mit DE BAKEY-Zahnung
 ATRAUMATIC-GRIP Vascular Clamps with Toothing DE BAKEY
 ATRAUMATIC-GRIP Pinzas-clamps vasculares con dentado DE BAKEY
 ATRAUMATIC-GRIP Pinces vasculaires avec denture DE BAKEY
 ATRAUMATIC-GRIP Pinze vascolari con dentatura DE BAKEY



DE BAKEY-PEAN
06-0423
 - **06-0436**

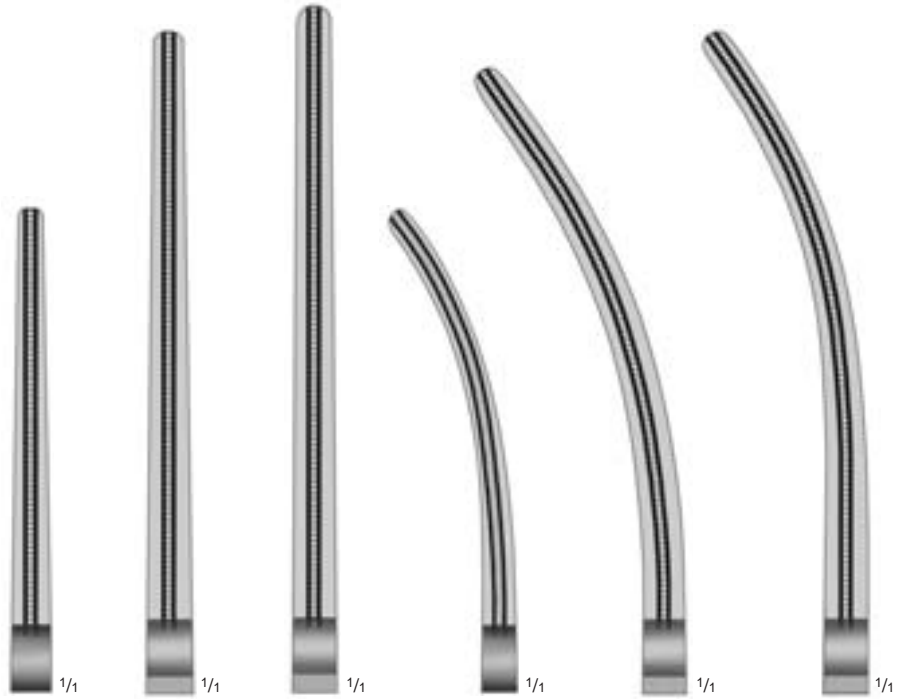

| | | | | | |
|---------------------------------|--------------------------------------|--------------------------------|-------------------------------|--------------------------------------|--------------------------------|
| ▶ 06-0423 20 cm 8" | 06-0433 26,5 cm 10 1/2" | 06-0434 28 cm 11" | 06-0428 20 cm 8" | 06-0435 26,5 cm 10 1/2" | 06-0436 28 cm 11" |
|---------------------------------|--------------------------------------|--------------------------------|-------------------------------|--------------------------------------|--------------------------------|



DE BAKEY
30-1160
 - **30-1167**

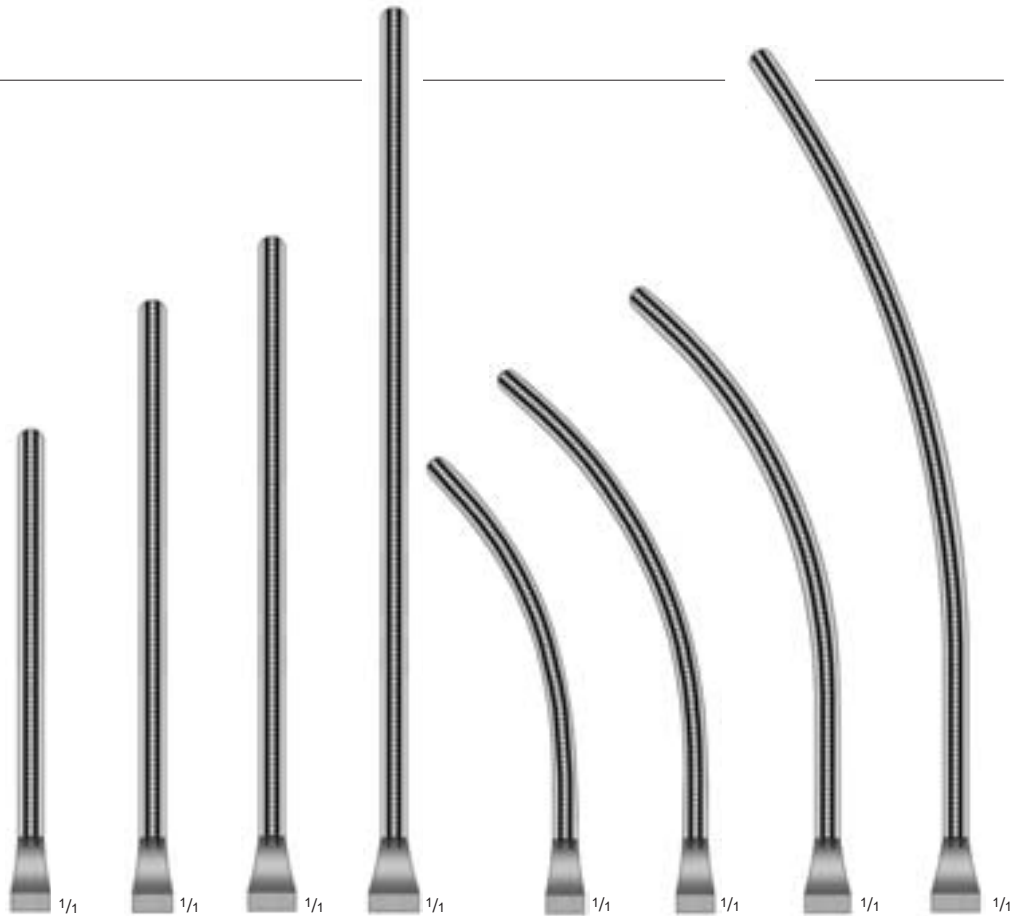

| | | | | | | | |
|---------------------------------------|-------------------------------|------------------------------------|------------------------------------|-------------------------------------|-------------------------------|------------------------------------|------------------------------------|
| ▶ 30-1160 21,5 cm 8 1/2" | 30-1162 23 cm 9" | 30-1164 27 cm 10 3/4" | 30-1166 31 cm 12 1/4" | 30-1161 21,5 cm 8 1/2" | 30-1163 23 cm 9" | 30-1165 27 cm 10 3/4" | 30-1167 31 cm 12 1/4" |
|---------------------------------------|-------------------------------|------------------------------------|------------------------------------|-------------------------------------|-------------------------------|------------------------------------|------------------------------------|



ATRAUMATIC-GRIP Gefäßklemmen mit DE BAKEY-Zahnung
 ATRAUMATIC-GRIP Vascular Clamps with Toothing DE BAKEY
 ATRAUMATIC-GRIP Pinzas-clamps vasculares con dentado DE BAKEY
 ATRAUMATIC-GRIP Pinces vasculaires avec denture DE BAKEY
 ATRAUMATIC-GRIP Pinze vascolari con dentatura DE BAKEY

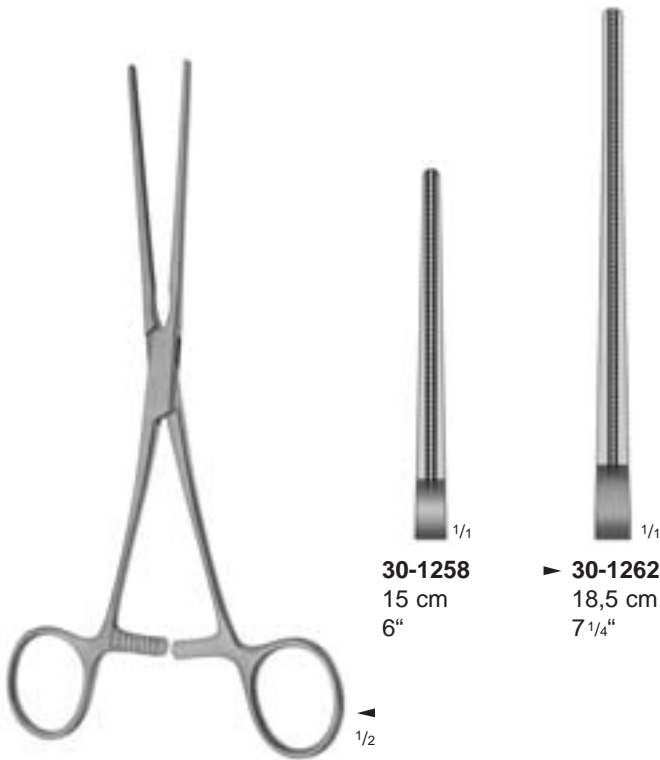

30-1258
15 cm
6"

▶ **30-1262**
18,5 cm
7 1/4"

30-1263
15 cm
6"

▶ **30-1267**
18,5 cm
7 1/4"

DE BAKEY-BAINBRIDGE
30-1258
- 30-1262

DE BAKEY-BAINBRIDGE
30-1263
- 30-1267



23-2535
16 cm, 6 1/4"

▶ **23-2537**
15,5 cm, 6"

23-2539
14 cm, 5 1/2"

Mehrzweckklemmen • Multi-purpose clamps • Pinzas-clamps de varias aplicaciones
 Pinces-clamps universelles • Pinze multiuso

DE BAKEY
23-2535
- 23-2539

ATRAUMATIC-GRIP Patent-Ductusklemmen mit DE BAKEY-Zahnung

ATRAUMATIC-GRIP Patent Ductus Clamps with Toothing DE BAKEY

ATRAUMATIC-GRIP Pinzas patente de conducto con dentado DE BAKEY

ATRAUMATIC-GRIP Clamps patent-ductus avec denture DE BAKEY

ATRAUMATIC-GRIP Pinze esclusive per dotto con dentatura DE BAKEY

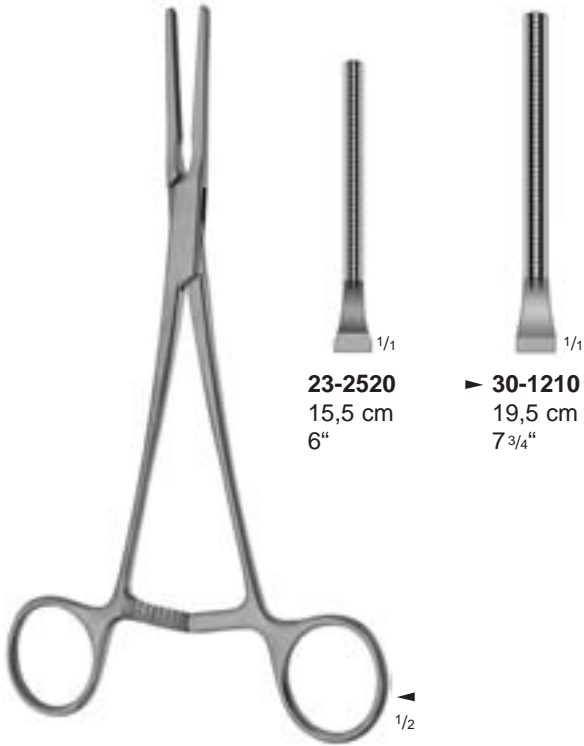

23-2520
15,5 cm
6"

▶ **30-1210**
19,5 cm
7 3/4"

DE BAKEY
23-2520
- **30-1210**

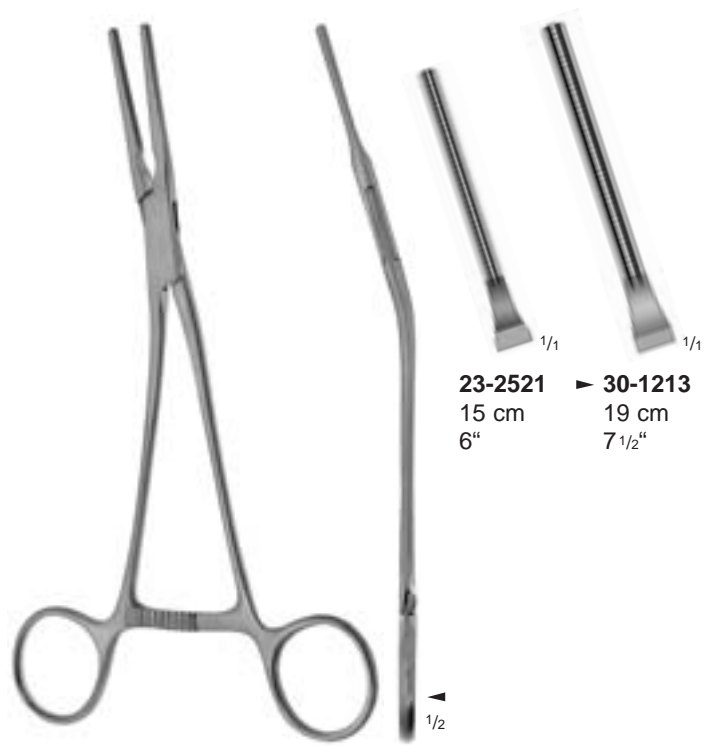

23-2521
15 cm
6"

▶ **30-1213**
19 cm
7 1/2"

DE BAKEY
23-2521
- **30-1213**



DE BAKEY-POTTS
30-1910
20,5 cm, 8"



DE BAKEY-POTTS
30-1911
20 cm, 8"



ATRAUMATIC-GRIP Coarctationsklemmen mit DE BAKEY-Zahnung
ATRAUMATIC-GRIP Coarctation Clamps with Toothing DE BAKEY
ATRAUMATIC-GRIP Pinzas-clamps para coarctación con dentado DE BAKEY
ATRAUMATIC-GRIP Pincers-clamps pour coarctation avec denture DE BAKEY
ATRAUMATIC-GRIP Pinze per coartazione con dentatura DE BAKEY



DE BAKEY
23-2522
16,5 cm, 6 1/2"



DE BAKEY
23-2523
16 cm, 6 1/4"



DE BAKEY
23-2555
17 cm, 6 3/4"



DE BAKEY
23-2524
17 cm, 6 3/4"

ATRAUMATIC-GRIP Coarctationsklemmen mit DE BAKEY-Zahnung

ATRAUMATIC-GRIP Coarctation Clamps with Toothing DE BAKEY

ATRAUMATIC-GRIP Pinzas-clamps para coarctación con dentado DE BAKEY

ATRAUMATIC-GRIP Pincès-clamps pour coarctation avec denture DE BAKEY

ATRAUMATIC-GRIP Pinze per coartazione con dentatura DE BAKEY



30-1915
20,5 cm, 8"



▶ **30-1200**
22,5 cm, 9"



30-1917
26 cm, 10 1/4"

DE BAKEY
30-1200
- **30-1917**

1/2



30-1916
20 cm, 8"



▶ **30-1203**
22 cm, 8 3/4"



30-1918
25,5 cm, 10"

DE BAKEY
30-1203
- **30-1918**

1/2



ATRAUMATIC-GRIP Gefäßklemmen mit DE BAKEY-Zahnung
 ATRAUMATIC-GRIP Vascular Clamps with Toothing DE BAKEY
 ATRAUMATIC-GRIP Pinzas-clamps vasculares con dentado DE BAKEY
 ATRAUMATIC-GRIP Pincas vasculaires avec denture DE BAKEY
 ATRAUMATIC-GRIP Pinze vascolari con dentatura DE BAKEY



GREGORY
30-1150
 - **30-1154**



30-1150
 14 cm, 5 1/2"



30-1152
 16 cm, 6 1/4"



30-1154
 18 cm, 7"

Profundaklemmen • Profunda clamps • Pinzas-clamps para la profunda • Pincas-clamps pour fémorale • Pinze per profunda



LELAND-JONES
30-1291
 - **30-1292**



30-1291
 19 cm, 7 1/2"



30-1292
 18,5 cm, 7 1/4"



DE BAKEY
30-1235
 18 cm, 7"

Peripheralklemmen • Peripheral vascular clamps • Pinzas-clamps para vasos periféricos • Pincas-clamps vasculaires périphériques • Pinze per vasi periferici

ATRAUMATIC-GRIP Peripheralklemmen mit DE BAKEY-Zahnung

ATRAUMATIC-GRIP Peripheral Vascular Clamps with Toothing DE BAKEY

ATRAUMATIC-GRIP Pinzas-clamps para vasos periféricos

ATRAUMATIC-GRIP Pincas-clamps vasculaires périphériques avec denture DE BAKEY

ATRAUMATIC-GRIP Pinze per vasi periferici con dentatura DE BAKEY



DE BAKEY
30-1250
15,5 cm, 6"



DE BAKEY
30-1240
- 30-1245

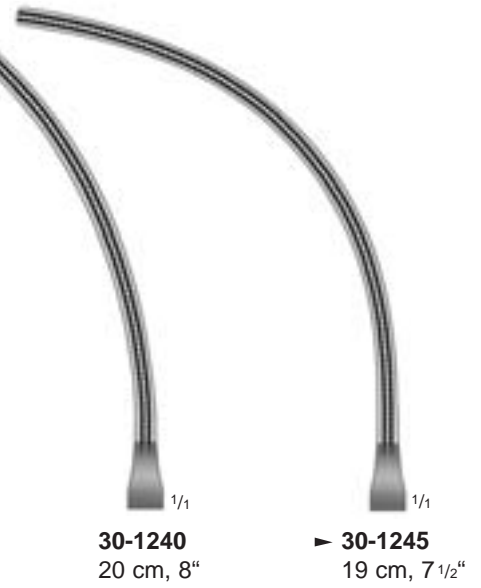

30-1240
20 cm, 8"

▶ 30-1245
19 cm, 7 1/2"



DALE
30-1270
- 30-1276

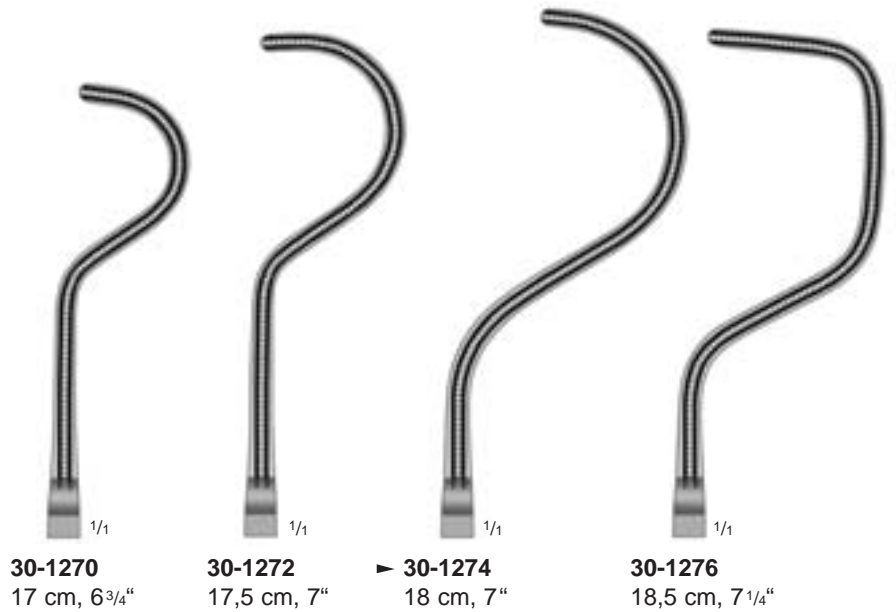

30-1270
17 cm, 6 3/4"

30-1272
17,5 cm, 7"

▶ 30-1274
18 cm, 7"

30-1276
18,5 cm, 7 1/4"



ATRAUMATIC-GRIP Peripheralklemmen mit DE BAKEY-Zahnung

ATRAUMATIC-GRIP Peripheral Vascular Clamps with Toothing DE BAKEY

ATRAUMATIC-GRIP Pinzas-clamps para vasos periféricos

ATRAUMATIC-GRIP Pincas-clamps vasculaires périphériques avec denture DE BAKEY

ATRAUMATIC-GRIP Pinze per vasi periferici con dentatura DE BAKEY



DE BAKEY
30-1280
15 cm, 6"



DE BAKEY
30-1282
16,5 cm, 6 1/2"

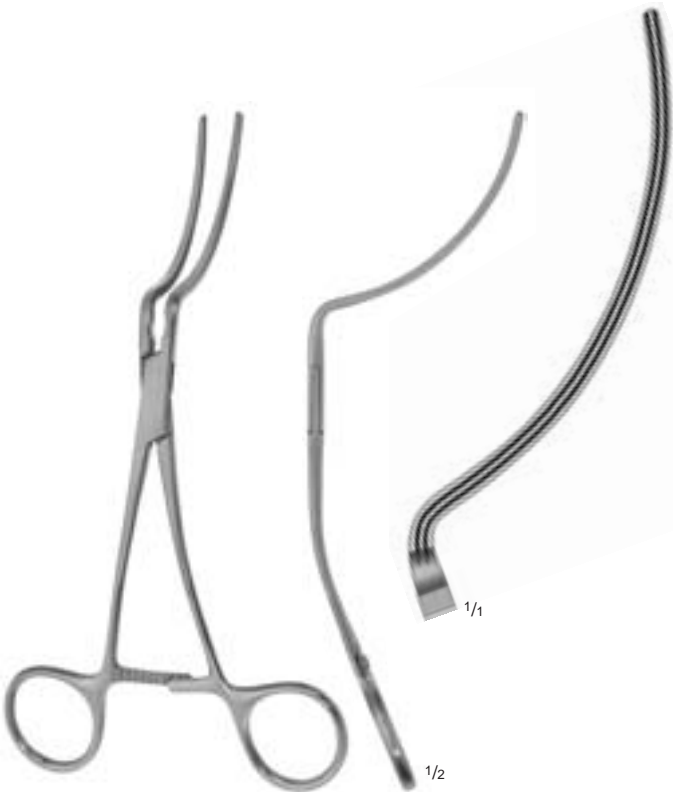

DE BAKEY
30-1284
18 cm, 7"



DE BAKEY
30-1286
19 cm, 7 1/2"

ATRAUMATIC-GRIP Gefäßklemmen mit DE BAKEY-Zahnung
ATRAUMATIC-GRIP Vascular Clamps with Toothing DE BAKEY
ATRAUMATIC-GRIP Pinzas-clamps vasculares con dentado DE BAKEY
ATRAUMATIC-GRIP Pincas vasculaires avec denture DE BAKEY
ATRAUMATIC-GRIP Pinze vascolari con dentatura DE BAKEY



DE BAKEY
30-1156
 20 cm, 8"
Nierenarterienklemme
 Renal artery clamp
 Pinza-clamp para arteria renal
 Pince hémostatique rénale
 Pinza emostatica per arteria renale



JAVID
30-1146
 18 cm, 7"
Karotisklemme
 Carotid clamp
 Pinza-clamp para carótida
 Pince-clamp pour la carotide
 Pinza per carotide

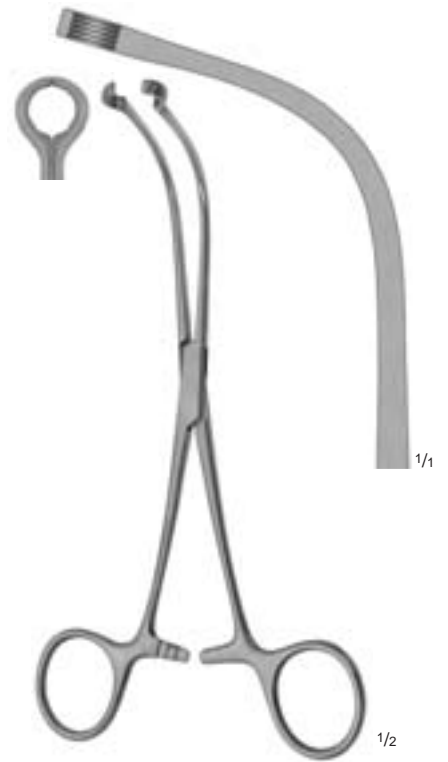

JAVID
30-1148
 19 cm, 7 1/4"
Karotisklemme
 Carotid clamp
 Pinza-clamp para carótida
 Pince-clamp pour la carotide
 Pinza per carotide



SUBRAMANIAN
23-2037
 15,5 cm, 6"



SUBRAMANIAN
23-2038
 15,5 cm, 6"



DE BAKEY-BECK
23-2550
 16 cm, 6 1/4"

Aortaklemmen • Aortic Clamps • Pinzas-clamps para aorta • Pincas-clamps pour aorte • Pinze per aorta



ATRAUMATIC-GRIP Aortaklemmen mit DE BAKEY-Zahnung

ATRAUMATIC-GRIP Aortic Clamps with Toothing DE BAKEY

ATRAUMATIC-GRIP Pinzas-clamps para aorta con dentado DE BAKEY

ATRAUMATIC-GRIP Pincas-clamps pour aorte avec denture DE BAKEY

ATRAUMATIC-GRIP Pinze per aorta con dentatura DE BAKEY

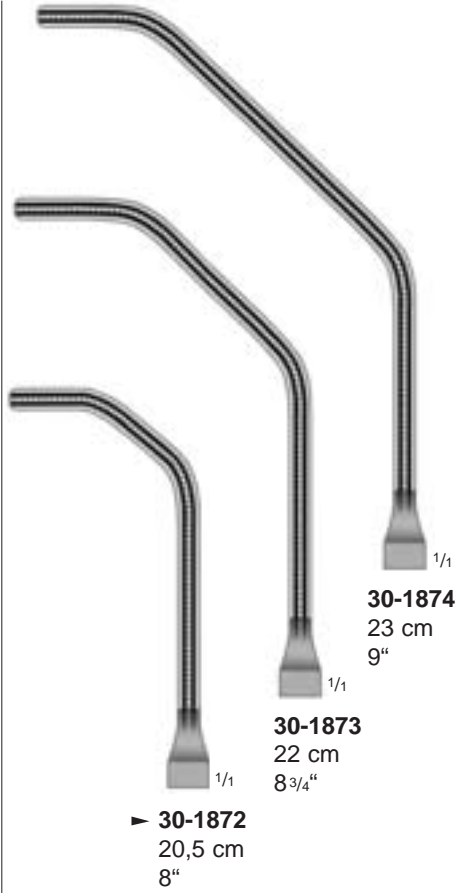

BAILEY
30-1870
- 30-1871



BAILEY
30-1872
- 30-1874



BAILEY
30-1875
- 30-1877

ATRAUMATIC-GRIP Aortaklemmen mit DE BAKEY-Zahnung
 ATRAUMATIC-GRIP Aortic Clamps with Toothing DE BAKEY
 ATRAUMATIC-GRIP Pinzas-clamps para aorta con dentado DE BAKEY
 ATRAUMATIC-GRIP Pincas-clamps pour aorte avec denture DE BAKEY
 ATRAUMATIC-GRIP Pinze per aorta con dentatura DE BAKEY



1/1



1/1



1/1



1/2

DIETRICH
30-1646
 19,5 cm, 7 3/4"



1/2

OCHSNER
30-1648
 24 cm, 9 1/2"



1/2

DE BAKEY
30-1650
 26 cm, 10 1/4"



ATRAUMATIC-GRIP Aortaklemmen mit DE BAKEY-Zahnung
ATRAUMATIC-GRIP Aortic Clamps with Toothing DE BAKEY
ATRAUMATIC-GRIP Pinzas-clamps para aorta con dentado DE BAKEY
ATRAUMATIC-GRIP Pincas-clamps pour aorte avec denture DE BAKEY
ATRAUMATIC-GRIP Pinze per aorta con dentatura DE BAKEY



▶ **30-1700**
22,5 cm, 9"



▶ **30-1704**
27,5 cm, 10³/₄"



30-1702
18 cm, 7"



30-1706
23 cm, 9"



DE BAKEY-MORRIS
30-1700
- **30-1702**



DE BAKEY-MORRIS
30-1704
- **30-1706**

ATRAUMATIC-GRIP Gefäßklemmen für Tangential-Verschluss
 ATRAUMATIC-GRIP Tangential Occlusion Clamps
 ATRAUMATIC-GRIP Pinzas-clamps para oclusión tangencial
 ATRAUMATIC-GRIP Pincés vasculaires pour occlusion tangentielle
 ATRAUMATIC-GRIP Pinze vascolari per occlusione tangenziale

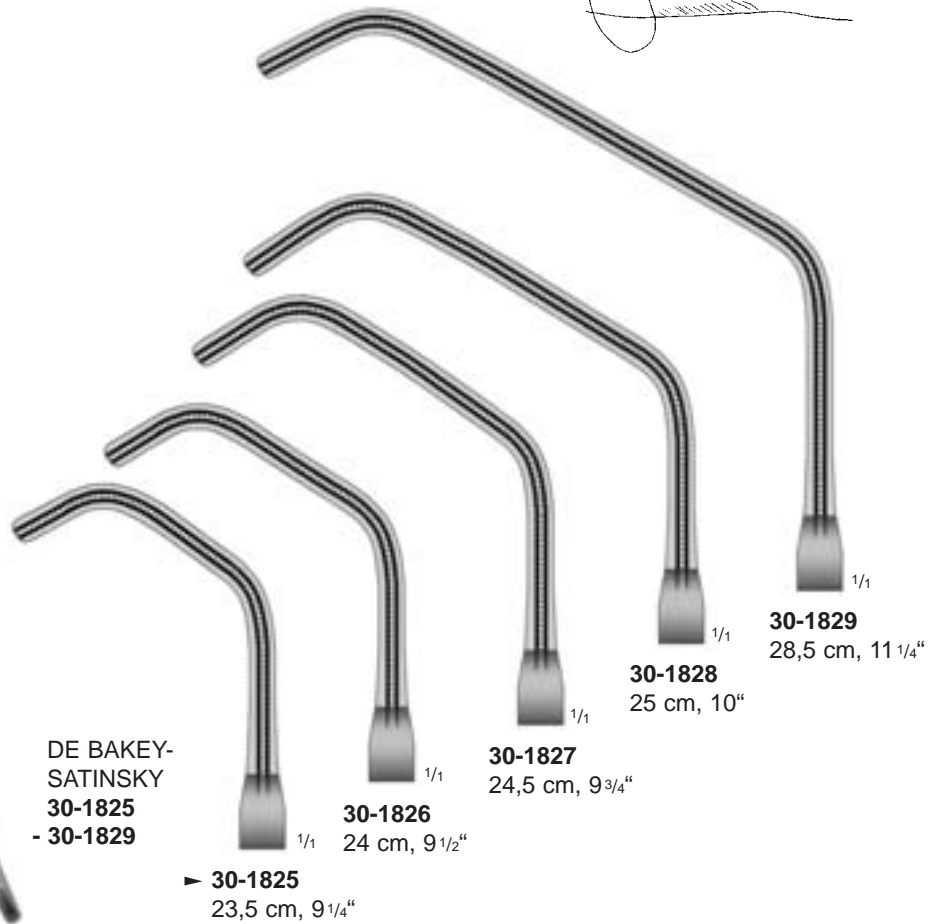
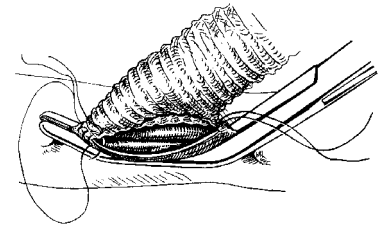
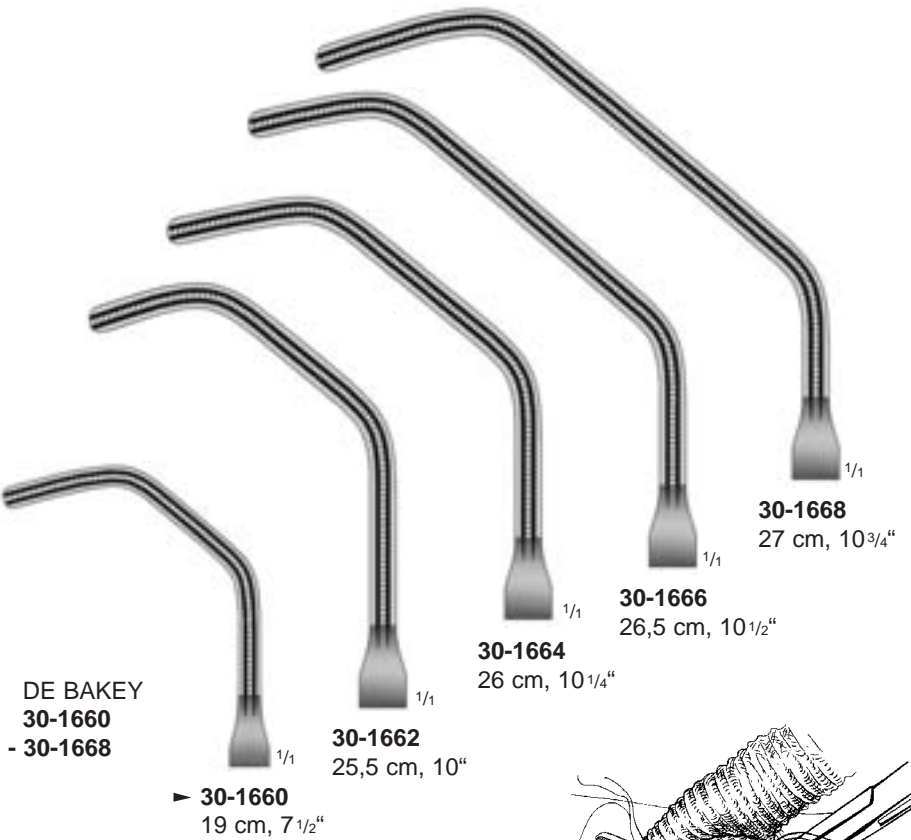



ATRAUMATIC-GRIP Anastomosenklemmen mit DE BAKEY-Zahnung
ATRAUMATIC-GRIP Anastomosis Clamps with Toothing DE BAKEY
ATRAUMATIC-GRIP Pinzas-clamps para anastomosis con dentado DE BAKEY
ATRAUMATIC-GRIP Pinces-clamps à anastomose avec denture DE BAKEY
ATRAUMATIC-GRIP Pinze per anastomosi con dentatura DE BAKEY



DE BAKEY-REYNOLDS
23-2580
- 23-2586

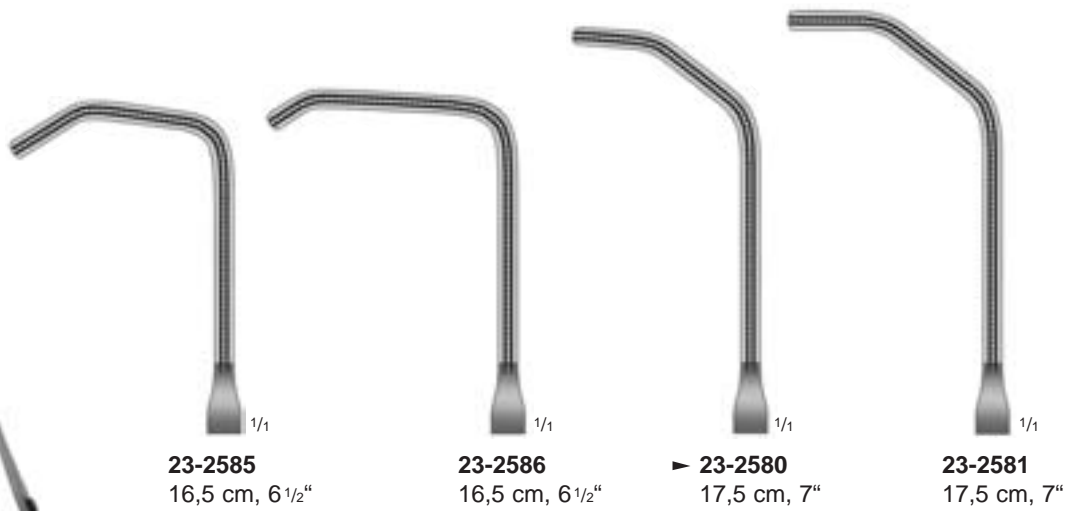

DE BAKEY-DERRA
23-2565
- 23-2567

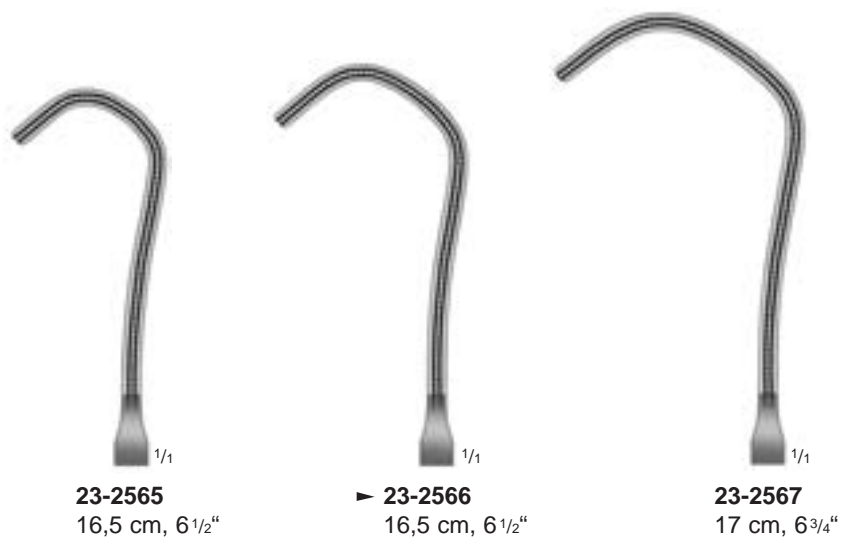

ATRAUMATIC-GRIP Anastomosenklemmen mit DE BAKEY-Zahnung
 ATRAUMATIC-GRIP Anastomosis Clamps with Toothing DE BAKEY
 ATRAUMATIC-GRIP Pinzas-clamps para anastomosis con dentado DE BAKEY
 ATRAUMATIC-GRIP Pincers-clamps à anastomose avec denture DE BAKEY
 ATRAUMATIC-GRIP Pinze per anastomosi con dentatura DE BAKEY

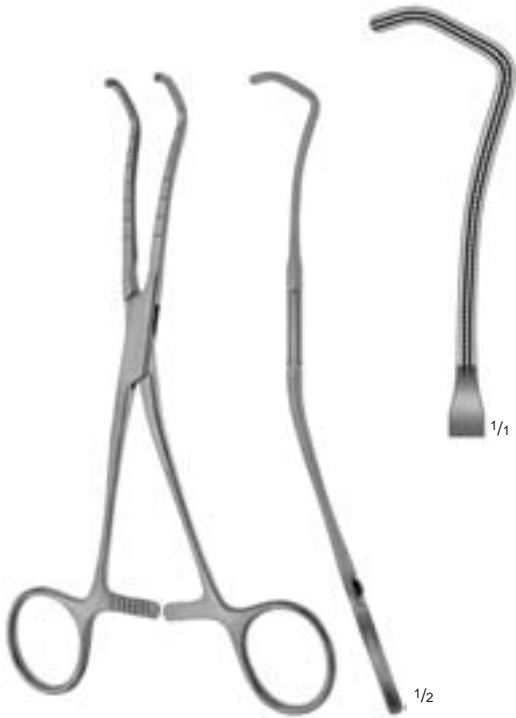

DE BAKEY
23-2593
 17 cm, 6³/₄"



DE BAKEY-BECK
23-2590
 - **23-2591**

23-2590
 15 cm, 6"

▶ **23-2591**
 15 cm, 6"



DE BAKEY
23-2528
 - **23-2530**

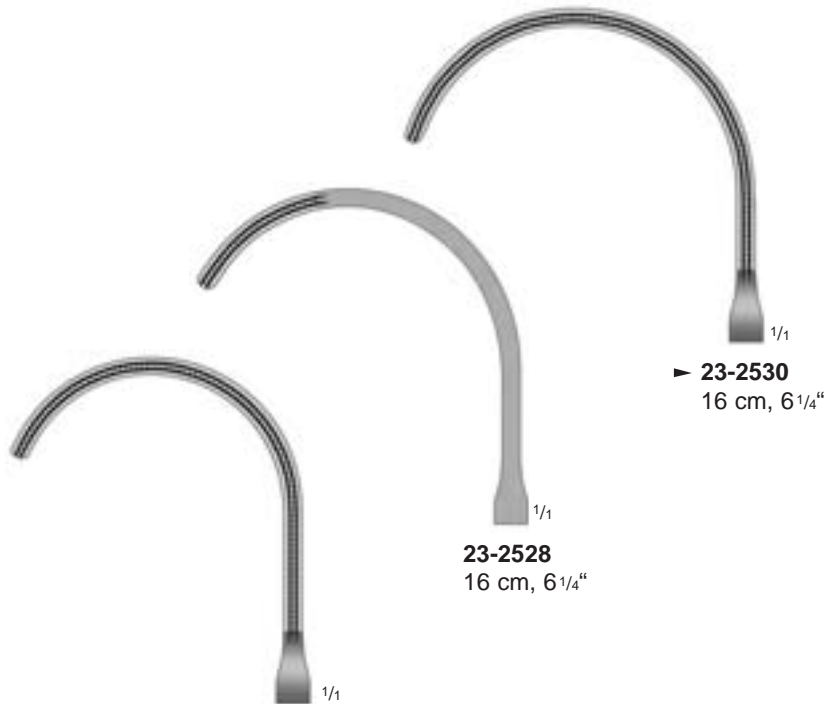

23-2529
 16 cm, 6¹/₄"

23-2528
 16 cm, 6¹/₄"

▶ **23-2530**
 16 cm, 6¹/₄"



ATRAUMATIC-GRIP Anastomosenklemmen mit DE BAKEY-Zahnung
ATRAUMATIC-GRIP Anastomosis Clamps with Toothing DE BAKEY
ATRAUMATIC-GRIP Pinzas-clamps para anastomosis con dentado DE BAKEY
ATRAUMATIC-GRIP Pincas-clamps à anastomose avec denture DE BAKEY
ATRAUMATIC-GRIP Pinze per anastomosi con dentatura DE BAKEY

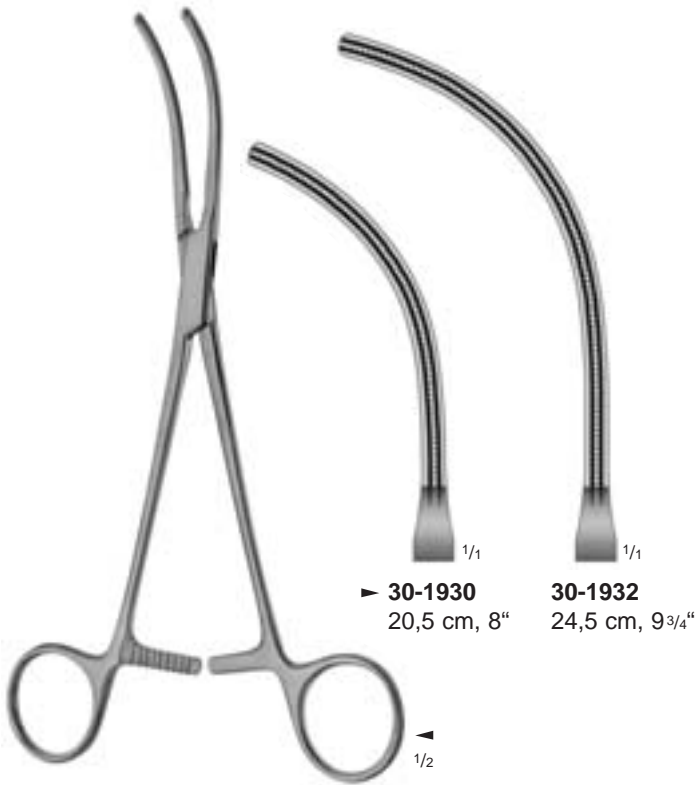

GLOVER
30-1930
- 30-1932

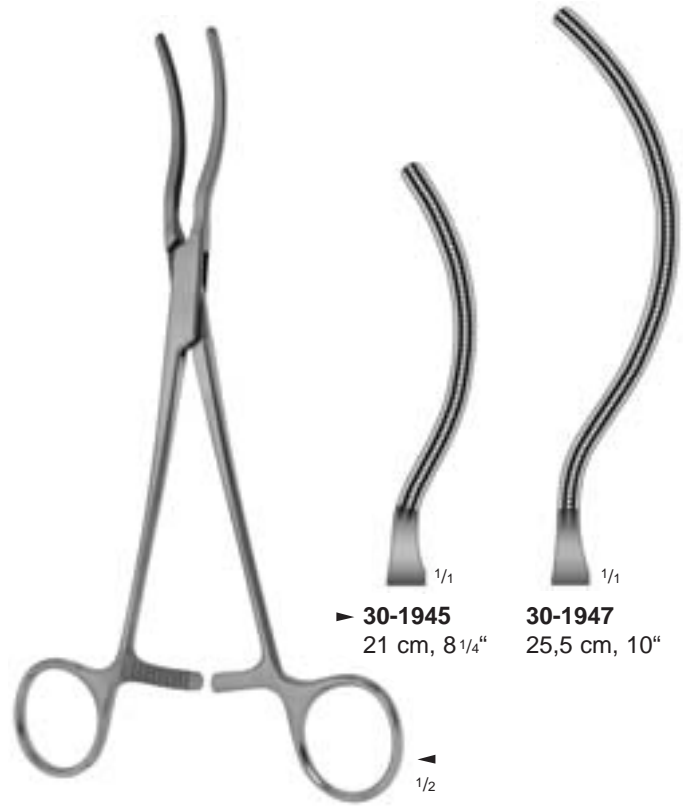

GLOVER
30-1945
- 30-1947



GLOVER
30-1940
- 30-1942



▶ 30-1940
18 cm, 7"



30-1942
22 cm, 8 3/4"

ATRAUMATIC-GRIP Aorta-Aneurysmaklemmen mit DE BAKEY-Zahnung
ATRAUMATIC-GRIP Aorta-Aneurysma Clamps with Toothing DE BAKEY
ATRAUMATIC-GRIP Pinzas-clamps para aneurisma de aorta con dentado DE BAKEY
ATRAUMATIC-GRIP Pincas-clamps pour anévrisme de l'aorte avec denture DE BAKEY
ATRAUMATIC-GRIP Pinze per l'aneurisma dell'aorta aorta con dentatura DE BAKEY



für temporären Verschluss der Iliac-Arterie
 for temporary occlusion of the arteria iliaca
 para la oclusión temporal de la arteria iliaca
 pour occlusion temporaire de l'artere iliaque
 per l'occlusione temporanea dell'arteria iliaca

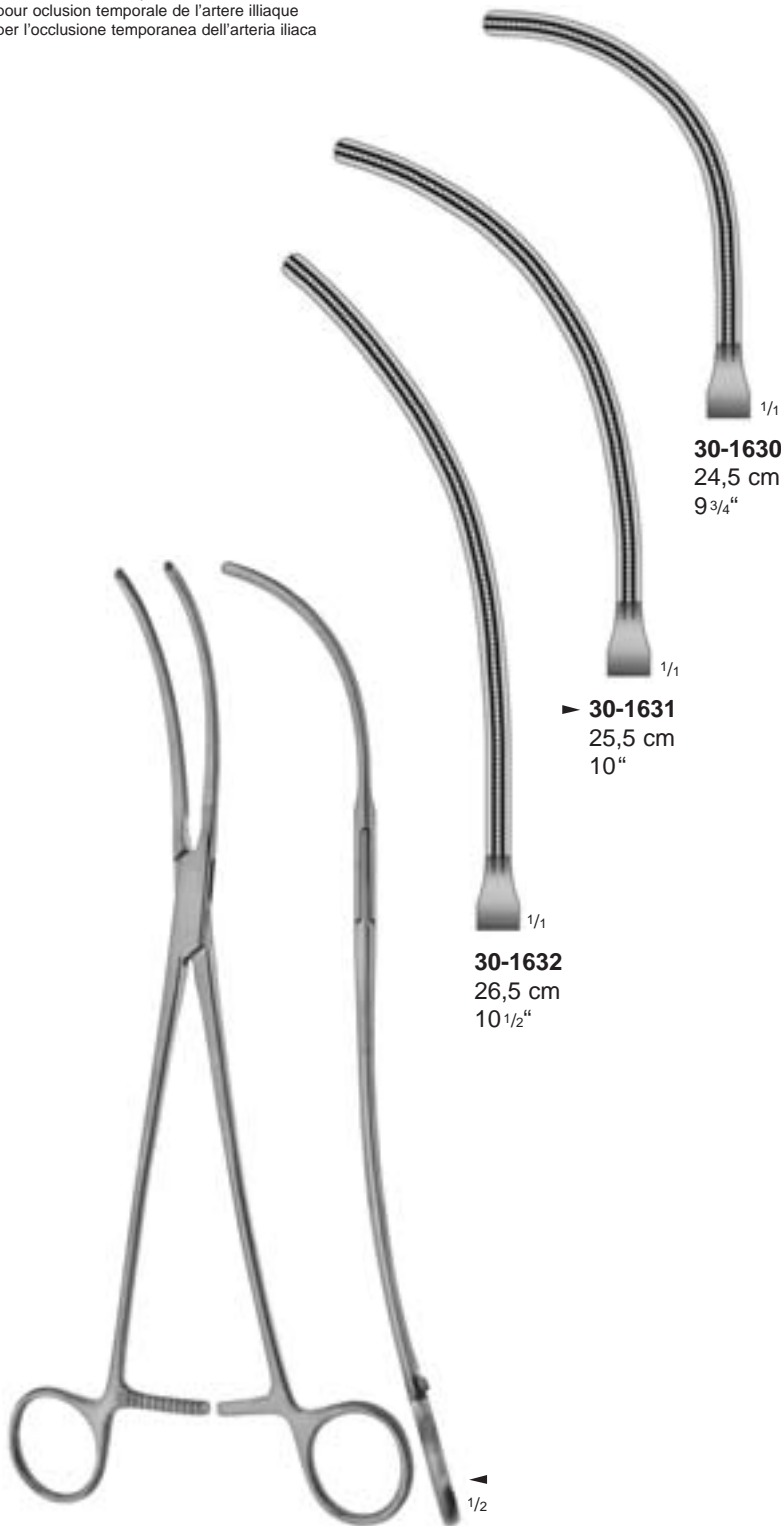

DE BAKEY-BAHNSON
 30-1630
 - 30-1632

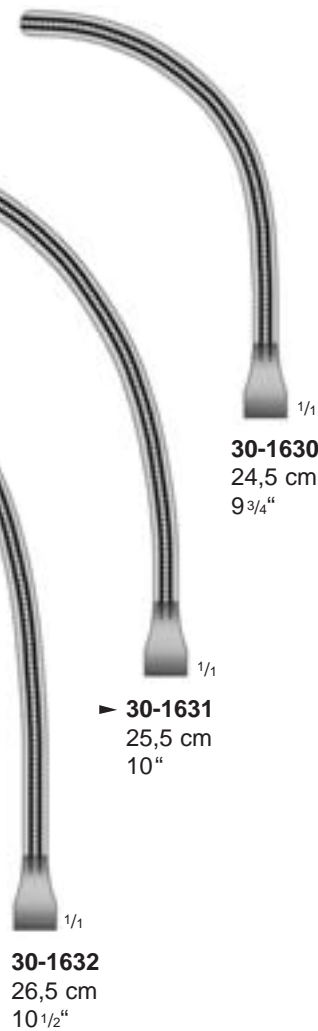

▶ 30-1631
 25,5 cm
 10"

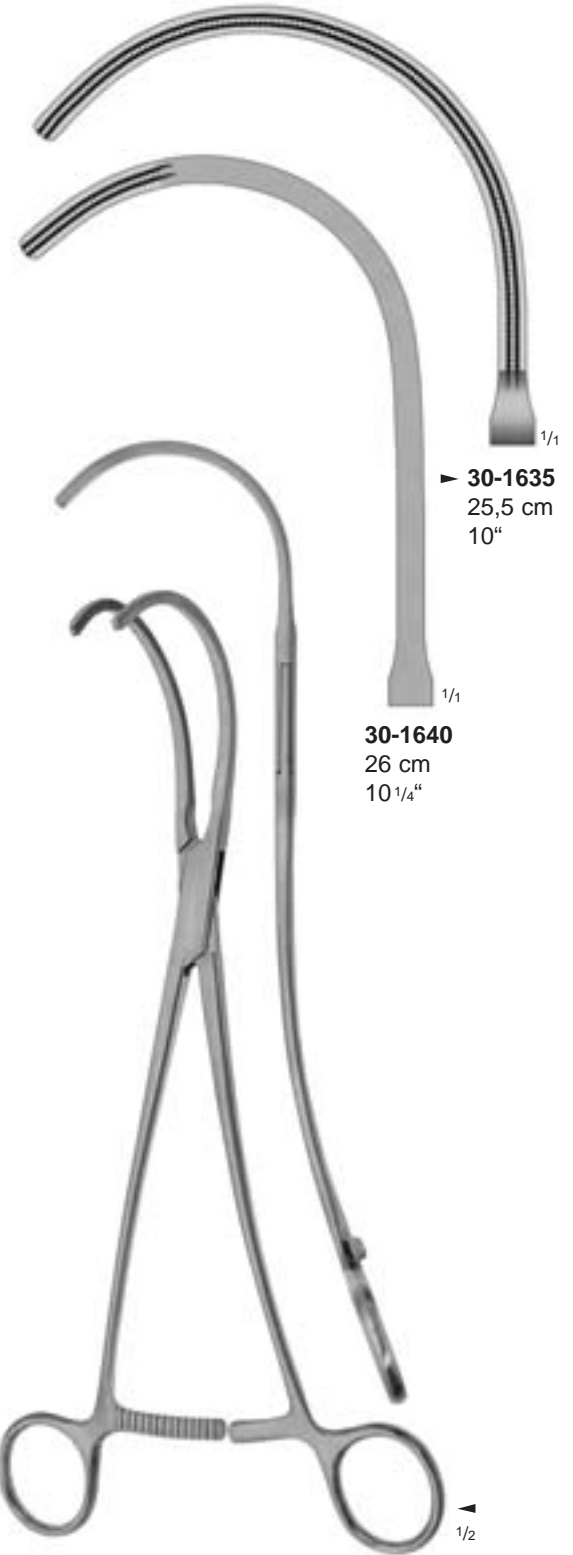

DE BAKEY
 30-1635
 - 30-1640

▶ 30-1635
 25,5 cm
 10"

30-1640
 26 cm
 10 1/4"



ATRAUMATIC-GRIP Aorta-Aneurysmaklemmen mit DE BAKEY-Zahnung

ATRAUMATIC-GRIP Aorta-Aneurysma Clamps with Toothing DE BAKEY

ATRAUMATIC-GRIP Pinzas-clamps para aneurisma de aorta con dentado DE BAKEY

ATRAUMATIC-GRIP Pincers-clamps pour anévrisme de l'aorte avec denture DE BAKEY

ATRAUMATIC-GRIP Pinze per l'aneurisma dell'aorta con dentatura DE BAKEY



30-1711
25,5 cm
10"

▶ **30-1713**
25,5 cm
10"

30-1715
23,5 cm
9 1/4"

DE BAKEY-CRAFOORD
30-1711
- **30-1715**



DE BAKEY-CRAFOORD
30-1719
26 cm, 10 1/4"

ATRAUMATIC-GRIP Aorta-Aneurysmaklemmen mit DE BAKEY-Zahnung
 ATRAUMATIC-GRIP Aorta-Aneurysma Clamps with Toothing DE BAKEY
 ATRAUMATIC-GRIP Pinzas-clamps para aneurisma de aorta con dentado DE BAKEY
 ATRAUMATIC-GRIP Pincers-clamps pour anévrisme de l'aorte avec denture DE BAKEY
 ATRAUMATIC-GRIP Pinze per l'aneurisma dell'aorta con dentatura DE BAKEY

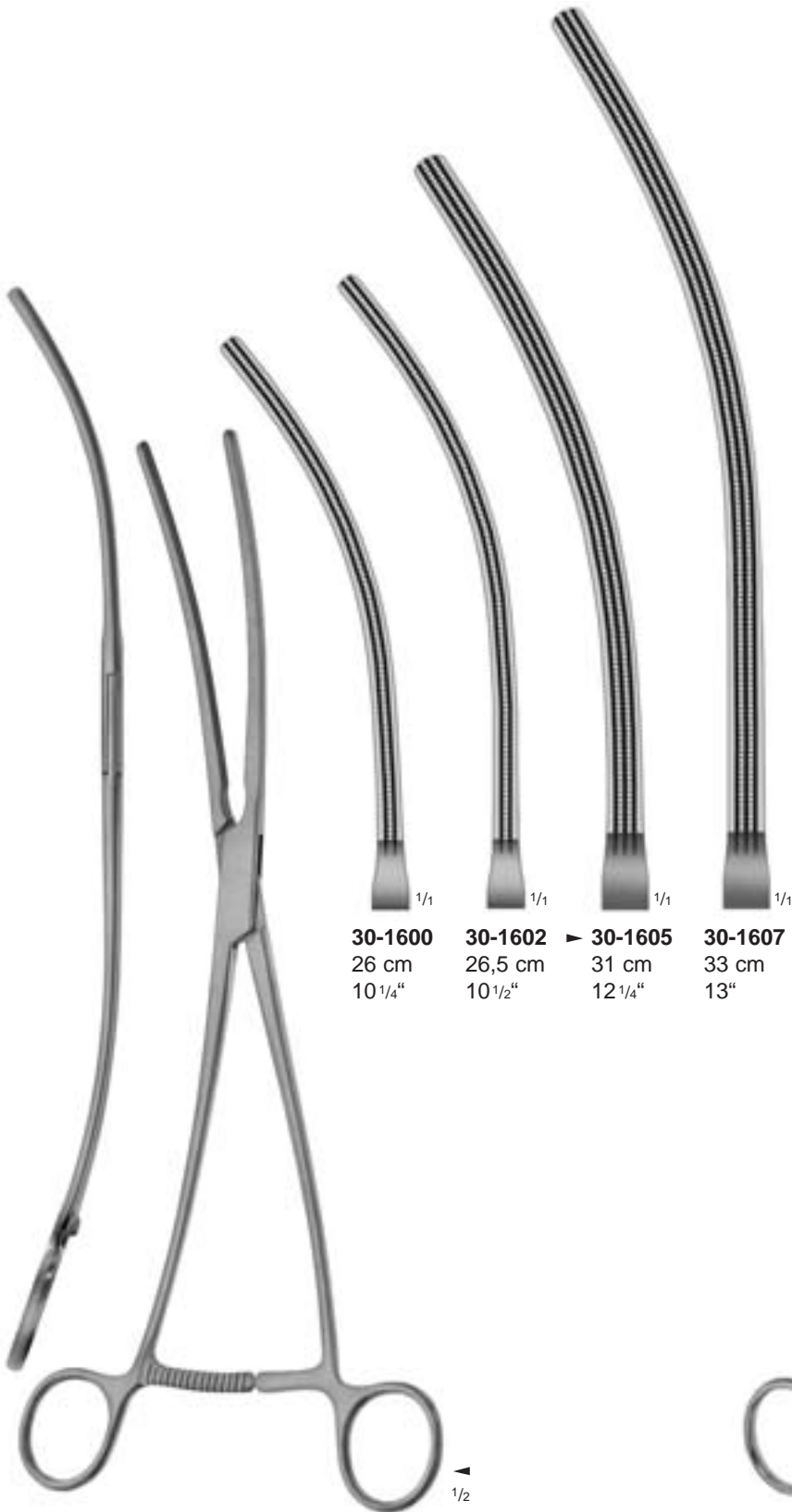

| | | | |
|----------------|----------------|------------------|----------------|
| 30-1600 | 30-1602 | ▶ 30-1605 | 30-1607 |
| 26 cm | 26,5 cm | 31 cm | 33 cm |
| 10 1/4" | 10 1/2" | 12 1/4" | 13" |

DE BAKEY
30-1600
 - **30-1607**

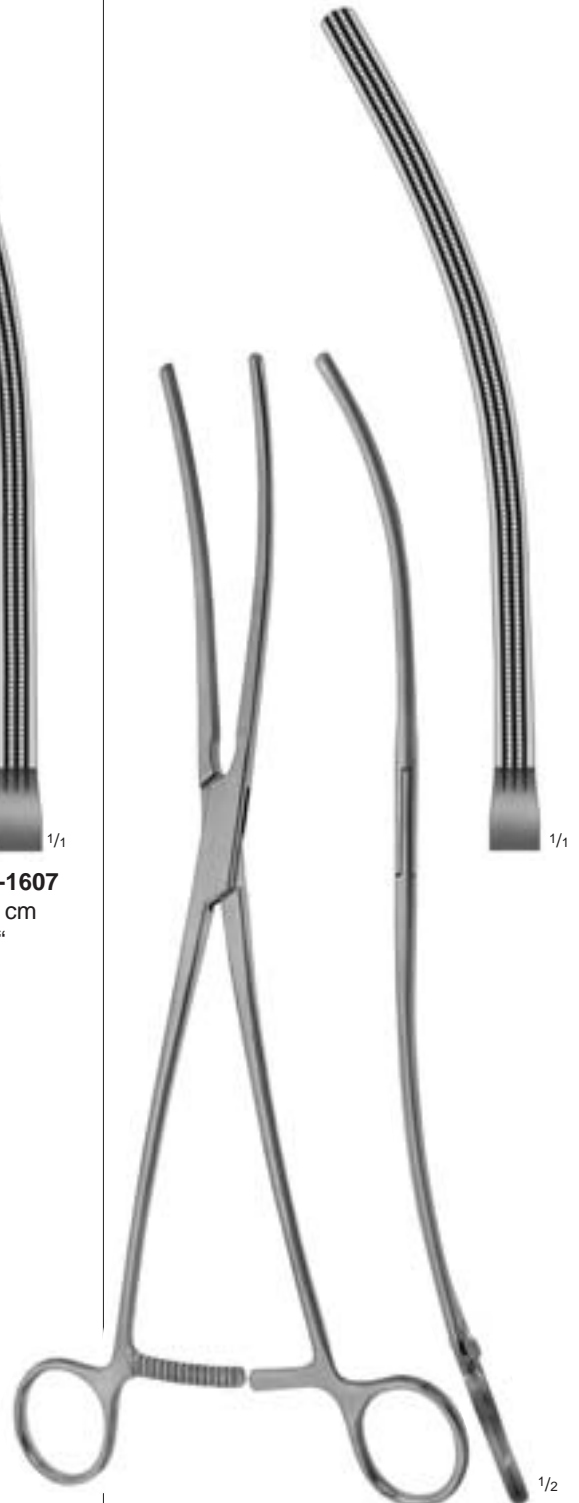

DE BAKEY
30-1610
 30,5 cm, 12"



ATRAUMATIC-GRIP Aorta-Anastomosenklemmen mit DE BAKEY-Zahnung
ATRAUMATIC-GRIP Aorta-Anastomosis Clamps with Toothing DE BAKEY
ATRAUMATIC-GRIP Pinzas-clamps para anastomosis de aorta con dentado DE BAKEY
ATRAUMATIC-GRIP Pinces-clamps à anastomose de l'aorte avec denture DE BAKEY
ATRAUMATIC-GRIP Pinze per l'anastomosi dell'aorta con dentatura DE BAKEY



1/1



1/1



1/2

WEBER
30-1642
25 cm, 10"

links
left
izquierda
à gauche
sinistra



1/2

WEBER
30-1643
25 cm, 10"

rechts
right
derecha
à droite
destra

ATRAUMATIC-GRIP Aorta-Anastomosenklemmen mit DE BAKEY-Zahnung
 ATRAUMATIC-GRIP Aorta-Anastomosis Clamps with Toothing DE BAKEY
 ATRAUMATIC-GRIP Pinzas-clamps para anastomosis de aorta con dentado DE BAKEY
 ATRAUMATIC-GRIP Pincas-clamps à anastomose de l'aorte avec denture DE BAKEY
 ATRAUMATIC-GRIP Pinze per l'anastomosi dell'aorta con dentatura DE BAKEY



▶ **30-1657**
19,5 cm, 7³/₄"

30-1658
20 cm, 8"

LAMBERT-KAY
30-1657
 - **30-1658**



▶ **30-1655**
22,5 cm, 9"

30-1656
23 cm, 9"

WYLIE
30-1655
 - **30-1656**



ATRAUMATIC-GRIP Vena-Cava-Klemmen mit DE BAKEY-Zahnung
 ATRAUMATIC-GRIP Vena-Cava Clamps with Toothing DE BAKEY
 ATRAUMATIC-GRIP Pinzas-clamps para vena cava con dentado DE BAKEY
 ATRAUMATIC-GRIP Pincas-clamps pour veine cave avec denture DE BAKEY
 ATRAUMATIC-GRIP Pinze per vena cava con dentatura DE BAKEY



DE BAKEY-BECK
30-1886
 - **30-1887**

1/2



► **30-1886**
 19 cm, 7 1/2"

30-1887
 21 cm, 8 1/4"



1/2



1/1

CALNE
30-1800
 27 cm, 10 3/4"

Die Spezialklemme ermöglicht ein den anatomischen Verhältnissen angepaßtes Anlegen an der Vena cava inferior oberhalb der Leber. Die Verriegelung am oberen Ende des Mauls hält nach dem Anlegen der Klemme die Maulteile fest zusammen und verhindert somit ein Ausschlüpfen der mit dem Zwerchfell abgeklemmten Vena cava inferior.

The special clamp makes it possible to clamp the vena cava inferior above the liver according to the anatomic conditions. The lock at the upper end of the jaws fixes firmly the parts of the jaws of the clamp after it is placed, thus impeding the vena cava inferior - clamped together with diaphragm - from slipping out.

Se facilita la colocación amoldada de la vena cava inferior sobre el hígado, por causa de la forma anatómica de la pinza clamp especial. El cierre a la punta de la mandíbula sujeta firmamente la pinza clamp y evita que se escape la vena cava inferior con el diafragma.

Le clamp spécial permet un clampage atraumatique de la Veine Cave inférieure au-dessus du foie, adapté aux conditions anatomiques. L'anneau terminal permet de maintenir les mors joints évitant ainsi le glissement de la Veine Cave supérieure clampée avec le diafragme.

La pinza permette di clampare la Vena Cava inferiore sopra il fegato data la sua forma anatomica. Il fermo nella parte superiore blocca saldamente le estremità della pinza impedendo che la Vena Cava inferiore scivoli via.

ATRAUMATIC-GRIP Präparier- und Ligaturklemmen mit DE BAKEY-Zahnung

ATRAUMATIC-GRIP Dissecting and Ligature Forceps with Toothing DE BAKEY

ATRAUMATIC-GRIP Pinzas para disección y ligaduras con dentado DE BAKEY

ATRAUMATIC-GRIP Pincès à disséquer et à ligatures avec denture DE BAKEY

ATRAUMATIC-GRIP Pinze per dissezione e legature con dentatura DE BAKEY

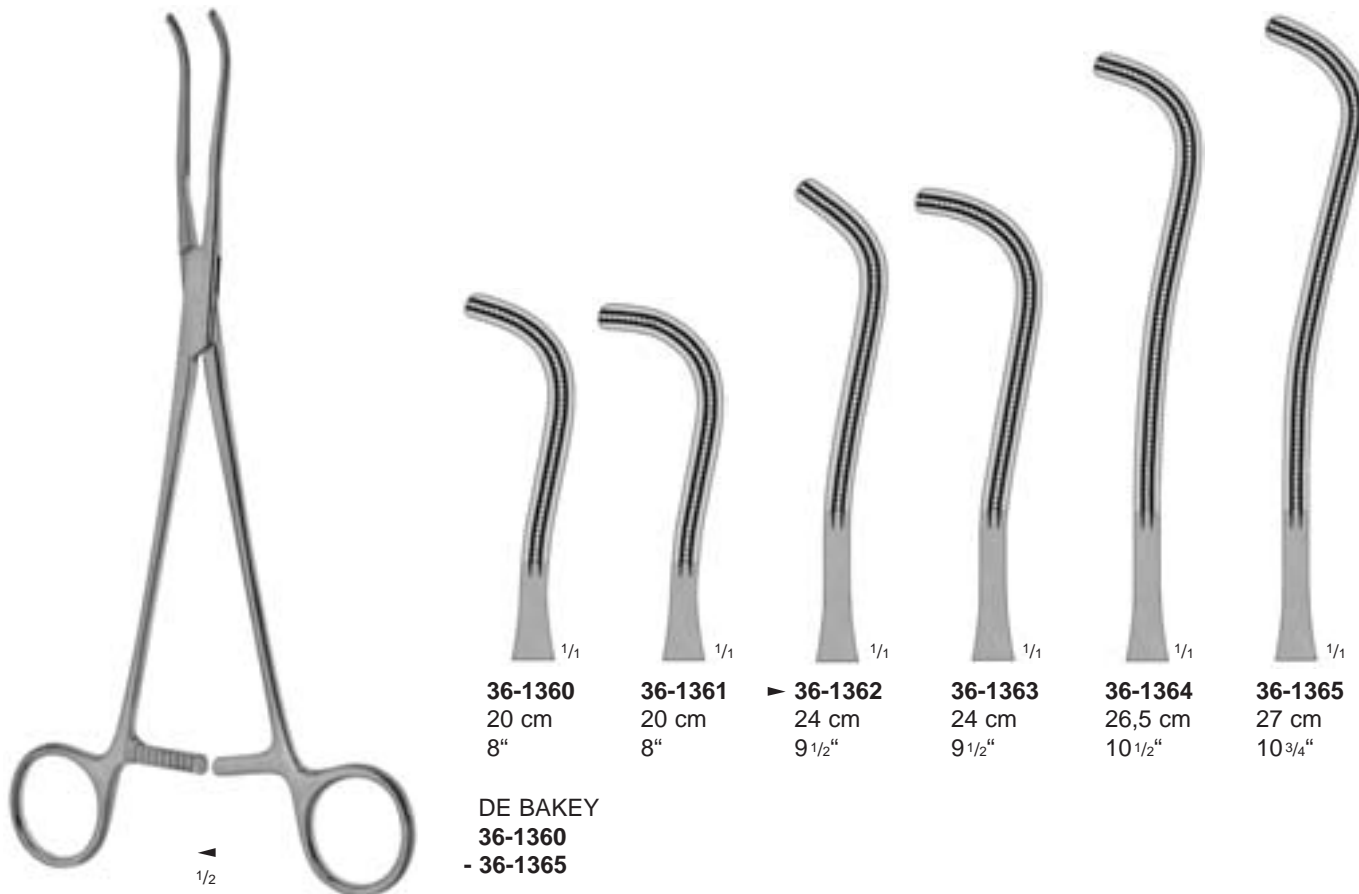
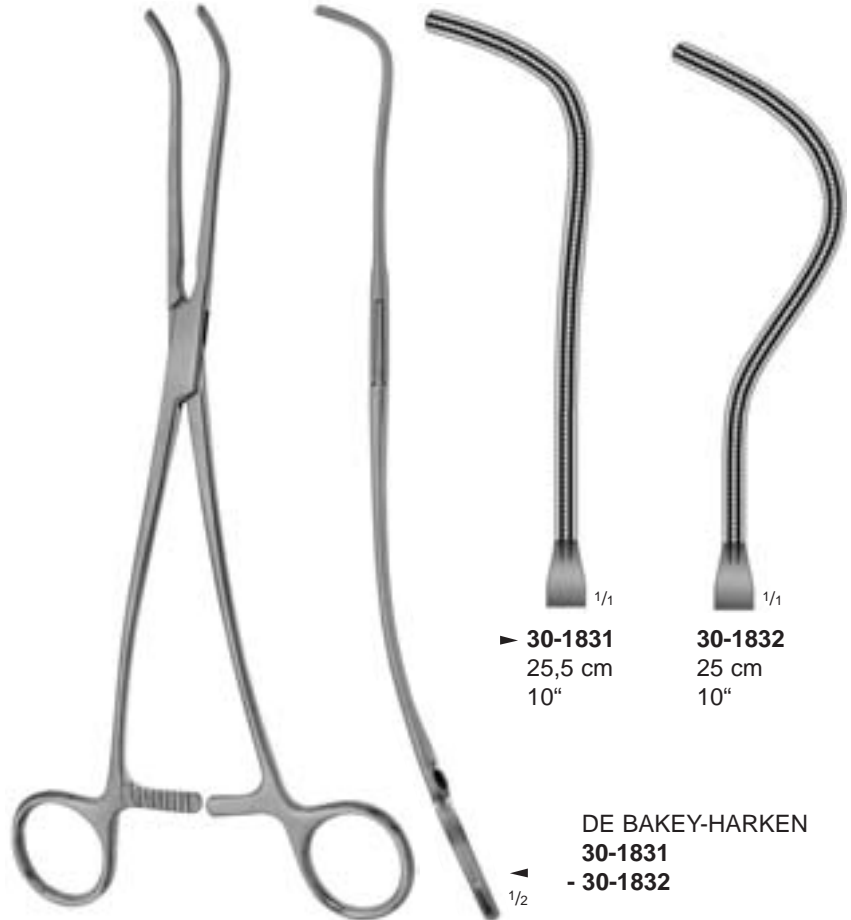



ATRAUMATIC-GRIP Bronchusklemmen mit DE BAKEY-Zahnung
ATRAUMATIC-GRIP Bronchus Clamps with Toothing DE BAKEY
ATRAUMATIC-GRIP Pinzas-clamps bronquiales con dentado DE BAKEY
ATRAUMATIC-GRIP Pincas-clamps à bronches avec denture DE BAKEY
ATRAUMATIC-GRIP Pinze per bronchi con dentatura DE BAKEY



LEES
36-1374
21 cm, 8 1/4"



LEES
36-1370
22 cm, 8 3/4"



LEES
36-1372
24,5 cm, 9 3/4"

ATRAUMATIC-GRIP Mehrzweckklemmen mit DE BAKEY-Zahnung

ATRAUMATIC-GRIP Multi-Purpose Clamps with Toothing DE BAKEY

ATRAUMATIC-GRIP Pinzas-clamps de varias aplicaciones con dentado DE BAKEY

ATRAUMATIC-GRIP Pincers-clamps universelles avec denture DE BAKEY

ATRAUMATIC-GRIP Pinze multiuso con dentatura DE BAKEY

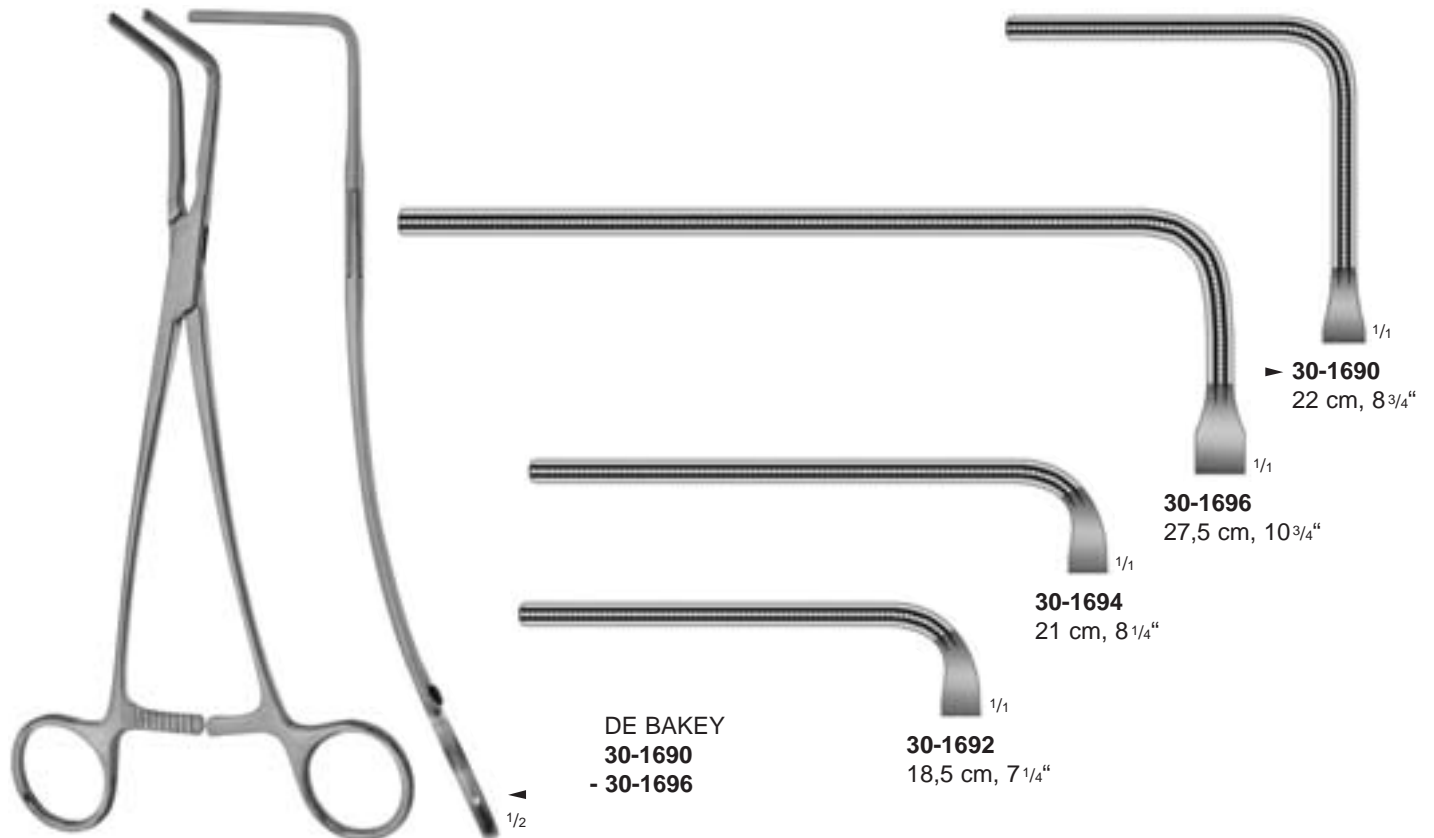
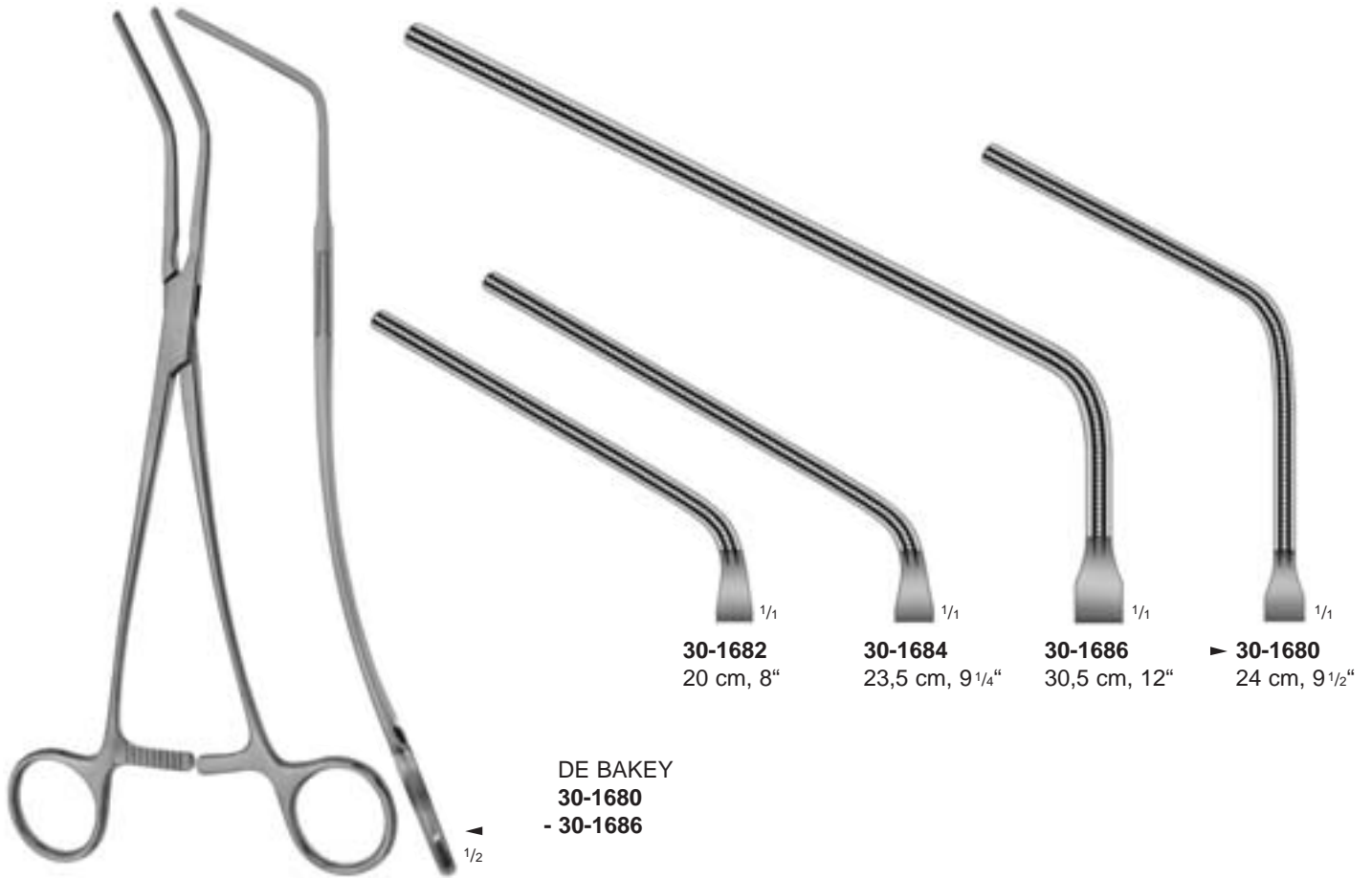



ATRAUMATIC-GRIP Mehrzweckklemmen mit DARDIK-Zahnung

ATRAUMATIC-GRIP Multi-Purpose Clamps with Toothing DARDIK

ATRAUMATIC-GRIP Pinzas-clamps de varias aplicaciones con dentado DARDIK

ATRAUMATIC-GRIP Pincers-clamps universelles avec denture DARDIK

ATRAUMATIC-GRIP Pinze multiuso con dentatura DARDIK



1/1

30-1720
15 cm, 6"



1/1

15 °
30-1722
15 cm, 6"



1/1

30 °
30-1724
15 cm, 6"



1/1

45 °
30-1726
14,5 cm, 5 3/4"



1/1

90 °
30-1728
13 cm, 5 1/8"

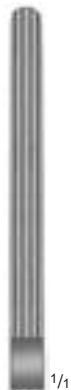

1/1

30-1730
16,5 cm, 6 1/2"



1/1

15 °
30-1732
16,5 cm, 6 1/2"



1/1

30 °
▶ **30-1734**
16 cm, 6 1/4"

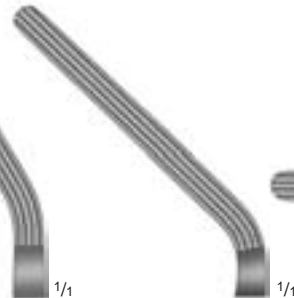

1/1

45 °
30-1736
16 cm, 6 1/4"



1/1

90 °
30-1738
13,5 cm, 5 1/4"



1/2

DARDIK
30-1720
- **30-1738**

ATRAUMATIC-GRIP Gefäßklemmen mit COOLEY-Zahnung
 ATRAUMATIC-GRIP Vascular Clamps with Toothing COOLEY
 ATRAUMATIC-GRIP Pinzas-clamps vasculares con dentado COOLEY
 ATRAUMATIC-GRIP Pincas vasculaires avec denture COOLEY
 ATRAUMATIC-GRIP Pinze vascolari con dentatura COOLEY



für Kinderchirurgie • for pediatric surgery • para la pediatría • pour chirurgie pédiatrique • per chirurgia pediatrica

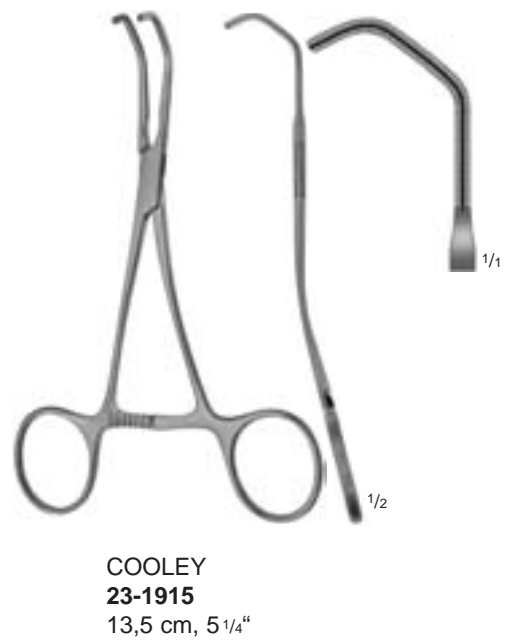
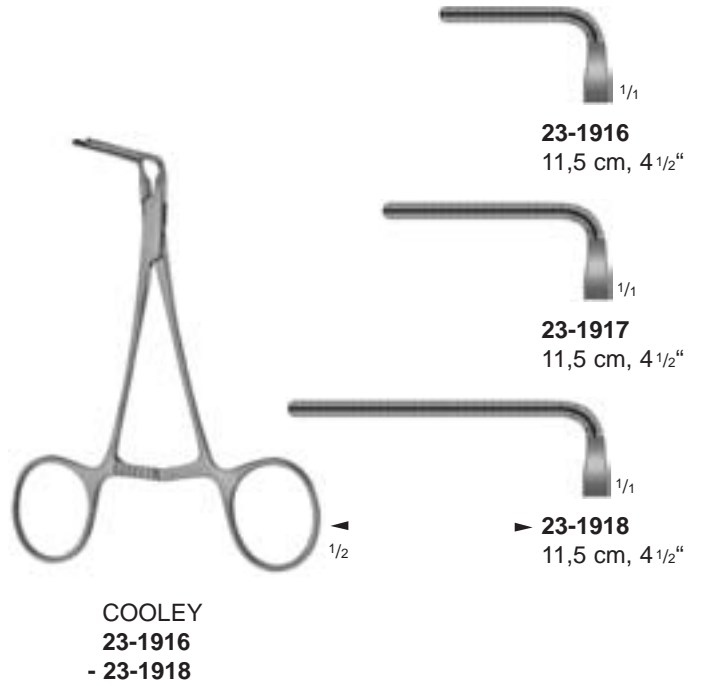
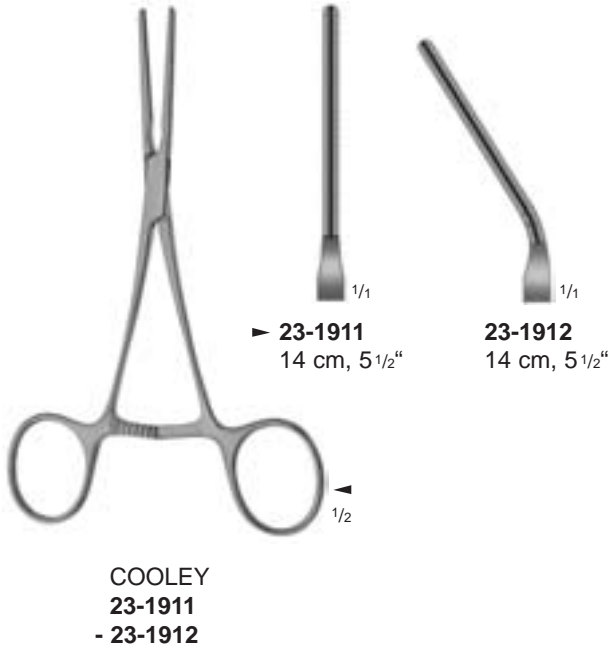



ATRAUMATIC-GRIP Gefäßklemmen mit COOLEY-Zahnung
 ATRAUMATIC-GRIP Blood Vessel Clamps with Toothing COOLEY
 ATRAUMATIC-GRIP Pinzas-clamps para vasos con dentado COOLEY
 ATRAUMATIC-GRIP Pinces vasculaires avec denture COOLEY
 ATRAUMATIC-GRIP Pinze vascolari con dentatura COOLEY



COOLEY
30-2158
 12,5 cm, 5"

Bulldogklemme
 Bulldog clamp
 Clamp Bulldog
 Clamp Bulldog
 Pinza Bulldog

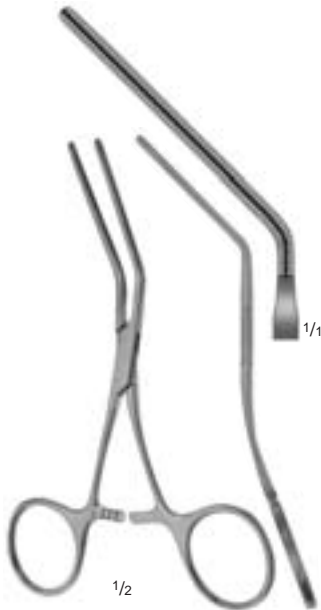

COOLEY
30-2154
 12,5 cm, 5"

Bulldogklemme
 Bulldog clamp
 Clamp Bulldog
 Clamp Bulldog
 Pinza Bulldog



COOLEY
23-2000
 15,5 cm, 6"

Patent-Ductusklemme
 Patent ductus clamp
 Pinza patente de conducto
 Clamp patent, ductus droit
 Clamp patent per dotto



COOLEY
23-2005
 15 cm, 6"

Patent-Ductusklemme
 Patent ductus clamp
 Pinza patente de conducto
 Clamp patent, ductus droit
 Clamp patent per dotto



COOLEY
23-1925
- 23-1935



► **23-1925**
 16 cm, 6 1/4"



23-1930
 15,5 cm, 6"



23-1935
 14 cm, 5 1/2"

Mehrzweckklemmen • Multi-purpose clamps • Pinzas-clamps de varias aplicaciones • Pinces-clamps universelles • Pinze multiuso

ATRAUMATIC-GRIP Coarctationsklemmen mit COOLEY-Zahnung

ATRAUMATIC-GRIP Coarctation Clamps with Toothing COOLEY

ATRAUMATIC-GRIP Pinzas-clamps para coarctación con dentado COOLEY

ATRAUMATIC-GRIP Pincès-clamps pour coarctation avec denture COOLEY

ATRAUMATIC-GRIP Pinze per coartazione con dentatura COOLEY



COOLEY
23-2025
16,5 cm, 6 1/2"



COOLEY
23-2030
16 cm, 6 1/4"



COOLEY
23-2035
17 cm, 6 3/4"

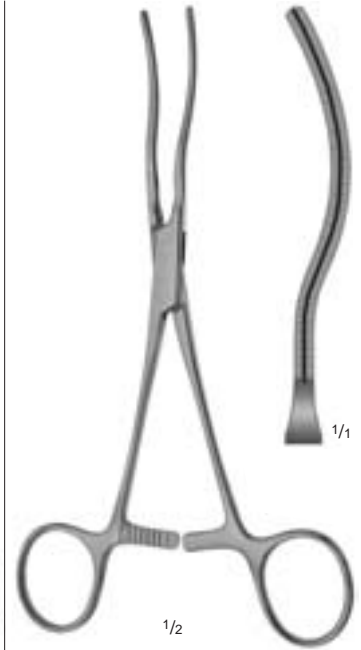

COOLEY
23-2036
17 cm, 6 3/4"

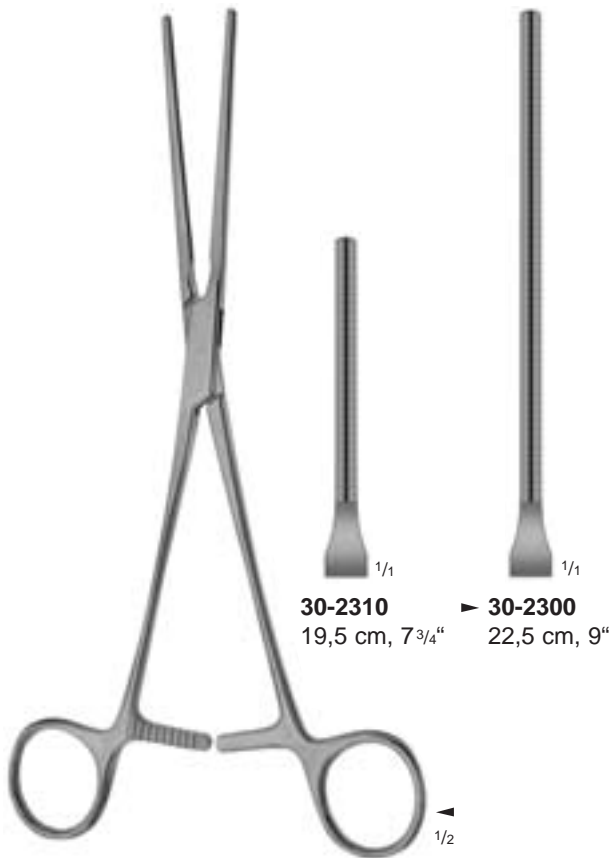

COOLEY
30-2300
- **30-2310**

30-2310 ▶ **30-2300**
19,5 cm, 7 3/4" 22,5 cm, 9"



COOLEY
30-2303
- **30-2313**

30-2313 ▶ **30-2303**
19 cm, 7 1/2" 22 cm, 8 3/4"



ATRAUMATIC-GRIP Gefäßklemmen mit COOLEY-Zahnung
 ATRAUMATIC-GRIP Vascular Clamps with Toothing COOLEY
 ATRAUMATIC-GRIP Pinzas-clamps vasculares con dentado COOLEY
 ATRAUMATIC-GRIP Pinces vasculaires avec denture COOLEY
 ATRAUMATIC-GRIP Pinze vascolari con dentatura COOLEY



COOLEY
30-2335
 18 cm, 7"
Peripheralklemme
 Peripheral vascular clamp
 Pinza-clamp para vasos periféricos
 Pince-clamp périphérique
 Pinza per vasi periferici



COOLEY
30-2690
 - **30-2691**
Iliaca Klemmen
 Iliac clamps
 Pinzas-clamps para iliaca
 Pinces-clamps iliaque
 Pinze iliaca



COOLEY
23-2090
 - **23-2092**

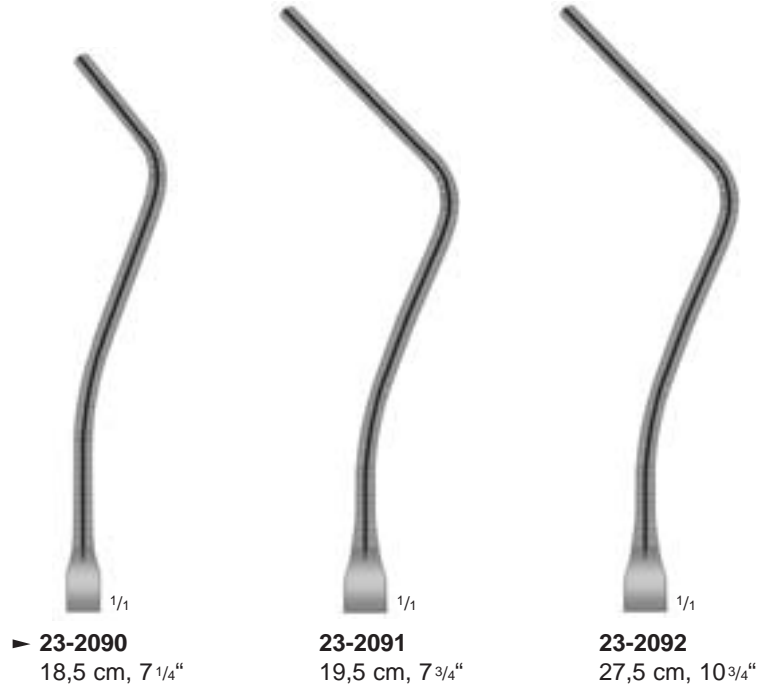

23-2090
 18,5 cm, 7 1/4"
23-2091
 19,5 cm, 7 3/4"
23-2092
 27,5 cm, 10 3/4"

Nierenarterienklemmen, auch für Schlüsselbein- und Halsschlagader
 Renal artery clamps, also used for subclavian and carotid artery
 Pinzas-clamps para las arterias renales, también se usan para la arteria clavicula y carótida
 Pinces hémostatiques rénales, également utilisées pour l'artère claviculaire et la carotide
 Pinze emostatiche per arterie renale, impiegate anche per l'arteria succlavia e la carotide

ATRAUMATIC-GRIP Anastomosenklemmen mit COOLEY-Zahnung

ATRAUMATIC-GRIP Anastomosis Clamps with Toothing COOLEY

ATRAUMATIC-GRIP Pinzas-clamps para anastomosis con dentado COOLEY

ATRAUMATIC-GRIP Pinces-clamps à anastomose avec denture COOLEY

ATRAUMATIC-GRIP Pinze per anastomosi con dentatura COOLEY

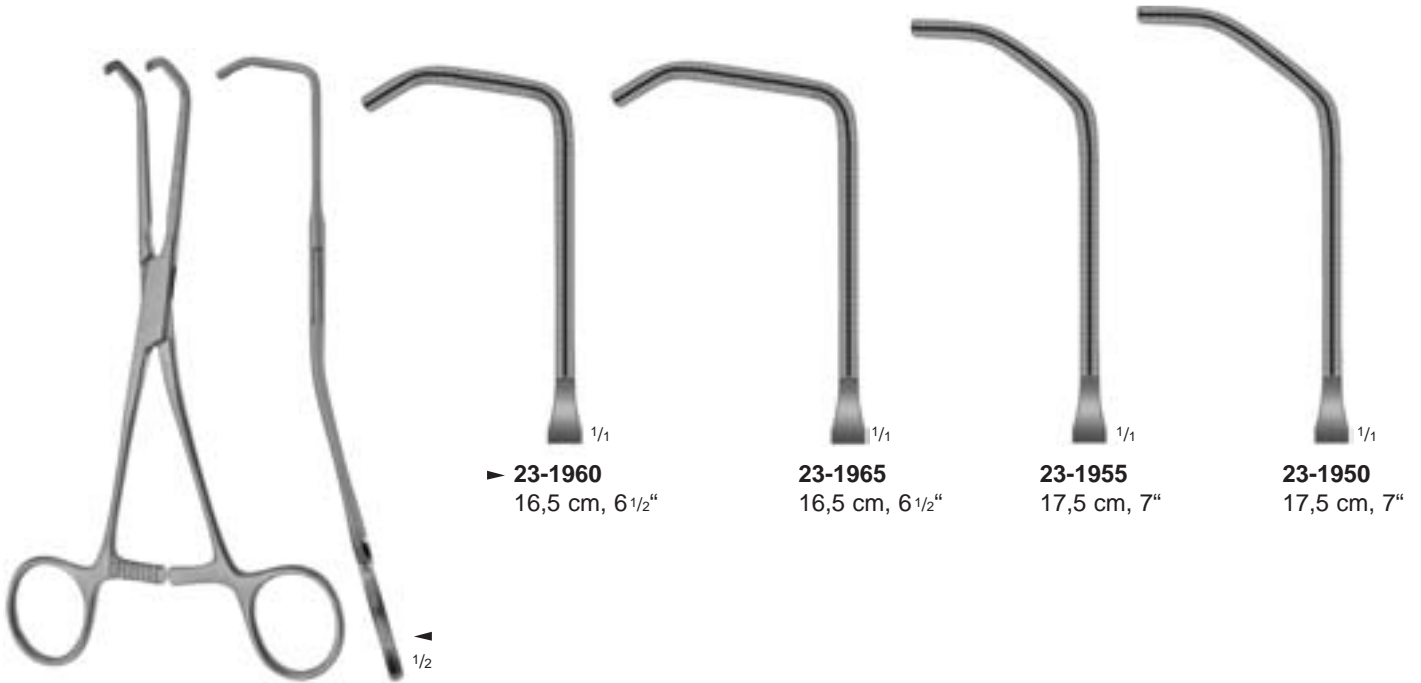

▶ **23-1960**
16,5 cm, 6 1/2"

23-1965
16,5 cm, 6 1/2"

23-1955
17,5 cm, 7"

23-1950
17,5 cm, 7"

COOLEY-REYNOLDS
23-1950
- 23-1965

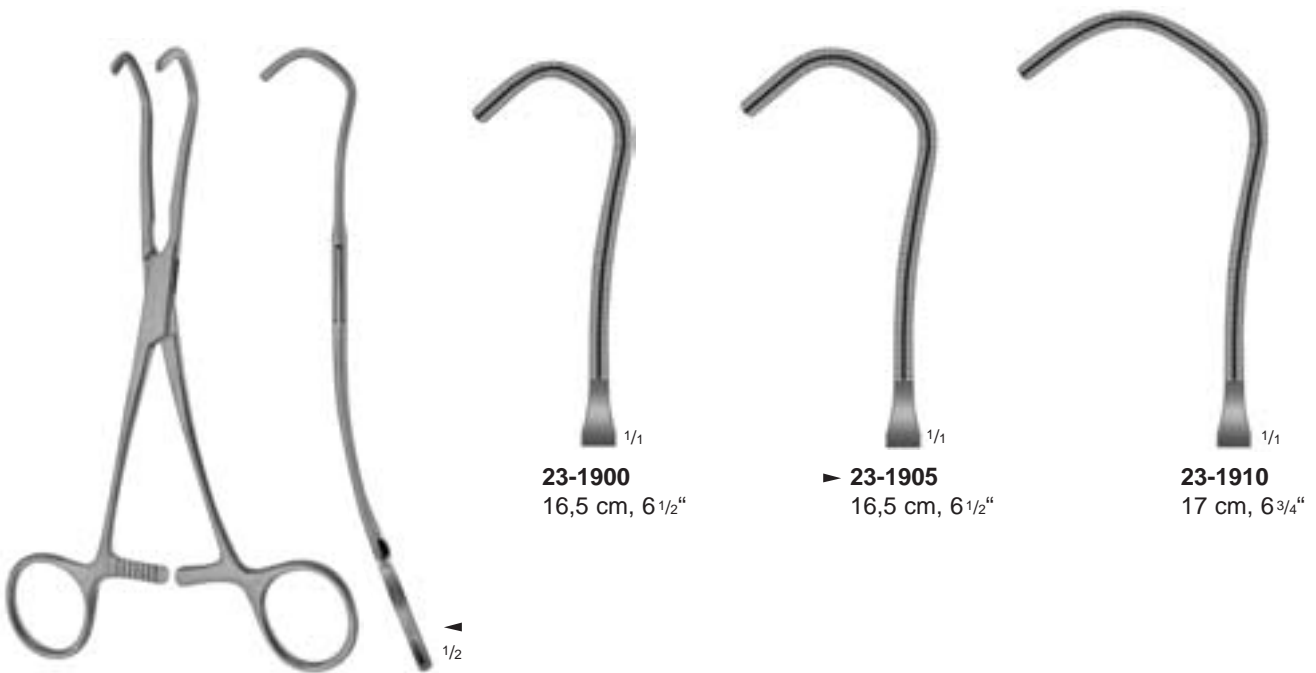

23-1900
16,5 cm, 6 1/2"

▶ **23-1905**
16,5 cm, 6 1/2"

23-1910
17 cm, 6 3/4"

COOLEY-DERRA
23-1900
- 23-1910



ATRAUMATIC-GRIP Anastomosenklemmen mit COOLEY-Zahnung

ATRAUMATIC-GRIP Anastomosis Clamps with Toothing COOLEY

ATRAUMATIC-GRIP Pinzas-clamps para anastomosis con dentado COOLEY

ATRAUMATIC-GRIP Pinces-clamps à anastomose avec denture COOLEY

ATRAUMATIC-GRIP Pinze per anastomosi con dentatura COOLEY



COOLEY
23-1976
17 cm, 6³/₄"

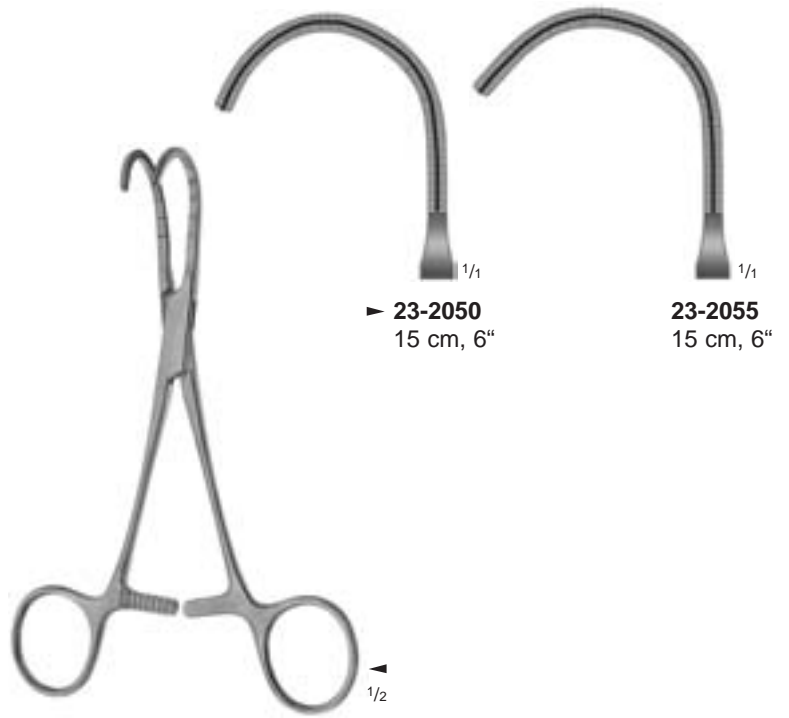

COOLEY-BECK
23-2050
- 23-2055

▶ 23-2050
15 cm, 6"

23-2055
15 cm, 6"

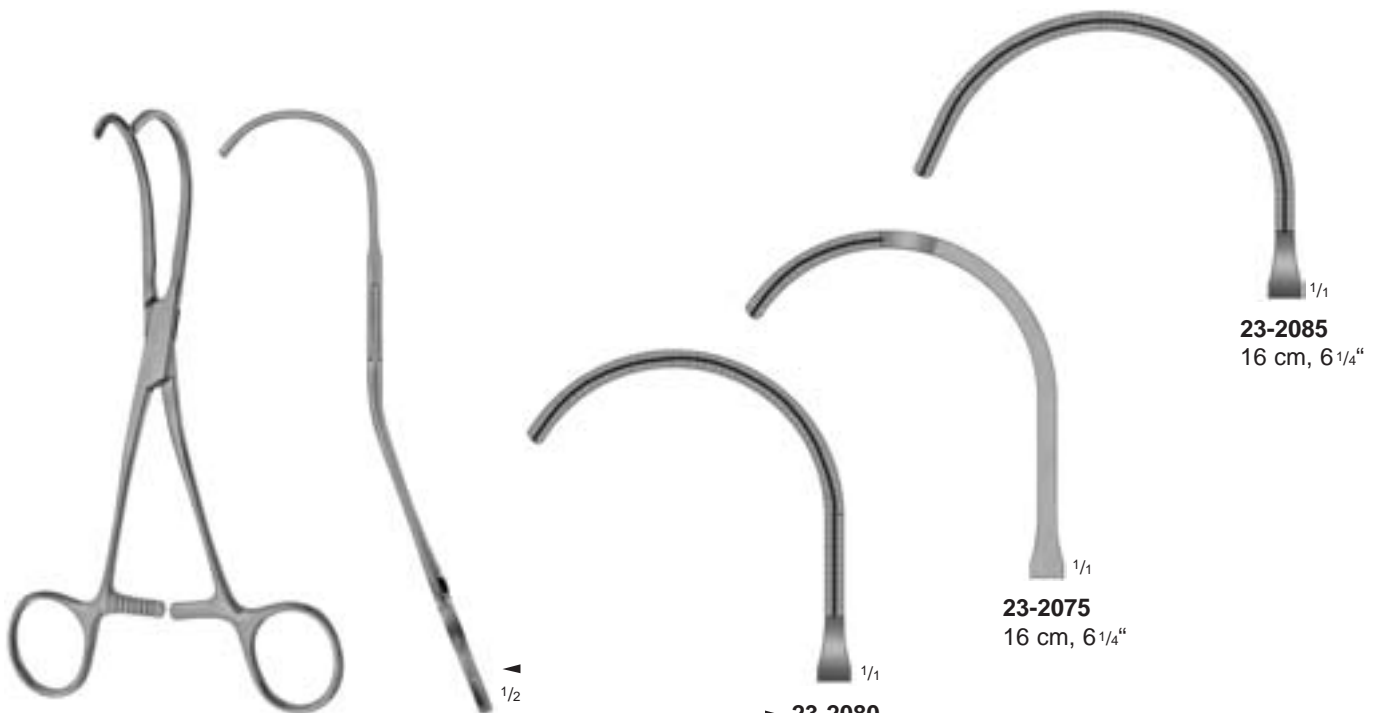

COOLEY
23-2075
- 23-2085

▶ 23-2080
16 cm, 6¹/₄"

23-2075
16 cm, 6¹/₄"

23-2085
16 cm, 6¹/₄"

ATRAUMATIC-GRIP Gefäßklemmen mit COOLEY-Zahnung
 ATRAUMATIC-GRIP Vascular Clamps with Toothing COOLEY
 ATRAUMATIC-GRIP Pinzas-clamps vasculares con dentado COOLEY
 ATRAUMATIC-GRIP Pincas vasculaires avec denture COOLEY
 ATRAUMATIC-GRIP Pinze vascolari con dentatura COOLEY



COOLEY
30-2602
 26,5 cm, 10 1/2"

Aorta-Aneurysmaklemme
 Aortic aneurysma clamp
 Pinza-clamp para aneurisma de aorta
 Pince-clamp pour anévrisme de l'aorte
 Pinza per l'aneurisma dell'aorta



COOLEY
30-2695
 25 cm, 10"

Aortaklemme
 Aortic clamp
 Pinza-clamp para aorta
 Pince-clamp pour aorte
 Pinza per aorta



ATRAUMATIC-GRIP Gefäßklemmen mit COOLEY-Zahnung
 ATRAUMATIC-GRIP Vascular Clamps with Toothing COOLEY
 ATRAUMATIC-GRIP Pinzas-clamps vasculares con dentado COOLEY
 ATRAUMATIC-GRIP Pincés vasculaires avec denture COOLEY
 ATRAUMATIC-GRIP Pinze vascolari con dentatura COOLEY



1/2

COOLEY
30-2660
 - **30-2668**

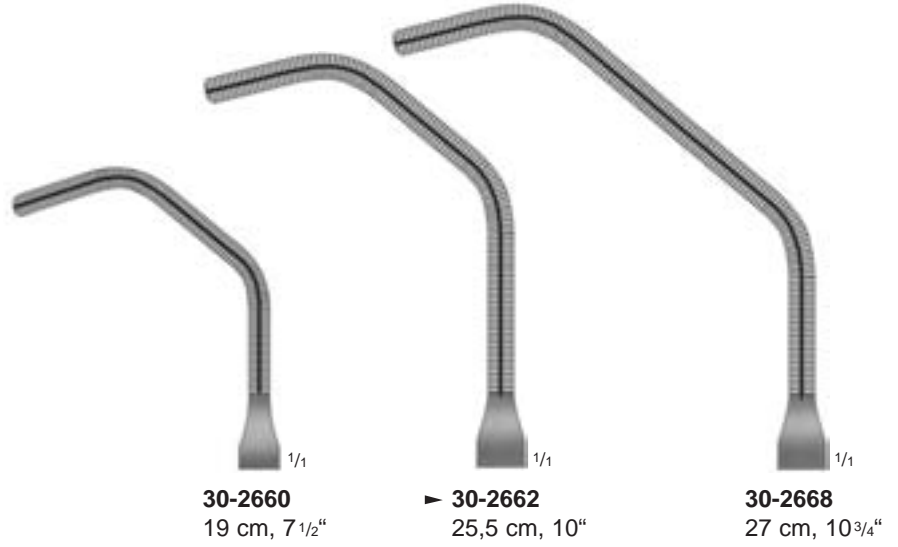

Gefäßklemmen für Tangential-Verschluss
 Tangential occlusion clamps
 Pinzas-clamps para oclusión tangencial
 Pincés-clamps pour occlusion tangentielle
 Pinze per occlusione tangenziale



1/2

COOLEY
30-2682
 - **30-2684**

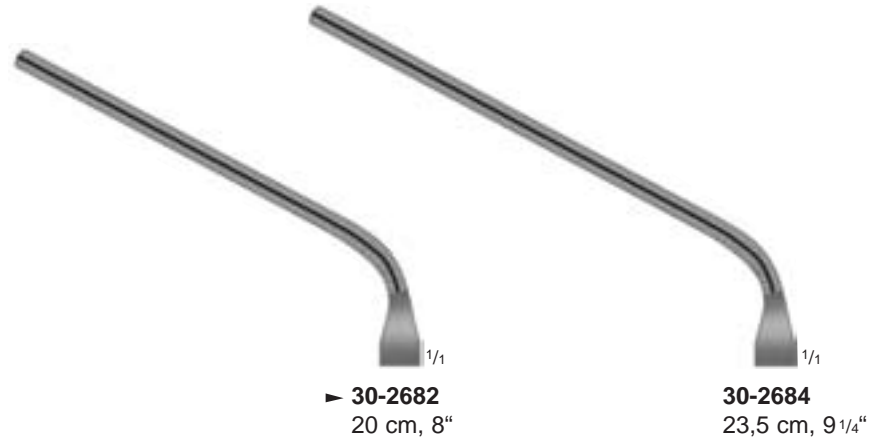

Mehrweckklemmen
 Multi-purpose clamps
 Pinzas-clamps de varias aplicaciones
 Pincés-clamps universelles
 Pinze multiuso

Halbflexible Gefäßklemmen

Semi Flexible Vascular Clamps

Pinzas-clamps vasculares semi-flexibles

Pinces vasculaires semi flexibles

Pinze vascolari semi flessibili



30-1950
12 mm

**Längsriefung,
für A. Carotis**

longitudinal
serration, for A. Carotis

Estriada longitudinal,
para A. Carotis

Striures longitudinales
pour artère carotide

fermo logitudinale,
per l'arteria carotide

1/1



30-1960
12 mm

**glatt
für A. Carotis**

smooth,
for A. Carotis

lisa,
para A. Carotis

lisse
pour artère carotide

liscia,
per l'arteria carotide

1/1



30-1952
20 mm

**Längsriefung,
für A. Poplitea**

longitudinal
serration, for A. Poplitea

Estriada longitudinal,
para A. Poplitea

Striures longitudinales
pour artère poplitée

fermo longitudinale
per l'arteria poplitea

1/1



30-1962
20 mm

**glatt
für A. Poplitea**

smooth,
for A. Poplitea

lisa,
para A. Poplitea

lisse
pour artère poplitée

liscia,
per l'arteria poplitea

1/1



30-1954
30 mm

**Längsriefung,
für A. Femoralis**

longitudinal
serration, for A. Femoralis

Estriada longitudinal,
para A. Femoralis

Striures longitudinales
pour artère fémorale

fermo longitudinale
per l'arteria femorale

1/1



30-1964
30 mm

**glatt
für A. Femoralis**

smooth,
for A. Femoralis

lisa,
para A. Femoralis

lisse
pour artère fémorale

liscia,
per l'arteria femorale

1/1



1/2

30-1950
- 30-1964
23 cm, 9"



Präparier- und Ligaturklemmen

Dissecting and Ligature Forceps
 Pinzas de disección y ligaduras
 Pincas à disséquer et à ligatures
 Pinze per dissezione e legature

Aurikelklemmen

Auricle Clamps
 Pinzas para la aurícula atril
 Pincas-clamps auriculaires
 Pinze ventricolare

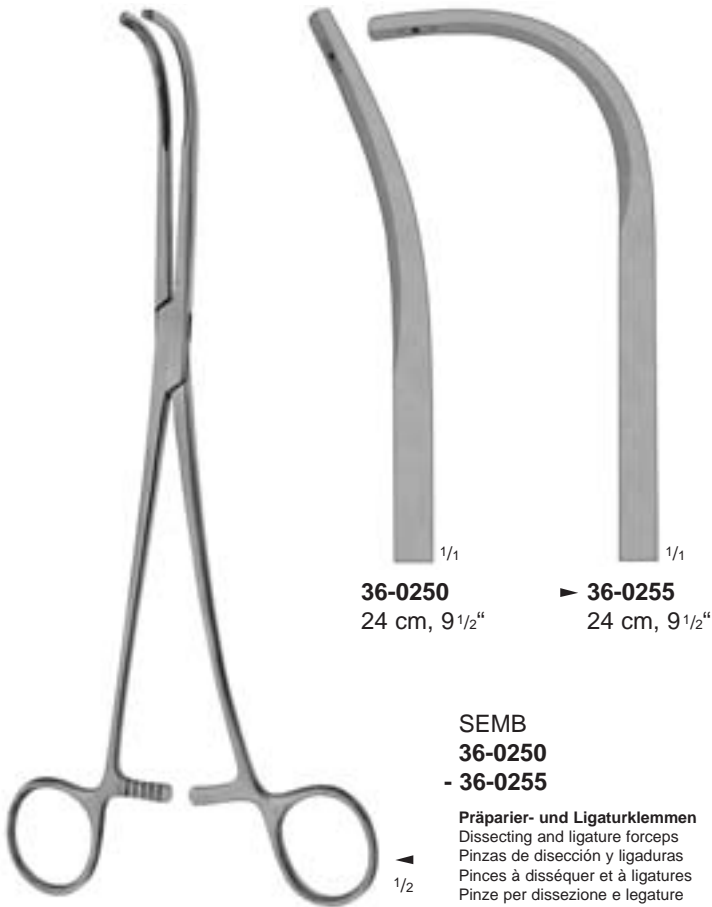

36-0250
24 cm, 9 1/2"

► **36-0255**
24 cm, 9 1/2"

SEMB
36-0250
 - **36-0255**

Präparier- und Ligaturklemmen
 Dissecting and ligature forceps
 Pinzas de disección y ligaduras
 Pincas à disséquer et à ligatures
 Pinze per dissezione e legature

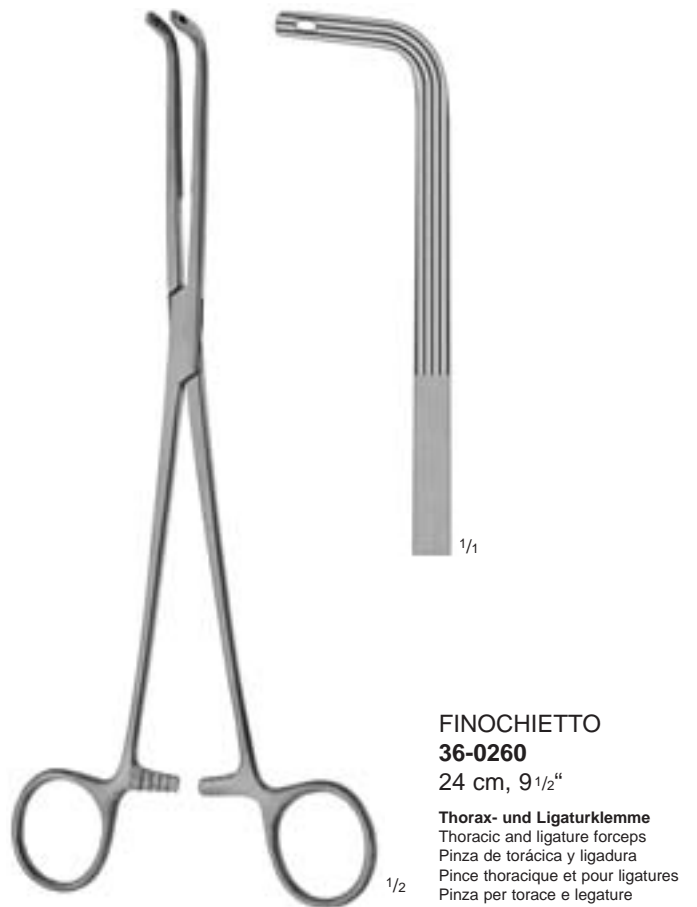

FINOCHIETTO
36-0260
 24 cm, 9 1/2"

Thorax- und Ligaturklemme
 Thoracic and ligature forceps
 Pinza de torácica y ligadura
 Pince thoracique et pour ligatures
 Pinza per torace e legature

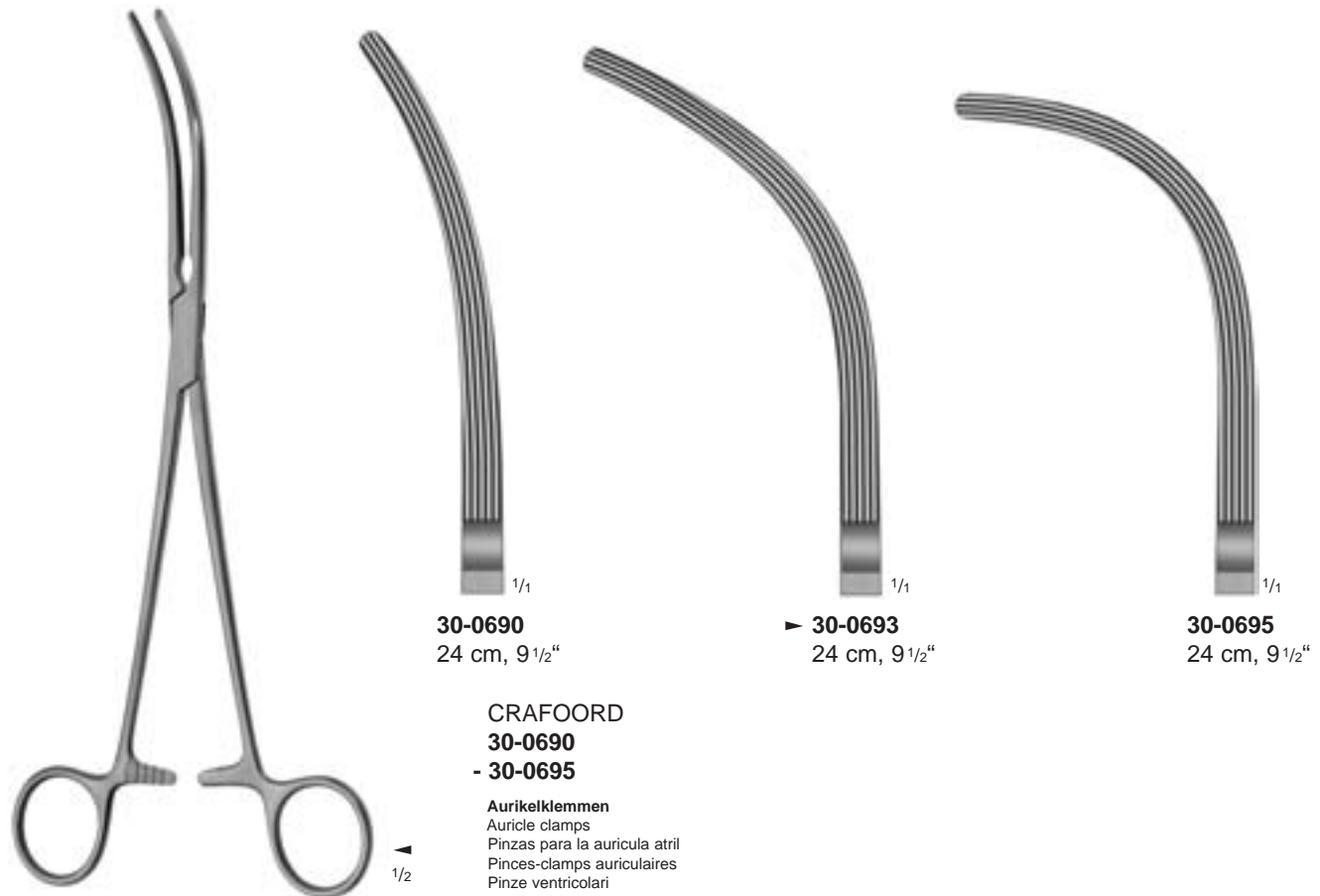

30-0690
24 cm, 9 1/2"

► **30-0693**
24 cm, 9 1/2"

30-0695
24 cm, 9 1/2"

CRAFOORD
30-0690
 - **30-0695**

Aurikelklemmen
 Auricle clamps
 Pinzas para la aurícula atril
 Pincas-clamps auriculaires
 Pinze ventricolari

Anastomosen- (Vena cava) Klemme

Anastomosis (Vena Cava) Clamps

Pinzas-clamps para anastomosis (vena cava)

Pinces-clamps à anastomose (veine cave)

Pinze per anastomosi (vena cava)

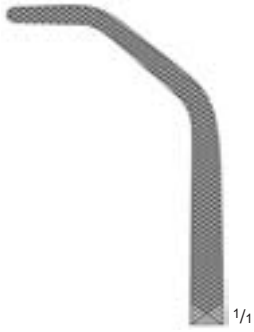

1/1



1/1

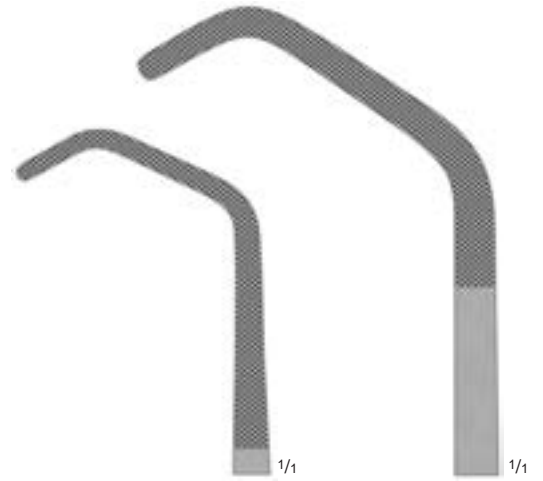

1/1

1/1

30-0811
20,5 cm, 8"

▶ **30-0810**
27 cm, 10³/₄"



1/2

BABY-SATINSKY
30-0801
16 cm, 6¹/₄"



1/2

SATINSKY
30-0800
24 cm, 9¹/₂"



1/2

SATINSKY
30-0810
- **30-0811**



Bronchusklemmen

Bronchus Forceps
 Pinzas-clamps bronquiales
 Pincas-clamps à bronches
 Pinze per legature

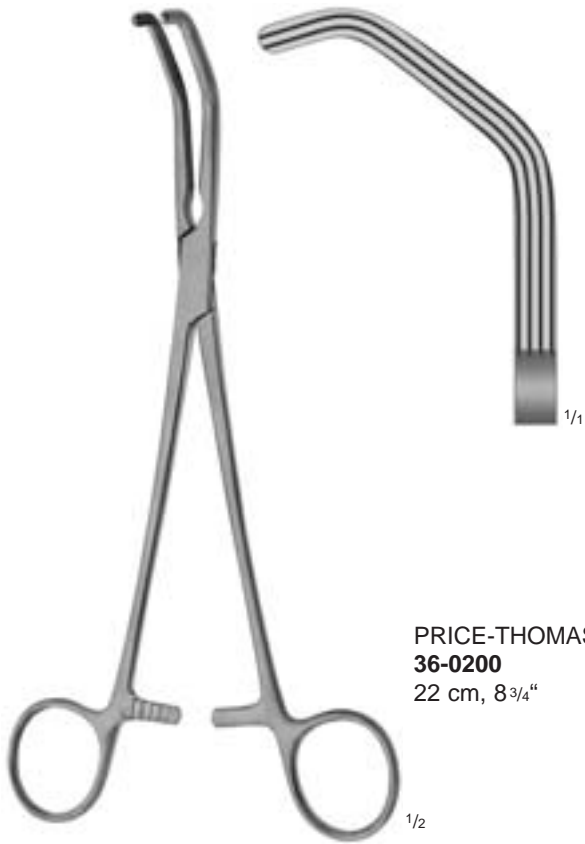

PRICE-THOMAS
36-0200
 22 cm, 8³/₄"



▶ **36-0201**
 22 cm, 8³/₄"

36-0202
 22 cm, 8³/₄"

PRICE-THOMAS
36-0201
 - **36-0202**

mit Stiften im Maul
 jaw with pins
 con dientes
 avec dents
 con denti



SAROT
36-0410
 - **36-0415**

mit Stiften im Maul
 jaw with pins
 con dientes
 avec dents
 con denti



▶ **36-0410**
 22,5 cm, 9"



36-0415
 22,5 cm, 9"



LAWNTON
Medizintechnik



Knochenchirurgie
Bone Surgery
Cirugía ósea
Chirurgie osseuse
Chirurgia ossea



Instrumente für Knochenchirurgie
 Instruments for Bone Surgery
 Instrumentos para cirugía ósea
 Instruments pour chirurgie osseuse
 Strumenti per chirurgia ossea



| | | |
|---|--------|---------|
| Resektions- und Amputationsmesser | Seite | 38 - 39 |
| Resection and Amputation Knives | Page | 38 - 39 |
| Cuchillos para resección y amputación | Página | 38 - 39 |
| Couteaux à résection et amputation | Page | 38 - 39 |
| Bisturi per resezione e amputazione | Pagina | 38 - 39 |



| | | |
|-----------------------------|--------|-----|
| Scharfe Löffel | Seite | 466 |
| Bone Curettes | Page | 466 |
| Cucharillas cortantes | Página | 466 |
| Curettes | Page | 466 |
| Curette per ossa | Pagina | 466 |



| | | |
|--|--------|-----|
| Sternummeißel | Seite | 492 |
| Sternum Chisel | Page | 492 |
| Cinzel para esternón | Página | 492 |
| Cisailles et ciseau-burins à sternum | Page | 492 |
| Scalpello per sterno | Pagina | 492 |



| | | |
|---------------------|--------|-----------|
| Rippenscheren | Seite | 492 - 493 |
| Rib Shears | Page | 492 - 493 |
| Costótomos | Página | 492 - 493 |
| Costotomes | Page | 492 - 493 |
| Costotomi | Pagina | 492 - 493 |



| | | |
|------------------------------------|--------|-----|
| Rippen- und Knochenfaßzangen | Seite | 493 |
| Rib and Bone Holding Forceps | Page | 493 |
| Pinzas para huesos | Página | 493 |
| Daviers porte-os | Page | 493 |
| Tenaglie per ossa | Pagina | 493 |



| | | |
|------------------------------------|--------|-----|
| Knochensplitterzangen | Seite | 494 |
| Bone Cutting Forceps | Page | 494 |
| Pinzas cortantes para huesos | Página | 494 |
| Pinces coupantes à os | Page | 494 |
| Pinze taglienti per ossa | Pagina | 494 |

Instrumente für Knochenchirurgie
 Instruments for Bone Surgery
 Instrumentos para cirugía ósea
 Instruments pour chirurgie osseuse
 Strumenti per chirurgia ossea



| | | |
|----------------------------------|--------|-----|
| Rundmeißelzange | Seite | 494 |
| Rib Rongeur | Page | 494 |
| Pinza-gubia para redondear | Página | 494 |
| Rongeurs | Page | 494 |
| Pinze costali | Pagina | 494 |



| | | |
|------------------------|--------|-----|
| Hohlmeißelzangen | Seite | 494 |
| Rib Rongeurs | Page | 494 |
| Pinzas-gubias | Página | 494 |
| Pinces-gouges | Page | 494 |
| Pinze costali | Pagina | 494 |



| | | |
|------------------------------|--------|-----------|
| Rippenraspatorien | Seite | 495 - 497 |
| Rib Raspatories | Page | 495 - 497 |
| Periostótomos costales | Página | 495 - 497 |
| Rugines costales | Page | 495 - 497 |
| Periostotomi costali | Pagina | 495 - 497 |





Amputation
Amputation
Amputación
Amputation
Amputazione



1/4

47-0240

Komprimeter zur Erzeugung einer Blutleere in den Extremitäten, Manometer mit Meßbereich bis 700 mm Hg, komplett, bestehend aus:

47-0241 1 Luftpumpe mit Manometer
47-0243 1 Oberschenkel-Manschette
47-0244 1 Oberarm-Manschette

Comprimeter. Compression apparatus for producing exsanguination in the extremities. Manometer registers up to 700 mm Hg. Complete, consisting of:

47-0241 1 Pump with manometer
47-0243 1 Cuff for the leg
47-0244 1 Cuff for the upper arm

Torniquete para producir una isquemia local en las extremidades. Manómetro ajustado hasta 700 mm Hg, completo, compuesto de:

47-0241 1 Bomba de aire con manómetro
47-0243 1 Brazaletes para el muslo
47-0244 1 Brazaletes para el brazo

Appareil compressif permettant de créer une ischémie dans les extrémités. Manomètre ajusté jusqu'à 700 mm Hg. Complet, composé de:

47-0241 1 Pompe à air avec manomètre
47-0243 1 Manchette pour le bras
47-0244 1 Manchette pour la cuisse

Apparecchio per arrestare il sangue nelle estremita. Manometro graduato fino a 700 mm Hg.

Completo, composto da:
47-0241 1 Pompa aria con manometro
47-0243 1 Bracciale
47-0244 1 Cosciale



1/2

ESMARCH

47-0245

Staubinde, 5 m lang, 6 cm breit
Compression bandage, 5 m long, 6 cm wide
Venda-compresión, 5 m largo, 6 cm ancho
Bande compressive, 5 m long, 6 cm de large
Fascia per ischemia 5 m x 6 cm



1/4

ESMARCH

47-0248

Stauschlauch, 1 m lang
Compression tube, 1 m long
Tubo-compresión, 1 m largo
Tube compressie, 1 m de long
Tubo per ischemia da 1 m

Amputationsretraktoren
Amputation Retractors
Retradores para amputación
Retracteurs
Retratore per amputazione



PERCY
47-0290

Griffe abnehmbar
Removable handles
Mangos desmontables
Manches démontables
Manici smontabili

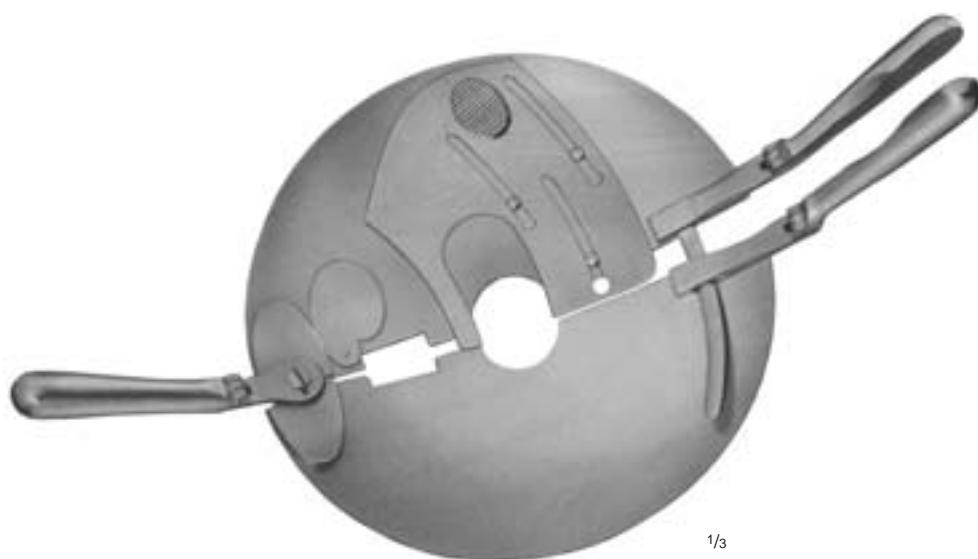

PERCY
47-0291

Griffe umlegbar
Reversible handles
Mangos reversibles
Manches reversibles
Manici reversibili



Amputations- und Resektionssägen
Amputation and Resection Saws
Sierras para amputación y resección
Scies à amputation et résection
Seghe per amputazione e resezione

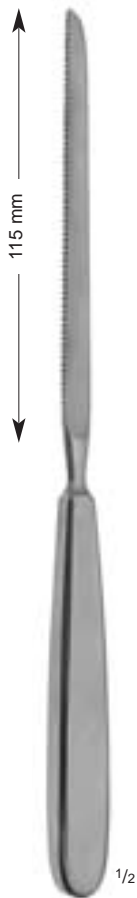

LANGENBECK
47-0300
23,5 cm, 9 1/4"

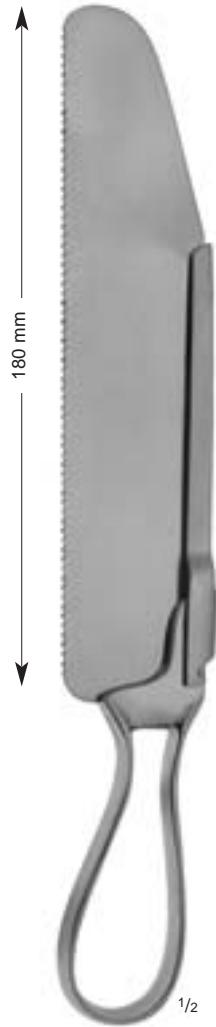

CHARRIÈRE
47-0305
27 cm, 10 3/4"

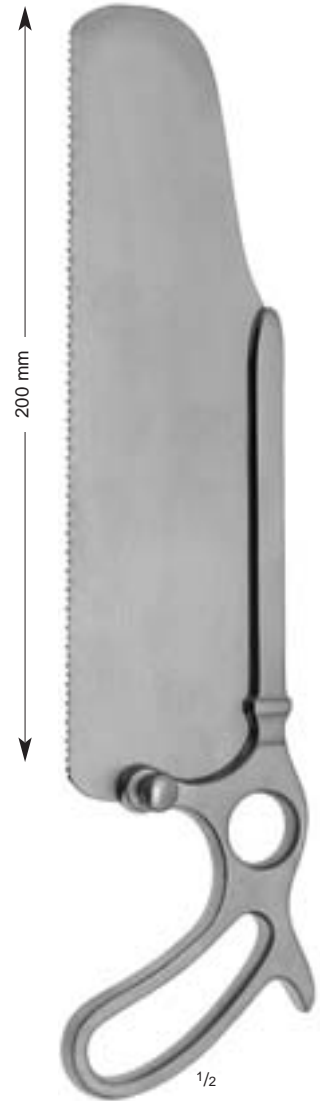

SATTERLEE
47-0310
29 cm, 11 1/2"

mit austauschbarem

Sägeblatt (47-0311)

with interchangeable
saw blade (47-0311)

con hoja de sierra
intercambiable (47-0311)

avec lame interchange-
able (47-0311)

con lama intercambi-
abile (47-0311)

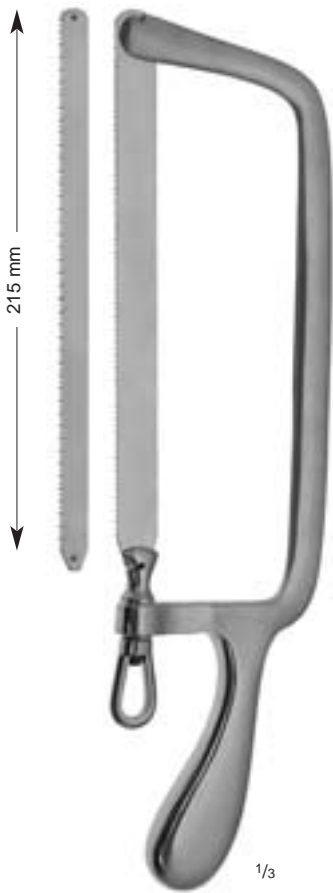

CHARRIÈRE

47-0315

35 cm, 13^{3/4}"

mit je 1 austauschbarem Sägeblatt
 12 mm (47-0316) und 18 mm (47-0317)

with 1 each interchangeable saw blade
 12 mm (47-0316) and 18 mm (47-0317)

con 2 hojas de sierras intercambiables
 12 mm (47-0316) y 18 mm (47-0317)

avec 1 jeu de 2 lames de scie 12 mm
 (47-0316) et 18 mm (47-0317)

con 2 lame intercambiabili 12 mm
 (47-0316) e 18 mm (47-0317)

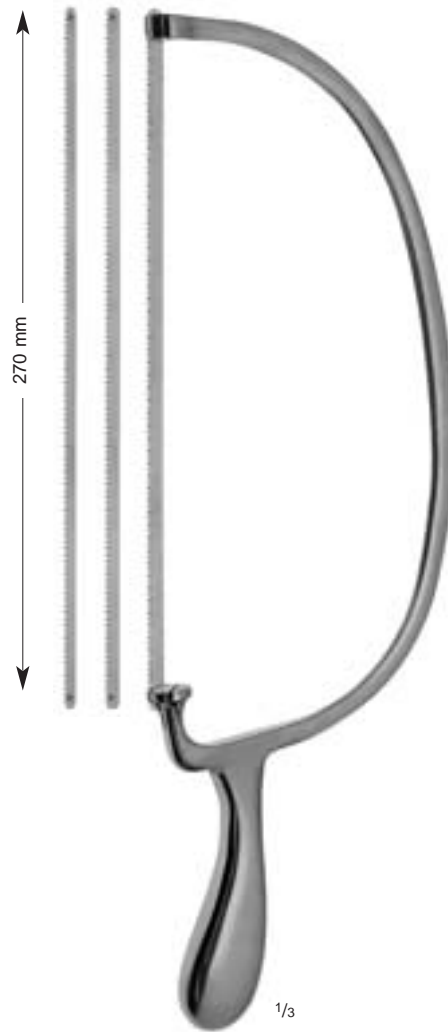

BIER

47-0320

40,5 cm, 16"

mit je 1 austauschbarem Sägeblatt 4 mm
 (47-0321), 6 mm (47-0322) und 8 mm (47-0323)

with 1 each interchangeable saw blade 4 mm
 (47-0321), 6 mm (47-0322) and 8 mm (47-0323)

con 3 hojas de sierras intercambiables 4 mm
 (47-0321), 6 mm (47-0322) y 8 mm (47-0323)

avec 1 jeu de 4 lames de scies 4 mm (47-0321),
 6 mm (47-0322) et 8 mm (47-0323)

con 3 lame intercambiabili 4 mm (47-0321),
 6 mm (47-0322) e 8 mm (47-0323)

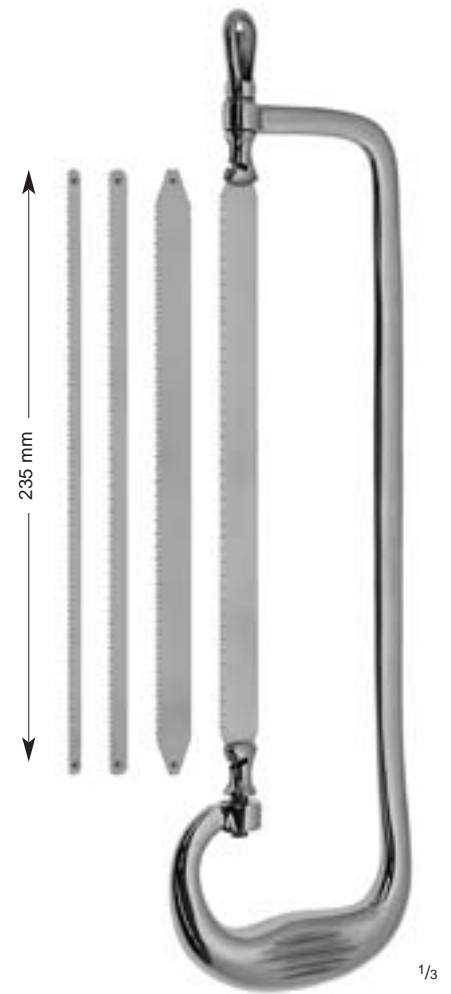

RUST

47-0330

39 cm, 15^{1/2}"

mit je 1 austauschbarem Sägeblatt 6 mm (47-0331),
 8 mm (47-0332), 15 mm (47-0334) und 18 mm (47-0335)

with 1 each interchangeable saw blade 6 mm (47-0331),
 8 mm (47-0332), 15 mm (47-0334) and 18 mm (47-0335)

con 4 hojas de sierras intercambiables 6 mm (47-0331),
 8 mm (47-0332), 15 mm (47-0334) y 18 mm (47-0335)

avec 1 jeu de 4 lames de scies 6 mm (47-0331), 8 mm
 (47-0332), 15 mm (47-0334) et 18 mm (47-0335)

con 4 lame intercambiabili 6 mm (47-0331), 8 mm
 (47-0332), 15 mm (47-0334) e 18 mm (47-0335)



Dissektoren
Dissectors
Disecadores
Dissecteurs
Dissettori

Elevatorien
Elevators
Elevadores
Elévateurs
Elevatori

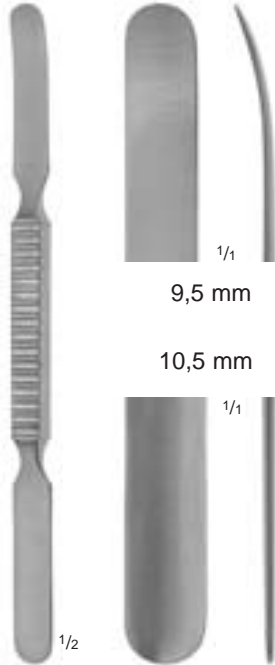

WATSON-CHEYNE
48-0170
17,5 cm, 7"

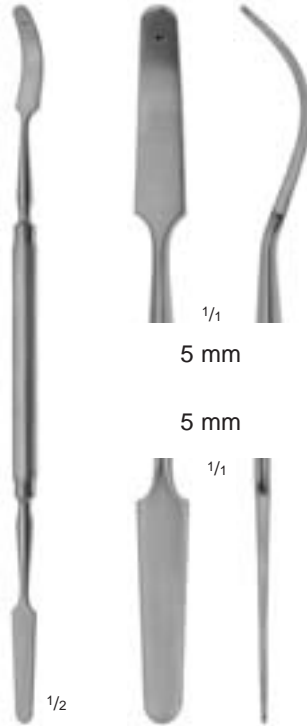

MC DONALD
48-0177
19 cm, 7 1/2"

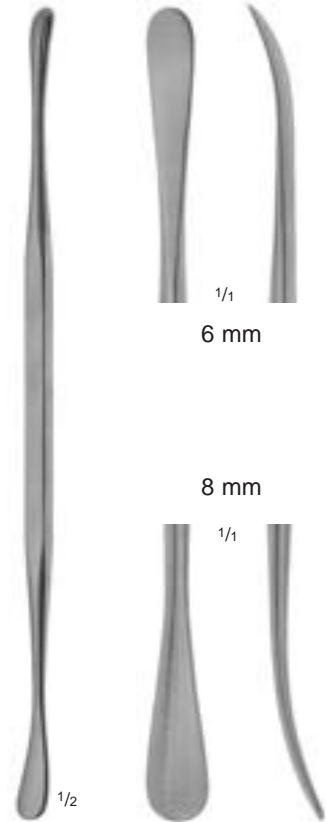

ALDERDYCE
81-0125
21,5 cm, 8 1/2"

Dissektoren • Dissectors • Disecadores • Dissecteurs • Dissettori

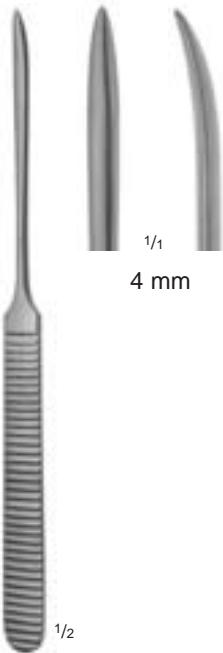

WILLIGER
48-0090
17 cm, 6 3/4"

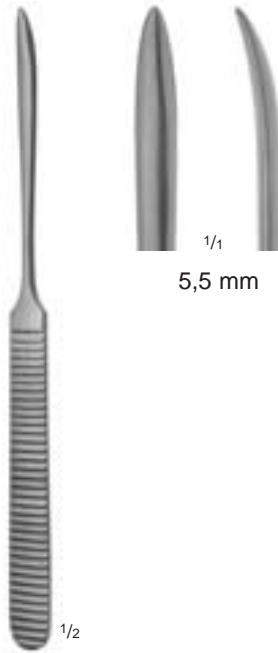

WILLIGER
48-0091
17 cm, 6 3/4"

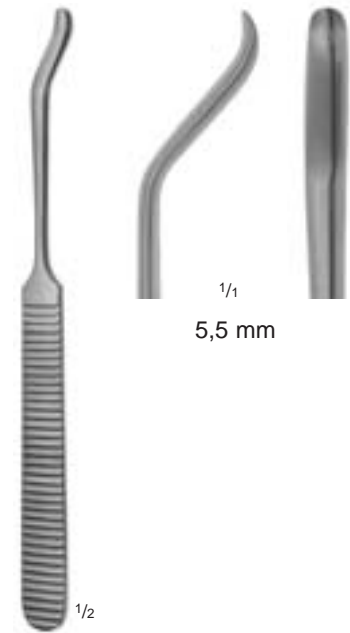

48-0087
16,5 cm, 6 1/2"

Elevatorien • Elevators • Elevadores • Elévateurs • Elevatori

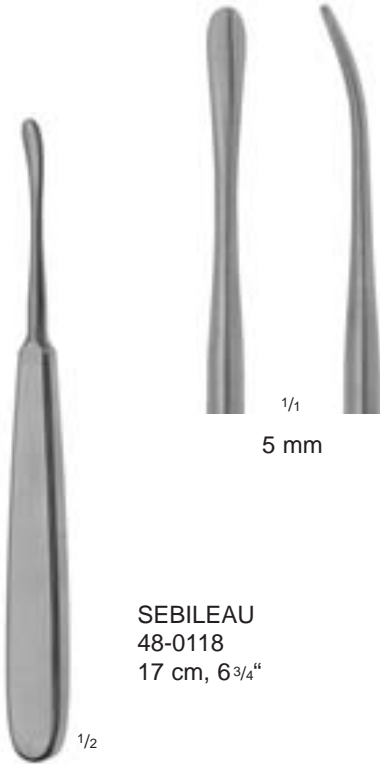

SEBILEAU
48-0118
17 cm, 6^{3/4}"

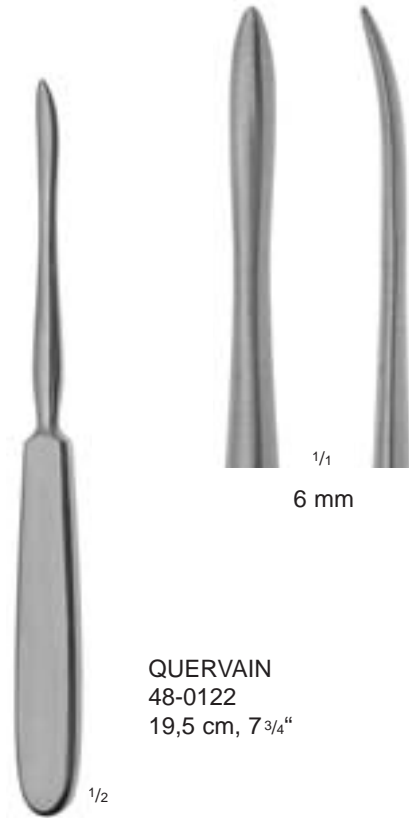

QUERVAIN
48-0122
19,5 cm, 7^{3/4}"

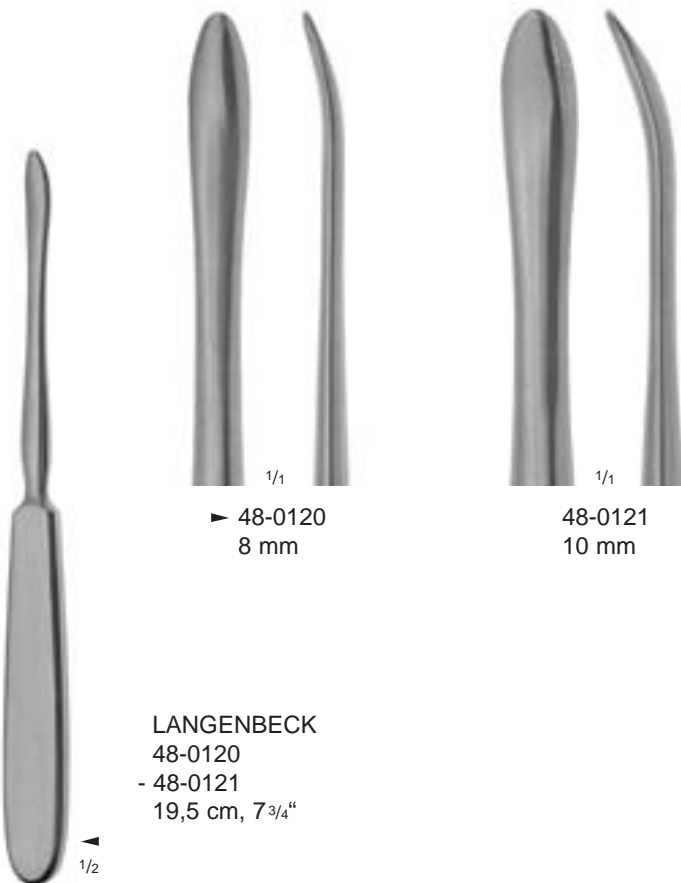

▶ 48-0120
8 mm

48-0121
10 mm

LANGENBECK
48-0120
- 48-0121
19,5 cm, 7^{3/4}"

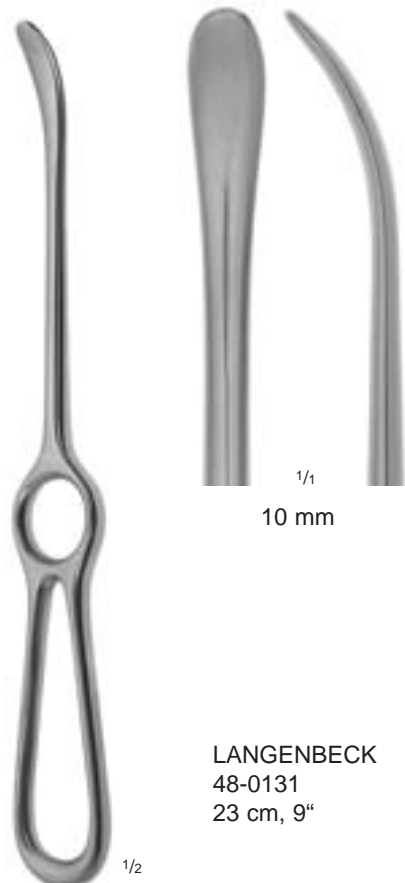

10 mm

LANGENBECK
48-0131
23 cm, 9"



Knochenhebel
 Bone Levers
 Elevadores para huesos
 Leviers à os
 Leve per ossa

3 mm

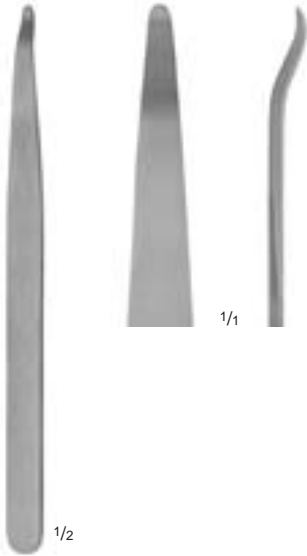

48-0070
 14,5 cm, 5³/₄"

6 mm

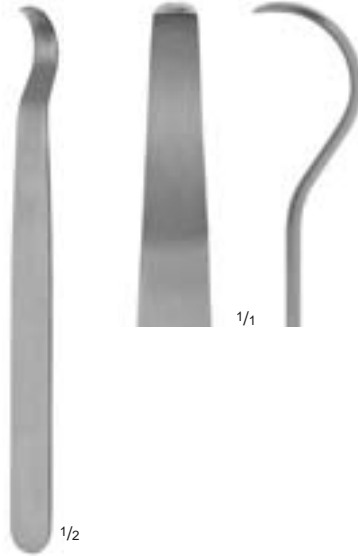

48-0072
 14,5 cm, 5³/₄"

7 mm

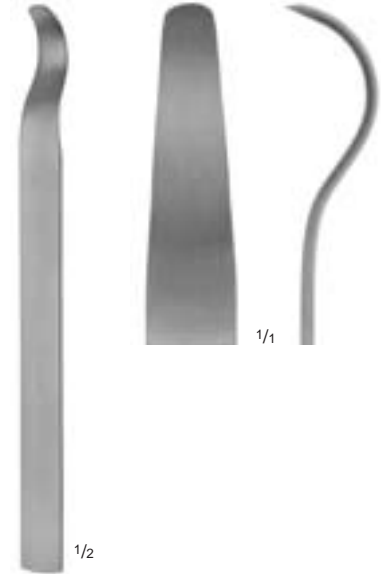

48-0075
 15 cm, 6"

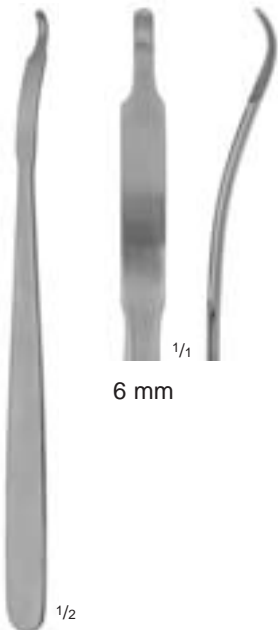

MINI-HOHMANN
 45-0302
 16 cm, 6¹/₄"

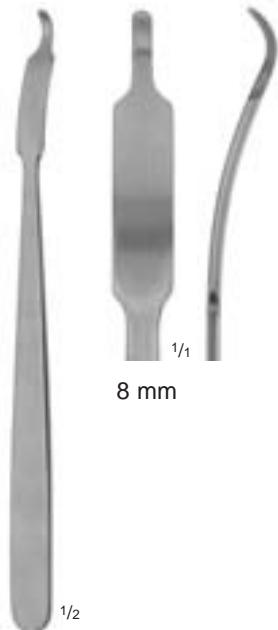

MINI-HOHMANN
 45-0304
 16 cm, 6¹/₄"

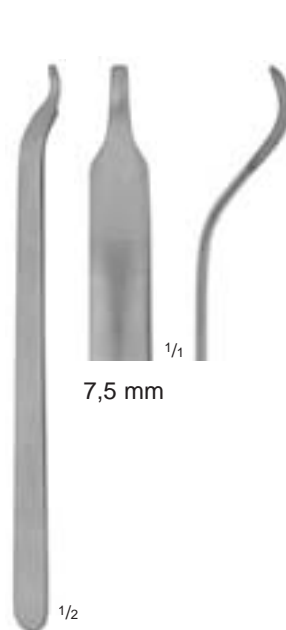

BUCK-GRAMCKO
 45-0306
 15 cm, 6"

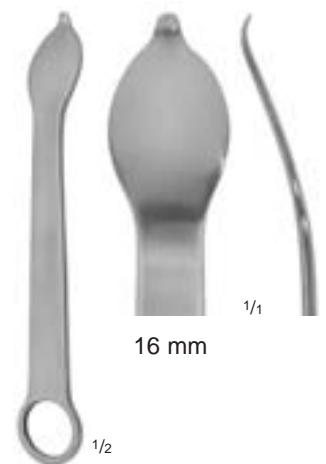

45-0308
 12 cm, 4³/₄"



17 mm



24 mm



30 mm



WAGNER
 45-0316
 22 cm, 8³/₄"



LANGE-HOHMANN
 45-0312
 25,5 cm, 10"



LANGE-HOHMANN modif.
 45-0314
 26,5 cm, 10¹/₂"



Knochenhebel
Bone Levers
Elevadores para huesos
Leviers à os
Leve per ossa



9 mm



18 mm



18 mm



24 mm



HOHMANN
45-0319
22 cm, 8³/₄"



HOHMANN
45-0317
24 cm, 9¹/₂"



HOHMANN
45-0320
25,5 cm, 10"



HOHMANN
45-0322
26 cm, 10¹/₄"



35 mm



43 mm



64 mm



HOHMANN
45-0323
28,5 cm, 11 1/4"



VERBRUGGE-MÜLLER
45-0324
24 cm, 9 1/2"



VERBRUGGE-MÜLLER
45-0325
25,5 cm, 10"



Knochenhebel
Bone Levers
Elevadores para huesos
Leviers à os
Leve per ossa

Hüfthebel
Hib Levers
Elevadores para caderas
Elevateurs pour la hanche
Leve per sciatica



25 mm



24 mm



34 mm



45 mm



HOHMANN
45-0326
27 cm, 10³/₄"

Knochenhebel
Bone lever
Elevador para hueso
Levier à os
Leve per ossa



HOHMANN-ALDINGER
45-0318
28,5 cm, 11¹/₄"

Knochenhebel
Bone lever
Elevador para hueso
Levier à os
Leve per ossa



BLOUNT
45-0328
26 cm, 10¹/₄"

Hüfthebel
Hib lever
Elevador para cadera
Elevateur pour la hanche
Leve per sciatica



BLOUNT
45-0329
26 cm, 10¹/₄"

Hüfthebel
Hib lever
Elevador para cadera
Elevateur pour la hanche
Leve per sciatica

Knochenhebel
 Bone Levers
 Elevadores para huesos
 Leviers à os
 Leve per ossa

Luxationshebel
 Luxation Lever
 Elevadores para luxación
 Leviers pour luxation
 Leve per lussazione



45-0330
 45 mm

1/1



▶ 45-0331
 60 mm

1/1



1/2

BENNETT
 45-0330
 - 45-0331
 25 cm, 10"

Knochenhebel
 Bone levers
 Elevadores para huesos
 Leviers à os
 Leve per ossa



30 mm

1/1



18 mm

1/1



30 mm

18 mm

1/2

MURPHY-LANE
 45-0310
 30 cm, 12"

Luxationshebel
 Luxation lever
 Elevador para luxación
 Levier pour luxation
 Leve per lussazione



Raspatorien
 Raspatories
 Periostótomos
 Rugines-raspatoires
 Periostotomi

4 mm

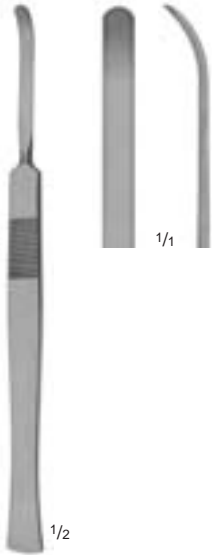

MC KENTY
 71-0450
 14,5 cm, 5³/₄"

5 mm

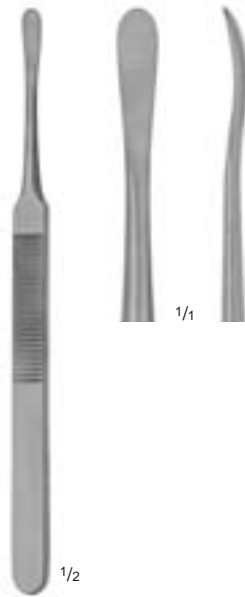

KÖNIG
 48-0105
 15,5 cm, 6"

4 mm

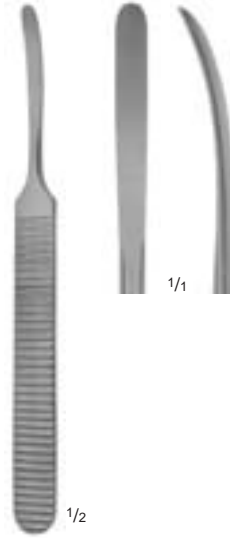

WILLIGER
 48-0107
 14 cm, 5¹/₂"

6 mm

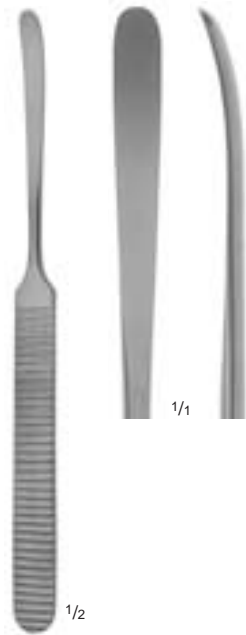

WILLIGER
 48-0108
 16 cm, 6¹/₄"

8 mm

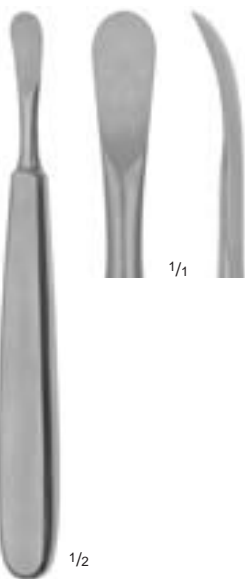

TRELAT
 48-0110
 15 cm, 6"

4 mm

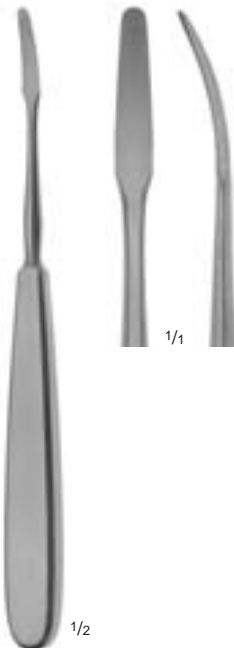

JOSEPH
 77-0760
 17 cm, 6³/₄"

3 mm

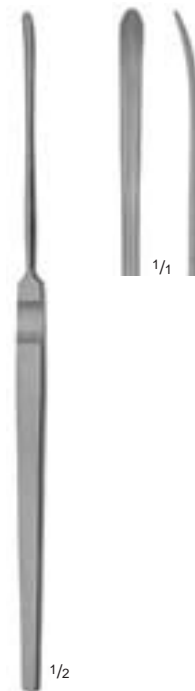

HALLE
 71-0490
 18 cm, 7"

6 mm



SEWALL
 71-0493
 20 cm, 8"



4,5 mm

stumpf
blunt
romo
mousse
smusso

scharf
sharp
agudo
pointu
acuto

4,5 mm

FREER
63-2920
19,5 cm, 7³/₄"

6,5 mm

stumpf
blunt
romo
mousse
smusso

scharf
sharp
agudo
pointu
acuto

6,5 mm

FREER
63-2925
19,5 cm, 7³/₄"

4,5 mm

stumpf
blunt
romo
mousse
smusso

scharf
sharp
agudo
pointu
acuto

4,5 mm

FREER
71-0415
19,5 cm, 7³/₄"

4,5 mm

scharf
sharp
agudo
pointu
acuto

4,5 mm

FREER
71-0416
19,5 cm, 7³/₄"

3,5 mm

stumpf
blunt
romo
mousse
smusso

scharf
sharp
agudo
pointu
acuto

3,5 mm

KILLIAN
71-0441
18,5 cm, 7¹/₄"

4,5 mm

4,5 mm

KILLIAN
71-0440
19 cm, 7¹/₂"

5,5 mm

4,5 mm

HOWARD
48-0172
21,5 cm, 8¹/₂"

4,5 mm

4,5 mm

COTTLE
71-0516
23 cm, 9"



Raspatorien
 Raspatories
 Periostótomos
 Rugines-raspatoires
 Periostotomi

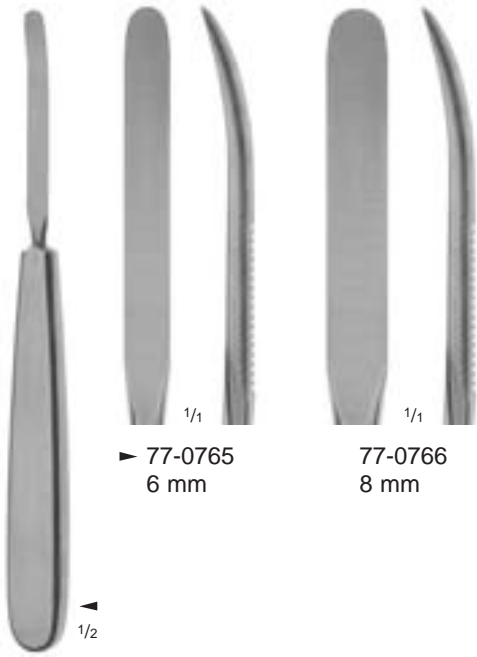

▶ 77-0765
 6 mm

77-0766
 8 mm

77-0765
 - 77-0766
 17 cm, 6³/₄"

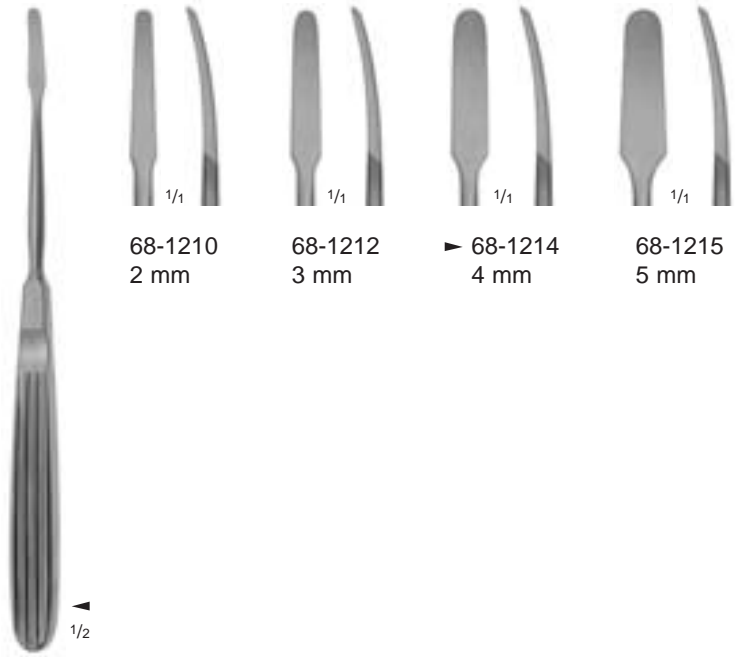

68-1210
 2 mm

68-1212
 3 mm

▶ 68-1214
 4 mm

68-1215
 5 mm

LEMPERT
 68-1210
 - 68-1215
 17 cm, 6³/₄"

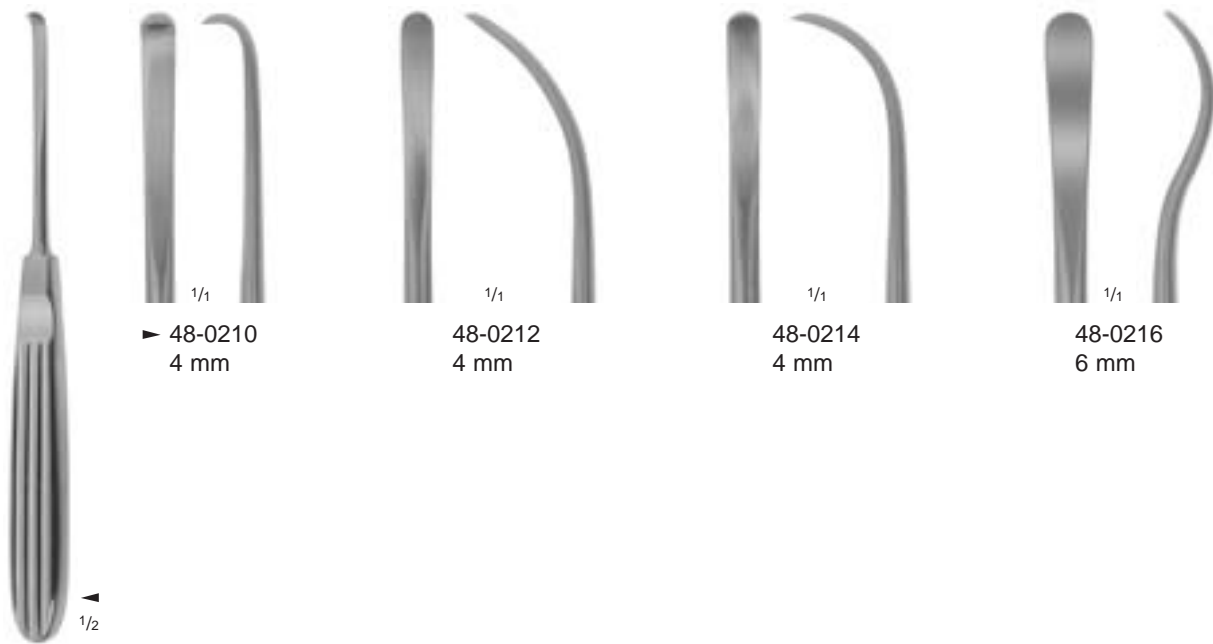

▶ 48-0210
 4 mm

48-0212
 4 mm

48-0214
 4 mm

48-0216
 6 mm

MÜHLING
 48-0210
 - 48-0216
 17 cm, 6³/₄"

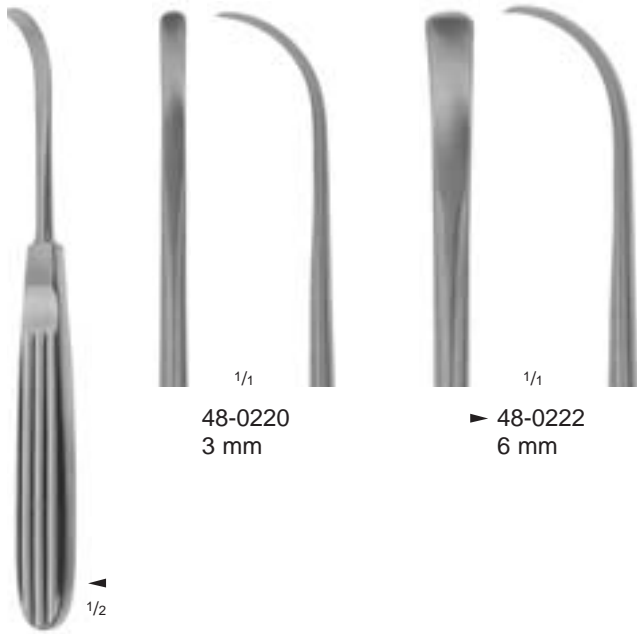

48-0220
 3 mm

▶ 48-0222
 6 mm

48-0220
 - 48-0222
 17 cm, 6^{3/4}"

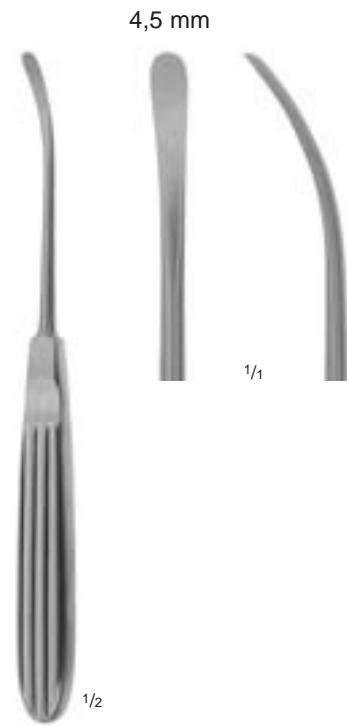

LANDOLT
 48-0218
 17,5 cm, 7"

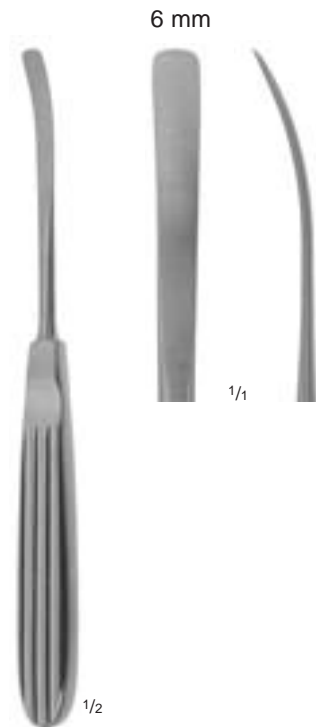

CASPAR
 48-0224
 18 cm, 7"

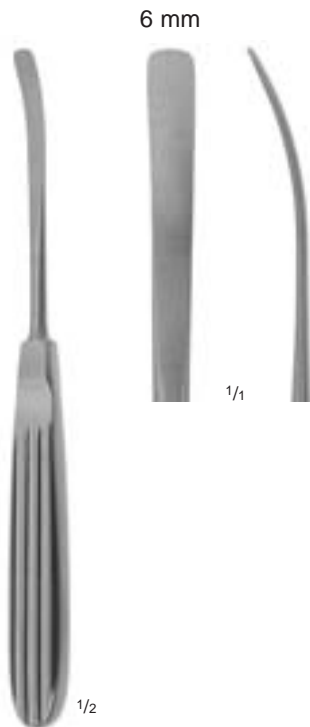

CASPAR
 48-0226
 18 cm, 7"

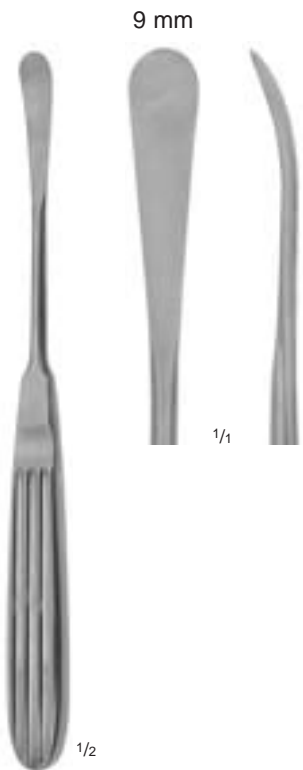

COTTLE
 48-0228
 19 cm, 7^{1/2}"



Raspatorien
 Raspatories
 Periostótomos
 Rugines-raspatoires
 Periostotomi



▶ 52-0100
8 mm



52-0115
7 mm



52-0105
7 mm



52-0110
7 mm

ADSON
 52-0100
 - 52-0115
 17 cm, 6 3/4"

1/2

18 mm



1/1

SEDILLOT
 39-0195
 19 cm, 7 1/2"

1/2

6 mm

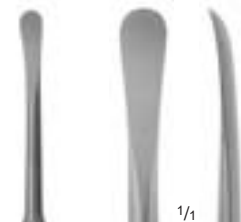

1/1



1/2

HOEN
 52-0090
 16 cm, 6 1/4"

15 mm



1/1



1/2

HOEN
 52-0091
 19 cm, 7 1/2"

20 mm



1/1



1/2

HOEN
 52-0092
 19 cm, 7 1/2"

15 mm



1/1



1/2

SEDILLOT
 39-0192
 22 cm, 8 3/4"

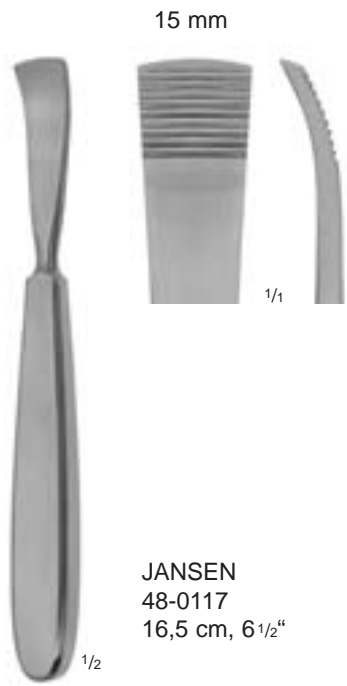

JANSEN
 48-0117
 16,5 cm, 6 1/2"

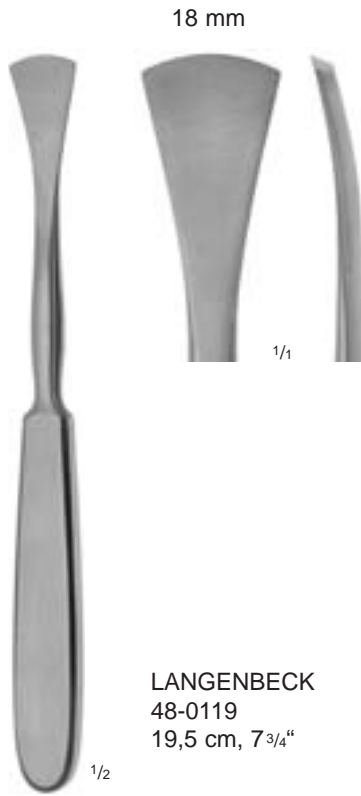

LANGENBECK
 48-0119
 19,5 cm, 7 3/4"

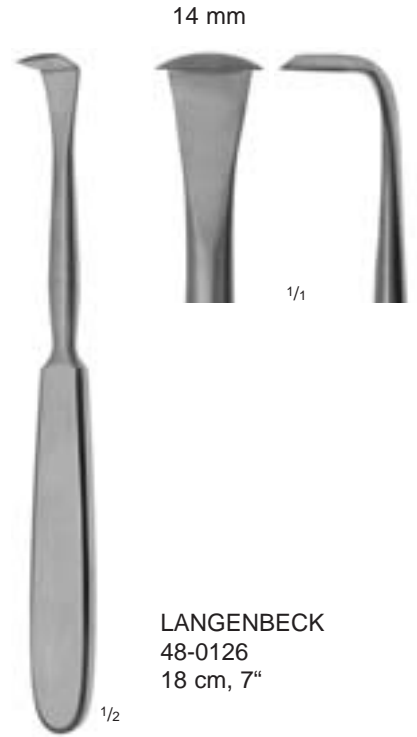

LANGENBECK
 48-0126
 18 cm, 7"

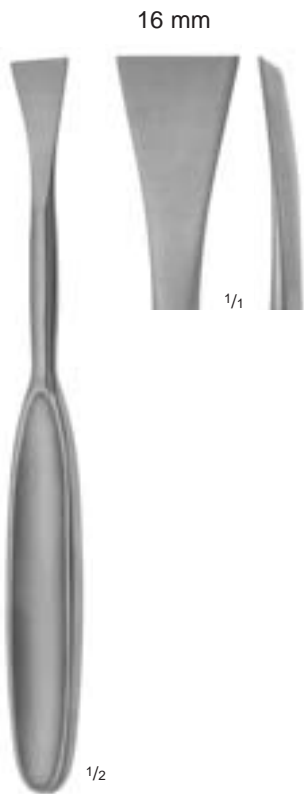

LANGENBECK
 48-0123
 19,5 cm, 7 3/4"

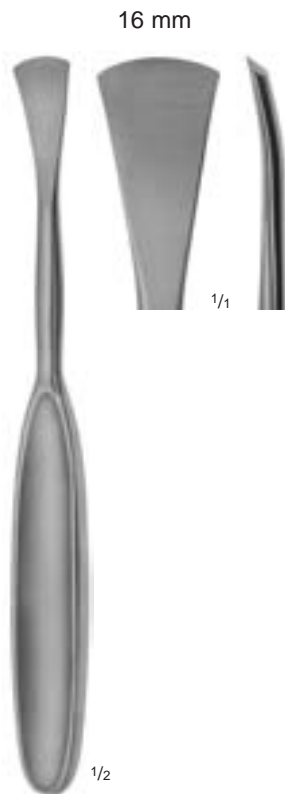

LANGENBECK
 48-0125
 19,5 cm, 7 3/4"

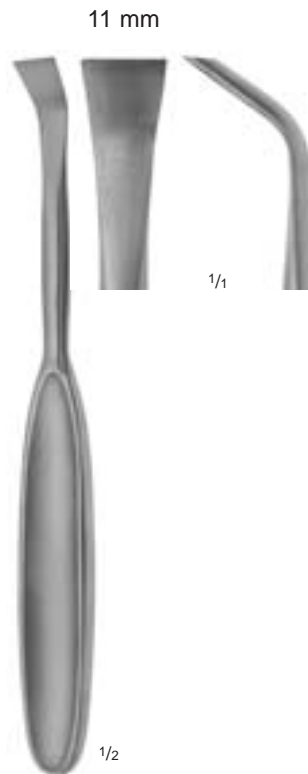

LANGENBECK
 48-0128
 19 cm, 7 1/2"

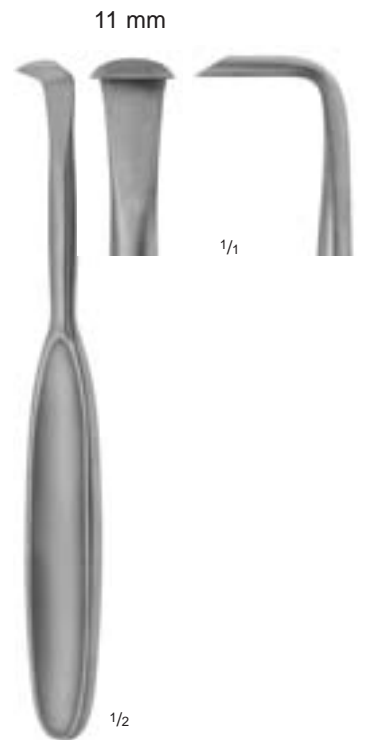

LANGENBECK
 48-0129
 18 cm, 7"



Raspatorien
 Raspatories
 Periostótomos
 Rugines-raspatoires
 Periostotomi

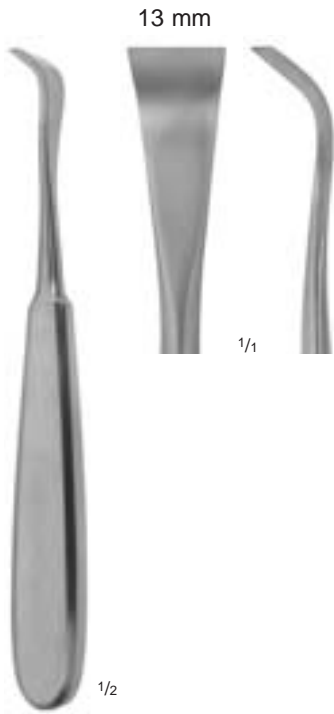

SCHNEIDER
 48-0132
 17,5 cm, 7"

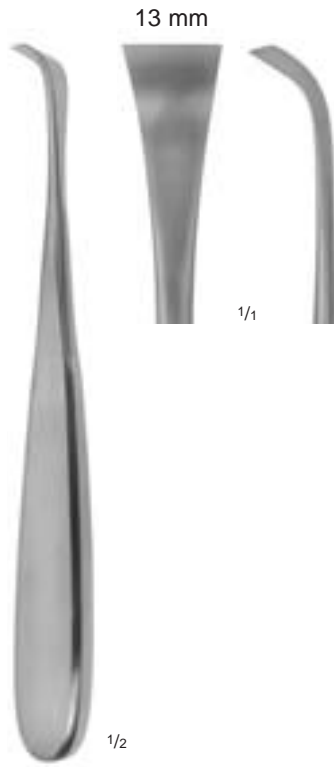

SCHNEIDER-SAUERBRUCH
 48-0134
 19 cm, 7 1/2"

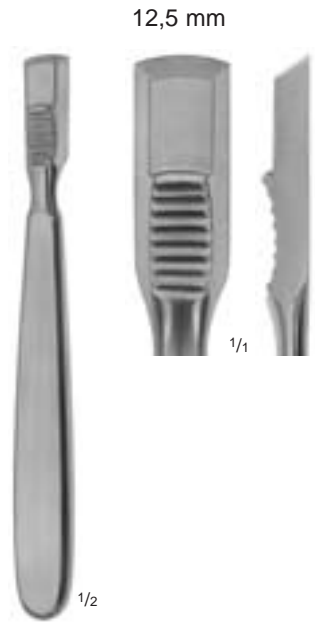

FARABEUF
 48-0142
 15 cm, 6"



FARABEUF
 48-0143
 15 cm, 6"

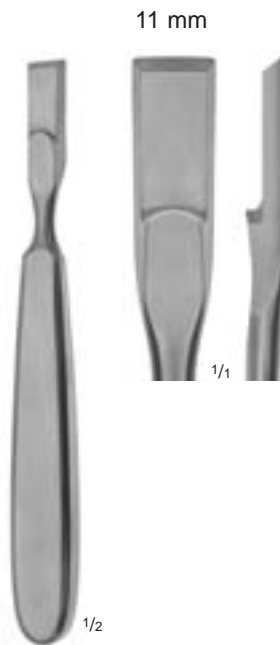

FARABEUF-COLLIN
 48-0148
 15,5 cm, 6"

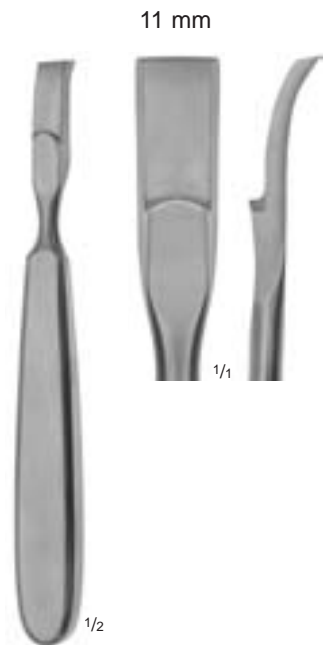

FARABEUF-COLLIN
 48-0149
 15,5 cm, 6"



3,0 mm

48-0200
 17,5 cm, 7"



6,5 mm

48-0201
 17,5 cm, 7"



9,5 mm

48-0202
 19 cm, 7 1/2"



12,5 mm

▶ 48-0203
 19 cm, 7 1/2"



16,0 mm

48-0204
 20 cm, 8"



19,5 mm

48-0205
 20 cm, 8"



24,5 mm

48-0206
 21 cm, 8 1/4"



KEY
 48-0200
 - 48-0206



10,0 mm

46-0710
 28,5 cm, 11 1/4"



13,0 mm

▶ 46-0711
 28,5 cm, 11 1/4"



19,0 mm

46-0712
 28,5 cm, 11 1/4"



25,0 mm

46-0713
 28,5 cm, 11 1/4"



COBB
 46-0710
 - 46-0713



Raspatorien mit Ferrozellgriff
 Raspatories with handle from artificial wood
 Periostótomos con mango de madera artificial
 Rugines-raspatoires avec manche en „Ferozell“
 Periostotomi con manico in legno artificiale

6 mm



48-0138
19 cm, 7 1/2"

3 mm



48-0141
19 cm, 7 1/2"

6 mm



48-0147
19 cm, 7 1/2"

6 mm



48-0146
19 cm, 7 1/2"

12 mm



48-0151
19,5 cm, 7 3/4"

13 mm



48-0152
20,5 cm, 8"

13 mm



48-0153
20 cm, 8"

20 mm



48-0154
20,5 cm, 8"

Raspatorien mit Ferrozellgriff
 Raspatories with handle from artificial wood
 Periostótomos con mango de madera artificial
 Rugines-raspatoires avec manche en „Ferozell“
 Periostotomi con manico in legno artificiale

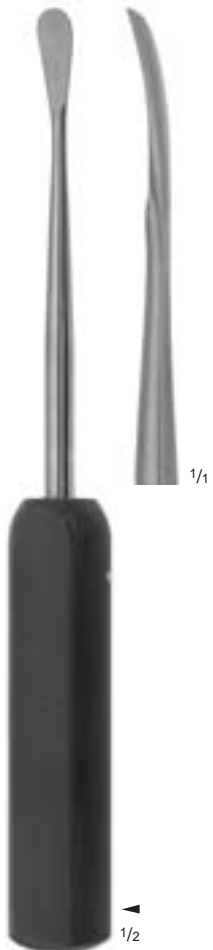
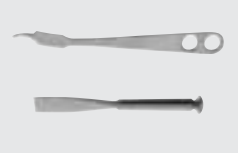

COBB
 48-0156
 - 48-0159
 25 cm, 10"

Sterilisierbar im Autoklav bei 3 bar Überdruck (143°C) !
 Can be autoclaved at 3 bar overpressure (143°C) !
 Esterilizables en autoclave a 3 bar sobrepresión (143°C) !
 Stérilisables à l'autoclave à 3 bars (143°)
 Può'essere autoclavato a 3 bar di pressione (143°)



48-0174
 27,5 cm, 10³/₄"

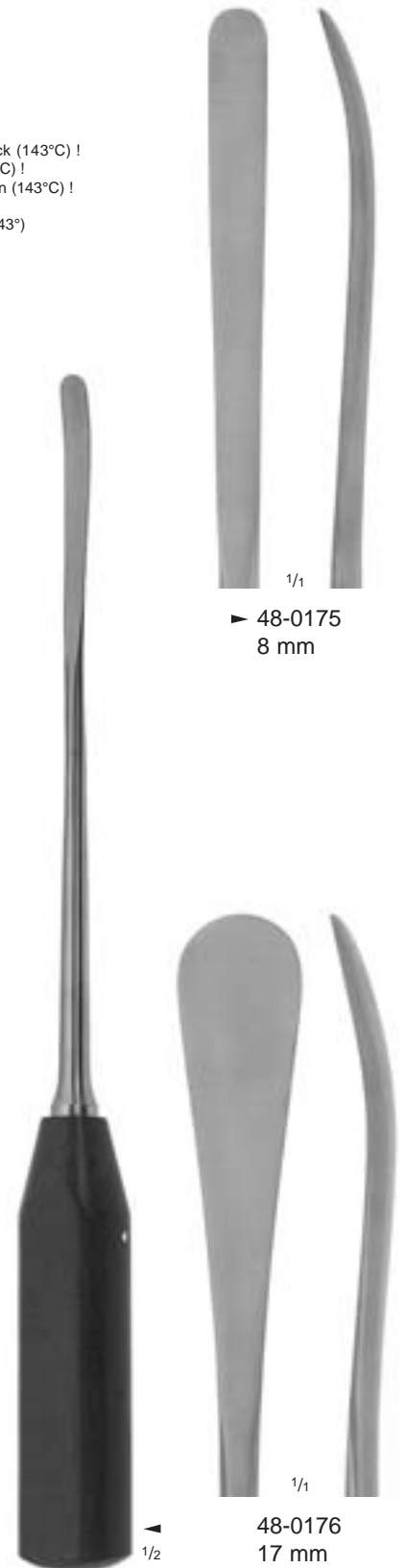

WAGNER
 48-0175
 - 48-0176
 33 cm, 13"



Knochenfeilen
 Bone Files
 Limas para huesos
 Limes à os
 Lime per ossa

Raspeln
 Rasps
 Escofinas
 Râpes
 Raspe



JOSEPH
 77-0400
 16,5 cm, 6 1/2"



GALLAHER
 77-0450
 17 cm, 6 3/4"

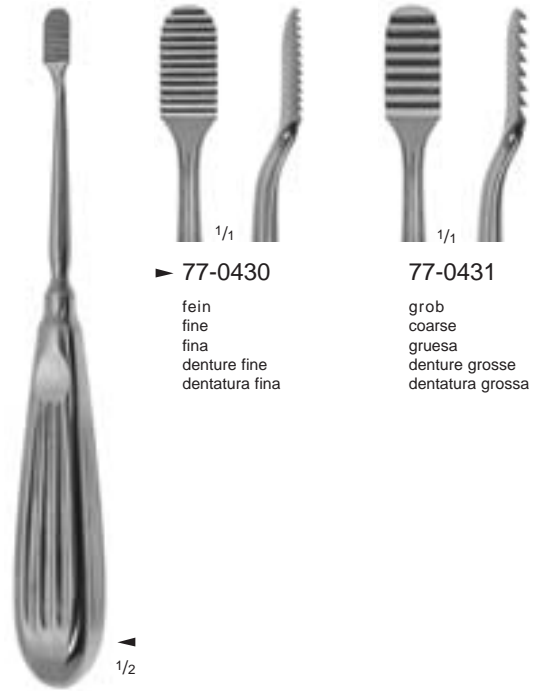

► 77-0430

fein
 fine
 fina
 denture fine
 dentatura fina

77-0431

grob
 coarse
 gruesa
 denture grosse
 dentatura grossa

LEWIS
 77-0430
 - 77-0431
 18 cm, 7"



MILLER
 47-0230
 - 47-0232
 18 cm, 7"



► 47-0231



47-0230



47-0232





MALTZ
77-0440
18 cm, 7"



COTTLE
77-0410
21 cm, 8 1/4"

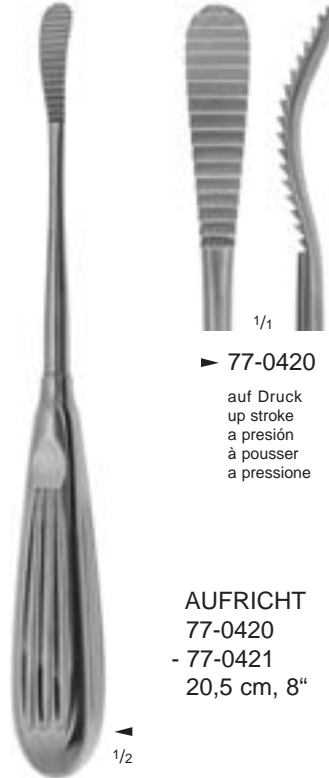

▶ 77-0420
auf Druck
up stroke
a presión
à pousser
a pressione

77-0421
auf Zug
down stroke
a tracción
à tirer
a trazione

AUFRICHT
77-0420
- 77-0421
20,5 cm, 8"



WIENER
70-0960
19,5 cm, 7 3/4"



WIENER
70-0963
19,5 cm, 7 3/4"



BRAWLEY
70-0965
19,5 cm, 7 3/4"



WATSON-
WILLIAMS
70-0967
22 cm, 8 3/4"



Knochenfeilen
Bone Files
Limas para huesos
Limes à os
Lime per ossa

Raspeln
Rasps
Escofinas
Râpes
Raspe



20 mm

18 mm

1/2

PUTTI
47-0210
27 cm, 10 3/4"



10 mm

16 mm

1/2

PUTTI
47-0211
30 cm, 12"

13 mm



1/2

47-0200
24,5 cm, 9 3/4"



20 mm

1/2

47-0217
28,5 cm, 11 1/4"

Knochenfeilen
 Bone Files
 Limas para huesos
 Limes à os
 Lime per ossa

Raspeln
 Rasps
 Escofinas
 Râpes
 Raspe



20 mm



47-0218
 22 cm, 8 3/4"

Feilenhieb / Raspelhieb
 file cut / rasp cut
 filo de lima / filo de escofina
 coupe lime / coupe râpe
 taglio di lima / taglio di raspa

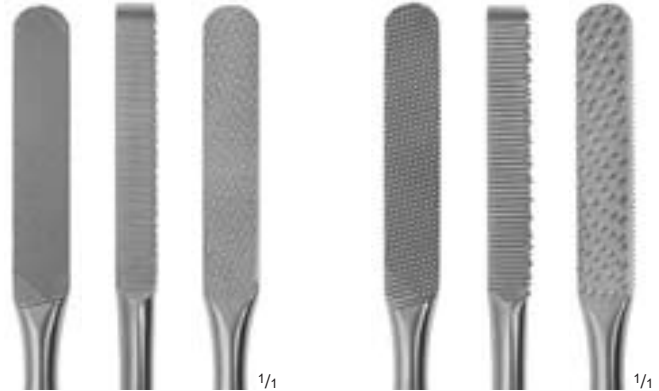

77-0350

fein
 fine
 fina
 denture fine
 dentatura fina

▶ 77-0355

grob
 coarse
 gruesa
 denture grosse
 dentatura grossa



FOMON
 77-0350
 - 77-0355
 21,5 cm, 8 1/2"

Feilenhieb / Raspelhieb
 file cut / rasp cut
 filo de lima / filo de escofina
 coupe lime / coupe râpe
 taglio di lima / taglio di raspa

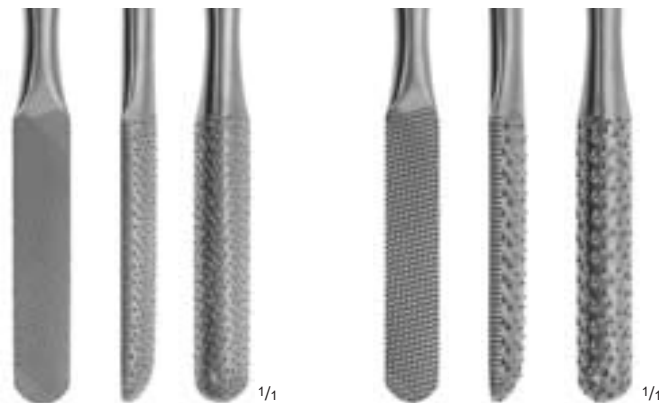



TITE GRIP® Raspeln mit Hartmetalleinlagen
 TITE GRIP® Rasps with tungsten carbide inserts
 TITE GRIP® Escofinas con bocas de carburo tungsteno
 TITE GRIP® Râpes avec mors en tungstène
 TITE GRIP® Raspe con inserti in carburo di tungsteno



1/1

► 77-1330



1/1

77-1332

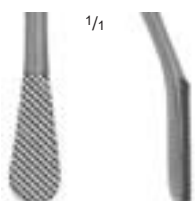

1/1

MILLER
 77-1330
 - 77-1332
 18,5 cm, 7 1/4"



1/1

Fig. 1

► 77-1340

12 Zähne
 12 teeth
 12 dientes
 12 dents
 12 denti



1/1

Fig. 2

77-1341

14 Zähne
 14 teeth
 14 dientes
 14 dents
 14 denti



1/1

Fig. 3

77-1342

16 Zähne
 16 teeth
 16 dientes
 16 dents
 16 denti



1/1

Fig. 4

77-1343

20 Zähne
 20 teeth
 20 dientes
 20 dents
 20 denti



1/1

Fig. 5

77-1344

24 Zähne
 24 teeth
 24 dientes
 24 dents
 24 denti



1/2

MALTZ
 77-1340
 - 77-1349
 21 cm, 8 1/4"



1/1

Fig. 6

77-1345

30 Zähne
 30 teeth
 30 dientes
 30 dents
 30 denti



1/1

Fig. 7

77-1346

36 Zähne
 36 teeth
 36 dientes
 36 dents
 36 denti

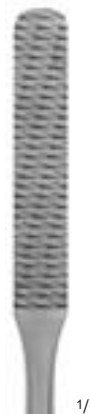

1/1

Fig. 8

77-1347

44 Zähne
 44 teeth
 44 dientes
 44 dents
 44 denti



1/1

Fig. 9

77-1348

52 Zähne
 52 teeth
 52 dientes
 52 dents
 52 denti



1/1

Fig. 10

77-1349

62 Zähne
 62 teeth
 62 dientes
 62 dents
 62 denti

TITE GRIP® Raspeln mit Hartmetalleinlagen
 TITE GRIP® Rasps with tungsten carbide inserts
 TITE GRIP® Escofinas con bocas de carburo tungsteno
 TITE GRIP® Râpes avec mors en tungstène
 TITE GRIP® Raspe con inserti in carburo di tungsteno



Fig. 1



Fig. 3



Fig. 5



Fig. 7



Fig. 9

► 77-1350

12/14 Zähne
 12/14 teeth
 12/14 dientes
 12/14 dents
 12/14 denti

77-1351

16/20 Zähne
 16/20 teeth
 16/20 dientes
 16/20 dents
 16/20 denti

77-1352

24/30 Zähne
 24/30 teeth
 24/30 dientes
 24/30 dents
 24/30 denti

77-1353

36/44 Zähne
 36/44 teeth
 36/44 dientes
 36/44 dents
 36/44 denti

77-1354

52/62 Zähne
 52/62 teeth
 52/62 dientes
 52/62 dents
 52/62 denti



FOMON
 77-1350
 - 77-1354
 20,5 cm, 8"

Fig. 2



Fig. 4



Fig. 6



Fig. 8

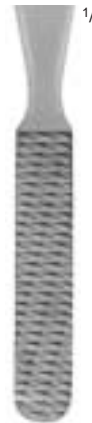

Fig. 10





Scharfe Löffel
 Bone Curettes
 Cucharillas cortantes
 Curettes
 Curette per ossa



HOUSE
66-0158
 15,5 cm, 6"



HOUSE
66-0159
 15 cm, 6"

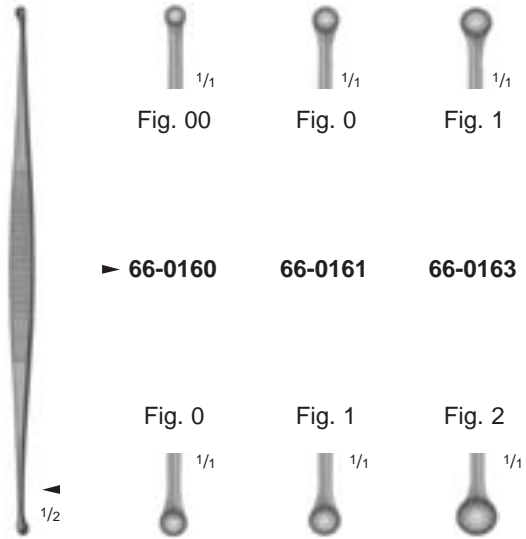

MARTINI
66-0160
 - **66-0163**
 14 cm, 5 1/2"

Fig. 00 Fig. 0 Fig. 1
 ▶ **66-0160** **66-0161** **66-0163**

Fig. 0 Fig. 1 Fig. 2
 1/2 1/1 1/1

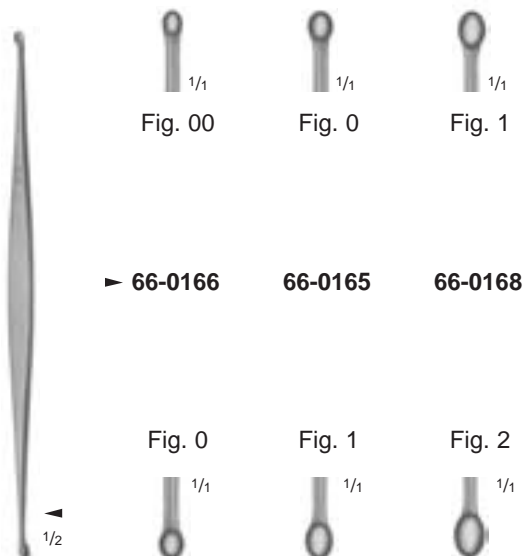

WILLIGER
66-0165
 - **66-0168**
 14 cm, 5 1/2"

▶ **66-0166** **66-0165** **66-0168**

Fig. 0 Fig. 1 Fig. 2
 1/2 1/1 1/1

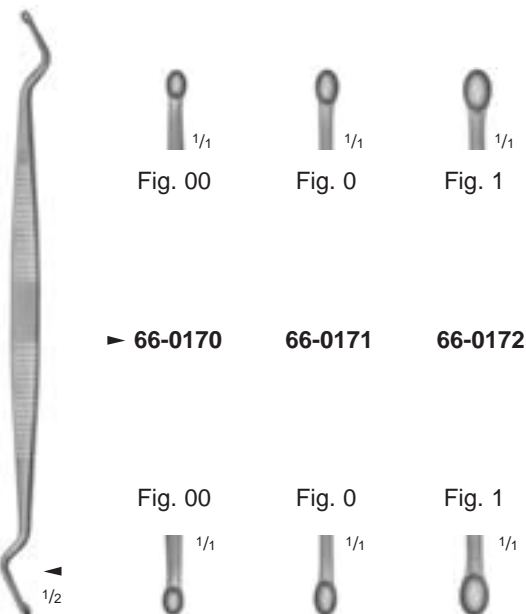

WILLIGER
66-0170
 - **66-0172**
 16 cm, 6 1/4"

▶ **66-0170** **66-0171** **66-0172**

Fig. 00 Fig. 0 Fig. 1
 1/2 1/1 1/1



BARTH
66-0167
 18 cm, 7"



JANSEN
66-0162
 16 cm, 6 1/4"



JANSEN
47-0456
 15,5 cm, 6"



47-0425
 21 cm, 8 1/4"

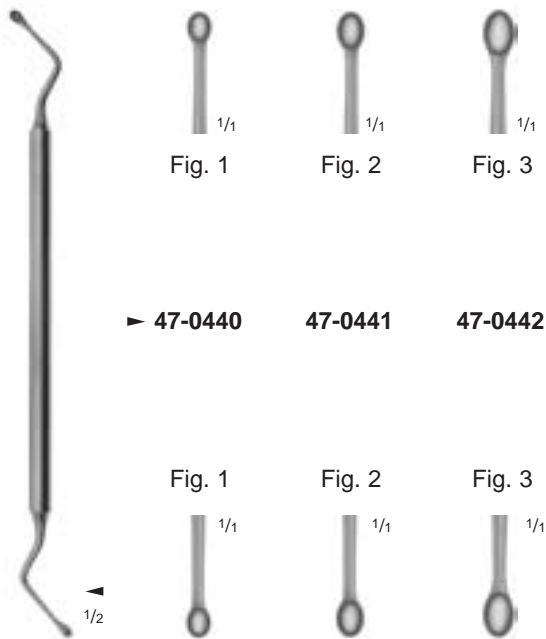

HEMINGWAY
47-0440
 - **47-0442**
 16,5 cm, 6 1/2"

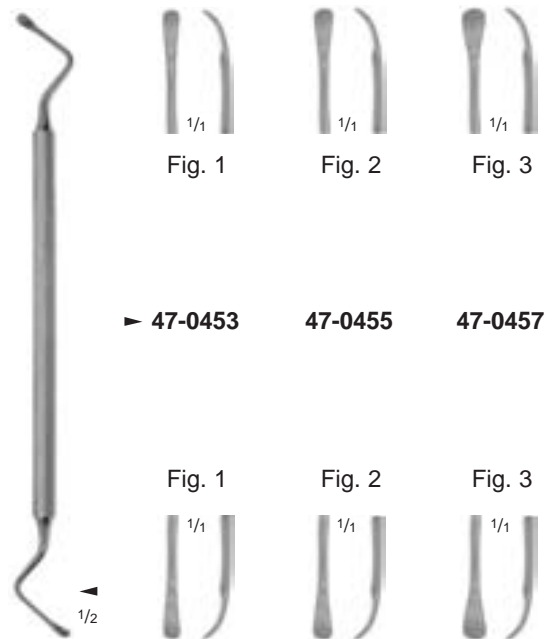

LUCAS
47-0453
 - **47-0457**
 16,5 cm, 6 1/2"



Scharfe Löffel
 Bone Currettes
 Cucharillas cortantes
 Currettes
 Curette per ossa

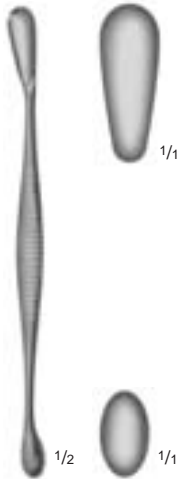

VOLKMANN
47-0400
 12,5 cm, 5"



VOLKMANN
47-0405
 16,5 cm, 6 1/2"



VOLKMANN
47-0410
 20,5 cm, 8"



VOLKMANN
47-0414
 13 cm, 5 1/8"



VOLKMANN
47-0415
 16,5 cm, 6 1/2"



VOLKMANN
47-0416
 20 cm, 8"



WILLIGER
47-0420
 - **47-0423**
 17,5 cm, 7"

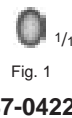
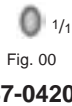

WILLIGER
47-0426
 - **47-0429**
 17,5 cm, 7"

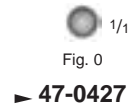

Scharfe Löffel
 Bone Currettes
 Cucharillas cortantes
 Currettes
 Curette per ossa



UFFENORDE
47-0430
 17 cm, 6³/₄"



UFFENORDE
47-0431
 17 cm, 6³/₄"



MOD. USA
47-0461
 - **47-0466**
 16 cm, 6¹/₄"

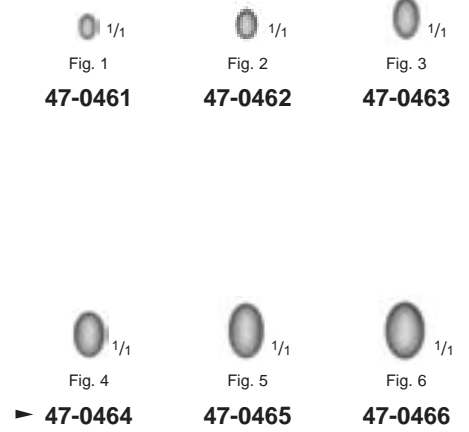

MOD. USA
47-0471
 - **47-0476**
 15,5 cm, 6"

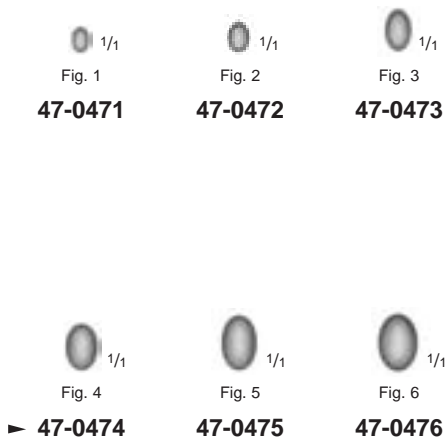

MOD. USA
47-0481
 - **47-0486**
 15,5 cm, 6"

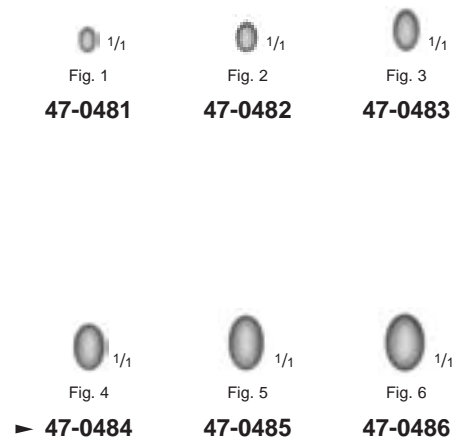



Scharfe Löffel
 Bone Curettes
 Cucharillas cortantes
 Curettes
 Curette per ossa

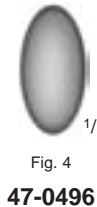
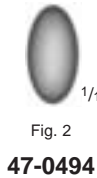
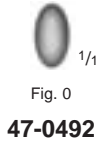

SCHUDE
47-0490
 - **47-0496**
 17,5 cm, 7"

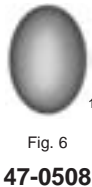
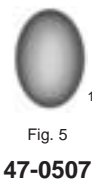
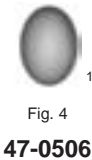
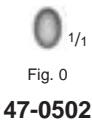
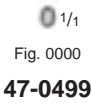

SPRATT
47-0499
 - **47-0508**
 17 cm, 6³/₄"

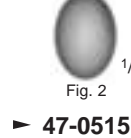

VOLKMANN
47-0510
 - **47-0519**
 17 cm, 6³/₄"

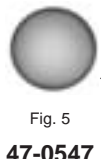
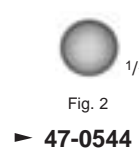

BRUNS
47-0539
 - **47-0548**
 17 cm, 6³/₄"



Fig. 000

47-0520



Fig. 00

47-0521



Fig. 0

47-0522



Fig. 1

47-0523



Fig. 2

47-0524



Fig. 3

▶ **47-0525**



Fig. 4

47-0526



Fig. 5

47-0527



Fig. 6

47-0528



BRUNS
47-0520
 - **47-0528**
 23 cm, 9"



Fig. 000

47-1520



Fig. 00

47-1521



Fig. 0

47-1522



Fig. 1

47-1523



Fig. 2

47-1524



Fig. 3

▶ **47-1525**



Fig. 4

47-1526



Fig. 5

47-1527



Fig. 6

47-1528



BRUNS
47-1520
 - **47-1528**
 22,5 cm, 9"



Fig. 000

47-0530



Fig. 00

47-0531



Fig. 0

47-0532



Fig. 1

47-0533



Fig. 2

47-0534



Fig. 3

▶ **47-0535**



Fig. 4

47-0536



Fig. 5

47-0537



Fig. 6

47-0538



BRUNS
47-0530
 - **47-0538**
 23 cm, 9"



Scharfe Löffel
 Bone Currettes
 Cucharillas cortantes
 Curettes
 Curette per ossa



- Fig. 00000 $\frac{1}{1}$ **68-0310**
- Fig. 0000 $\frac{1}{1}$ **68-0311**
- Fig. 000 $\frac{1}{1}$ **68-0312**
- Fig. 00 $\frac{1}{1}$ **68-0313**
- Fig. 0 $\frac{1}{1}$ **68-0314**
- Fig. 1 $\frac{1}{1}$ **68-0315**

LEMPERT
68-0310
 - **68-0315**
 20,5 cm, 8"

$\frac{1}{2}$



biegsam
 malleable
 maleable
 malleables
 malleabile

- Fig. 1 $\frac{1}{1}$ **71-0560**
- Fig. 2 $\frac{1}{1}$ **71-0561**
- Fig. 3 $\frac{1}{1}$ **71-0562**

HALLE
71-0560
 - **71-0562**
 21 cm, 8 $\frac{1}{4}$ "

$\frac{1}{2}$



DAUBENSPECK
71-0580
 19,5 cm, 7 $\frac{3}{4}$ "

$\frac{1}{2}$



- Fig. 000 $\frac{1}{1}$ **47-1540**
- Fig. 00 $\frac{1}{1}$ **47-1541**
- Fig. 0 $\frac{1}{1}$ **47-1542**
- Fig. 1 $\frac{1}{1}$ **47-1543**

47-1540
 - **47-1543**
 25 cm, 10"

$\frac{1}{2}$



- Fig. 000 $\frac{1}{1}$ **47-1550**
- Fig. 00 $\frac{1}{1}$ **47-1551**
- Fig. 0 $\frac{1}{1}$ **47-1552**
- Fig. 1 $\frac{1}{1}$ **47-1553**

47-1550
 - **47-1553**
 25 cm, 10"

$\frac{1}{2}$



- Fig. 000 $\frac{1}{1}$ **47-1560**
- Fig. 00 $\frac{1}{1}$ **47-1561**
- Fig. 0 $\frac{1}{1}$ **47-1562**
- Fig. 1 $\frac{1}{1}$ **47-1563**

47-1560
 - **47-1563**
 25 cm, 10"

$\frac{1}{2}$

Scharfe Löffel

Bone Currettes

Cucharillas cortantes

Currettes

Curette per ossa





 ^{1/1} **47-1570**
2 mm

 ^{1/1} **47-1571**
3 mm

 ^{1/1} **47-1572**
4 mm

 ^{1/1} **47-1573**
5 mm

 ^{1/1} **47-1574**
6 mm

 ^{1/1} **47-1575**
7 mm

 ^{1/1} **47-1576**
8 mm

 ^{1/1} **47-1577**
10 mm

 ^{1/1} **47-1578**
12 mm

 ^{1/1} **47-1579**
14 mm



^{1/2}

47-1570
- 47-1579

18 - 22 cm, 7" - 8^{3/4}"

schwedische Modelle
Swedish patterns
modelos sueco
modèles suédois
modelli svedese

 ^{1/1} **47-1580**
ø 2 mm

 ^{1/1} **47-1581**
ø 3 mm

 ^{1/1} **47-1582**
ø 4 mm

 ^{1/1} **47-1583**
ø 5 mm

 ^{1/1} **47-1584**
ø 6 mm

 ^{1/1} **47-1585**
ø 7 mm

 ^{1/1} **47-1586**
ø 8 mm

 ^{1/1} **47-1587**
ø 10 mm

 ^{1/1} **47-1588**
ø 12 mm

 ^{1/1} **47-1589**
ø 14 mm



^{1/2}

47-1580
- 47-1589

17 - 20 cm, 6^{3/4}" - 8"

schwedische Modelle
Swedish patterns
modelos sueco
modèles suédois
modelli svedese

 ^{1/1} **95-0844**
Fig. 1

 ^{1/1} **95-0845**
Fig. 2

 ^{1/1} **95-0846**
Fig. 3

 ^{1/1} **95-0847**
Fig. 4

 ^{1/1} **95-0848**
Fig. 5

 ^{1/1} **95-0849**
Fig. 6



^{1/2}

SIMON
95-0844
- 95-0849
24 cm, 9^{1/2}"



Scharfe Löffel
 Bone Currettes
 Cucharillas cortantes
 Curettes
 Curette per ossa

Stößel
 Tampers
 Pisón
 Chasse-Greffons
 Punzoni

 1/1
 Fig. 0000

47-1600

 1/1
 Fig. 000

47-1601

 1/1
 Fig. 00

47-1602

 1/1
 Fig. 0

47-1603

 1/1
 Fig. 1

47-1604

 1/1
 Fig. 2

▶ **47-1605**

 1/1
 Fig. 3

47-1606

 1/1
 Fig. 4

47-1607

 1/1
 Fig. 5

47-1608

 1/1
 Fig. 6

47-1609



1/2

VOLKMANN
47-1600
 - **47-1609**
 17,5 cm, 7"

Scharfe Löffel mit Ferrozellgriff
 Bone curettes with handle from artificial wood
 Cucharillas cortantes con mango de madera artificial
 Curettes avec manche en „Ferozell“
 Curette taglienti con manico in legno artificiale

 1/1
 Fig. 0000

47-1610

 1/1
 Fig. 000

47-1611

 1/1
 Fig. 00

47-1612

 1/1
 Fig. 0

47-1613

 1/1
 Fig. 1

47-1614

 1/1
 Fig. 2

▶ **47-1615**

 1/1
 Fig. 3

47-1616

 1/1
 Fig. 4

47-1617

 1/1
 Fig. 5

47-1618

 1/1
 Fig. 6

47-1619



1/2

VOLKMANN
47-1610
 - **47-1619**
 28 cm, 11"

Scharfe Löffel mit Ferrozellgriff
 Bone curettes with handle from artificial wood
 Cucharillas cortantes con mango de madera artificial
 Curettes avec manche en „Ferozell“
 Curette taglienti con manico in legno artificiale

Sterilisierbar im Autoklav bei 3 bar Überdruck (143°C) !
 Can be autoclaved at 3 bar overpressure (143°C) !
 Esterilizables en autoclave a 3 bar sobrepresión (143°C) !
 Stérilisables à l'autoclave à 3 bars (143°) !
 Può'essere autoclavato a 3 bar di pressione (143°) !

 1/1

46-0078

ø 2 mm

 1/1

46-0079

ø 3 mm

 1/1

46-0080

ø 4 mm

 1/1

▶ **46-0081**

ø 5 mm

 1/1

46-0082

ø 6 mm

 1/1

46-0083

ø 8 mm

 1/1

46-0084

ø 10 mm



1/2

46-0078
 - **46-0084**
 16 cm, 6 1/4"

Stößel
 Tampers
 Pisón
 Chasse-Greffons
 Punzoni

 1/1

46-0094

ø 3 mm

 1/1

▶ **46-0095**

ø 5 mm

 1/1

46-0096

ø 8 mm

 1/1

46-0097

ø 12 mm

 1/1

46-0098

ø 14 mm

 1/1

46-0099

ø 16 mm



1/2

46-0094
 - **46-0099**
 20 cm, 8"

Stößel mit Ferrozellgriff
 Tampers with handle from artificial wood
 Pisón con mango de madera artificial
 Chasse-Greffons avec manche en „Ferozell“
 Punzone con manico in legno artificiale

Osteotome

Osteotomes
Osteótomos
Ostéotomes
Osteotomi

Flachmeißel

Chisels
Cinceles
Ciseaux-burins
Scalpelli

Hohlmeißel

Gouges
Gubias
Gouges
Sgorbie



HOKE

46-0002 2 mm
46-0003 3 mm
▶ **46-0004** 4 mm
46-0005 5 mm
46-0006 6 mm
46-0007 7 mm
46-0008 8 mm
14 cm, 5 1/2"

Osteotome
Osteotomes
Osteótomos
Ostéotomes
Osteotomi



HOKE

46-0012 2 mm
46-0013 3 mm
▶ **46-0014** 4 mm
46-0015 5 mm
46-0016 6 mm
46-0017 7 mm
46-0018 8 mm
14 cm, 5 1/2"

Osteotome
Osteotomes
Osteótomos
Ostéotomes
Osteotomi

4 mm



FREER

71-0655
17 cm, 6 3/4"

Flachmeißel
Chisel
Cinzel
Ciseaux-burins
Scalpelli

4 mm



FREER

71-0656
17 cm, 6 3/4"

Flachmeißel
Chisel
Cinzel
Ciseaux-burins
Scalpelli

4 mm



WEST

63-2900
16 cm, 6 1/4"

Flachmeißel
Chisel
Cinzel
Ciseaux-burins
Scalpelli

4 mm



WEST

63-2905
16 cm, 6 1/4"

Hohlmeißel
Gouge
Gubia
Gouges
Sgorbie

6 mm



WEST

63-2901
19 cm, 7 1/2"

Flachmeißel
Chisel
Cinzel
Ciseaux-burins
Scalpelli

6 mm



WEST

63-2906
19 cm, 7 1/2"

Hohlmeißel
Gouge
Gubia
Gouges
Sgorbie



Osteotome

Osteotomes
Osteótomos
Ostéotomes
Osteotomi



COTTLE

- 77-0630** 4 mm
- ▶ **77-0631** 6 mm
- 77-0632** 8 mm
- 77-0633** 10 mm
- 77-0634** 12 mm
- 18 cm, 7"

mit Graduierung
with depth markings
graduado
gradué
graduato



COTTLE

- 77-0620**
- 18 cm, 7"

mit Graduierung
with depth markings
graduado
gradué
graduato

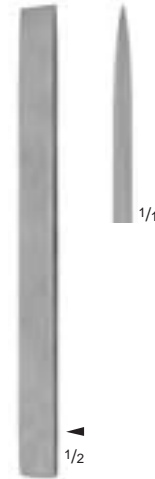

MINI-LAMBOTTE

- 46-0149** 2 mm
- 46-0150** 3 mm
- 46-0151** 4 mm
- 46-0152** 6 mm
- 46-0153** 8 mm
- ▶ **46-0154** 10 mm
- 46-0155** 12 mm
- 46-0157** 15 mm
- 12,5 cm, 5"



MINI-LAMBOTTE

- 46-0350** 2 mm
- 46-0351** 3 mm
- 46-0352** 4 mm
- ▶ **46-0353** 6 mm
- 46-0354** 8 mm
- 46-0355** 10 mm
- 46-0356** 12 mm
- 46-0357** 15 mm
- 17 cm, 6³/₄"

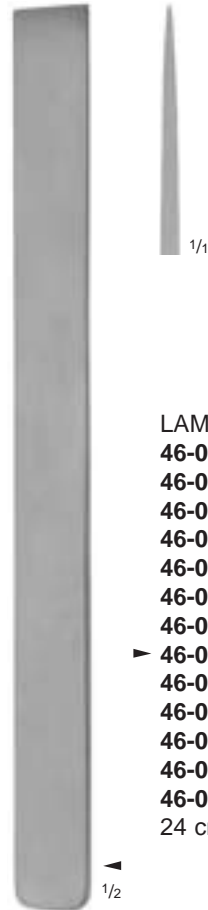

LAMBOTTE

- 46-0360** 4 mm
- 46-0170** 6 mm
- 46-0361** 8 mm
- 46-0362** 10 mm
- 46-0172** 13 mm
- 46-0363** 15 mm
- 46-0364** 18 mm
- ▶ **46-0174** 20 mm
- 46-0176** 25 mm
- 46-0177** 30 mm
- 46-0178** 38 mm
- 46-0365** 44 mm
- 46-0366** 50 mm
- 24 cm, 9¹/₂"

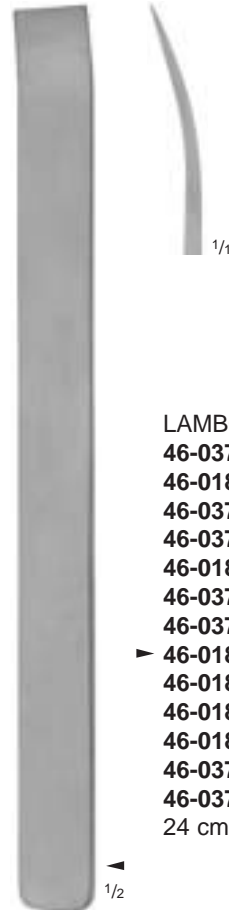

LAMBOTTE

- 46-0370** 4 mm
- 46-0180** 6 mm
- 46-0371** 8 mm
- 46-0372** 10 mm
- 46-0182** 13 mm
- 46-0373** 15 mm
- 46-0374** 18 mm
- ▶ **46-0184** 20 mm
- 46-0186** 25 mm
- 46-0187** 30 mm
- 46-0188** 38 mm
- 46-0375** 44 mm
- 46-0376** 50 mm
- 24 cm, 9¹/₂"

Osteotome

Osteotomes
Osteótomos
Ostéotomes
Osteotomi

Flachmeißel

Chisels
Cinceles
Ciseaux-burins
Scalpelli

Hohlmeißel

Gouges
Gubias
Gouges
Sgorbie



1/1

- 46-0020** 4 mm
46-0022 6 mm
46-0024 8 mm
▶ **46-0026** 10 mm
46-0028 12 mm
13,5 cm, 5 1/4"

1/2

Osteotome
Osteotomes
Osteótomos
Ostéotomes
Osteotomi



1/1

- 46-0030** 4 mm
46-0032 6 mm
46-0034 8 mm
▶ **46-0036** 10 mm
46-0038 12 mm
13,5 cm, 5 1/4"

1/2

Flachmeißel
Chisels
Cinceles
Ciseaux-burins
Scalpelli



1/1

- 46-0040** 4 mm
46-0042 6 mm
46-0044 8 mm
▶ **46-0046** 10 mm
46-0048 12 mm
13,5 cm, 5 1/4"

1/2

Hohlmeißel
Gouges
Gubias
Gouges
Sgorbie



1/1

- ALEXANDER**
67-0391 4 mm
67-0392 6 mm
67-0393 8 mm
▶ **67-0394** 10 mm
67-0395 12 mm
17,5 cm, 7"

1/2

Osteotome
Osteotomes
Osteótomos
Ostéotomes
Osteotomi



1/1

- ALEXANDER**
67-0371 4 mm
67-0372 6 mm
67-0373 8 mm
▶ **67-0374** 10 mm
67-0375 12 mm
17,5 cm, 7"

1/2

Flachmeißel
Chisels
Cinceles
Ciseaux-burins
Scalpelli



1/1

- ALEXANDER**
67-0381 4 mm
67-0382 6 mm
67-0383 8 mm
▶ **67-0384** 10 mm
67-0385 12 mm
17,5 cm, 7"

1/2

Hohlmeißel
Gouges
Gubias
Gouges
Sgorbie



Osteotome
 Osteotomes
 Osteótomos
 Ostéotomes
 Osteotomi

Flachmeißel
 Chisels
 Cinceles
 Ciseaux-burins
 Scalpelli

Hohlmeißel
 Gouges
 Gubias
 Gouges
 Sgorbie



STILLE

- 46-0380** 10 mm
- 46-0381** 12 mm
- ▶ **46-0382** 15 mm
- 46-0383** 20 mm
- 46-0384** 25 mm
- 20,5 cm, 8"

Osteotome
 Osteotomes
 Osteótomos
 Ostéotomes
 Osteotomi



STILLE

- 46-0248** 8 mm
- 46-0250** 10 mm
- 46-0252** 12 mm
- 46-0255** 15 mm
- ▶ **46-0260** 20 mm
- 46-0265** 25 mm
- 46-0270** 30 mm
- 20,5 cm, 8"

Osteotome
 Osteotomes
 Osteótomos
 Ostéotomes
 Osteotomi



STILLE

- 46-0200** 10 mm
- 46-0202** 12 mm
- 46-0205** 15 mm
- ▶ **46-0210** 20 mm
- 46-0215** 25 mm
- 20,5 cm, 8"

Flachmeißel
 Chisels
 Cinceles
 Ciseaux-burins
 Scalpelli



STILLE

- 46-0225** 10 mm
- 46-0227** 12 mm
- 46-0230** 15 mm
- ▶ **46-0235** 20 mm
- 46-0240** 25 mm
- 20,5 cm, 8"

Hohlmeißel
 Gouges
 Gubias
 Gouges
 Sgorbie

Osteotome, Flachmeißel und Hohlmeißel mit Ferrozellgriff

Osteotomes, Chisels and Gouges with handle from artificial wood
 Osteótomos, cinceles y gubias con mango de madera artificial
 Ostéotomes, ciseaux-burins et gouges avec manche en „Ferozell“
 Osteotomi, scalpelli e sgorbie con manico in legno artificiale



Sterilisierbar im Autoklav bei 3 bar Überdruck (143°C) !
 Can be autoclaved at 3 bar overpressure (143°C) !
 Esterilizables en autoclave a 3 bar sobrepresión (143°C) !
 Stérilisables à l'autoclave à 3 bars (143°) !
 Può essere autoclavato a 3 bar di pressione (143°) !



46-0900
 18,5 cm, 7 1/4"

Meißelgriff für auswechselbare Klingen mit Spannschlüssel (46-0901)

Handle for interchangeable blades, with key (46-0901)

Mango para hojas intercambiables, con llave (46-0901)

Manche pour lames interchangeables avec clef (46-0901)

Manico per lame intercambiabili, con chiave (46-0901)



46-0902 5 mm

46-0903 10 mm

46-0904 16 mm

► **46-0905** 25 mm

Auswechselbare Osteotomklingen

Interchangeable osteotome blades

Osteótomos, hojas intercambiables

Lames-ostéotomes interchangeables

Lame intercambiabili per osteotomo



46-0906 5 mm

46-0907 10 mm

46-0908 16 mm

► **46-0909** 25 mm

Auswechselbare Flachmeißelklingen

Interchangeable chisel blades

Cinceles, hojas intercambiables

Lames-ciseaux-burins interchangeables

Lame a scalpello intercambiabili

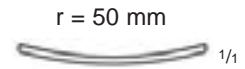

46-0910

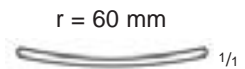

46-0911



46-0912



46-0910 25 mm (r = 50 mm)

46-0911 25 mm (r = 60 mm)

► **46-0912** 25 mm (r = 70 mm)

Auswechselbare Hohlmeißelklingen

Interchangeable gouges blades

Gubias, hojas intercambiables

Lames-gouges interchangeables

Lame a sgorbia intercambiabili



Osteotome und Hohlmeißel mit Ferrozellgriff

Osteotomes and Gouges with handle from artificial wood

Osteótomos y gubias con mango de madera artificial

Ostéotomes et gouges avec manche en „Ferozell“

Osteotomi e sgorbie con manico in legno artificiale

Sterilisierbar im Autoklav bei 3 bar Überdruck (143°C) !

Can be autoclaved at 3 bar overpressure (143°C) !

Esterilizables en autoclave a 3 bar sobrepresión (143°C) !

Stérilisables à l'autoclave à 3 bars (143°) !

Puo'essere autoclavato a 3 bar di pressione (143°) !



MINI-LEXER

- 46-0050** 4 mm
- 46-0051** 6 mm
- ▶ **46-0052** 8 mm
- 46-0053** 10 mm
- 46-0054** 12 mm
- 18 cm, 7"

Osteotome
Osteotomes
Osteótomos
Ostéotomes
Osteotomi



MINI-LEXER

- 46-0060** 4 mm
- 46-0061** 6 mm
- ▶ **46-0062** 8 mm
- 46-0063** 10 mm
- 46-0064** 12 mm
- 18 cm, 7"

Hohlmeißel
Gouges
Gubias
Gouges
Sgorbie



LEXER

- 46-0801** 5 mm
- 46-0802** 7 mm
- 46-0803** 10 mm
- 46-0805** 15 mm
- ▶ **46-0806** 20 mm
- 46-0807** 25 mm
- 46-0808** 30 mm
- 22 cm, 8^{3/4}"

Osteotome
Osteotomes
Osteótomos
Ostéotomes
Osteotomi



LEXER

- 46-0811** 5 mm
- 46-0812** 7 mm
- 46-0813** 10 mm
- 46-0815** 15 mm
- ▶ **46-0816** 20 mm
- 46-0817** 25 mm
- 46-0818** 30 mm
- 22 cm, 8^{3/4}"

Hohlmeißel
Gouges
Gubias
Gouges
Sgorbie

Osteotome, Hohlmeißel und Flachmeißel mit Ferrozellgriff

Osteotomes, Gouges and Chisels with handle from artificial wood
 Osteótomos, gubias y cinceles con mango de madera artificial
 Ostéotomes, gouges et ciseaux-burins avec manche en „Ferozell“
 Osteotomi, sgorbie e scalpelli con manico in legno artificiale



LEXER
 ▶ 46-0920 10 mm
 ▶ 46-0921 15 mm
 27,5 cm, 10³/₄“

Osteotome, abgewinkelt
 Osteotomes, angled
 Osteótomos, acodados
 Ostéotomes, angulés
 Osteotomi, angolati



LEXER
 ▶ 46-0925 10 mm
 ▶ 46-0926 15 mm
 27,5 cm, 10³/₄“

Hohlmeißel, abgewinkelt
 Gouges, angled
 Gubias, acodadas
 Gouges, angulées
 Sgorbie, angolati



▶ 46-0930 10 mm
 ▶ 46-0931 15 mm
 16 cm, 6¹/₄“

Flachmeißel
 Chisels
 Cinceles
 Ciseaux-burins
 Scalpelli



▶ 46-0940 10 mm
 ▶ 46-0941 15 mm
 ▶ 46-0942 20 mm
 20 cm, 8“

Flachmeißel
 Chisels
 Cinceles
 Ciseaux-burins
 Scalpelli



▶ 46-0945 10 mm
 ▶ 46-0946 15 mm
 ▶ 46-0947 20 mm
 20 cm, 8“

Flachmeißel
 Chisels
 Cinceles
 Ciseaux-burins
 Scalpelli



Flachmeißel und Hohlmeißel mit Ferrozellgriff

Chisels and Gouges with handle from artificial wood

Cinceles y gubias con mango de madera artificial

Ciseaux-burins et gouges avec manche en „Ferozell“

ScalPELLi e sgorbie con manico in legno artificiale

Sterilisierbar im Autoklav bei 3 bar Überdruck (143°C) !

Can be autoclaved at 3 bar overpressure (143°C) !

Esterilizables en autoclave a 3 bar sobrepresión (143°C) !

Stérilisables à l'autoclave à 3 bars (143°) !

Puo'essere autoclavato a 3 bar di pressione (143°) !

20 mm



46-0950

24,5 cm, 9^{3/4}“

Flachmeißel
Chisel
Cinzel
Ciseaux-burins
Scalpello

16 mm



46-0952

26,5 cm, 10^{1/2}“

Flachmeißel
Chisel
Cinzel
Ciseaux-burins
Scalpello

9 mm



46-0954

22 cm, 8^{3/4}“

**Hohlmeißel zum Freilegen
abgebrochener Schrauben**

Gouge for removing
broken screws

Gubia para exteriorizar
tornillos truncados

Gouge pour extraire
les vis cassées

Sgorbie per rimuovere
viti rotte



ZIELKE

46-0956 5,5 mm

▶ **46-0958** 9,0 mm

23 cm, 9“

**Hohlmeißel für Skoliose-
Operationen**

Gouges for scoliosis
operations

Gubias para operaciones
scoliosis

Gouge pour scoliose

Sgorbie per interventi
di scoliosi

Hohlmeißel mit Ferrozellgriff

Gouges with handle from artificial wood

Gubias con mango de madera artificial

Gouges avec manche en „Ferozell“

Sgorbie con manico in legno artificiale



Sterilisierbar im Autoklav bei 3 bar Überdruck (143°C) !

Can be autoclaved at 3 bar overpressure (143°C) !

Esterilizables en autoclave a 3 bar sobrepresión (143°C) !

Stérilisables à l'autoclave à 3 bars (143°) !

Puo'essere autoclavato a 3 bar di pressione (143°) !



- 46-0960 5 mm
 - ▶ 46-0961 10 mm
 - 46-0962 15 mm
- 25 cm, 10"

Spongiosa-Hohlmeißel
Spongiosa gouges
Gubias de esponjosa
Ciseaux-burins spongiose
Sgorbie per tessuto osseo spugnoso



- 46-0965 5 mm
 - ▶ 46-0966 10 mm
 - 46-0967 15 mm
- 25 cm, 10"

Spongiosa-Hohlmeißel
Spongiosa gouges
Gubias de esponjosa
Ciseaux-burins spongiose
Sgorbie per tessuto osseo spugnoso



- LEXER
 - 46-0822 7 mm
 - ▶ 46-0823 10 mm
- 28,5 cm, 11 1/4"

Spongiosa-Hohlmeißel
Spongiosa gouges
Gubias de esponjosa
Ciseaux-burins spongiose
Sgorbie per tessuto osseo spugnoso



Hohlmeißel mit Ferrozellgriff

Gouges with handle from artificial wood

Gubias con mango de madera artificial

Gouges avec manche en „Ferozell“

Sgorbie con manico in legno artificiale

Sterilisierbar im Autoklav bei 3 bar Überdruck (143°C) !

Can be autoclaved at 3 bar overpressure (143°C) !

Esterilizables en autoclave a 3 bar sobrepresión (143°C) !

Stérilisables à l'autoclave à 3 bars (143°) !

Puo'essere autoclavato a 3 bar di pressione (143°) !

8 mm



COBB

46-0970

27,5 cm, 10^{3/4}“

**Spinal-Hohlmeißel,
gerade**

Spinal gouge,
straight

Gubia espinal,
recta

Gouge spinale,
droite

Sgorbie spinali,
rette

8 mm



COBB

46-0971

27 cm, 10^{3/4}“

**Spinal-Hohlmeißel,
leicht gebogen**

Spinal gouge,
light curved

Gubia espinal,
ligeramente curva

Gouge spinale,
légèrement courbe

Sgorbie spinali,
legermente curve

8 mm



COBB

46-0972

27 cm, 10^{3/4}“

**Spinal-Hohlmeißel,
stark gebogen**

Spinal gouge,
strong curved

Gubia espinal,
fuertemente curva

Gouge spinale,
forte courbure

Sgorbie spinali,
molto curve

8 mm



COBB

46-0973

27 cm, 10^{3/4}“

**Spinal-Hohlmeißel,
nach hinten gebogen**

Spinal gouge,
curved backwards

Gubia espinal,
fuertemente curva

Gouge spinale,
contre coudée

Sgorbie spinali,
angolate

Hämmer

Mallets
Martillos
Maillets
Martelli



ø 20 mm
140 g

47-0101
16,5 cm, 6 1/2"
mit Bleifüllung
lead filled head
cabezal relleno
de plomo
tête en plomb
testa di piombo

1/2



ø 20 mm
100 g

47-0102
16,5 cm, 6 1/2"

1/2



ø 26 mm
260 g

LUCAE
47-0110
19,5 cm, 7 3/4"

1/2



ø 26 mm
300 g

WILLIGER
47-0136
24 cm, 9 1/2"

1/2



ø 22 mm
165 g

47-0103
19 cm, 7 1/2"
mit Bleifüllung
lead filled head
cabezal relleno
de plomo
tête en plomb
testa di piombo

1/2



ø 27 mm
140 g

HAJEK
47-0109
20 cm, 8"

1/2



ø 20 mm
110 g

HAJEK
47-0108
21,5 cm, 8 1/2"

1/2



ø 30 mm
220 g

COLLIN
47-0132
20 cm, 8"

1/2



Hämmer

Mallets
Martillos
Maillets
Martelli

47-0133
ø 25 mm
120 g

▶ **47-0134**
ø 30 mm
180 g

47-0135
ø 35 mm
260 g



DOYEN
47-0133
- **47-0135**
19,5 cm, 7 3/4"

ø 25 mm
210 g



GERZOG
47-0100
19 cm, 7 1/2"
mit Bleifüllung
lead filled head
cabezal relleno
de plomo
tête en plomb
testa di piombo

ø 40 mm
700 g



KIRK
47-0105
21 cm, 8 1/4"

ø 20 mm
185 g



MEAD
47-0115
19 cm, 7 1/2"
mit auswechselbaren
Kunststoffbacken (47-0195)
with interchangeable plastic
disks (47-0195)
con tapas de plástico inter-
cambiables (47-0195)
avec masse plastique inter-
changeable (47-0195)
con piastre di plastica inter-
cambiabili (47-0195)

ø 25 mm
140 g



47-0117
18,5 cm, 7 1/4"
mit auswechselbaren
Kunststoffbacken (47-0197)
with interchangeable plastic
disks (47-0197)
con tapas de plástico inter-
cambiables (47-0197)
avec masse plastique inter-
changeable (47-0197)
con piastre di plastica inter-
cambiabili (47-0197)

Hämmer mit Ferrozellgriff

Mallets with handle from artificial wood
Martillos con mango de madera artificial
Maillets avec manche en „Ferozell“
Martelli con manico in legno artificiale



ø 30 mm
215 g



47-0111
25 cm, 10"

mit auswechselbaren
Kunststoffbacken (47-0191)

with interchangeable plastic
disks (47-0191)

con tapas de plástico inter-
cambiables (47-0191)

avec masse plastique inter-
changeable (47-0191)

con piastre di plastica inter-
cambiabili (47-0191)

47-0118
ø 32 mm
390 g

▶ **47-0119**
ø 35 mm
540 g

47-0120
ø 40 mm
740 g



47-0118
- **47-0120**
24 cm, 9 1/2"

ø 45 mm
250 g



47-0140
26 cm, 10 1/4"

aus Ferrozell, mit
Bleifüllung

from artificial wood,
lead filled head

de madera artificial, cabe-
zal relleno de plomo

manche bois, Ferrozell,
tête en plomb

in legno artificiale,
testa di piombo

47-0142
ø 35 mm
120 g

▶ **47-0143**
ø 42 mm
170 g

47-0141
ø 50 mm
220 g



47-0141
- **47-0143**
26 cm, 10 1/4"

aus Ferrozell
from artificial wood
de madera artificial
entièrement en Ferrozell
in legno artificiale



Hämmer

Mallets
Martillos
Maillets
Martelli

ø 30 mm
240 g



COTTLE
47-0116
19 cm, 7 1/2"

1 Seite flach
1 Seite convex

1 side flat
1 side convex
1 lado plano
1 lado convexo
1 côte plat
1 côte convexe
1 lato piatto
1 lato convesso

ø 40 mm
700 g



HEATH
47-0121
18,5 cm, 7 1/4"

mit Kupferfüllung
copper filled head
cabezal relleno
de cobre
tête en cuivre
testa di rame

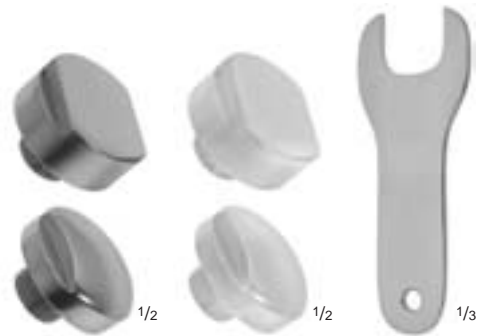

47-0147

47-0148

47-0149

ø 35 mm
170/260 g



WAGNER
47-0146
24,5 cm, 9 3/4"

mit 1 Paar Metallbacken (47-0147), 1 Paar Kunststoffbacken (47-0148) und 1 Schlüssel (47-0149)

with 1 pair of metal disks (47-0147), 1 pair of plastic disks (47-0148) and 1 wrench (47-0149)

con 1 par de tapas de metal (47-0147), 1 par de tapas de plástico (47-0148) y 1 llave (47-0149)

avec 1 paire de disques métalliques (47-0147), 1 paire de disques plastiques (47-0148) et 1 clef plate (47-0149)

con 1 paio de piastre di metallo (47-0147), 1 paio de piastre di plastica (47-0148) e 1 chiave (47-0149)

Hämmer

Mallets
Martillos
Maillets
Martelli



ø 30 mm
300 g



1/2

BERGMANN
47-0129
23,5 cm, 9 1/4"

ø 45 mm
300 g



1/2

BERGMANN
47-0126
25 cm, 10"

ø 29/42 mm
400 g



1/2

47-0150
25 cm, 10"

ø 40 mm
550 g



1/2

OMBREDANNE
47-0127
25 cm, 10"



Repositionszangen
Reposition Forceps
Pinzas para reducción
Pincas à réduction
Pinze per riposizioni



45-0123

13,5 cm, 5 1/4"

für Kieferrepositionen
for maxillary reposition
para la reducción maxilar
pour reposition du maxillaire
per riposizione mascellare



45-0127

13 cm, 5 1/8"

für Kleinfragmente
for small fragments
para fragmentos pequeños
pour petits fragments
per piccoli frammenti



45-0131

20,5 cm, 8"



45-0133

13,5 cm, 5 1/4"



45-0135

14 cm, 5 1/2"



LEWIN

45-0130

17,5 cm, 7"

Repositionszangen

Reposition Forceps
Pinzas para reducción
Pincès à réduction
Pinze per riposizioni

Sequesterzangen

Sequestrum Forceps
Pinzas para secuestro
Pincès à séquestre
Pinze per frammento osseo



45-0136

17 cm, 6³/₄"

Repositionszange
Reposition forceps
Pinza para reducción
Pincès à réduction
Pinza per riposizioni

1/2



45-0138

24 cm, 9¹/₂"

Repositionszange
Reposition forceps
Pinza para reducción
Pincès à réduction
Pinza per riposizioni

1/2



45-0140

18,5 cm, 7¹/₄"

Patellazange
Patella forceps
Pinza patella
Pincès patella
Pinza per rotula

1/2



45-0348

20 cm, 8"

Sequesterzange
Sequestrum forceps
Pinza para secuestro
Pincès à séquestre
Pinze per frammento osseo

1/2



45-0349

20 cm, 8"

Sequesterzange
Sequestrum forceps
Pinza para secuestro
Pincès à séquestre
Pinze per frammento osseo

1/2



VAN BUREN

45-0350

23 cm, 9"

Sequesterzange
Sequestrum forceps
Pinza para secuestro
Pincès à séquestre
Pinze per frammento osseo

1/2



Knochenhaltezangen

Bone Holding Forceps

Pinzas para huesos

Daviers

Tenaglie per ossa



DINGMANN
48-0435
18,5 cm, 7 1/4"



DINGMANN modif.
48-0436
18,5 cm, 7 1/4"



45-0099
20 cm, 8"



LANGENBECK
45-0100
19,5 cm, 7 3/4"



FERGUSSON
45-0110
20,5 cm, 8"

Knochenhaltezangen

Bone Holding Forceps

Pinzas para huesos

Daviers

Tenaglie per ossa



KERN-MINI
45-0159
17 cm, 6³/₄"

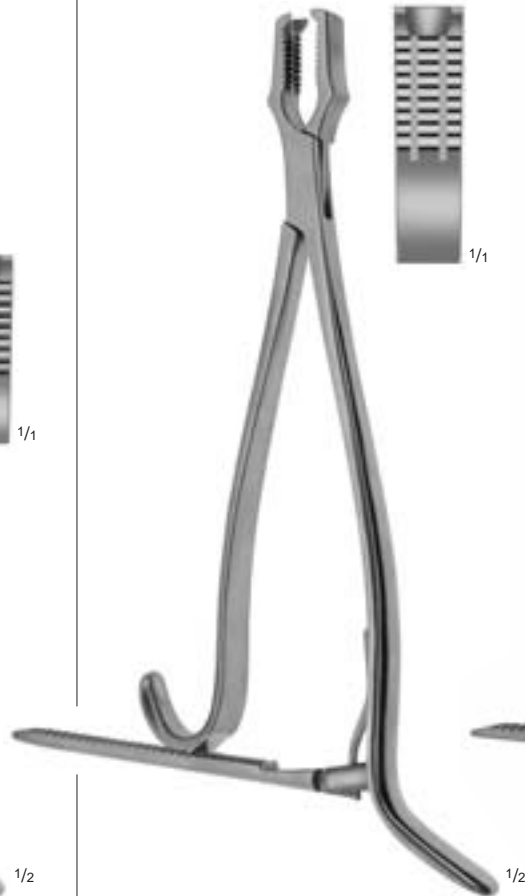

KERN-LANE
45-0161
23,5 cm, 9¹/₄"

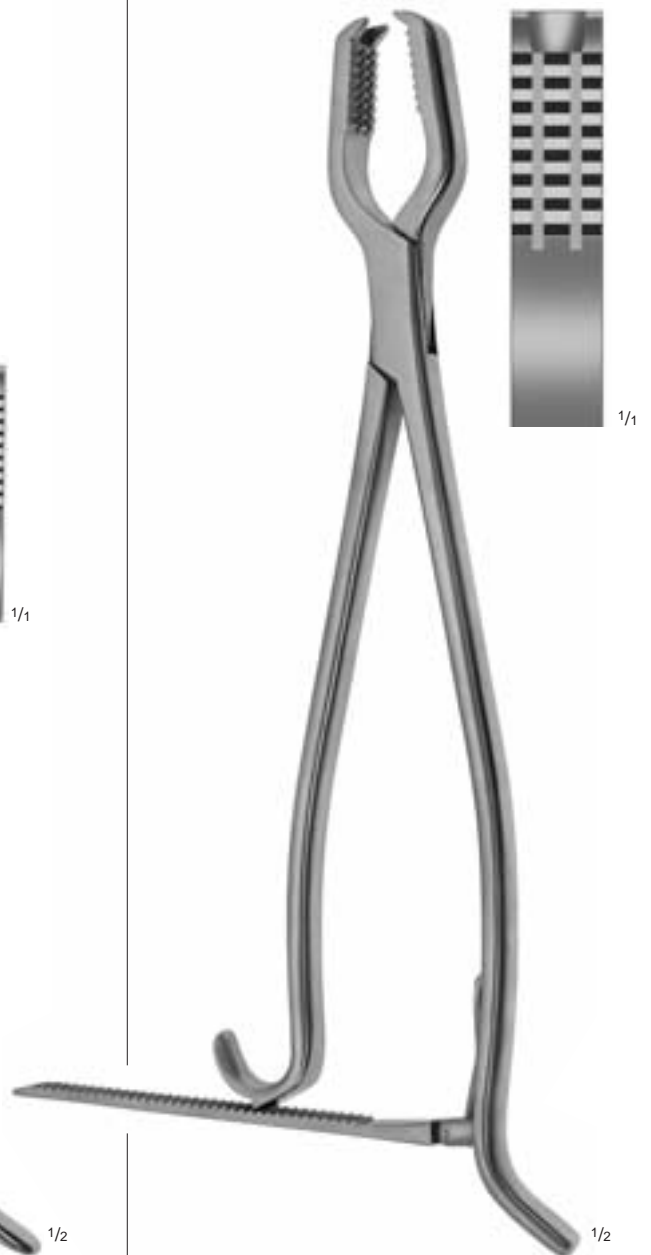

LANE
45-0150
33 cm, 13"



Knochenhaltezangen

Bone Holding Forceps

Pinzas para huesos

Daviers

Tenaglie per ossa



1/1



1/2

FARABEUF-LAMBOTTE

45-0175

25,5 cm, 10"

verstellbar
adjustable
ajustable
à crémaillère
regolabili



1/2

LAMBOTTE

45-0185

- **45-0187**

verstellbar, 1 Maulteil beweglich
adjustable, 1 jaw swiveled
ajustable, 1 mandibula movable
à crémaillère, 1 mors mobile
regolabili, 1 mandibola mobile



9 mm

1/1

► **45-0185**

22 cm, 8³/₄"



10 mm

1/1

45-0186

27 cm, 10³/₄"



11 mm

1/1

45-0187

30,5 cm, 12"

Knochenhaltezangen

Bone Holding Forceps

Pinzas para huesos

Daviers

Tenaglie per ossa



14 mm

1/1



1/2

LAMBOTTE

45-0188

21 cm, 8 1/4"

verstellbar, 1 Maulteil beweglich
adjustable, 1 jaw swiveled
ajustable, 1 mandibula movable
à crémaillère, 1 mors mobile
regolabili, 1 mandibola mobile



1/2

ULRICH

45-0112

- **45-0118**



5,0 mm

1/1

45-0112

18 cm, 7"



7,5 mm

1/1

45-0114

23 cm, 9"



8,0 mm

1/1

45-0116

25 cm, 10"



8,5 mm

1/1

▶ **45-0118**

28 cm, 11"



Knochenhaltezangen

Bone Holding Forceps

Pinzas para huesos

Daviers

Tenaglie per ossa

9 mm



45-0191
25 cm, 10"

6 mm



45-0190
17,5 cm, 7"



1/1

12,5 mm



45-0193
27 cm, 10³/₄"

11,5 mm



▶ **45-0192**
26,5 cm, 10¹/₂"



1/2

VERBRUGGE

45-0190

- **45-0193**

mit Lappenverschluß
with lip joint
con cierre de labio
avec fermeture à lambeaux
con chiusura a tela

Knochenhaltezangen

Bone Holding Forceps

Pinzas para huesos

Daviers

Tenaglie per ossa



1/1



2,5 mm

1/1

45-0230
15 cm, 6"

6,5 mm



1/1

45-0231
19 cm, 7 1/2"

9,5 mm



1/1

45-0232
24 cm, 9 1/2"



1/2

10,0 mm



1/1

45-0233
26 cm, 10 1/4"

11,0 mm



1/1

45-0234
28 cm, 11"

45-0230
- **45-0234**

selbstzentrierend mit Gewindesperre
self-centering forceps with thread fixation
autocentrante con cremallera de tuerca
autostatique, à crémailière
pinze autocentranti con blocco di filettatura



Knochenhalteklammern

Bone Clamps
Pinzas porta-huesos
Daviers
Tenaglie per ossa

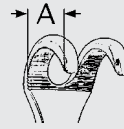

LOWMAN

- 45-0216 12 cm, 4³/₄" / 19 mm (A)
- ▶ 45-0212 18 cm, 7" / 25 mm (A)
- 45-0214 21 cm, 8¹/₄" / 29 mm (A)



LOWMAN

- 45-0201 12 cm, 4³/₄" / 19 mm (A)
- ▶ 45-0202 18 cm, 7" / 25 mm (A)
- 45-0205 21 cm, 8¹/₄" / 29 mm (A)



LOWMAN-LAMBERT

- 45-0225
21 cm, 8¹/₄" / 29 mm (A)



LOWMAN-HOGLUND

- 45-0208
18 cm, 7" / 25 mm (A)

1 Maulteil beweglich
1 jaw swiveled
1 mandibula movibile
1 mors mobile
1 mandibola mobile



GERSTER
45-0280

Distractionsklammer für Knochen-
halteklammern

Traction bar for bone clamps

Barra de tracción para pinzas
porta-huesos

Tracteur pour daviers

Barra di trazione per tenaglie
per ossa

Hohlmeißelzangen

Bone Rongeurs

Pinzas-gubias

Pinces-gouges

Pinze per ossa



LUER-FRIEDMAN
45-0628
13 cm, 5 1/8"

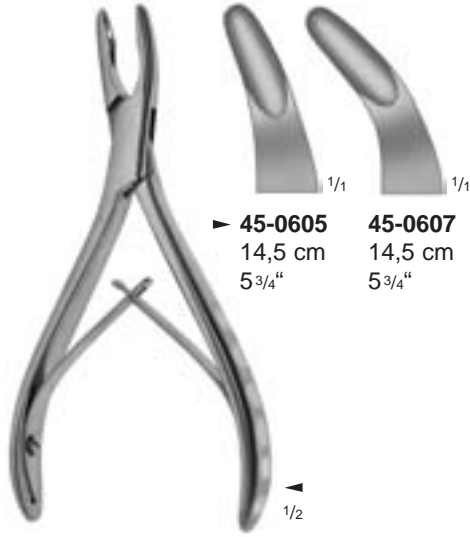

LUER
45-0605
- **45-0607**

▶ **45-0605**
14,5 cm
5 3/4"

45-0607
14,5 cm
5 3/4"

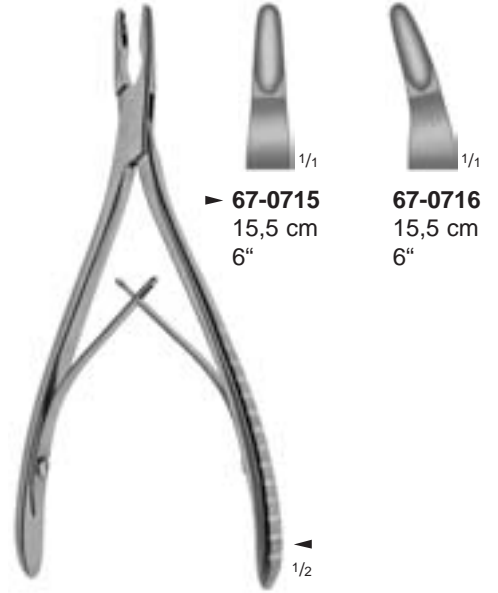

LEMPERT
67-0715
- **67-0716**

▶ **67-0715**
15,5 cm
6"

67-0716
15,5 cm
6"



BLUMENTHAL
99-0099
- **99-0101**

▶ **99-0099**
15,5 cm
6"

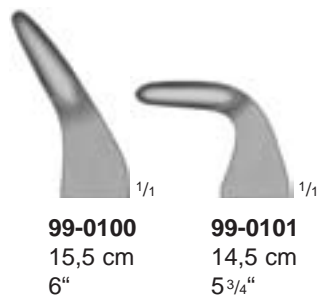

99-0100
15,5 cm
6"

99-0101
14,5 cm
5 3/4"



MEAD
67-0654
16,5 cm, 6 1/2"



MEAD
67-0656
16,5 cm, 6 1/2"



Hohlmeißelzangen

Bone Rongeurs

Pinzas-gubias

Pinces-gouges

Pinze per ossa

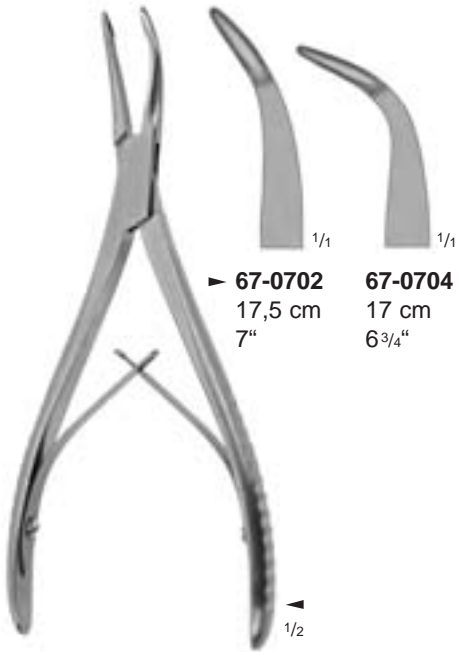

▶ **67-0702** 17,5 cm
7"
67-0704 17 cm
6³/₄"

STELLBRING
67-0702
- **67-0704**



BEYER
45-0613
17 cm, 6³/₄"

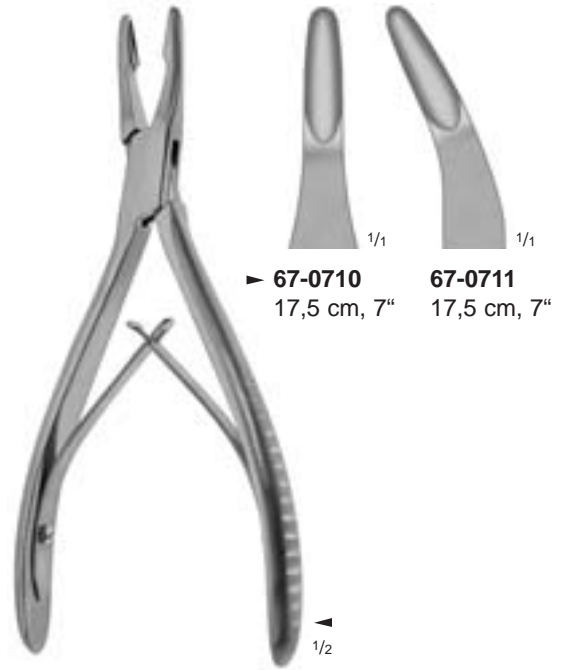

▶ **67-0710** 17,5 cm, 7"
67-0711 17,5 cm, 7"

JANSEN
67-0710
- **67-0711**

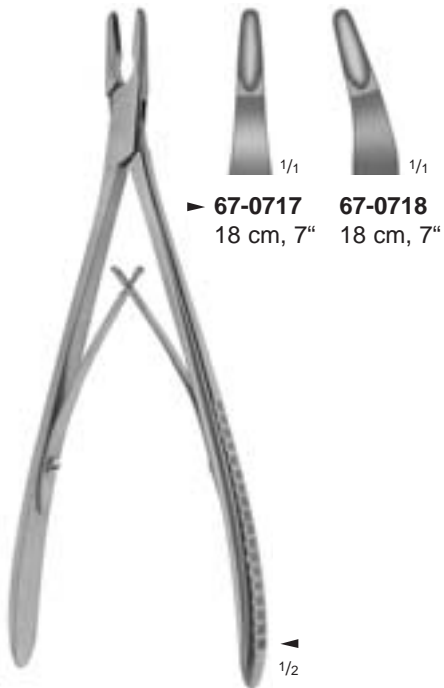

▶ **67-0717** 18 cm, 7"
67-0718 18 cm, 7"

LEMPERT
67-0717
- **67-0718**



JANSEN
67-0712
19 cm, 7¹/₂"

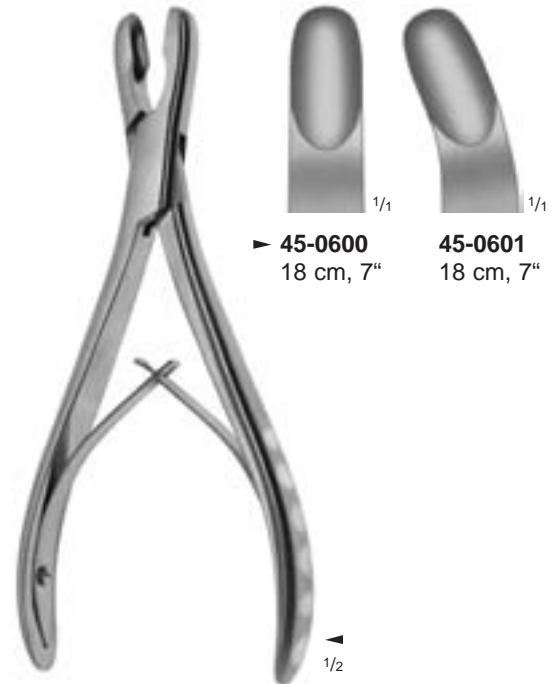

▶ **45-0600** 18 cm, 7"
45-0601 18 cm, 7"

LUER
45-0600
- **45-0601**

Hohlmeißelzangen

Bone Rongeurs
Pinzas-gubias
Pincès-gouges
Pinze per ossa



▶ **45-0460**
15 cm, 6"

45-0462
15 cm, 6"

BÖHLER
45-0460
- **45-0462**



MAYFIELD
45-0509
17,5 cm, 7"

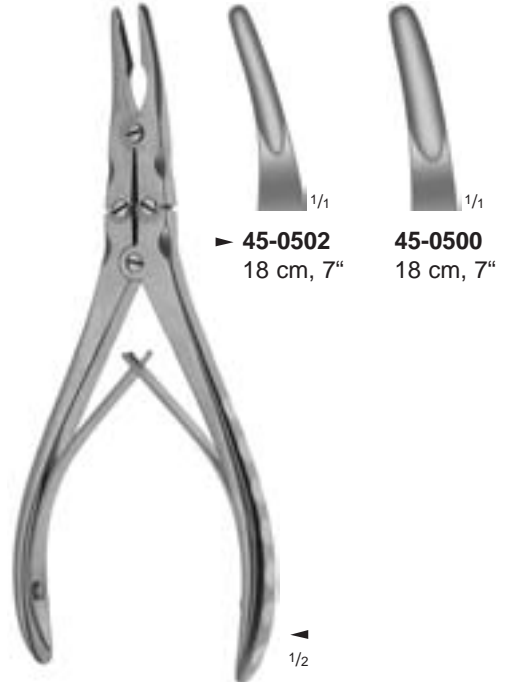

▶ **45-0502**
18 cm, 7"

45-0500
18 cm, 7"

BEYER
45-0500
- **45-0502**

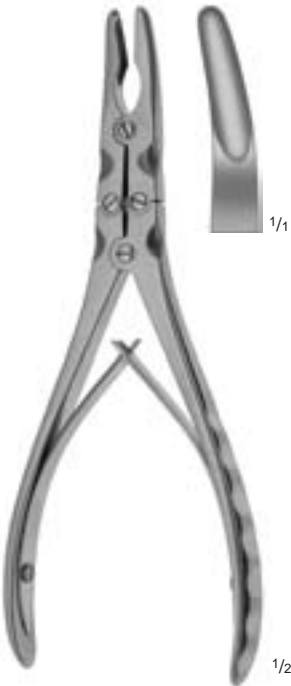

ZAUFAL-JANSEN
45-0505
18 cm, 7"

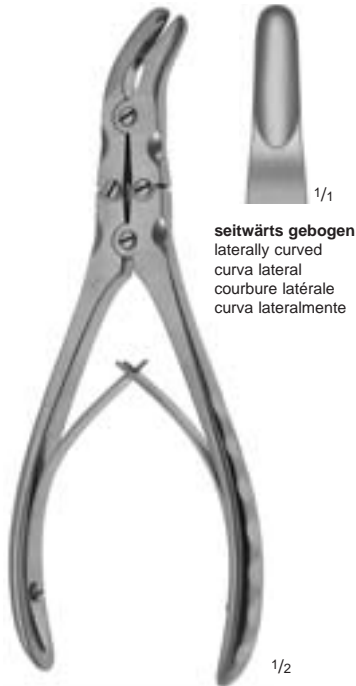

RUSKIN
38-0435
18 cm, 7"

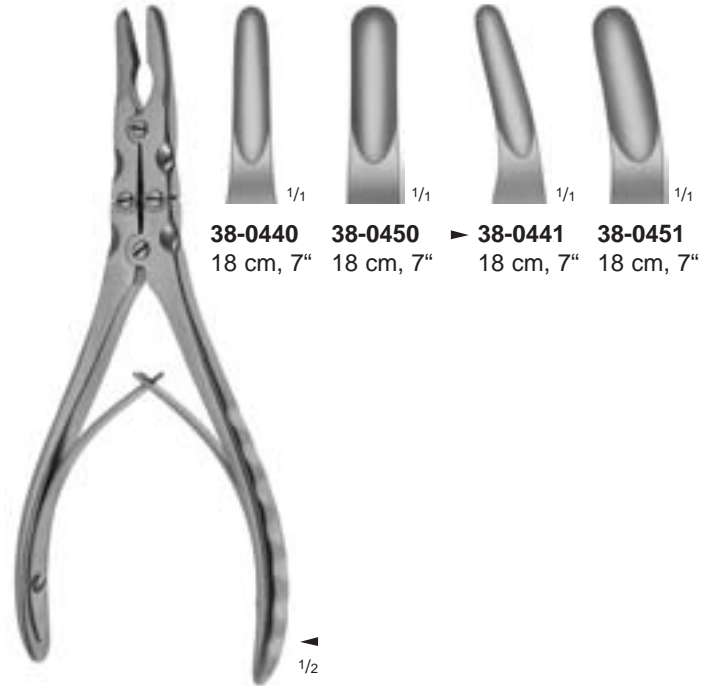

38-0440
18 cm, 7"

38-0450
18 cm, 7"

▶ **38-0441**
18 cm, 7"

38-0451
18 cm, 7"

RUSKIN
38-0440
- **38-0451**



Hohlmeißelzangen

Bone Rongeurs
Pinzas-gubias
Pincès-gouges
Pinze per ossa



MARQUARDT
45-0507
20 cm, 8"



38-0442
20,5 cm, 8"

▶ **38-0443**
20,5 cm, 8"

RUSKIN
38-0442
- **38-0443**

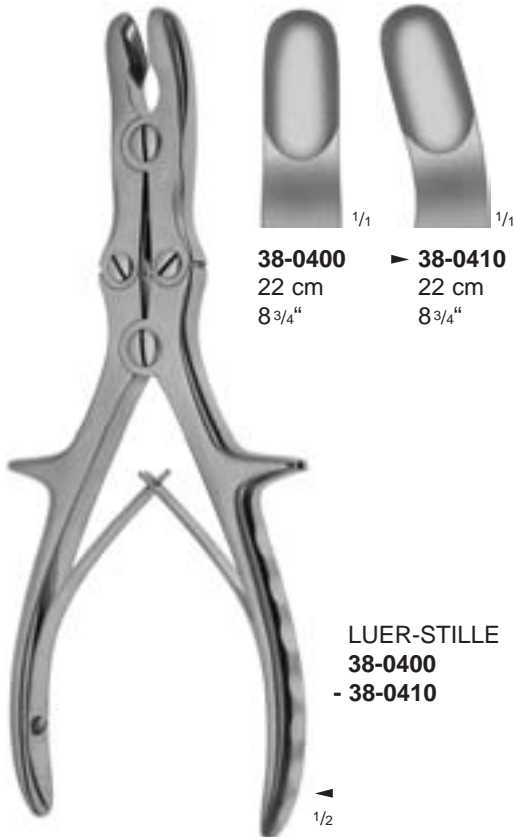

38-0400 ▶ **38-0410**
22 cm 22 cm
8 3/4" 8 3/4"

LUER-STILLE
38-0400
- **38-0410**

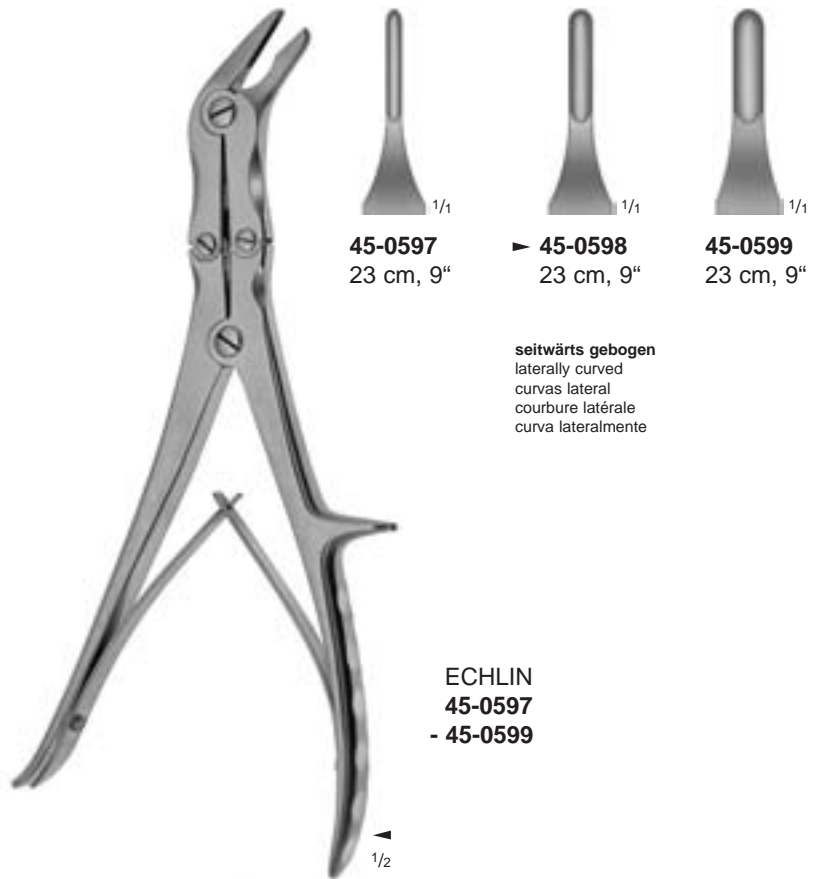

45-0597
23 cm, 9"

▶ **45-0598**
23 cm, 9"

45-0599
23 cm, 9"

seitwärts gebogen
laterally curved
curvas lateral
courbure latérale
curva lateralmente

ECHLIN
45-0597
- **45-0599**

Hohlmeißelzangen

Bone Rongeurs

Pinzas-gubias

Pinces-gouges

Pinze per ossa



38-0501

24,5 cm, 9³/₄"

▶ **38-0500**

24,5 cm, 9³/₄"

38-0503

24 cm, 9¹/₂"

▶ **38-0502**

24 cm, 9¹/₂"



STILLE

38-0425

23 cm, 9"

seitwärts gebogen
laterally curved
curvas lateral
courbure latérale
curva lateralmente



LEKSELL-STILLE

38-0500

- **38-0501**

seitwärts gebogen
laterally curved
curvas lateral
courbure latérale
curva lateralmente



FRYKHOLM

38-0502

- **38-0503**

seitwärts gebogen
laterally curved
curvas lateral
courbure latérale
curva lateralmente



Hohlmeißelzangen

Bone Rongeurs

Pinzas-gubias

Pinces-gouges

Pinze per ossa



1/1



1/1



1/1



1/1



1/1

38-0405
25 cm, 10"

▶ **38-0415**
25 cm, 10"



1/2

STILLE-RUSKIN
38-0455
23,5 cm, 9 1/4"



1/2

RÖTTGEN-RUSKIN
38-0460
24 cm, 9 1/2"



1/2

LUER-STILLE
38-0405
- **38-0415**



1/2

LUER-STILLE
38-0703
27 cm, 10 3/4"

Knochensplitterzangen

Bone Cutting Forceps

Pinzas cortantes para huesos

Pinces coupantes

Cesoie per ossa



LITTAUER-LISTON
45-0430
15,5 cm, 6"



KAZANJIAN
78-0120
18,5 cm, 7 1/4"



CLEVELAND
45-0431
15 cm, 6"

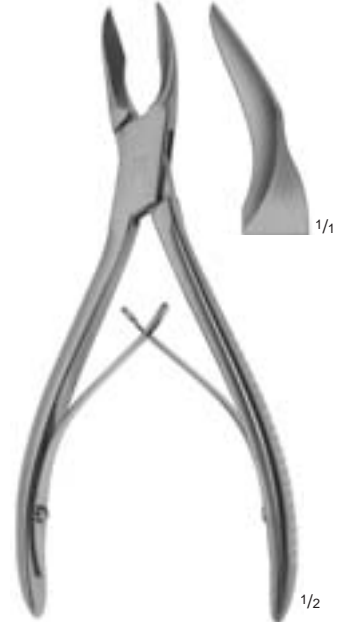

CLEVELAND
45-0433
17 cm, 6 3/4"



LISTON
45-0400
- 45-0406

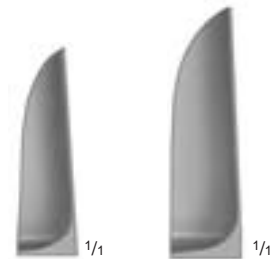

45-0400
14 cm
5 1/2"

45-0402
17 cm
6 3/4"



45-0404
19,5 cm
7 3/4"

45-0406
22 cm
8 3/4"



LISTON
45-0410
- 45-0416

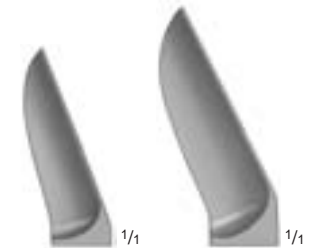

45-0410
14 cm
5 1/2"

45-0412
17 cm
6 3/4"

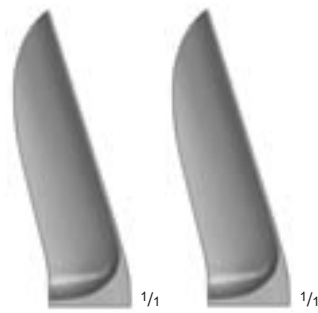

45-0414
19,5 cm
7 3/4"

45-0416
22 cm
8 3/4"



Knochensplitterzangen

Bone Cutting Forceps

Pinzas cortantes para huesos

Pinces coupantes

Cesoie per ossa



WALTON-LISTON (BÖHLER)
45-0428
14,5 cm, 5³/₄"



WALTON-LISTON (BÖHLER)
45-0429
14,5 cm, 5³/₄"



MC INDOE
45-0485
17,5 cm, 7"



RUSKIN
38-0470
18 cm, 7"



RUSKIN
38-0471
18 cm, 7"



RUSKIN-LISTON
45-0490
18,5 cm, 7¹/₄"

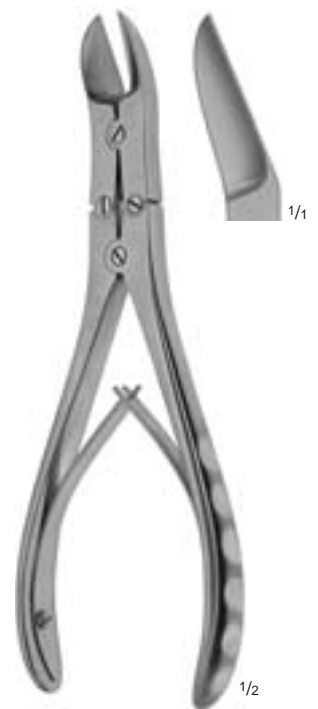

RUSKIN-LISTON
45-0491
18,5 cm, 7¹/₄"

Knochensplitterzangen

Bone Cutting Forceps

Pinzas cortantes para huesos

Pinces coupantes

Cesoie per ossa



LISTON
38-0345
24 cm, 9 1/2"



LISTON
38-0350
27 cm, 10 3/4"



LISTON
38-0355
27 cm, 10 3/4"



Meniskus- und Knorpelfaßzangen

Meniscus and Cartilage Grasping Forceps

Pinzas para menisco y cartilago

Pinces à ménisque et cartilage

Pinza da presa per menisco e cartillagine

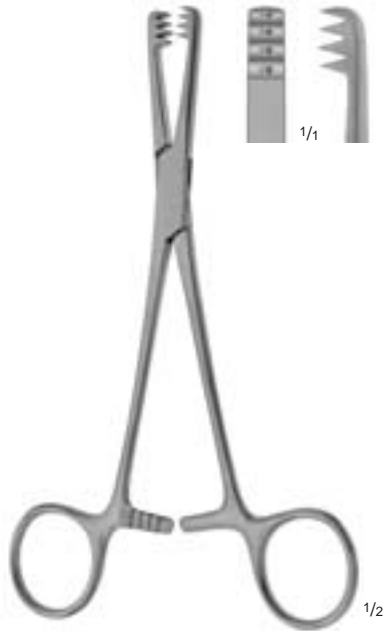

MARTIN
48-0400
16,5 cm, 6 1/2"



MARTIN
48-0405
18,5 cm, 7 1/4"



MARTIN
48-0406
20,5 cm, 8"

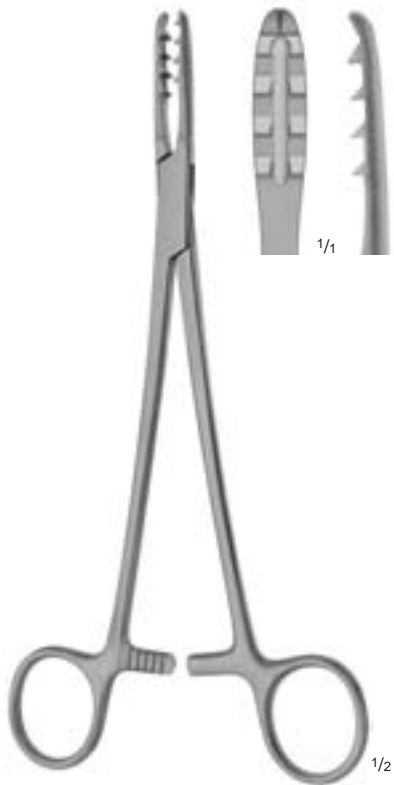

BIRCHER-GANSKE
48-0412
20,5 cm, 8"



BIRCHER-GANSKE
48-0415
20,5 cm, 8"

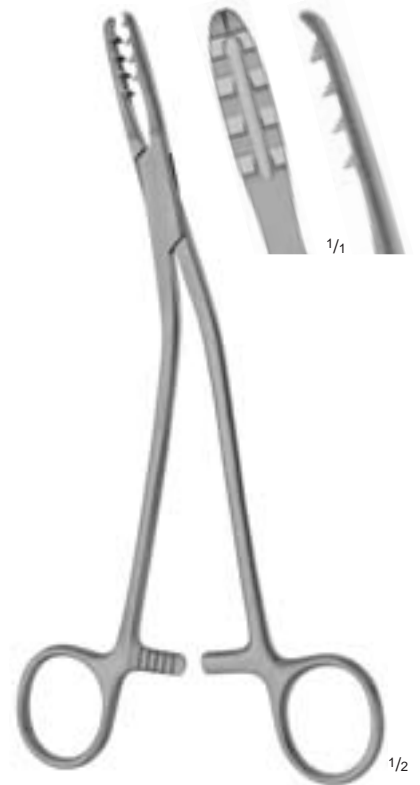

BIRCHER-GANSKE
48-0416
20,5 cm, 8"

Wund- und Meniskushaken

Retractors for Knee
 Separadores para rodilla
 Ecarteurs pour genou
 Retrattori per ginocchio

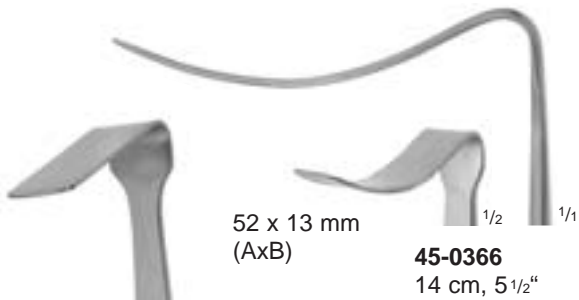
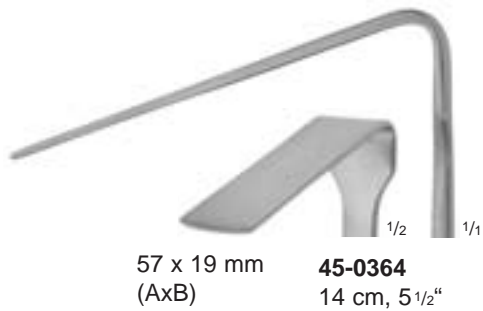
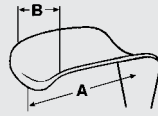

SMILLIE
45-0360
 - **45-0368**

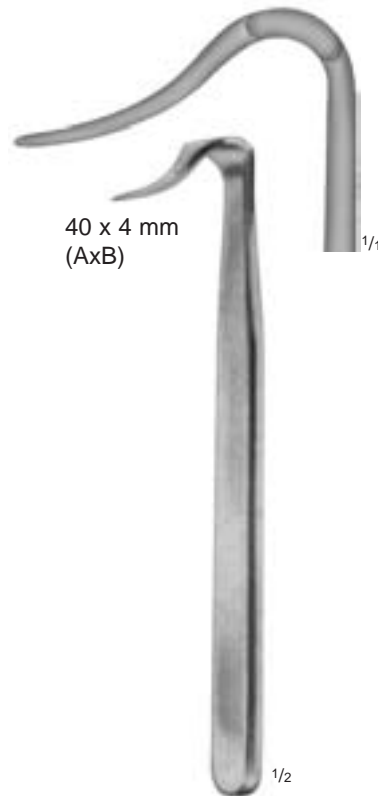
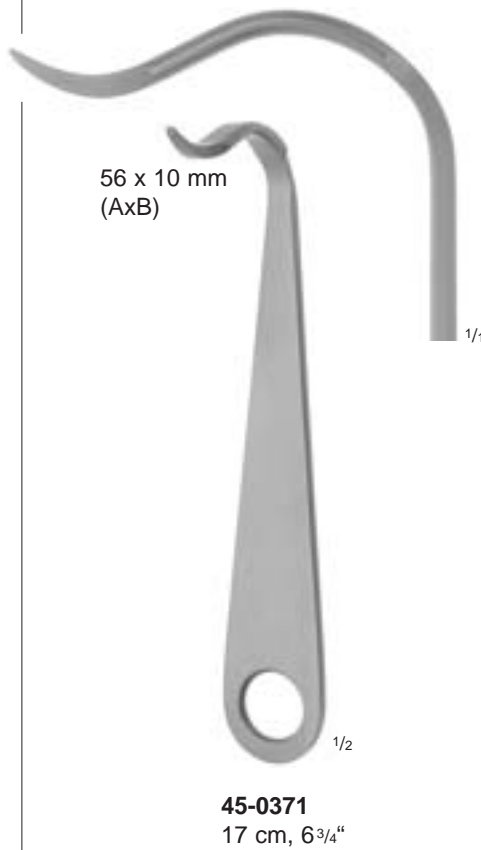

BLOUNT
45-0375
 17,5 cm, 7"



45-0370
 21 cm, 8 1/4"



Meniskusmesser

Meniscus Knives
Bisturíes para menisco
Bistouris à ménisque
Bisturi per menisco

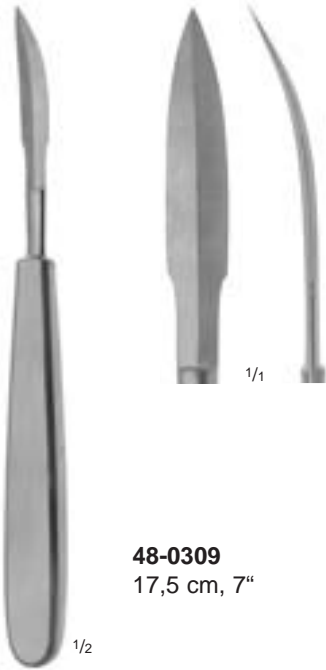

48-0309
17,5 cm, 7"

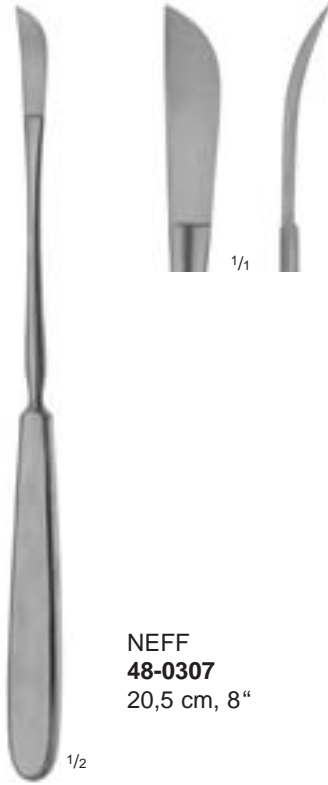

NEFF
48-0307
20,5 cm, 8"

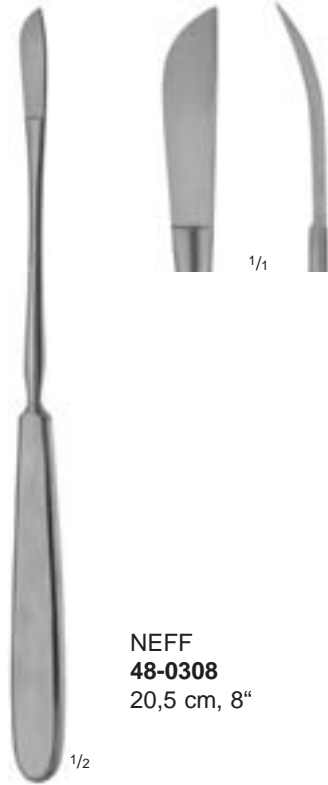

NEFF
48-0308
20,5 cm, 8"

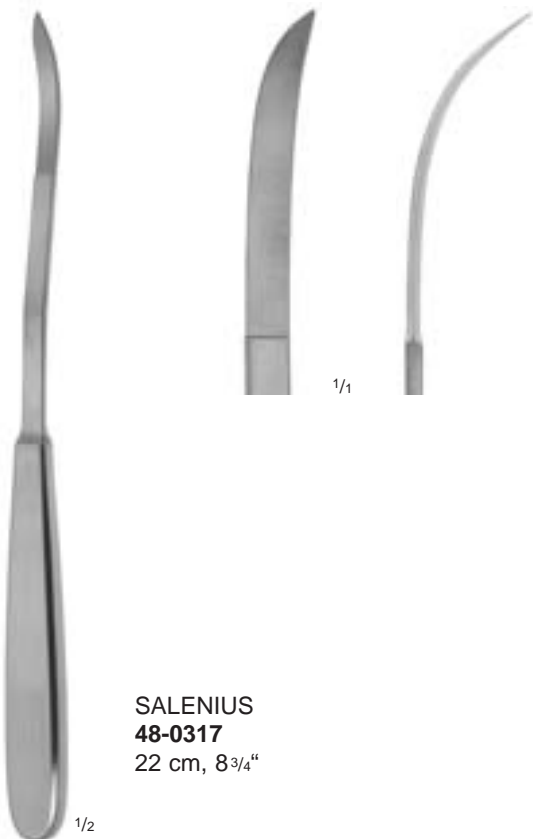

SALENIUS
48-0317
22 cm, 8³/₄"

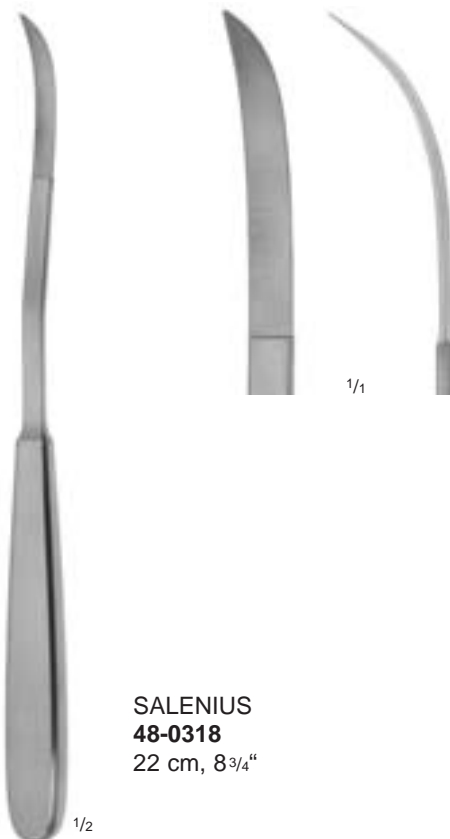

SALENIUS
48-0318
22 cm, 8³/₄"

Meniskusmesser

Meniscus Knives

Bisturíes para menisco

Bistouris à ménisque

Bisturi per menisco

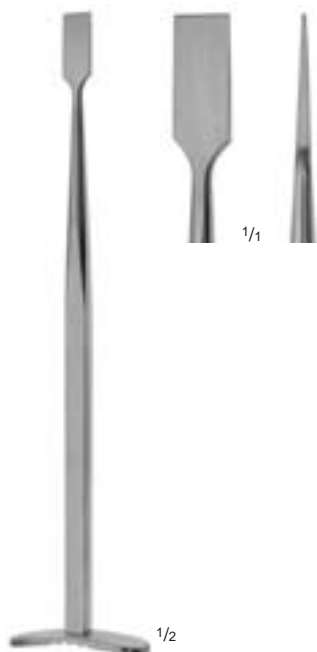

SMILLIE
48-0310
17 cm, 6³/₄"

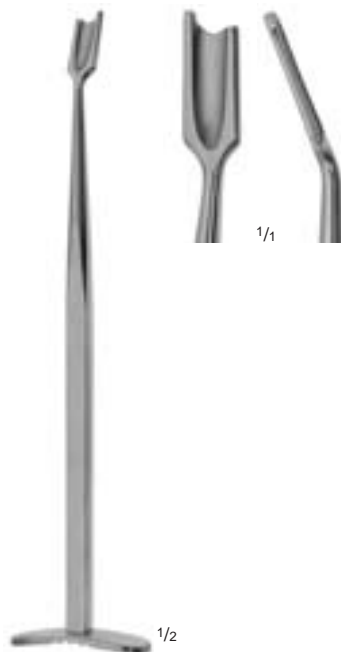

SMILLIE
48-0311
17 cm, 6³/₄"

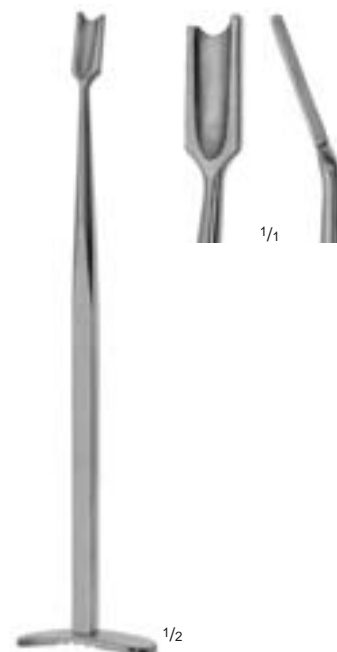

SMILLIE
48-0312
17 cm, 6³/₄"



CANAD. MODELL
48-0331
20,5 cm, 8"



CANAD. MODELL
48-0330
20,5 cm, 8"



BIRCHER
48-0332
19 cm, 7¹/₂"



BIRCHER
48-0333
19 cm, 7¹/₂"



Bleihände

Lead Hands
Manos de plomo
Main de plomb
Mano di piombo

Handhalter

Handrestrainer
Sujetadores de mano
Mains de plomb
Protezione della mano



► **48-0339**
24,5 cm, 9^{3/4}“

für Kinder
for children
para niños
pour enfants
per bambini

48-0340
37 cm, 14^{1/2}“

für Erwachsene
for adults
para adultos
pour adultes
per adulti

Bleihände. Durch Umbiegen der Lappen werden Hand und Finger in Operationslage festgehalten und durch das Gewicht der Bleihand zusätzlich immobilisiert.

Lead hands. Hand and fingers are secured by bending the lateral fixation process and further fixed by weight of lead hand.

Manos de plomo. Doblando los lóbulos se sujeta la mano y los dedos en posición para operar, y se queda también inmóvil por el peso de la mano de plomo.

Mains de plomb. En pliant les lambeaux, la main et les doigts sont fixés en position d'opération et immobilisés grâce au poids de la main en plomb.

Mano di piombo. Legando i lobi, la mano e le dita si assestano in posizione da poter operare grazie al peso della mano di piombo.



VICKERS
48-0341
25 cm, 10“

Handhalter. Schnelles und sicheres Fixieren von Hand, Daumen und Fingern. Finger können seitlich nicht entweichen. Mehrfache Halterungen für Gummiband-Retraktoren.

Handrestrainer. Rapid application and release hand, thumb and individual fingers. Digits cannot escape sideways. Multipoint rubber band anchorages for varied postures.

Sujetador de mano. Aplicación rápida y segura de la mano, del pulgar y de los dedos. Los dedos no se pueden escapar lateralmente. Fijadores múltiples para retractoros de cintas elásticas.

Support de main. Fixation rapide et en sécurité de la main, du pouce et des doigts. Les doigts ne peuvent échapper. Plusieurs supports pour rétracteurs en bandes élastiques.

Supporto-mano. Di rapida applicazione e di sollievo per la mano, pollice e dita individuali. Le dita non possono andare lateralmente munito di varie fasce di gomma per l'ancoraggio in diverse posizioni.

Fingerringsägen

Finger Ring Saws
Sierras para abrir anillos
Scies pour bagues
Seghe per anelli

Fingernagel-Instrumente

Finger Nail Instruments
Instrumentos para uñas
Instruments à ongles
Strumenti per unghie



19-0140
16 cm, 6 1/4"

Fingerringsäge
Finger ring saw
Sierra para abrir anillos
Scie pour bagues
Segha per anelli



19-0141

Ersatzsägeblatt
Spare saw blade
Hoja de repuesto
Lame de scie de rechange
Lama di ricambio per sega



19-0145
16,5 cm, 6 1/2"

Fingerringsäge
Finger ring saw
Sierra para abrir anillos
Scie pour bagues
Segha per anelli



19-0146

Ersatzsägeblatt
Spare saw blade
Hoja de repuesto
Lame de scie de rechange
Lama di ricambio per sega

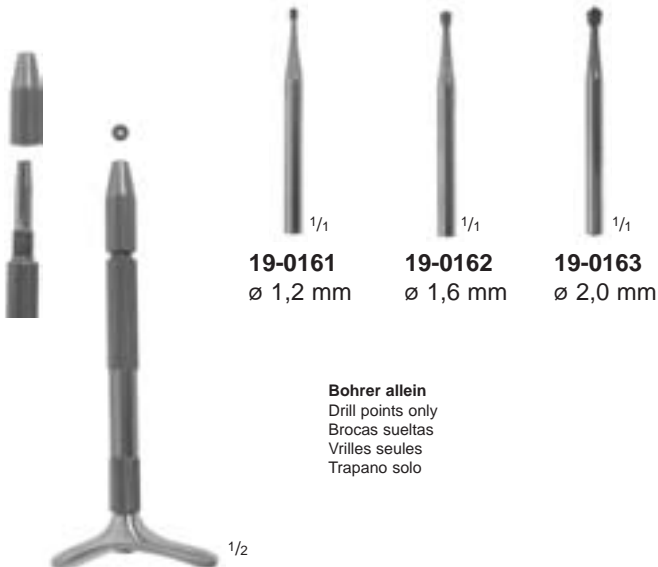

19-0160

Nagelbohrer, komplett, mit Griff und 3 Bohrern
Finger nail drill, complete, with handle and 3 drill points
Taladro para uñas, completo, con mango y 3 brocas
Perceuse à ongles, complète, avec manche et 3 vrilles
Ghiaccia unghie, completo, con manico e 3 di sondaggio

19-0161
ø 1,2 mm

19-0162
ø 1,6 mm

19-0163
ø 2,0 mm

Bohrer allein
Drill points only
Brocas sueltas
Vrilles seules
Trapano solo

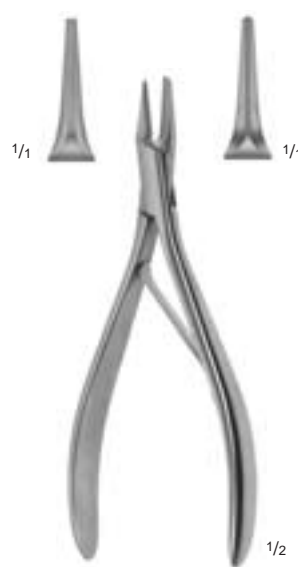

19-0467
13 cm, 5 1/8"

Nagelspaltzange
Nail splitting forceps
Pinza corta-uñas
Pinza à ongles
Pinza per unghie

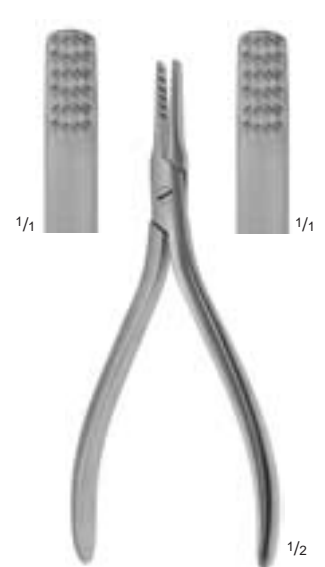

RADOLF
19-0470
13,5 cm, 5 1/4"

Nagelausreißzange
Nail extracting forceps
Pinza arranca-uñas
Pinza pour extraction des ongles
Pinza per estrazione delle unghie



Sehenschäler

Tendon Strippers
Mondador de tendones
Strippers à tendons
Enucleatore per tendine

Sehnenführer

Tendon Passing Instruments
Conductor de tendones
Conducteurs à tendons
Guida per tendine



48-0351
ø 3 mm



▶ **48-0352**
ø 4 mm



48-0353
ø 5 mm



48-0354
ø 6 mm



48-0355
ø 7 mm



BUNNELL
48-0351
- **48-0355**
15 cm, 6"

Sehenschäler
Tendon strippers
Mondador de tendones
Strippers à tendons
Enucleatore per tendine



48-0376
ø 4,0 mm



▶ **48-0377**
ø 4,5 mm



48-0378
ø 5,5 mm



48-0376
- **48-0378**
23 cm, 9"

Sehenschäler, Schaft biegsam
Tendon strippers, malleable shaft
Mondador de tendones, vástago maleable
Strippers à tendons, malléables
Enucleatore per tendine, asse malleabile

ø 4 mm



FISCHER
48-0379
31 cm, 12 1/4"

Sehenschäler
Tendon stripper
Mondador de tendones
Stripper à tendons
Enucleatore per tendine

ø 5 mm



BUNNELL
48-0360
23 cm, 9"

Sehnenführer, Schaft biegsam
Tendon passing instrument, malleable shaft
Conductor de tendones, vástago maleable
Conducteur à tendons, malléable
Guida per tendine, asse malleabile

ø 5,5 mm



48-0364
Schraube allein
screw only
tornillo suelto
vis seul
vite solo

48-0363
33,5 cm, 13 1/4"

Sehnenführer und Tunnelierinstrument, Schaft biegsam
Tendon passing and tunneling instrument, malleable shaft
Conductor de tendones e instrumento para el tunel del tendón, vástago maleable
Conducteur et tunelisateur à tendons, malléable
Strumento guida e per scanalare, asse maleabile

Sehnenfaßzangen

Tendon Seizing Forceps

Pinzas para agarrar el tendón

Pinces à saisir les tendons

Pinze per la presa del tendine

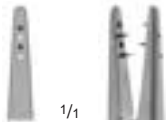

1/1

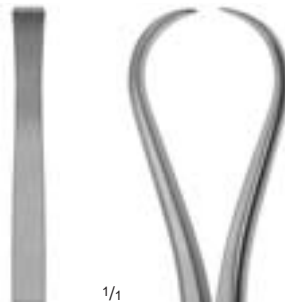

1/1

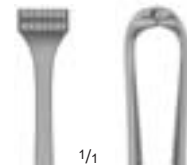

1/1



1/2

48-0380
11,5 cm, 4 1/2"



1/2

JACKSON
48-0382
15,5 cm, 6"
4 x 5 Zähne
4 x 5 teeth
4 x 5 dientes
4 x 5 dent
4 x 5 denti



1/2

STEINMANN
48-0384
15,5 cm, 6"



Sehnenführungszangen
 Tendon Holding Forceps
 Pinzas-conductoras de tendón
 Conducteurs à tendons
 Pinze ferma tendine





CARROLL
48-0388

Nutzlänge: 11 cm, 4 3/8"
 Working length: 11 cm, 4 3/8"
 Longitud útil: 11 cm, 4 3/8"
 Longueur utile: 11 cm, 4 3/8"
 Lunghezza di lavoro: 11 cm, 4 3/8"



 1/1
48-0424
 15 cm, 6"

 1/1
48-0425
 19 cm, 7 1/2"

 1/1
 ▶ **48-0426**
 24 cm, 9 1/2"

BRAND
48-0424
 - 48-0426



 1/1
48-0427
 15 cm, 6"

 1/1
48-0428
 19 cm, 7 1/2"

 1/1
 ▶ **48-0429**
 24 cm, 9 1/2"

BRAND
48-0427
 - 48-0429

Sehndurchziehungen

Tendon Passing Forceps
Pinzas para pasar tendones
Pinces passe-tendons
Pinze passa tendine

Sehneneinflechtungen

Tendon Interlacing Forceps
Pinzas para entrelazar tendones
Pinces pour entrelacer les tendons
Pinze per allacciare tendini

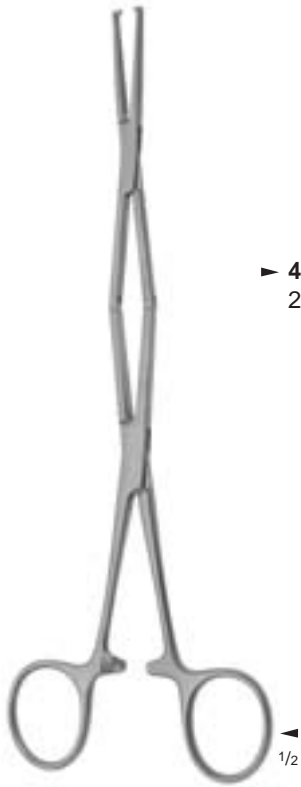

► **48-0460**
20,5 cm, 8"

48-0461
20,5 cm, 8"

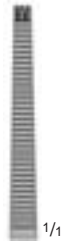

48-0460
- **48-0461**

Sehndurchziehungen
Tendon passing forceps
Pinzas para pasar tendones
Pinces passe-tendons
Pinze passa tendine



KLEINERT-KUTZ
48-0463
20,5 cm, 8"

Sehndurchziehungen
Tendon passing forceps
Pinza para pasar tendones
Pince passe-tendons
Pinza passa tendine



48-0464
15 cm, 6"

Sehneneinflechtungen
Tendon interlacing forceps
Pinza para entrelazar tendones
Pince pour entrelacer les tendons
Pinza per intrecciare tendini



48-0465
15 cm, 6"

Sehneneinflechtungen
Tendon interlacing forceps
Pinza para entrelazar tendones
Pince pour entrelacer les tendons
Pinza per intrecciare tendini

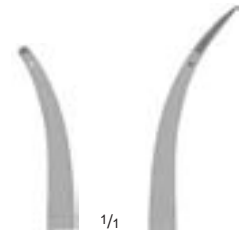



Bohrerführungsinstrument

Drill Guide Forceps
Pinza-guía para taladros
Pincés-guides
Pinze guida sonda

Reibahlen

Reamers
Escariadores
Pointes-carrées
Punteruoli

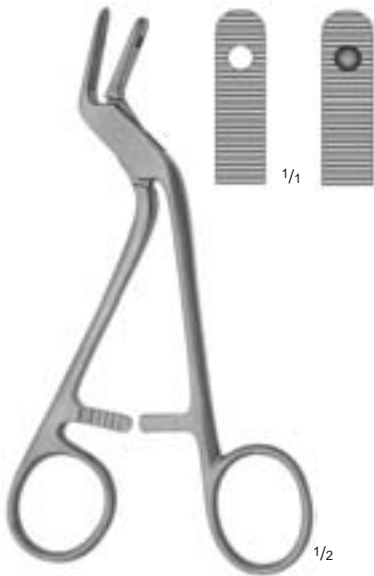

ADSON
50-0190
15 cm, 6"

Bohrerführungs- und Dura-Schutzzange
Drill guide and dura protecting forceps
Pinza-guía para taladros y para proteger la dura-madre
Pince-guide et pour protéger la dure-mère
Pinza guida sonda e per la protezione della dura-madre



48-1019
13 cm, 5 1/8"

Reibahle
Reamer
Escariador
Pointe-carrée
Punteruolo



48-1020
16 cm, 6 1/4"

Reibahle
Reamer
Escariador
Pointe-carrée
Punteruolo



48-1023
14 cm, 5 1/2"

Reibahle
Reamer
Escariador
Pointe-carrée
Punteruolo



PERTHES
48-1031
18,5 cm, 7 1/4"

Reibahle
Reamer
Escariador
Pointe-carrée
Punteruolo



PERTHES
48-1030
21 cm, 8 1/4"

Reibahle
Reamer
Escariador
Pointe-carrée
Punteruolo



PERTHES
48-1035
22 cm, 8 3/4"

Reibahle
Reamer
Escariador
Pointe-carrée
Punteruolo

Handbohrapparat

Hand Bone Drill

Perforador de mano

Perforateur à main

Trapano a mano per ossa

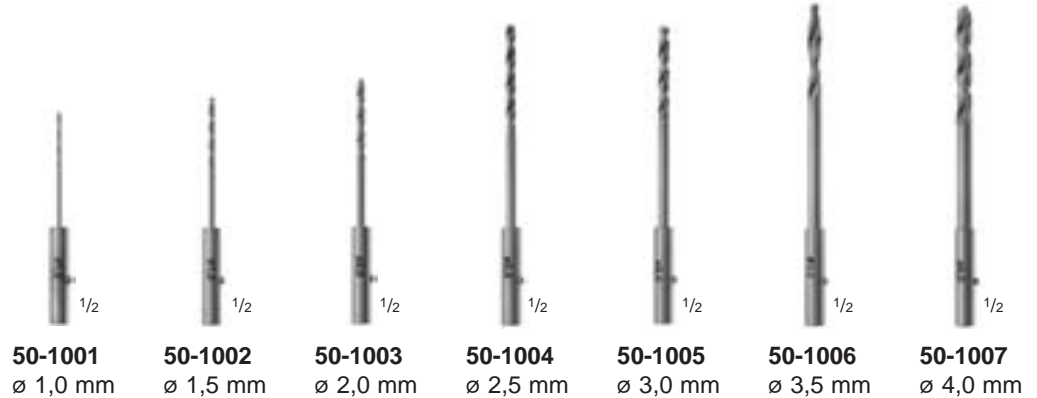

50-1001
ø 1,0 mm

50-1002
ø 1,5 mm

50-1003
ø 2,0 mm

50-1004
ø 2,5 mm

50-1005
ø 3,0 mm

50-1006
ø 3,5 mm

50-1007
ø 4,0 mm



50-0121

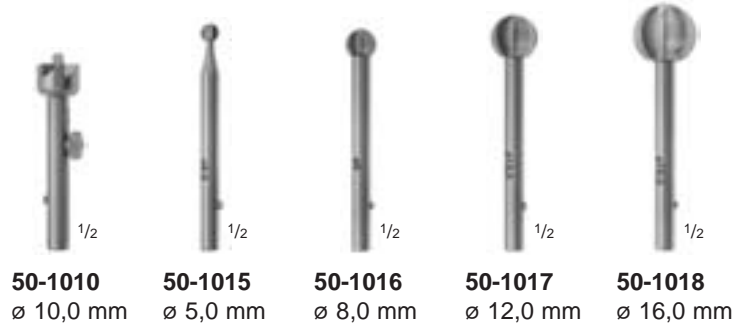

50-1010
ø 10,0 mm

50-1015
ø 5,0 mm

50-1016
ø 8,0 mm

50-1017
ø 12,0 mm

50-1018
ø 16,0 mm

Hand bone drill, complete, consisting of:

| | |
|---------|----------------------------|
| 50-0121 | 1 Hand bone drill |
| 50-1001 | 1 Twist drill ø 1,0 mm |
| 50-1002 | 1 Twist drill ø 1,5 mm |
| 50-1003 | 1 Twist drill ø 2,0 mm |
| 50-1004 | 1 Twist drill ø 2,5 mm |
| 50-1005 | 1 Twist drill ø 3,0 mm |
| 50-1006 | 1 Twist drill ø 3,5 mm |
| 50-1007 | 1 Twist drill ø 4,0 mm |
| 50-1010 | 1 Trephine ø 10,0 mm |
| 50-1015 | 1 Spherical burr ø 5,0 mm |
| 50-1016 | 1 Spherical burr ø 8,0 mm |
| 50-1017 | 1 Spherical burr ø 12,0 mm |
| 50-1018 | 1 Spherical burr ø 16,0 mm |

Perforador de mano, completo, compuesto de:

| | |
|---------|----------------------------|
| 50-0121 | 1 Perforador de mano |
| 50-1001 | 1 Taladro espiral ø 1,0 mm |
| 50-1002 | 1 Taladro espiral ø 1,5 mm |
| 50-1003 | 1 Taladro espiral ø 2,0 mm |
| 50-1004 | 1 Taladro espiral ø 2,5 mm |
| 50-1005 | 1 Taladro espiral ø 3,0 mm |
| 50-1006 | 1 Taladro espiral ø 3,5 mm |
| 50-1007 | 1 Taladro espiral ø 4,0 mm |
| 50-1010 | 1 Trépano ø 10,0 mm |
| 50-1015 | 1 Fresa esférica ø 5,0 mm |
| 50-1016 | 1 Fresa esférica ø 8,0 mm |
| 50-1017 | 1 Fresa esférica ø 12,0 mm |
| 50-1018 | 1 Fresa esférica ø 16,0 mm |

STILLE

50-0120

Handbohrapparat, komplett, bestehend aus:

| | |
|---------|-------------------------|
| 50-0121 | 1 Handbohrapparat |
| 50-1001 | 1 Spiralbohrer ø 1,0 mm |
| 50-1002 | 1 Spiralbohrer ø 1,5 mm |
| 50-1003 | 1 Spiralbohrer ø 2,0 mm |
| 50-1004 | 1 Spiralbohrer ø 2,5 mm |
| 50-1005 | 1 Spiralbohrer ø 3,0 mm |
| 50-1006 | 1 Spiralbohrer ø 3,5 mm |
| 50-1007 | 1 Spiralbohrer ø 4,0 mm |
| 50-1010 | 1 Trephine ø 10,0 mm |
| 50-1015 | 1 Kugelfräser ø 5,0 mm |
| 50-1016 | 1 Kugelfräser ø 8,0 mm |
| 50-1017 | 1 Kugelfräser ø 12,0 mm |
| 50-1018 | 1 Kugelfräser ø 16,0 mm |

Perforateur à main, complet, composé de:

| | |
|---------|-------------------------------|
| 50-0121 | 1 Perforateur à main |
| 50-1001 | 1 Mèche hélicoïdales ø 1,0 mm |
| 50-1002 | 1 Mèche hélicoïdales ø 1,5 mm |
| 50-1003 | 1 Mèche hélicoïdales ø 2,0 mm |
| 50-1004 | 1 Mèche hélicoïdales ø 2,5 mm |
| 50-1005 | 1 Mèche hélicoïdales ø 3,0 mm |
| 50-1006 | 1 Mèche hélicoïdales ø 3,5 mm |
| 50-1007 | 1 Mèche hélicoïdales ø 4,0 mm |
| 50-1010 | 1 Tréphine ø 10,0 mm |
| 50-1015 | 1 Fraise ø 5,0 mm |
| 50-1016 | 1 Sphérique ø 8,0 mm |
| 50-1017 | 1 Sphérique ø 12,0 mm |
| 50-1018 | 1 Sphérique ø 16,0 mm |

Trapano a mano per ossa, completo, composto da:

| | |
|---------|----------------------------|
| 50-0121 | 1 Trapano a mano |
| 50-1001 | 1 Punta a spirale ø 1,0 mm |
| 50-1002 | 1 Punta a spirale ø 1,5 mm |
| 50-1003 | 1 Punta a spirale ø 2,0 mm |
| 50-1004 | 1 Punta a spirale ø 2,5 mm |
| 50-1005 | 1 Punta a spirale ø 3,0 mm |
| 50-1006 | 1 Punta a spirale ø 3,5 mm |
| 50-1007 | 1 Punta a spirale ø 4,0 mm |
| 50-1010 | 1 Fresa ø 10,0 mm |
| 50-1015 | 1 Cilindrica ø 5,0 mm |
| 50-1016 | 1 Fresa sferica ø 8,0 mm |
| 50-1017 | 1 Fresa sferica ø 12,0 mm |
| 50-1018 | 1 Fresa sferica ø 16,0 mm |



Handbohrapparat

Hand Bone Drill

Perforador de mano

Perforateur à main

Trapano a mano per ossa



50-0141



50-0146



50-0142
ø 10 mm



50-0143
ø 14 mm



50-0144
ø 16 mm



50-0145
ø 22 mm

Hand bone drill, complete, consisting of:

50-0141 1 Hand bone drill
50-0146 1 Extension piece
50-0142 1 Burr ø 10 mm
50-0143 1 Burr ø 14 mm
50-0144 1 Burr ø 16 mm
50-0145 1 Burr ø 22 mm
50-0147 1 Wooden box

Perforador de mano, completo, compuesto de:

50-0141 1 Perforador de mano
50-0146 1 Pieza de prolongación
50-0142 1 Fresa ø 10 mm
50-0143 1 Fresa ø 14 mm
50-0144 1 Fresa ø 16 mm
50-0145 1 Fresa ø 22 mm
50-0147 1 Estuche de madera

HUDSON 50-0140

Handbohrapparat, komplett, bestehend aus:

50-0141 1 Handbohrapparat
50-0146 1 Verlängerungsstück
50-0142 1 Fräser ø 10 mm
50-0143 1 Fräser ø 14 mm
50-0144 1 Fräser ø 16 mm
50-0145 1 Fräser ø 22 mm
50-0147 1 Holzetui

Perforateur à main, complet, composé de:

50-0141 1 Perforateur à main
50-0146 1 Pièce de rallonge
50-0142 1 Fraise ø 10 mm
50-0143 1 Fraise ø 14 mm
50-0144 1 Fraise ø 16 mm
50-0145 1 Fraise ø 22 mm
50-0147 1 Boîte bois

Trapano a mano, completo, composto da:

50-0141 1 Trapano a mano
50-0146 1 Giunto di prolungamento
50-0142 1 Fresa ø 10 mm
50-0143 1 Fresa ø 14 mm
50-0144 1 Fresa ø 16 mm
50-0145 1 Fresa ø 22 mm
50-0147 1 Contenitore in legno



CUSHING
50-0107
ø 13 mm

Bohrer
Drill
Taladro
Perforateur
Punta



ADSON
50-0160
ø 2,4 mm

Spiralbohrer
Twist drill
Taladro espiral
Mèche hélicoïdale
Punta a spirale



MC KENZIE
50-0150
ø 13 mm

Fräser
Burr
Fresa
Fraise
Fresa



ERRICO
50-0151
ø 16 mm

Fräser
Burr
Fresa
Fraise
Fresa

Handbohrapparate

Hand Bone Drills

Perforadores de mano

Perforateurs à main

Trapani a mano per ossa



48-0612

16 cm, 6 1/4"

Handbohrfutter mit Dreibacken-Spannfutter und Spannschlüssel (48-0613), Spannweite bis ø 6,35 mm, längsdurchbohrt, zum Einschlagen und Extrahieren von Bohrdrähten und Nägeln.

Drilling chuck with three-jaw-chuck and key (48-0613), for shanks up to 6.35 mm diam., cannulated, for inserting and extracting wire drills and nails.

Mandril de tres mordazas con llave (48-0613), apertura hasta ø 6,35 mm, barrenado oblongo, para insertar y extraer agujas y clavos.

Perforateur à main avec 3 mâchoires et une clef (48-0613), passage jusqu'à ø 6,35 mm, cranté, pour poser et retirer les broches et les clous.

Trapano con mandrino a 3 ganasce e chiave (48-0613), per punte sopra i 6,35 mm di ø, tubolare, per inserire ed estrarre fili e chiodi.



48-0615

14 cm, 5 1/2"

Handbohrfutter mit Dreibacken-Spannfutter und Spannschlüssel (48-0616), Spannweite bis ø 3,95 mm, längsdurchbohrt, zum Einschlagen und Extrahieren von Bohrdrähten und Nägeln.

Drilling chuck with three-jaw-chuck and key (48-0616), for shanks up to 3.95 mm diam., cannulated, for inserting and extracting wire drills and nails.

Mandril de tres mordazas con llave (48-0616), apertura hasta ø 3,95 mm, barrenado oblongo, para insertar y extraer agujas y clavos.

Perforateur à main avec 3 mâchoires et une clef (48-0616), passage jusqu'à ø 3,95 mm, cranté, pour poser et retirer les broches et les clous.

Trapano con mandrino a 3 ganasce e chiave (48-0616), per punte sopra i 3,95 mm di ø, tubolare, per inserire ed estrarre fili e chiodi.



BUNNELL

48-0580

Handbohrapparat mit Dreibacken-Spannfutter und Spannschlüssel (48-0581), Spannweite bis ø 4 mm, längsdurchbohrt, zur Aufnahme von Bohrdrähten und Nägeln.

Hand drill with three-jaw-chuck and key (48-0581), for shanks up to 4 mm diam., cannulated, for taking wire drills and nails.

Perforador de mano con mandril de tres mordazas y llave (48-0581), apertura hasta ø 4 mm, barrenado oblongo, para agujas y clavos.

Perforateur à manivelle avec 3 mâchoires et une clef (48-0581), passage jusqu'à ø 4 mm, pour les broches et les clous.

Trapano a mano con mandrino a 3 ganasce e chiave (48-0581), per punte sopra i 4 mm di ø, tubolare, per inserire fili e chiodi.



RALK

48-0585

Handbohrapparat mit Dreibacken-Spannfutter und Spannschlüssel (48-0586), Spannweite bis ø 6,35 mm, längsdurchbohrt, zur Aufnahme von Bohrdrähten und Nägeln.

Hand drill with three-jaw-chuck and key (48-0586), for shanks up to 6.35 mm diam., cannulated, for taking wire drills and nails.

Perforador de mano con mandril de tres mordazas y llave (48-0586), apertura hasta ø 6,3 mm, barrenado oblongo, para agujas y clavos.

Perforateur à manivelle avec 3 mâchoires et une clef (48-0586), passage jusqu'à ø 6,35 mm, pour les broches et les clous.

Trapano a mano con mandrino a 3 ganasce e chiave (48-0586), per punte sopra i 6,35 mm di ø, tubolare, per inserire fili e chiodi.



STEINMANN Nägel
 STEINMANN Pins
 STEINMANN Clavos
 STEINMANN Clous
 Chiodi STEINMANN

Extensionsbügel
 Wire Traction Bows
 Etribos para extensión
 Etriers à extension
 Archi per trazione



STEINMANN

- 48-0620** ø 4 mm x 80 mm
- 48-0621** ø 4 mm x 100 mm
- 48-0622** ø 4 mm x 120 mm
- 48-0623** ø 4 mm x 140 mm
- 48-0624** ø 4 mm x 150 mm
- 48-0625** ø 4 mm x 160 mm
- 48-0626** ø 4 mm x 180 mm
- ▶ **48-0627** ø 4 mm x 200 mm
- 48-0628** ø 4 mm x 210 mm
- 48-0629** ø 4 mm x 250 mm

Nägel mit Trokarspitze und 3kant-Schaft, aus nichtrostendem Implantatstahl nach DIN 17443

Pins with trocar point and triangular shaft, material used for implants: stainless steel acc. to DIN 17443

Clavos con punta trocar y vástago triangular, de acero inoxidable para implantes, conforme a DIN 17443

Clou à pointe triangulaire utilisé comme implant, acier inox conforme à la norme DIN 17443

Chiodi con trocar a punta e albero triangolare, materiale usato per innesti, in acciaio inox, conforme alle norme DIN 17443

1/1

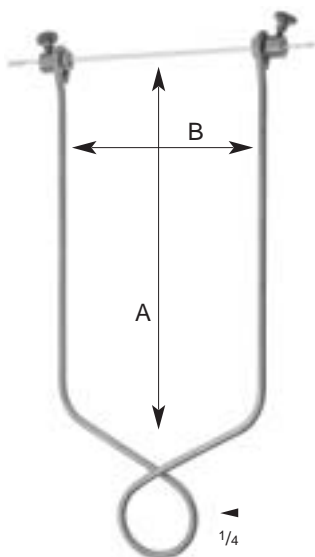

BÖHLER

- 48-0652**
- 160 x 190 mm
- 6 1/4" x 7 1/2" (AxB)

Extensionsbügel für Arm, zur Verwendung von STEINMANN Nägel ø 4 mm

Wire traction bow for arm, to be used with STEINMANN pins, 4 mm diam.

Estribo para extensión de brazo, para clavos de STEINMANN ø 4 mm

Etrier de traction pour bras, utilisé avec clou de STEINMANN ø 4 mm

Cavo per arco di trazione per braccio, da impiegarsi con chiodi STEINMANN, ø 4 mm

1/4

BÖHLER

- ▶ **48-0654**
- 210 x 110 mm
- 8 1/4" x 4 3/8" (AxB)

Extensionsbügel für Oberschenkel und Knie, zur Verwendung von STEINMANN Nägel ø 4 mm

Wire traction bow for thigh and knee, to be used with STEINMANN pins, 4 mm diam.

Estribo para extensión del muslo y de la rodilla, para clavos de STEINMANN ø 4 mm

Etrier de traction pour femur et genou, utilisé avec clou de STEINMANN ø 4 mm

Cavo per arco di trazione per coscia e ginocchio, da impiegarsi con chiodi STEINMANN, ø 4 mm

BÖHLER

- 48-0656**
- 210 x 150 mm
- 8 1/4" x 6" (AxB)

Extensionsbügel für Oberschenkel und Knie, zur Verwendung von STEINMANN Nägel ø 4 mm

Wire traction bow for thigh and knee, to be used with STEINMANN pins, 4 mm diam.

Estribo para extensión del muslo y de la rodilla, para clavos de STEINMANN ø 4 mm

Etrier de traction pour femur et genou, utilisé avec clou de STEINMANN ø 4 mm

Cavo per arco di trazione per coscia e ginocchio, da impiegarsi con chiodi STEINMANN, ø 4 mm

KIRSCHNER Bohrdrähte
 KIRSCHNER Wire Drills
 Agujas de KIRSCHNER
 Broches de KIRSCHNER
 Punte filiformi di KIRSCHNER



1/1

| | 15 cm, 6" | 31 cm, 12 1/4" |
|----------|------------------|----------------|
| ø 0,8 mm | 48-1708 | 48-1508 |
| ø 1,0 mm | 48-1710 | 48-1510 |
| ø 1,2 mm | 48-1712 | 48-1512 |
| ø 1,4 mm | 48-1714 | 48-1514 |
| ø 1,5 mm | 48-1715 | 48-1515 |
| ø 1,6 mm | 48-1716 | 48-1516 |
| ø 1,8 mm | 48-1718 | 48-1518 |
| ø 2,0 mm | ▶ 48-1720 | 48-1520 |
| ø 2,2 mm | 48-1722 | 48-1522 |
| ø 2,5 mm | 48-1725 | 48-1525 |
| ø 3,0 mm | 48-1727 | 48-1527 |

KIRSCHNER Bohrdrähte mit Trokarspitze und flachem Schaftende, aus nichtrostendem Implantatstahl nach DIN 17443, in Packungen zu 10 Stück
 KIRSCHNER Wire drills with trocar point and flat shaft end, material used for implants: stainless steel acc. to DIN 17443, in packages of 10 pieces
 Agujas de KIRSCHNER con punta trocar y cabo plano, de acero inoxidable para implantes, conforme a DIN 17443, en paquetes de 10 pzas.
 Broches KIRSCHNER avec 1 pointe trocar et 1 meplat, acier inox pour implant conforme à DIN 17443, en paquet de 10 pièces
 Punte di KIRSCHNER con trocar a punta ed estremita piatta, in acciaio inox impiegato per innesti, conforme alle norme DIN 17443, in confezioni da 10 pezzi



1/1

| | 15 cm, 6" | 31 cm, 12 1/4" |
|----------|------------------|----------------|
| ø 0,8 mm | 48-1828 | 48-1878 |
| ø 1,0 mm | 48-1830 | 48-1880 |
| ø 1,2 mm | 48-1832 | 48-1882 |
| ø 1,4 mm | 48-1834 | 48-1884 |
| ø 1,5 mm | 48-1835 | 48-1885 |
| ø 1,6 mm | 48-1836 | 48-1886 |
| ø 1,8 mm | 48-1838 | 48-1888 |
| ø 2,0 mm | ▶ 48-1840 | 48-1890 |
| ø 2,2 mm | 48-1842 | 48-1892 |
| ø 2,5 mm | 48-1845 | 48-1895 |
| ø 3,0 mm | 48-1847 | 48-1897 |

KIRSCHNER Bohrdrähte mit Trokarspitze und rundem Schaftende, aus nichtrostendem Implantatstahl nach DIN 17443, in Packungen zu 10 Stück
 KIRSCHNER Wire drills with trocar point and round shaft end, material used for implants: stainless steel acc. to DIN 17443, in packages of 10 pieces
 Agujas de KIRSCHNER con punta trocar y cabo redondo, de acero inoxidable para implantes, conforme a DIN 17443, en paquetes de 10 pzas.
 Broches KIRSCHNER avec 1 pointe trocar et 1 pointe mousse, acier inox pour implant conforme à DIN 17443, en paquet de 10 pièces
 Punte di KIRSCHNER con trocar a punta ed estremita rotonda, in acciaio inox impiegato per innesti, conforme alle norme DIN 17443, in confezioni da 10 pezzi



1/1

| | 10 cm, 4" | 15 cm, 6" | 31 cm, 12 1/4" |
|----------|------------------|----------------|----------------|
| ø 0,8 mm | 48-2038 | 48-2058 | 48-2078 |
| ø 1,0 mm | 48-2040 | 48-2060 | 48-2080 |
| ø 1,2 mm | 48-2042 | 48-2062 | 48-2082 |
| ø 1,4 mm | 48-2044 | 48-2064 | 48-2084 |
| ø 1,5 mm | 48-2045 | 48-2065 | 48-2085 |
| ø 1,6 mm | 48-2046 | 48-2066 | 48-2086 |
| ø 1,8 mm | 48-2048 | 48-2068 | 48-2088 |
| ø 2,0 mm | ▶ 48-2050 | 48-2070 | 48-2090 |
| ø 2,2 mm | 48-2052 | 48-2072 | 48-2092 |
| ø 2,5 mm | 48-2055 | 48-2075 | 48-2095 |
| ø 3,0 mm | 48-2057 | 48-2077 | 48-2097 |

KIRSCHNER Bohrdrähte mit beidseitiger Trokarspitze, aus nichtrostendem Implantatstahl nach DIN 17443, in Packungen zu 10 Stück
 KIRSCHNER Wire drills with trocar point on each end, material used for implants: stainless steel acc. to DIN 17443, in packages of 10 pieces
 Agujas de KIRSCHNER con dos puntas trocar, de acero inoxidable para implantes, conforme a DIN 17443, en paquetes de 10 pzas.
 Broches KIRSCHNER avec 2 pointes trocar, acier inox pour implant conforme à DIN 17443, en paquet de 10 pièces
 Punte di KIRSCHNER con trocar a punta su ciascun lato, in acciaio inox impiegato per innesti, conforme alle norme DIN 17443, in confezione da 10 pezzi



Bohrdrahtspender

Wire Drill Dispenser

Dispensador de agujas

Distributeur de broches

Distributore per punte filiformi

- **Sicherer Transport und schonende Lagerung.**
Perforierter Bohrdrahtspender für sichere Sterilisation.
Klar gekennzeichnete Bohrdrahtspender für jede Bohrdrahtstärke.
- Easy to transport and safely to storage.
Perforated dispenser for guaranteed sterilization.
Labelled wire dispenser for all diameters available.
- Transporte y almacenaje cuidadoso.
Dispensador perforado para la esterilización segura.
Dispensador indicando claramente cada diámetro.
- Facile à transporter et stocker.
Perforations diverses pour garantir la stérilisation.
Distributeur d'étiquettes pour tous diamètres disponibles.
- Facili da trasportare e conservare.
Contenitore forato per garantire la sterilizzazione.
Distributore marcato per i diametri disponibili.



für Bohrdraht \varnothing x Bohrdrahtlänge
for wire \varnothing x wire length
para aguja de \varnothing x longitud de la aguja
pour broches Kirschner \varnothing x longueur de broches
per \varnothing punta e lunghezza punta

| | |
|-----------|-------------------------------|
| ► 48-2158 | \varnothing 0,8 mm x 150 mm |
| 48-2160 | \varnothing 1,0 mm x 150 mm |
| 48-2162 | \varnothing 1,2 mm x 150 mm |
| 48-2164 | \varnothing 1,4 mm x 150 mm |
| 48-2165 | \varnothing 1,5 mm x 150 mm |
| 48-2166 | \varnothing 1,6 mm x 150 mm |
| 48-2168 | \varnothing 1,8 mm x 150 mm |
| 48-2170 | \varnothing 2,0 mm x 150 mm |
| 48-2172 | \varnothing 2,2 mm x 150 mm |
| 48-2175 | \varnothing 2,5 mm x 150 mm |
| 48-2177 | \varnothing 3,0 mm x 150 mm |



für Bohrdraht \varnothing x Bohrdrahtlänge
for wire \varnothing x wire length
para aguja de \varnothing x longitud de la aguja
pour broches Kirschner \varnothing x longueur de broches
per \varnothing punta e lunghezza punta

| | |
|-----------|-------------------------------|
| 48-2178 | \varnothing 0,8 mm x 310 mm |
| 48-2180 | \varnothing 1,0 mm x 310 mm |
| ► 48-2182 | \varnothing 1,2 mm x 310 mm |
| 48-2184 | \varnothing 1,4 mm x 310 mm |
| 48-2185 | \varnothing 1,5 mm x 310 mm |
| 48-2186 | \varnothing 1,6 mm x 310 mm |
| 48-2188 | \varnothing 1,8 mm x 310 mm |
| 48-2190 | \varnothing 2,0 mm x 310 mm |
| 48-2192 | \varnothing 2,2 mm x 310 mm |
| 48-2195 | \varnothing 2,5 mm x 310 mm |
| 48-2197 | \varnothing 3,0 mm x 310 mm |

Mehrfach-Bohrdrahtspender

Multiple Wire Drill Dispenser

Dispensador de agujas

Distributeur de broches filiformes

Distributore multiplo per punte filiformi



- Vier verschiedene Bohrdrähte in einem Spender.
Eindeutige Kennzeichnung der verschiedenen Durchmesser auf dem Spender.
Sterilisation und Aufbewahrung im Spender.
- Four different wire drills from one dispenser.
Clear size markings on the dispenser.
Sterilization and storage in the dispenser.
- Cuatro agujas distintas en un sólo dispensador.
El dispensador está marcado claramente con los diferentes diámetros.
Esterilización y almacenaje dentro del mismo dispensador.
- 4 différentes broches filiformes dans un distributeur.
Marquage exacte des différents diamètres sur le distributeur.
Stérilisation et conservation dans le distributeur.
- 4 differenti punte filiformi e un solo contenitore
Distributore marcato con i vari diametri
Sterilizzazione e conservazione nello stesso distributore



VICKERS 48-2108

für Bohrdrähte \varnothing 1,0/1,2/1,4/1,6 mm x 100 mm
for wire drills \varnothing 1.0/1.2/1.4/1.6 mm x 100 mm
para agujas de diámetro 1,0/1,2/1,4/1,6 mm x 100 mm
pour broches filiformes \varnothing 1,0/1,2/1,4/1,6 mm x 100 mm
per punte filiformi \varnothing 1,0/1,2/1,4/1,6 mm x 100 mm



► 48-2100

für Bohrdrähte \varnothing 1,0/1,2/1,4/1,6 mm x 150 mm
for wire drills \varnothing 1.0/1.2/1.4/1.6 mm x 150 mm
para agujas de diámetro 1,0/1,2/1,4/1,6 mm x 150 mm
pour broches filiformes \varnothing 1,0/1,2/1,4/1,6 mm x 150 mm
per punte filiformi \varnothing 1,0/1,2/1,4/1,6 mm x 150 mm



► 48-2104

für Bohrdrähte \varnothing 1,0/1,2/1,4/1,6 mm x 310 mm
for wire drills \varnothing 1.0/1.2/1.4/1.6 mm x 310 mm
para agujas de diámetro 1,0/1,2/1,4/1,6 mm x 310 mm
pour broches filiformes \varnothing 1,0/1,2/1,4/1,6 mm x 310 mm
per punte filiformi \varnothing 1,0/1,2/1,4/1,6 mm x 310 mm

48-2102

für Bohrdrähte \varnothing 1,8/2,0/2,2/2,5 mm x 150 mm
for wire drills \varnothing 1.8/2.0/2.2/2.5 mm x 150 mm
para agujas de diámetro 1,8/2,0/2,2/2,5 mm x 150 mm
pour broches filiformes \varnothing 1,8/2,0/2,2/2,5 mm x 150 mm
per punte filiformi \varnothing 1,8/2,0/2,2/2,5 mm x 150 mm

48-2106

für Bohrdrähte \varnothing 1,8/2,0/2,2/2,5 mm x 310 mm
for wire drills \varnothing 1.8/2.0/2.2/2.5 mm x 310 mm
para agujas de diámetro 1,8/2,0/2,2/2,5 mm x 310 mm
pour broches filiformes \varnothing 1,8/2,0/2,2/2,5 mm x 310 mm
per punte filiformi \varnothing 1,8/2,0/2,2/2,5 mm x 310 mm



Extensionsbügel
Wire Traction Bows
Estribos para extensión
Etriers à extension
Archi per trazione

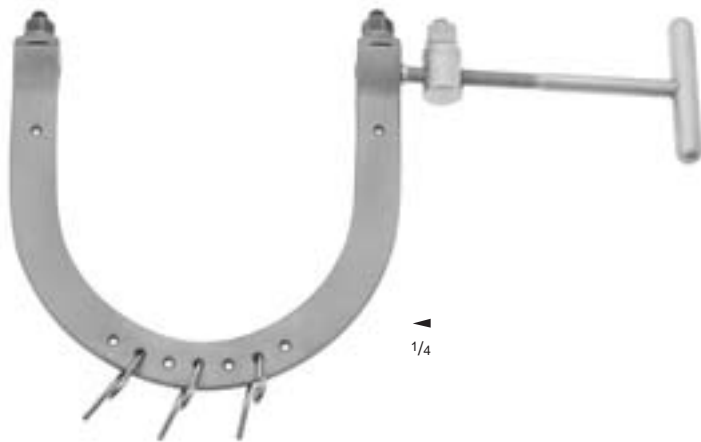

48-0645

Spannschlüssel mit Klemmbacke, zum Spannen des Drahtes

Wire tightener, with clamping jaws
Tensor de alambres
Tendeur de broches avec mors clampants
Strumento tenditore con morso a presa

Anwendung
Application
Aplicación
Application
Applicazione

KIRSCHNER

| | Weite Width Anchura interior Largeur ouverte Larghezza interna | Tiefe Depth Profundidad Profondité Profondità | | | | | | |
|----------------|--|---|---------------------------|---------------|--------------|-----------------|------------------|--|
| 48-0636 | 95 mm, 3 ³ / ₄ " | 70 mm, 2 ³ / ₄ " | Arm und Ellenbogen | arm and elbow | braza y codo | bras et poignet | braccio e gomito | |
| 48-0635 | 95 mm, 3 ³ / ₄ " | 110 mm, 4 ³ / ₈ " | Fersenbein | calcaneus | calcáneo | calcaneum | calcagno | |
| 48-0634 | 105 mm, 4 ¹ / ₈ " | 100 mm, 4" | Knie | knee | rodilla | genou | ginococchio | |
| 48-0633 | 120 mm, 4 ³ / ₄ " | 120 mm, 4 ³ / ₄ " | Knie | knee | rodilla | genou | ginococchio | |
| 48-0632 | 135 mm, 5 ¹ / ₄ " | 130 mm, 5 ¹ / ₈ " | Knie | knee | rodilla | genou | ginococchio | |
| 48-0631 | 155 mm, 6" | 155 mm, 6" | Oberschenkel | femur | fémur | fémur | femore | |
| 48-0630 | 200 mm, 8" | 155 mm, 6" | Hüfte | hip | coxa | hanche | anca | |

Extensionsbügel mit 3 Zughaken, zur Verwendung mit KIRSCHNER Drähten bis ø 2,5 mm
Wire traction bows with 3 traction hooks, to be used with KIRSCHNER wires up to 2.5 mm diam.
Estribos para extensión con 3 ganchos de tracción, para agujas de KIRSCHNER hasta ø 2,5 mm
Etriers à extension avec 3 crochets de traction, pour broches KIRSCHNER ø 2,5 mm
Archi per trazione con 3 ganci di trazione, da impiegarsi con fili KIRSCHNER superiori a 2,5 mm di ø

48-0660

40 - 130 mm, 1¹/₂" - 5¹/₈" / 100 mm, 4"

Extensionsbügel mit 3 Zughaken, zur Verwendung mit KIRSCHNER Drähten bis ø 2 mm, verstellbar, kleines Modell

Wire traction bow with 3 traction hooks, to be used with KIRSCHNER wires up to 2 mm diam., adjustable, small size

Estribo para extensión con 3 ganchos de tracción, para agujas de KIRSCHNER hasta ø 2 mm, ajustable, modelo pequeño

Etrier à extension avec 3 crochets de traction, pour broches KIRSCHNER ø 2 mm, réglable, petit modèle

Archi per trazione con 3 ganci di trazione, da impiegarsi con fili KIRSCHNER superiori a 2 mm di ø, regolabile, misura piccola

48-0661

80 - 260 mm, 3¹/₈" - 10¹/₄" / 150 mm, 6"

Extensionsbügel mit 3 Zughaken, zur Verwendung mit KIRSCHNER Drähten bis ø 2,5 mm, verstellbar, großes Modell

Wire traction bow with 3 traction hooks, to be used with KIRSCHNER wires up to 2.5 mm diam., adjustable, large size

Estribo para extensión con 3 ganchos de tracción, para agujas de KIRSCHNER hasta ø 2,5 mm, ajustable, modelo grande

Etrier à extension avec 3 crochets de traction, pour broches KIRSCHNER ø 2,5 mm, réglable, grand modèle

Archi per trazione con 3 ganci di trazione, da impiegarsi con fili KIRSCHNER superiori a 2,5 mm di ø, regolabile, misura grande

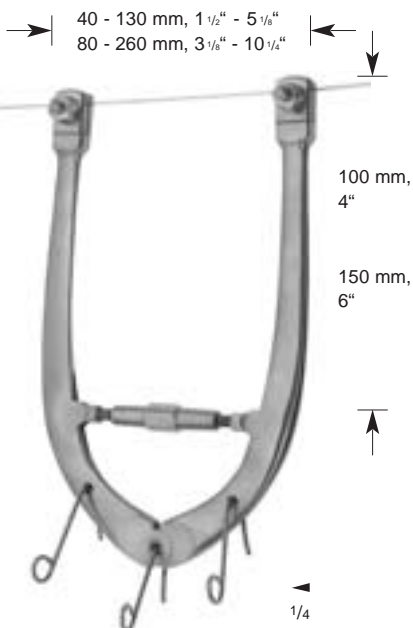

Extensionsbügel

Wire Traction Bows

Estribos para extensión

Etriers à extension

Archi per estensione

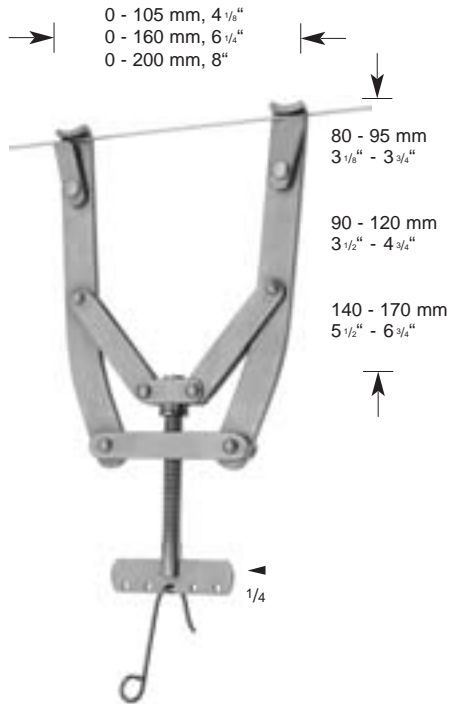

KIRSCHNER

48-0666

0 - 105 mm, 4 1/8" / 80 - 95 mm, 3 1/8" - 3 3/4"

Extensionsbügel mit 1 Zughaken, zur Verwendung mit KIRSCHNER Drähten bis ø 1,6 mm, verstellbar, selbsthemmend

Wire traction bow with 1 traction hook, to be used with KIRSCHNER wires up to 1.6 mm diam., adjustable, holds wire securely

Estribo para extensión con 1 gancho de tracción, para agujas de KIRSCHNER hasta ø 1,6 mm, ajustable, sujeto seguro de la aguja

Etrier à extension avec 1 crochet de traction, pour broches KIRSCHNER ø 1,6, réglable, avec blocage des broches

Archi per trazione con 1 ganci di trazione, da impiegarsi con fili KIRSCHNER superiori a 1,6 mm di ø, regolabile, fili in sicurezza

KIRSCHNER

48-0665

0 - 160 mm, 6 1/4" / 90 - 120 mm, 3 1/2" - 4 3/4"

Extensionsbügel mit 1 Zughaken, zur Verwendung mit KIRSCHNER Drähten bis ø 2,0 mm, verstellbar, selbsthemmend

Wire traction bow with 1 traction hook, to be used with KIRSCHNER wires up to 2.0 mm diam., adjustable, holds wire securely

Estribo para extensión con 1 gancho de tracción, para agujas de KIRSCHNER hasta ø 2,0 mm, ajustable, sujeto seguro de la aguja

Etrier à extension avec 1 crochet de traction, pour broches KIRSCHNER ø 2,0, réglable, avec blocage des broches

Archi per trazione con 1 ganci di trazione, da impiegarsi con fili KIRSCHNER superiori a 2,0 mm di ø, regolabile, fili in sicurezza

KIRSCHNER

▶ 48-0667

0 - 200 mm, 8" / 140 - 170 mm, 5 1/2" - 6 3/4"

Extensionsbügel mit 1 Zughaken, zur Verwendung mit KIRSCHNER Drähten bis ø 2,5 mm, verstellbar, selbsthemmend

Wire traction bow with 1 traction hooks, to be used with KIRSCHNER wires up to 2.5 mm diam., adjustable, holds wire securely

Estribo para extensión con 1 gancho de tracción, para agujas de KIRSCHNER hasta ø 2,5 mm, ajustable, sujeto seguro de la aguja

Etrier à extension avec 1 crochet de traction, pour broches KIRSCHNER ø 2,5, réglable, avec blocage des broches

Archi per trazione con 1 ganci di trazione, da impiegarsi con fili KIRSCHNER superiori a 2,5 mm di ø, regolabile, fili in sicurezza



48-0644

Spannschlüssel für Extensionsbügel
48-0630 - 48-0661

Wrench for wire traction bows 48-0630 - 48-0661

Llave de tuercas para estribo de extensión

Clef plate pour étrier à extension 48-0630 - 48-0661

Chiave per archi per trazione 48-0630 - 48-0661



48-0640

Zughaken, kleines Modell

Traction hook, small size

Gancho de tracción, modelo pequeño

Crochet de traction, petit modèle

Ganci di trazione, misura piccola



48-0641

Zughaken, großes Modell

Traction hook, large size

Gancho de tracción, modelo grande

Crochet de traction, grand modèle

Ganci di trazione, misura grande



48-0674

Begrenzungsplatte mit Schlitz

Fixation disc, slotted

Disco fijador con una muesca

Disque de fixation avec fente

Disco di fissaggio, scanalato



48-0675

Fixierscheiben (Begrenzungsplatten), Paar

Fixation discs, pair

Discos fijadores, par

Disques de fixation paire

Dischi di fissaggio, paio



48-0676

Schraubenzieher für Fixierscheiben

Screw driver, for fixation discs

Destornillador para discos fijadores

Vis pour fixation des disques

Vite guida, per dischi di fissaggio



Cerclage-Instrumente

Cerclage Instruments

Instrumentos para cerclaje

Instrumentos pour cerclage

Strumenti per cerchiaggio



1/2

- 48-0902 ø 0,2 mm
- 48-0903 ø 0,3 mm
- 48-0904 ø 0,4 mm
- 48-0905 ø 0,5 mm
- 48-0906 ø 0,6 mm
- 48-0907 ø 0,7 mm
- 48-0908 ø 0,8 mm
- 48-0909 ø 0,9 mm
- ▶ 48-0910 ø 1,0 mm
- 48-0912 ø 1,2 mm
- 48-0915 ø 1,5 mm

Cerclage-Drähte, weich,
in Ringen zu 10 m

Bone wires, soft, in
coils of 10 m

Hilos de cerclaje, blandos,
en rollos de 10 m

Fil pour cerclage, malléable,
en rouleau de 10 m

Filo per ossa, leggero,
in bobine da m. 10



LOUTE

48-0920

21,5 cm, 8 1/2"

Drahtspanner mit an der Spitze eingebauter
beweglicher Drahtspannbüchse für Cerclage-
Drähte bis ø 1 mm

Wire tightener, with movable tip, for wires up to
1.0 mm diam.

Tensor cierra-hilo con manguito movible en la
punta, para hilos de cerclaje hasta ø 1 mm

Serre-fil avec manche mobile intégré à la pointe
pour fil de cerclage jusqu'à ø 1 mm

Tenditore serra filo con manico mobile sulla
punta, per fili di cerchiaggio da 1 mm. di ø



1/3



1/1

▶ **48-0926**
27,5 cm, 10 3/4"



1/1

48-0927
28,5 cm, 11 1/4"



1/1

48-0928
30,5 cm, 12"

Drahtumführungsnadeln • Wire guides • Agujas pasa-hilos • Aiguilles passe-fils • Guida cavo

DEMEL
48-0926
- 48-0928

Drahtumführungsadeln

Wire Guides

Agujas pasa-hilos

Aiguilles passe-fils

Aghi passafili



hohl, spitz
hollow, sharp
hueco, agudo
creux, pointu
cavo, acuto

▶ **48-0931**
24 cm, 9 1/2"



48-0931
- **48-0932**



hohl, spitz
hollow, sharp
hueco, agudo
creux, pointu
cavo, acuto

48-0932
27 cm, 10 3/4"



48-0933
22,5 cm, 9"



hohl, spitz
hollow, sharp
hueco, agudo
creux, pointu
cavo, acuto



TITE GRIP® Drahtspannzangen mit Hartmetalleinlagen
TITE GRIP® Wire Twisting Forceps with tungsten carbide inserts
TITE GRIP® Pinzas cierra-hilos con bocas de carburo tungsteno
TITE GRIP® Pincers serre-fils avec mors en tungstène
TITE GRIP® Pinze gira cavo con morsi in carburo di tungsteno



08-0294
15 cm, 6"



08-0296
15 cm, 6"



CORWIN-HEGAR
08-0297
16 cm, 6 1/4"



08-0298
18 cm, 7"



08-0299
18,5 cm, 7 1/4"



LINDORF
48-0922
20 cm, 8"

Drahtfaßzangen

Wire Holding Forceps

Pinzas para extraer alambres

Pinces tire-broches

Pinze porta cavo



48-1484
- 48-1488

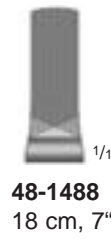
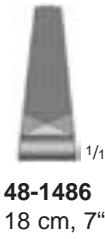

mit Hartmetalleinlagen
with tungsten carbide inserts
con bocas de carburo tungsteno
avec mors en tungstène
con inserti in carburo di tungsteno



Parallelschluß
Parallel action
Acción paralela
Action parallèle
Azione parallela



48-0484
- 48-0486

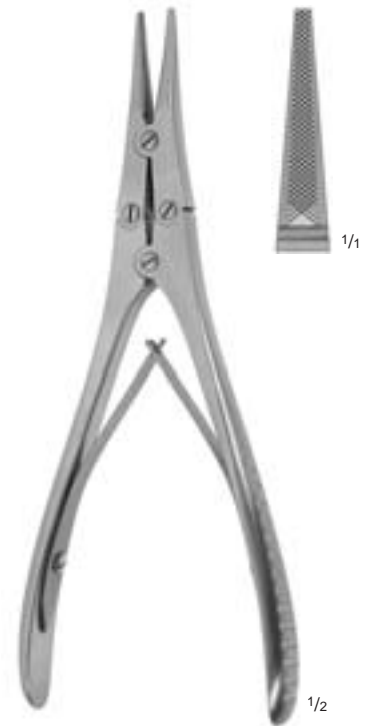
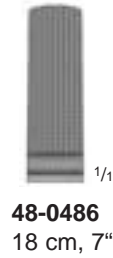
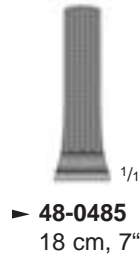
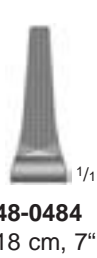

48-0487
19 cm, 7 1/2"



Drahtfaßzangen

Wire Holding Forceps

Pinzas para extraer alambres

Pinces tire-broches

Pinze porta cavo

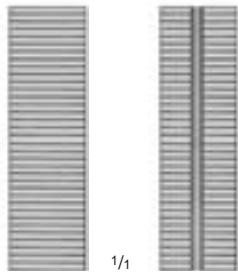

48-0491
17 cm, 6³/₄"



48-0492
18 cm, 7"



48-0493
16 cm, 6¹/₄"

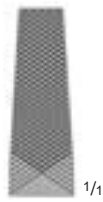

48-0494
17 cm, 6³/₄"



48-0495
17 cm, 6³/₄"



48-0496
19 cm, 7¹/₂"

Drahtscheren

Wire Cutting Scissors
Cizallas corta-alambres
Pincès coupe-fils
Forbici taglia cavo

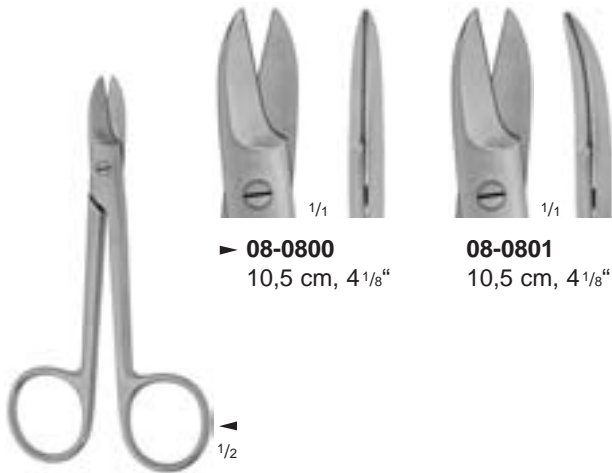

► **08-0800**
10,5 cm, 4 1/8"

08-0801
10,5 cm, 4 1/8"

BEEBEE
08-0800
- 08-0801

für weichen Draht bis \emptyset
for soft wire up to diam.
para blandos hasta un diam. de
pour couper les fils moux jusqu'à \emptyset
per cavi leggeri con \emptyset superiore a

0,4 mm

für harten Draht bis \emptyset
for hard wire up to diam.
para duros hasta un diam. de
pour couper les fils durs jusqu'à \emptyset
per cavi duri con \emptyset superiore a

0,3 mm

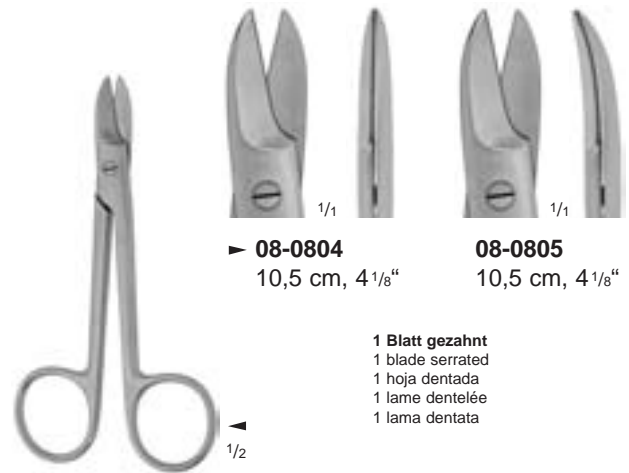

► **08-0804**
10,5 cm, 4 1/8"

08-0805
10,5 cm, 4 1/8"

BEEBEE
08-0804
- 08-0805

für weichen Draht bis \emptyset
for soft wire up to diam.
para blandos hasta un diam. de
pour couper les fils moux jusqu'à \emptyset
per cavi leggeri con \emptyset superiore a

0,4 mm

für harten Draht bis \emptyset
for hard wire up to diam.
para duros hasta un diam. de
pour couper les fils durs jusqu'à \emptyset
per cavi duri con \emptyset superiore a

0,3 mm

1 Blatt gezahnt
1 blade serrated
1 hoja dentada
1 lame dentelée
1 lama dentata



1 Blatt gezahnt
1 blade serrated
1 hoja dentada
1 lame dentelée
1 lama dentata

UNIVERSAL
08-0810
12 cm, 4 3/4"

für weichen Draht bis \emptyset
for soft wire up to diam.
para blandos hasta un diam. de
pour couper les fils moux jusqu'à \emptyset
per cavi leggeri con \emptyset superiore a

1,2 mm

für harten Draht bis \emptyset
for hard wire up to diam.
para duros hasta un diam. de
pour couper les fils durs jusqu'à \emptyset
per cavi duri con \emptyset superiore a

0,8 mm



DURACUT®

mit Hartmetallschneiden, 1 Blatt gezahnt
with tungsten carbide edges, 1 blade serrated
con filos de carburo tungsteno, 1 hoja dentada
avec mors tungstène, 1 lame dentelée
con inserti in carburo di tungsteno, 1 lama dentata

UNIVERSAL
05-1810
12 cm, 4 3/4"

für weichen Draht bis \emptyset
for soft wire up to diam.
para blandos hasta un diam. de
pour couper les fils moux jusqu'à \emptyset
per cavi leggeri con \emptyset superiore a

1,2 mm

für harten Draht bis \emptyset
for hard wire up to diam.
para duros hasta un diam. de
pour couper les fils durs jusqu'à \emptyset
per cavi duri con \emptyset superiore a

0,8 mm



Drahtkneifzangen
 Wire Cutting Pliers
 Alicates corta-alambres
 Pincers coupe fils
 Tenaglie tagliafilii



48-0470
 14,5 cm, 5³/₄"
Drahtbiege- und Schneidezange

Wire bending and cutting plier
 Alicate corta y cierra-alambre
 Pince à torsader et couper les fils
 Tenaglie curva/taglia fili

1,5 mm

48-0471
 16 cm, 6¹/₄"
Drahtbiege- und Schneidezange

Wire bending and cutting plier
 Alicate corta y cierra-alambre
 Pince à torsader et couper les fils
 Tenaglie curva/taglia fili

1,5 mm

08-0890
 15,5 cm, 6"

Drahtkneifzange
 Wire cutting plier
 Alicate corta-alambre
 Pince à couper le fil
 Tenaglie tagliafilii

2,0 mm

08-0888
 16 cm, 6¹/₄"

Drahtkneifzange
 Wire cutting plier
 Alicate corta-alambre
 Pince à couper le fil
 Tenaglie tagliafilii

2,0 mm

für weichen Draht bis ø
 for soft wire up to diam.
 para blandos hasta un diam de.
 pour couper les fils doux jusqu'à ø
 per cavi leggeri con ø superiore a

für harten Draht bis ø
 for hard wire up to diam.
 para duros hasta un diam. de
 pour couper les fils durs jusqu'à ø
 per cavi duri con ø superiore a

1,0 mm

1,0 mm

1,5 mm

1,5 mm

DURACUT® Drahtkneifzangen
 DURACUT® Wire Cutters
 DURACUT® Alicates corta-alambres
 DURACUT® Pincès à couper le fil
 DURACUT® Tenaglie tagliafili



1/2



1/2



1/2



1/2



1/2

48-1497
12,5 cm, 5"

Drahtkneifzange mit Hartmetallschneiden

Wire cutter with tungsten carbide edges

Alicate corta-alambre con filos de carburo tungsteno

Pincès à couper le fil, avec mors tungstène

Tenaglie tagliafili, con inserti in carburo di tungsteno

0,6 mm

48-1498
18,5 cm, 7 1/4"

Drahtkneifzange mit Hartmetallschneiden

Wire cutter with tungsten carbide edges

Alicate corta-alambre con filos de carburo tungsteno

Pincès à couper le fil, avec mors tungstène

Tenaglie tagliafili, con inserti in carburo di tungsteno

2,0 mm

48-1491
17,5 cm, 7"

Drahtkneifzange mit Hartmetallschneiden

Wire cutter with tungsten carbide edges

Alicate corta-alambre con filos de carburo tungsteno

Pincès à couper le fil, avec mors tungstène

Tenaglie tagliafili, con inserti in carburo di tungsteno

2,0 mm

48-1495
22 cm, 8 3/4"

Drahtkneifzange mit Hartmetallschneiden

Wire cutter with tungsten carbide edges

Alicate corta-alambre con filos de carburo tungsteno

Pincès à couper le fil, avec mors tungstène

Tenaglie tagliafili, con inserti in carburo di tungsteno

2,8 mm

48-1496
23,5 cm, 9 1/4"

Drahtkneifzange mit Hartmetallschneiden

Wire cutter with tungsten carbide edges

Alicate corta-alambre con filos de carburo tungsteno

Pincès à couper le fil, avec mors tungstène

Tenaglie tagliafili, con inserti in carburo di tungsteno

3,0 mm

0,4 mm

1,7 mm

1,7 mm

2,5 mm

2,7 mm



Kopf- und Seitenschneider
 Front and Lateral Cutter
 Alicates de corte frontal y lateral
 Pince à couper le fil
 Cesoia con taglio frontale e laterale

Bolzenschneider
 Cutters
 Alicates corta-alambres
 Pinces
 Cesoie



48-1499
 18 cm, 7"

Kopf- und Seitenschneider mit Hartmetallschneiden, für weichen Draht bis \varnothing 2,0 mm und für harten Draht bis \varnothing 1,5 mm

Front and lateral cutter with tungsten carbide edges, for soft wire up to diam. 2.0 mm and for hard wire up to diam. 1.5 mm

Alicates de corte frontal y lateral con filos de carburo tungsteno para alambres blandos hasta un diam. de 2,0 mm y para alambres duros hasta un de 1,5 mm diam.

Pince à couper le fil, frontale et latérale, pour fil mou jusqu'à 2,0 mm \varnothing et pour fil dur jusqu'à 1,5 mm \varnothing

Cesoia con taglio frontale e laterale con inserti in carburo di tungsteno, per cavi morbidi con \varnothing superiore a 2 mm. e cavi duri con \varnothing inferiore a 1,5 mm



► **48-0498** 48 cm, 18³/₄"
48-0499 54 cm, 21¹/₄"

Bolzenschneider zum Abwickeln von Drähten, Schrauben und Nägeln bis \varnothing 6 mm

Cutters for cutting of wires, screws and pins up to diam. 6 mm

Alicates corta-alambres, tornillos y clavos hasta \varnothing 6 mm

Pinces à couper les fils, pivots et clous jusqu'à 6 mm \varnothing

Cesoia per cavi, viti e perni, con \varnothing superiore a 6 mm

Knochenbiopsie-Instrumente

Bone Biopsy Instruments

Instrumentos para biopsia ósea

Instrumentes pour biopsie osseuse

Strumenti per biopsia ossea



CHAMPY

► 48-0950

ø 5 mm

Biopsie-Instrument zur Entnahme von Knochenspänen aus dem Beckenkamm komplett, bestehend aus:

48-0951 1 Trokarhülse

48-0952 1 Punktionstrephine

48-0953 1 Stumpfer Mandrin

Bone biopsy trephine for iliac crest, complete, consisting of:

48-0951 1 Trocar cannula

48-0952 1 Biopsy trephine

48-0953 1 Blunt obturator

Trépano para la cresta iliaca, completo, compuesto de:

48-0951 1 Cánula de trocar

48-0952 1 Trépano de biopsia

48-0953 1 Mandrin romo

Instrument à biopsie pour prélever particules de l'os iliaque

complet, composé de:

48-0951 1 Canule de trocar

48-0952 1 Tréphine de biopsie

48-0953 1 Obturateur

Strumento biopsia per trucioli dell'iliaco, completa, composta da:

48-0951 1 Camicia per tre quarti

48-0952 1 Trapano per biopsia

48-0953 1 Otturatore

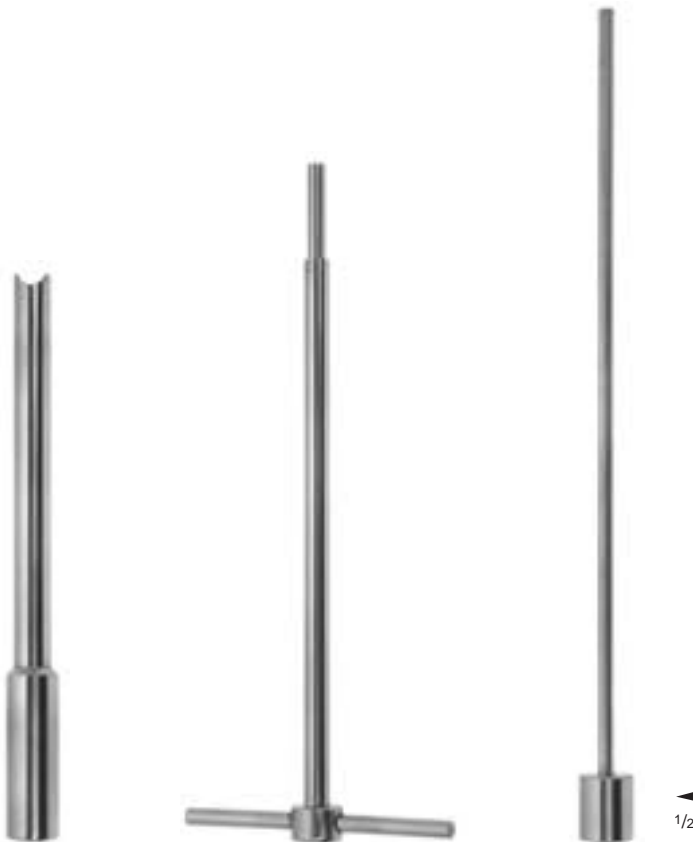

CHAMPY

48-0955

ø 8 mm

Biopsie-Instrument zur Entnahme von Knochenspänen aus dem Beckenkamm komplett, bestehend aus:

48-0956 1 Trokarhülse

48-0957 1 Punktionstrephine

48-0958 1 Stumpfer Mandrin

Bone biopsy trephine for iliac crest, complete, consisting of:

48-0956 1 Trocar cannula

48-0957 1 Biopsy trephine

48-0958 1 Blunt obturator

Trépano para la cresta iliaca, completo, compuesto de:

48-0956 1 Cánula de trocar

48-0957 1 Trépano de biopsia

48-0958 1 Mandrin romo

Instrument à biopsie pour prélever

particules de l'os iliaque

complet, composé de:

48-0956 1 Canule de trocar

48-0957 1 Tréphine de biopsie

48-0958 1 Obturateur

Strumento biopsia per trucioli

dell'iliaco, completa, composta da:

48-0956 1 Camicia per tre quarti

48-0957 1 Trapano per biopsia

48-0958 1 Otturatore



Notizen

Notes

Notas

Notes

Note

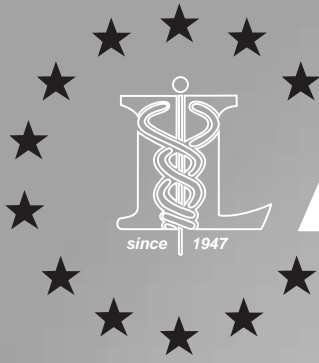

LAWNTON

Medizintechnik



Verband und Gips
Dressing
Vendajes
Pansements, Appareils plâtrés
Bendaggi, Gessature



Verbandscheren
Bandage Scissors
Tijeras para vendajes
Ciseaux à pansements
Forbici per bendaggi



SMITH
05-0802
- 05-0804



► 05-0802
18 cm, 7"



05-0804
20 cm, 8"

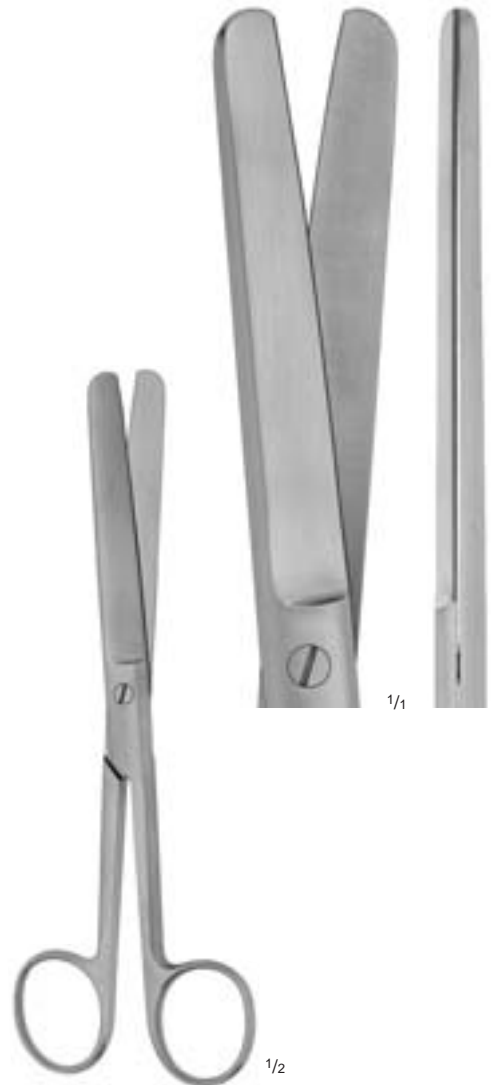

LANGE
05-0806
19 cm, 7 1/2"

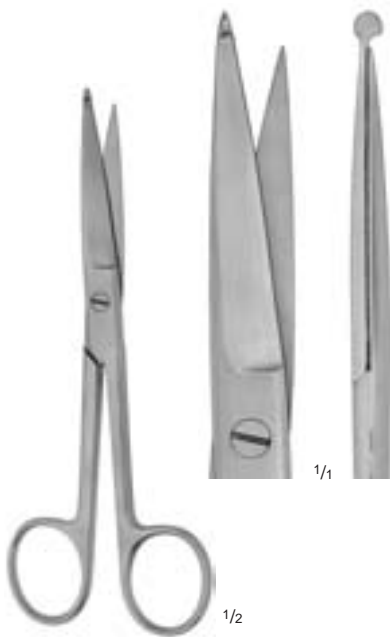

KNOWLES
 05-0895
 14,5 cm, 5³/₄"

für Fingerverbände
 for finger bandages
 para vendajes de dedos
 pour bandages des doigts
 per bendaggi delle dita



LISTER modif.
 05-0835
 14,5 cm, 5³/₄"

1 Blatt gezahnt
 1 blade serrated
 1 hoja dentada
 1 lame dentelée
 1 lama dentata

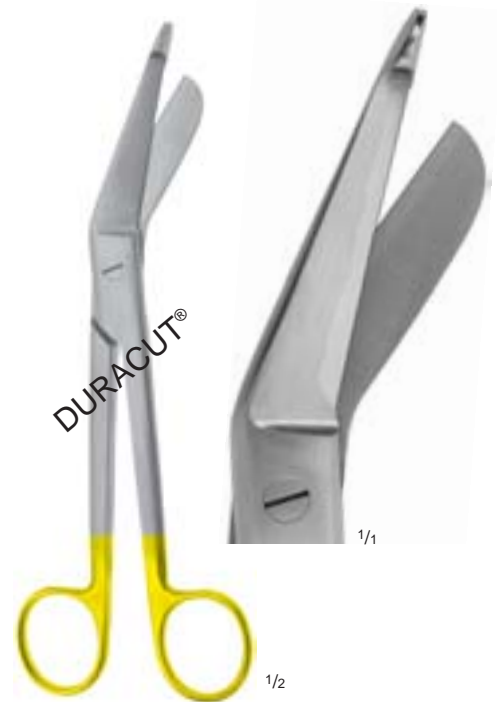

LISTER
 05-1850
 18 cm, 7"

mit Hartmetallschneiden
 with tungsten carbide edges
 con filos de carburo tungsteno
 avec des lames en tungstène
 con lame in carburo di tungsteno



LISTER
 05-0820
 - 05-0860



05-0820
 11,5 cm, 4¹/₂"



▶ 05-0830
 14,5 cm, 5³/₄"



05-0850
 18 cm, 7"



05-0860
 20 cm, 8"



Verband- und Kleiderstoffscheren
Bandage and Cloth Scissors
Tijeras para vendajes y tela
Cisailles à pansements et étoffes d'habillement
Cesoie per bendaggi e vestiti



LISTER
04-5810
14,5 cm, 5³/₄"

Universal Verband- und Kleiderstoffschere aus rostfreiem, säurebeständigem Stahl, mit 1 gezahnten Blatt und Kunststoffgriffen, bis 134°C im Autoklaven sterilisierbar.

Universal bandage and cloth scissors, made of acid-proof stainless steel, with 1 serrated blade and plastic handles, autoclavable up to 134°C.

Tijera universal para vendajes y tela, acero inoxidable y resistente a los ácidos, con 1 hoja dentada y mangos de plástico, esterilizable en autoclave hasta 134°C.

Ciseaux universels pour étoffes en acier inox, avec 1 lame crantée et anneaux en plastique, autoclavables à 134°C.

Cesoie per bendaggi e vestiti, in acciaio inox resistente agli acidi con 1 lama dentata, manico in plastica, sterilizzabile in autoclave fino 134°C.



04-5800
18 cm, 7"

Universal Verband- und Kleiderstoffschere aus rostfreiem, säurebeständigem Stahl, mit 1 gezahnten Blatt und Kunststoffgriffen, bis 134°C im Autoklaven sterilisierbar.

Universal bandage and cloth scissors, made of acid-proof stainless steel, with 1 serrated blade and plastic handles, autoclavable up to 134°C.

Tijera universal para vendajes y tela, acero inoxidable y resistente a los ácidos, con 1 hoja dentada y mangos de plástico, esterilizable en autoclave hasta 134°C.

Ciseaux universels pour étoffes en acier inox, avec 1 lame crantée et anneaux en plastique, autoclavables à 134°C.

Cesoie per bendaggi e vestiti, in acciaio inox resistente agli acidi con 1 lama dentata, manico in plastica, sterilizzabile in autoclave fino 134°C.



► 05-0950
20 cm, 8"

05-0952
23,5 cm, 9 1/4"

ESMARCH
05-0950
- 05-0952



42-0110
21 cm, 8 1/4"



BERGMANN
05-0864
23 cm, 9"



SEUTIN
42-0115
23 cm, 9"



Gipsscheren
Plaster-of-Paris Shears
Cizallas para escayolas
Cisailles pour appareils plâtrés
Cesoie per gessi



BRUNS
05-1970
24 cm, 9 1/2"

mit Hartmetallschneiden
with tungsten carbide edges
con filos de carburo tungsteno
avec des lames en tungstène
con lame in carburo di tungsteno



BRUNS
05-0970
24 cm, 9 1/2"



BRUNS
05-0975
24 cm, 9 1/2"

1 Blatt gezahnt
1 blade serrated
1 hoja dentada
1 lame dentelée
1 lama dentata

Gipsscheren
Plaster-of-Paris Shears
Cizallas para escayolas
Cisailles pour appareils plâtrés
Cesoie per gessi



1/1



1/1



1/2

STILLE-MINI
42-0118
19,5 cm, 7³/₄"

für kleine Gipsverbände
for small plaster dressings
para escayolas pequeñas
pour petits pansements plâtrés
per piccole gessature



1/2

STILLE
42-0120
24,5 cm, 9³/₄"



Gipsscheren
Plaster-of-Paris Shears
Cizallas para escayolas
Cisailles pour appareils plâtrés
Cesoie per gessi



42-0145
23 cm, 9"



▶ 42-0147
27 cm, 10³/₄"



42-0150
37,5 cm, 14³/₄"



STILLE
42-0145
- 42-0150

Klinge mit verstärktem Rücken
blade with reinforced back
hoja con espalda reforzada
lame avec dos renforcé
lama con dorso rinforzato

◀
1/2

Gipsmesser
Plaster Knives
Cuchillos para escayolas
Couteaux pour appareils plâtrés
Coltelli per gessi

Gipssäge
Plaster Saw
Sierra para escayolas
Scie pour appareils plâtrés
Seghe per gessi



ESMARCH
42-0245
18 cm, 7"

Gipsmesser
Plaster knife
Cuchillo para escayolas
Couteaux pour appareils plâtrés
Coltello per gessi



REINER
42-0240
18 cm, 7"

Gipsmesser
Plaster knife
Cuchillo para escayolas
Couteaux pour appareils plâtrés
Coltello per gessi



HOPKINS
42-0232
20 cm, 8"

Gipsmesser mit
Ebenholzheft
Plaster knife with
ebony handle
Cuchillo para escayolas
con mango de ébano
Couteaux pour appareils
plâtrés avec manche ébonite
Coltello per gessi con
manico in ebano



HOPKINS
42-0234
20,5 cm, 8"

Gipsmesser mit
Ebenholzheft
Plaster knife with
ebony handle
Cuchillo para escayolas
con mango de ébano
Couteaux pour appareils
plâtrés avec manche ébonite
Coltello per gessi con
manico in ebano



ENGEL
42-0210
15 cm, 6"

Gipssäge
Plaster saw
Sierra para escayolas
Scie pour appareils plâtrés
Seghe per apparecchi gessati



Oscillierende Gipssäge
Oscillating Plaster Saw
Sierra oscilante para escayolas
Scie oscillante à plâtre
Sega oscillante



42-0351 110 V / 50 Hz
42-0350 220 V / 50 Hz

Die oscillierende Gipssäge wird mit 2 rostfreien Sägeblättern \varnothing 50 + 65 mm (42-0356 + 42-0357) sowie 2 Schraubenschlüssel (42-0355), zum Auswechseln der Sägeblätter geliefert. Als Sonderzubehör für Hartverbände (z. B. Glasfaser etc.) sind 2 spezialgehärtete Sägeblätter \varnothing 50 + 65 mm (42-0358 + 42-0359) lieferbar. Es sollten keine ungepolsterten Gipsverbände aufgeschnitten werden, da durch Mitschwingen der angeklebten Haut am Gips Verletzungsgefahr für die Haut besteht. Für die Normalbenutzung sollte das kleine Sägeblatt mit \varnothing 50 mm verwendet werden. Das große Sägeblatt mit \varnothing 65 mm nur in Ausnahmefällen (z. B. bei dickem Gips etc.) verwenden. Das Gerät ist wartungsfrei, sollte jedoch alle 1 bis 2 Jahre vom Hersteller überprüft werden. Die Gipssäge ist mit einem Sicherheitsschutz-Schalter ausgerüstet. Dieser gewährleistet eine Überbelastung des Motors. Sollte durch Überbelastung die Gipssäge aussetzen, kann diese innerhalb weniger Minuten mittels eines Spezial-Einschalt-Knopfes wieder in Betrieb genommen werden. Dieser Einschalt-Knopf befindet sich unterhalb der Motor-Kabelzuführung. Um eine zu hohe Erwärmung zu vermeiden, empfehlen wir stumpfe und abgenutzte Sägeblätter auszuwechseln. Zur Auswechslung abgenutzter Sägeblätter sollten ausschließlich die mitgelieferten Schraubenschlüssel verwendet werden. Sie vermeiden dadurch ein Überdrehen des Extenters. In regelmäßigen Abständen sollte das rostfreie Kühl-Draht-Gitter gereinigt werden. In explosionsgefährdeten Bereichen darf die Gipssäge nicht verwendet werden. **Technische Daten:** Leistungsaufnahme 90 Watt • Schutzklasse II nach VDE 0740 • Schutzisoliert • Funkenstört • Motorschutzschalter • Gewicht 1500 g.

The oscillating plaster-saw is supplied with 2 stainless steel sawblades with diameters of 50 + 65 mm (42-0356 + 42-0357) plus 2 spanners (42-0355) to exchange the sawblades. As a special requisite for hard bandage (e. g. glass-fibre etc.) 2 specially hardened sawblades diameters 50 + 65 mm (42-0358 + 42-0359) are available. Normally, the small sawblade with diameter 50 mm is used. The large sawblade with diameter 65 mm is used in exceptional cases (e.g. by thick plaster etc.). The unit is maintenance-free, but should however be checked every 1 to 2 years by the manufacturers. The plaster-saw is equipped with a safety-protective switch. This guarantees the motor against overloading. Should the plaster-saw become unfunctional due to overloading the unit can be put into use again within minutes by use of a special switch-on button. The switch-on button is located underneath the motor-cable inlet. To prevent excessive heating we recommend rechanging of blunt and used sawblades. Replacement of used sawblades should only be undertaken with the use of the supplied spanners. This will prevent over-winding. The stainless steel cool-element-grid should be cleaned at regular intervals. The plaster-saw should not be used in explosive danger areas. **Technical Data:** Input 90 watt • Protection class II acc. to VDE 0740 • Protective insulated • Anti-signal interference • Motor-safety switch • Weight 1500 g.

La sierra oscilatoria para escayolas se entrega con dos hojas \varnothing 50 + 65 mm (42-0356 + 42-0357) para serrar y con dos llaves de tuerca especiales (42-0355) para cambiar las hojas de sierra. Para serrar objetos o escayolas de gran resistencia, como fibra de vidrio, disponemos de dos hojas de sierra especialmente templadas \varnothing 50 + 65 mm (42-0358 + 42-0359). No se debe nunca serrar ninguna escayola sin haber sido antes debidamente protegida, pues por la vibración, podrían ocasionarse heridas en la piel pegada a la escayola. Para el uso corriente se emplea la hoja de sierra de \varnothing 50 mm. La hoja de \varnothing 65 mm se usa en casos excepcionales, p.e. cuando la escayola es demasiado gruesa etc.. La sierra oscilante, no exige ningún cuidado especial; debe ser, sin embargo, controlada por el constructor cada año o dos. Esta equipada con un interruptor de seguridad. Dicho interruptor evita el recalentamiento excesivo del motor. En el caso que, por recalentamiento excesivo, se parase el motor, éste podría ser puesto nuevamente en función dentro de pocos minutos, articulando un interruptor especial que se encuentra junto a la salida del cable del motor. Para evitar que se recaliente, se aconseja cambiar las hojas de sierra que no estén en buen estado. Para cambiar las hojas de sierra usadas, debe emplearse únicamente la llave especial que acompaña la sierra. De vez en cuando debe limpiarse la rejilla inoxidable de refrigeración. En lugares, en los cuales exista peligro de explosión, no debe ser empleada dicha sierra. **Datos técnicos:** Potencia de desarrollo 90 W. • clase de protección II según VDE 0740 • protegida con capa aislante • protegida contra interferencias • interruptor protector para el motor • peso 1500 g.

La scie à plâtre oscillante est livrée avec deux lames inoxydables de 50 et 65 mm de \varnothing (42-0356 et 42-0357) ainsi que deux clés à écrous pour changer les lames. En accessoire spécial pour plâtres durs (par ex. fibres de verre etc.), 2 lames de scie en acier trempé spécial de 50 et 65 mm de \varnothing (42-0358 et 42-0359) sont disponibles. Ne pas couper de plâtres non rembourrés; en effet, la couverture de la peau collée au plâtre entraîne un risque de blessure de la peau. Pour l'emploi normal, utiliser la petite lame de scie de 50 mm de \varnothing . N'utiliser la grande lame de scie de 65 mm de \varnothing que dans les cas exceptionnels (par ex. pour des plâtres épais etc.). L'appareil ne demande pas d'entretien, il doit cependant être vérifié par le fabricant tous les 1 à 2 ans. La scie à plâtre est équipée d'un disjoncteur de sécurité. Ce dernier protège le moteur contre la surcharge. Si la scie disjoncte en raison d'une surcharge, elle peut être remise en service au bout de quelques minutes à l'aide d'un bouton spécial de mise en circuit. Ce bouton de mise en circuit se trouve au-dessous du passage du câble du moteur. Afin d'éviter un trop fort échauffement, nous conseillons de remplacer les lames de scie émoussées et usagées. Pour changer les lames de scie usagées, utiliser exclusivement les clés à écrous livrées avec la scie. Vous éviterez ainsi de fausser le dispositif de serrage. Nettoyer à intervalles réguliers la grille métallique inoxydable de refroidissement. Ne pas utiliser la scie à plâtre dans les zones de danger d'explosion. **Caractéristiques techniques:** puissance absorbée 90 Watt • Catégorie II de protection selon VDE 0740 • Double isolation • Antiparasitisme • Disjoncteur-protecteur • Poids 1500 g.

La sega oscillante è corredata con 2 lame in acciaio inox \varnothing 50 e 65 mm. (42-0356 e 42-0357) più 2 chiavi (42-0355) per il cambio delle lame. Quale speciale requisito per bendaggi duri (vetro, fibre, ecc.) sono disponibili 2 lame particolarmente indurite del \varnothing 50 e 65 mm. (42-0358 e 43-0359). Normalmente viene impiegata la lama piccola da 50 mm.. La lama grande da 65 mm. viene impiegata in casi eccezionali (gesso spesso, ecc.). L'unità non necessita di manutenzione ma deve essere controllata dalla casa madre ogni 1 o 2 anni. La sega oscillante è munita di interruttore di sicurezza di protezione. Questo protegge il motore dai sovraccarichi. Qualora la sega oscillante fosse inutilizzabile per sovraccarico, l'unità potrà essere rimessa in funzione in pochi minuti attraverso uno speciale bottone situato nella parte inferiore dell'avvolgimento interno. Per prevenire eccessivi surriscaldamenti raccomandiamo di sostituire la lama troppo usata. La sostituzione delle lame deve essere effettuata impiegando esclusivamente le chiavi in dotazione al fine di prevenire sovrappressioni. La griglia di raffreddamento in acciaio inox deve essere pulita ad intervalli regolari. La sega oscillante non deve essere impiegata in aree con pericoli di esplosione. **Dati tecnici:** potenza 90 Watt. • classe di protezione II secondo le norme VDE 0740 • isolamento di protezione • protezione contro le interferenze • interruttore di protezione sul motore • peso 1500 gr.



42-0356
ø 50 mm

Ersatz-Sägeblatt
Spare saw blade
Hoja de sierra, repuesto
Lame de rechange
Lama di ricambio



42-0357
ø 65 mm

Ersatz-Sägeblatt
Spare saw blade
Hoja de sierra, repuesto
Lame de rechange
Lama di ricambio



42-0358
ø 50 mm

Ersatz-Sägeblatt, spezialgehärtet, für Fiberglas- und andere Hartverbände

Spare saw blade, special hardness, for dressing of fiber glass

Hoja de sierra templada especial, para escayolas de fibra de vidrio y otras escayolas gruesas, repuesto

Lame de rechange, à acier trempé pour bandages en fibres de verre et autres bandages durs

Lama di ricambio a temprata speciale per bendaggi in fibre di vetro ed altri bendaggi duri



42-0359
ø 65 mm

Ersatz-Sägeblatt, spezialgehärtet, für Fiberglas- und andere Hartverbände

Spare saw blade, special hardness, for dressing of fiber glass

Hoja de sierra templada especial, para escayolas de fibra de vidrio y otras escayolas gruesas, repuesto

Lame de rechange, à acier trempé pour bandages en fibres de verre et autres bandages durs

Lama di ricambio a temprata speciale per bendaggi in fibre di vetro ed altri bendaggi duri



42-0355

Spannschlüssel
Spanners
Llaves de tuerca
Clés à vis
Chiavi



Gipsspreizer
Plaster Spreaders
Separadores para escayolas
Pincas écartantes à plâtre
Apri gesso

Gipsabreißzangen
Plaster Breakers
Pinzas para romper escayolas
Pincas écrasante pour plâtre
Rompi gesso



1/1



1/1



1/1



1/1

42-0302
17,5 cm, 7"

▶ 42-0300
26,5 cm, 10 1/2"



1/3

MOD. USA
42-0315
22,5 cm, 9"

Gipsspreizer
Plaster spreader
Separador para escayolas
Pince écartante à plâtre
Apri gesso



1/3

HENNIG
42-0320
27 cm, 10 3/4"

Gipsspreizer
Plaster spreader
Separador para escayolas
Pince écartante à plâtre
Apri gesso



1/3

WOLFF
42-0300
- 42-0302

Gipsabreißzangen
Plaster breakers
Pinza para romper escayolas
Pince écrasante pour plâtre
Rompi gesso



LAWNTON

Medizintechnik



Neurochirurgie und Laminektomie
Neurosurgery and Laminectomy
Neurocirugía y Laminectomía
Neurochirurgie et Laminectomie
Neurochirurgia e Laminectomia



Instrumente für Neurochirurgie und Laminektomie
Instruments for Neurosurgery and Laminectomy
Instrumentos para neurocirugía y laminectomía
Instruments pour neurochirurgie et laminectomie
Strumenti per neurochirurgia e laminectomia



Rasierklingen-Halter und -Brecher Seite 36
Razor Blade Holders and Breakers Page 36
Pinzas para sujetar y romper hojas de afeitarse Página 36
Pincettes pour saisir et casser les lames de rasoir Page 36
Pinze per afferrare e rompere le lamette di rasoio Pagina 36



Duramesser Seite 37
Dura Knives Page 37
Cuchillos para dura-madre Página 37
Couteaux pour dure-mère Page 37
Bisturi per dura-madre Pagina 37



Mikro-Federscheren, bajonettförmig Seite 66 - 67
Micro Spring Type Scissors, bayonet-shaped Page 66 - 67
Micro-Tijeras con mangos de resortes, forma en bayoneta Página 66 - 67
Micro ciseaux en forme de baïonnette avec manches à ressorts Page 66 - 67
Micro forbici con manici a molla, forma a baionetta Pagina 66 - 67



Scheren für Neurochirurgie Seite 100
Neurosurgical Scissors Page 100
Tijeras para neurocirugía Página 100
Ciseaux pour la neuro-chirurgie Page 100
Forbici per neurochirurgia Pagina 100



Mikro-Pinzetten, bajonettförmig Seite 125
Micro Forceps, bayonet-shaped Page 125
Micro-Pinzas, en forma bayoneta Página 125
Micro Pincas en forme de baïonnette Page 125
Micro Pinze con manici a baionetta Pagina 125



Tumor- und Gewebefäßpinzetten, bajonettförmig Seite 126 - 127
Tumor and Tissue Grasping Forceps, bayonet-shaped Page 126 - 127
Pinzas de agarre para tejido y tumor, en forma bayoneta Página 126 - 127
Pincas en forme de baïonnette pour saisir tumeurs et tissus Page 126 - 127
Pinze per afferrare tessuti e tumori, a baionetta Pagina 126 - 127

Instrumente für Neurochirurgie und Laminektomie
 Instruments for Neurosurgery and Laminectomy
 Instrumentos para neurocirugía y laminectomía
 Instruments pour neurochirurgie et laminectomie
 Strumenti per neurochirurgia e laminectomia



| | | |
|---|--------|-----------|
| Gefäßclips für temporären Gebrauch | Seite | 154 - 156 |
| Vessel Clips for temporary occlusion | Page | 154 - 156 |
| Clips vasculares para oclusión temporal | Página | 154 - 156 |
| Serre-Fines pour occlusion temporaire | Page | 154 - 156 |
| Pinze per occlusioni temporanee | Pagina | 154 - 156 |



| | | |
|----------------------|--------|-----------|
| Approximatoren | Seite | 157 - 159 |
| Approximators | Page | 157 - 159 |
| Aproximadores | Página | 157 - 159 |
| Approximateurs | Page | 157 - 159 |
| Aprossimatori | Pagina | 157 - 159 |



| | | |
|----------------------------------|--------|----------------|
| Durahäkchen | Seite | 212, 216 - 218 |
| Dura Retractors | Page | 212, 216 - 218 |
| Ganchos para dura-madre | Página | 212, 216 - 218 |
| Crochets pour la dura-mère | Page | 212, 216 - 218 |
| Uncini per dura-madre | Pagina | 212, 216 - 218 |



| | | |
|---------------------------------------|--------|-----------|
| Nerv- und Gefäßhäkchen | Seite | 213 - 215 |
| Nerve and Vessel Hooks | Page | 213 - 215 |
| Ganchos para nervios y vasos | Página | 213 - 215 |
| Crochets à nerfs et à vaisseaux | Page | 213 - 215 |
| Uncini per nervi e vasi | Pagina | 213 - 215 |



| | | |
|--|--------|-----|
| Explorations- und Koagulationshäkchen, isoliert | Seite | 215 |
| Exploration and Coagulation Hooks, insulated | Page | 215 |
| Ganchos para exploración y coagulación, aislados | Página | 215 |
| Crochets pour exploration et coagulation, isolés | Page | 215 |
| Uncini per esplorazione e coagulazione, isolati | Pagina | 215 |



| | | |
|-------------------------------------|--------|---------------------------|
| Laminektomie-Wundspreizer | Seite | 279 - 280, 284, 286 - 287 |
| Laminectomy Retractors | Page | 279 - 280, 284, 286 - 287 |
| Separadores para laminectomía | Página | 279 - 280, 284, 286 - 287 |
| Ecarteurs pour laminectomie | Page | 279 - 280, 284, 286 - 287 |
| Divaricatori per laminectomia | Pagina | 279 - 280, 284, 286 - 287 |





Instrumente für Neurochirurgie und Laminektomie
 Instruments for Neurosurgery and Laminectomy
 Instrumentos para neurocirugía y laminectomía
 Instruments pour neurochirurgie et laminectomie
 Strumenti per neurochirurgia e laminectomia



| | | |
|--|--------|----------------|
| Wundspreizer für die cervicale Wirbelsäule | Seite | 285, 290 - 293 |
| Retractors for cervical spine | Page | 285, 290 - 293 |
| Separadores para la columna cervical | Página | 285, 290 - 293 |
| Ecarteurs pour colonne cervicale | Page | 285, 290 - 293 |
| Divaricatori per colonna cervicale | Pagina | 285, 290 - 293 |



| | | |
|---|--------|-----------|
| Wundspreizer für die Wirbelsäule | Seite | 288 - 289 |
| Retractors for vertebral column | Page | 288 - 289 |
| Separadores para la columna vertebral | Página | 288 - 289 |
| Ecarteurs pour colonne vertebrale | Page | 288 - 289 |
| Divaricatori per colonna vertebrale | Pagina | 288 - 289 |



| | | |
|---|--------|-----|
| Wundspreizer für die lumbale Wirbelsäule | Seite | 294 |
| Retractors for lumbar vertebral column | Page | 294 |
| Separadores para la cirugía lumbar vertebral | Página | 294 |
| Ecarteurs pour chirurgie lombaire | Page | 294 |
| Divaricatori per colonna lombare e vertebrale | Pagina | 294 |



| | | |
|---|--------|-----|
| Spekula für lumbale Bandscheibenoperationen | Seite | 295 |
| Specula for lumbar vertebral operations | Page | 295 |
| Espéculos para la cirugía lumbar vertebral | Página | 295 |
| Spéculum pour chirurgie lombaire | Page | 295 |
| Speculo per interventi lombo-vertebrali | Pagina | 295 |



| | | |
|--|--------|-----|
| Wirbelkörperspreizer | Seite | 296 |
| Lamina Spreaders | Page | 296 |
| Separadores para cuerpos vertebrales | Página | 296 |
| Ecarteurs pour corps vertébraux | Page | 296 |
| Separatori per vertebre | Pagina | 296 |



| | | |
|--|--------|-----|
| Mikro-Nadelhalter, bajonettförmig | Seite | 362 |
| Micro Needle Holders, bayonet-shaped | Page | 362 |
| Micro-Porta-agujas, en forma bayoneta | Página | 362 |
| Micro porte-aiguilles en forme de baïonnette | Page | 362 |
| Micro porta-aghi con manici a baionetta | Pagina | 362 |

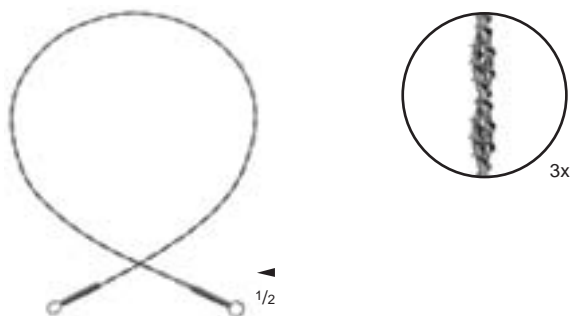

- OLIVECRONA (GIGLI)**
- ▶ 47-0360 25 cm, 10"
 - 47-0365 30 cm, 12"
 - 47-0367 40 cm, 16"
 - 47-0370 50 cm, 20"
 - 47-0371 60 cm, 24"
 - 47-0375 70 cm, 28"

Drahtsägen
 Wire saws
 Sierras de hilo
 Fils-scies
 Fili per sega

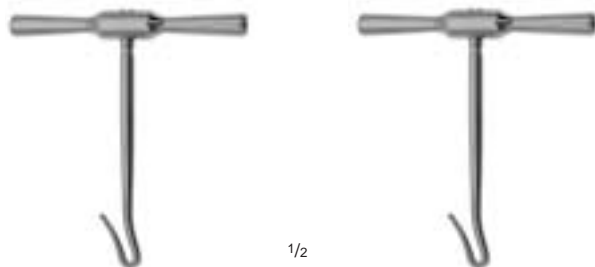

GIGLI
 47-0350
 7 cm, 2 3/4"

Handgriffe für Drahtsägen, 1 Paar
 Hook handles for wire saws, 1 pair
 Mango con gancho, para sierras de hilo, 1 par
 Poignées pour scies, 1 paire
 Manico ad uncino per fili per sega, 1 paio



DE MARTEL (BAILEY)
 50-0335
 33 cm, 13"

Einführungsinstrument für Drahtsägen
 Conductor for wire saws
 Conductor para sierras de hilo
 Conducteur pour scies
 Guida per fili per sega



Schädelzangen
 Cranial Rongeur Forceps
 Pinzas saca-bocado craneal
 Rongeurs crâniens
 Pinze per ossa del cranio



53-0971



53-0976



53-0977



1/2

DAHLGREN
 53-0970
 20 cm, 8"

Schädelstanze mit 2 Haken (53-0971)
 Cranial rongeur with 2 hooks (53-0971)

Pinza saca-bocado craneal con
 2 ganchos (53-0971)

Rongeur crâniens avec 2 crochets
 (53-0971)

Pinza per cranio con 2 ganci (53-0971)



1/2

DE VILBISS
 53-0975
 20,5 cm, 8"

Schädelstanze mit je 1 Haken klein
 (53-0976) und groß (53-0977)

Cranial rongeur with 1 hook each small
 (53-0976) and large (53-0977)

Pinza saca-bocado craneal con 1 gancho
 pequeño (53-0976) y grande (53-0977)

Rongeur crâniens avec 1 crochet petit
 (53-0976) et grand (53-0977)

Pinza per cranio con 1 gancio piccolo
 (53-0976) e 1 grande (53-0977)



1/2

CONE
 50-0255
 22,5 cm, 9"

Schädelstanzzange bis 12 mm
 Schädelstärke

Cranial punch rongeur for maxi-
 mum of 12 mm of bone

Pinza saca-bocados craneal
 para craneo hasta 12 mm

Pince crânienne jusqu'à 12 mm
 épaisness du crâne

Pinza per cranio, asta 12 mm.



CRUTCHFIELD
 48-0518
 ø 3,5 mm

Vorbohrer für CRUTCHFIELD-Schädelhalter

Drill point for CRUTCHFIELD cervical traction tongs

Perforador inicial para pinzas de tracción craneal CRUTCHFIELD

Alésoir pour étrier traction crânienne de CRUTCHFIELD

Alesatore per pinze di trazione craniale di CRUTCHFIELD



CRUTCHFIELD
 48-0517
 ø 5,0 mm

Vorbohrer für CRUTCHFIELD-Schädelhalter

Drill point for CRUTCHFIELD cervical traction tongs

Perforador inicial para pinzas de tracción craneal CRUTCHFIELD

Alésoir pour étrier traction crânienne de CRUTCHFIELD

Alesatore per pinze di trazione craniale di CRUTCHFIELD

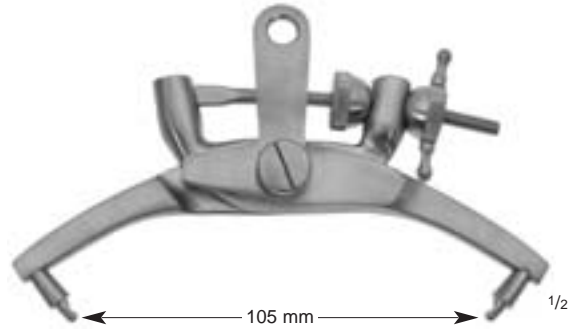

CRUTCHFIELD
 52-0520

Schädelhalter, kleine Größe
 Cervical traction tongs, small size
 Pinza de tracción craneal, tamaño pequeño
 Etrier traction crânienne, petit modèle
 Pinza per trazione craniale, modello piccolo

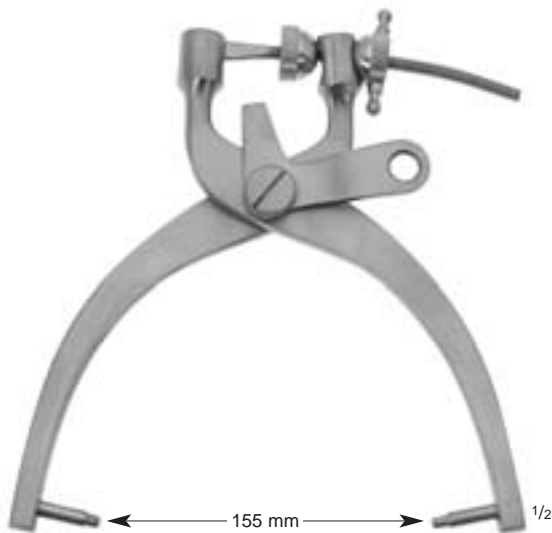

CRUTCHFIELD
 52-0525

Schädelhalter, mittlere Größe
 Cervical traction tongs, medium size
 Pinza de tracción craneal, tamaño mediano
 Etrier traction crânienne, modèle moyen
 Pinza per trazione craniale, modello medio



52-0542

Ersatzdorn
 Spare pin
 Punta de repuesto
 Pointe de rechange seule
 Punta di scorta sola

52-0540

Schädelhalter für Extension der Halswirbel, großes Modell, Dorne verstellbar, deshalb Vorbohren nicht erforderlich

Cervical traction tongs, for extension of the neck vertebrae, large size, pins adjustable hence no initial drilling

Pinza de tracción craneal para la extensión de las vertebrae de cuello, tamaño grande, puntas ajustables suprimiendo perforaciones iniciales

Etrier traction crânienne, pour l'extension des vertèbres cervicales, grand modèle, mandrins réglables supprimant la perforation initiale

Pinza per trazione craniale e l'estensione delle vertebre del collo, modello grande, punte regolabili al fine di evitare la perforazione iniziale



Klammerinstrumentarium
Clip Instruments
Instrumental para grapar
Instruments à suture
Strumenti per mettere i punti



1/1

MC KENZIE
50-0631

Silberklammern in Plastikbehälter,
zu 100 Stück

Silver brain clips in plastic vial, comprising
100 pieces

Grapas de plata en tubo de plástico,
conteniendo 100 piezas

Agrafes en argent, en petit tube en matière
plastique, par 100 pièces

Agrafes di argento, contenuti in piccoli tubi
di materiale plastico, 100 pezzi per tubo



1/1

MC KENZIE
50-0633

Silberdraht zur Herstellung von
Klammern, in Ringen zu 2,5 gr.

Silver wire in coils of 2.5 g

Hilo de plata para producir
grapas, en rollos de 2,5 gr.

Fil d'argent pour fabriquer des
agrafes par rouleaux de 2,5 g

Filo di argento per la costruzione
di agrafer in rotoli da gr. 2,5



1/3

MC KENZIE
50-0635
148 x 40 x 6 mm

Klammerblock mit 1 Klammern-
bügel und 1 Schiebedeckel

Silver clip carrier with 1 clip
holding rack and 1 sliding cover

Porta-grapas con 1 riel para
grapas y 1 tapa corredera

Support porte-agrafes, avec 1 rangée
d'agrafes et 1 couvercle coulissant

Supporto porta-agrafes, con 1 fila
di agrafer e 1 copertura a scorrimento

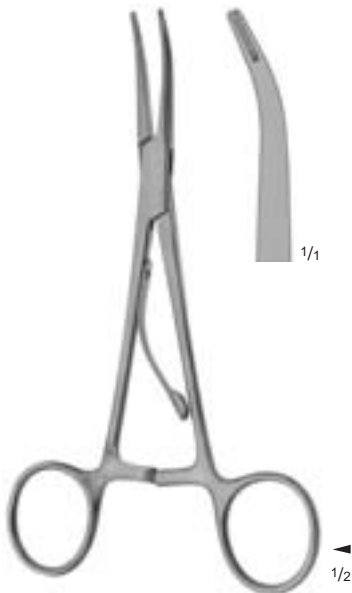

1/1

1/2

MC KENZIE

- ▶ 50-0600 15,5 cm, 6"
- 50-0602 18,5 cm, 7 1/4"

Klammer-Anlegezangen für Silberklammern 50-0631
Clip applying forceps for silver clips 50-0631
Pinzas clipadoras para las grapas de plata 50-0631
Pince pose clips 50-0631
Pinza metti agrafer per agrafer in argento 50-0631

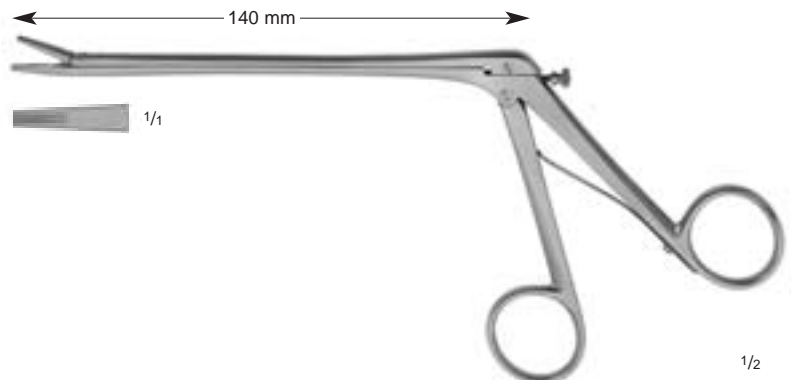

140 mm

1/1

1/2

OLIVECRONA-TOENNIS (SCOVILLE)
50-0679
140 mm

Klammer-Anlegezange für Silberklammern 50-0631
Clip applying forceps for silver clips 50-0631
Pinza para colocar las grapas de plata 50-0631
Pince pose clips 50-0631
Pinza metti agrafer per agrafer in argento 50-0631



MOD. KÖLN
 50-0649

Kopfhautklammern, in Packungen zu 10 Stück

Scalp hemostasis clips, in packages of 10 pieces

Pinza hemostática para cuero cabelludo, en paquetes de 10 piezas

Agrafes hémostatiques pour cuir chevelu en paquets de 10 pièces

Agrafes emostatici per cuoio capelluto, in confezioni da 10 pezzi



RANEY
 50-0658

Kopfhautklammern, in Packungen zu 12 Stück

Scalp hemostasis clips, in packages of 12 pieces

Pinza hemostática para cuero cabelludo, en paquetes de 12 piezas

Agrafes hémostatiques pour cuir chevelu en paquets de 12 pièces

Agrafes emostatici per cuoio capelluto, in confezioni da 12 pezzi

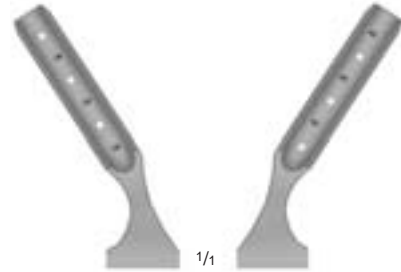

RANEY
 50-0650
 16 cm, 6 1/4"

Anlege- und Abnehmzange für Kopfhautklammern 50-0658

Applying and removing forceps for scalp hemostasis clips 50-0658

Pinza para aplicar y quitar clips hemostáticas de cuero cabelludo 50-0658

Pince pour poser et retirer les clips hémostatiques du cuir chevelu 50-0658

Pinza per applicare e togliere le agrafes emostatiche al cuoio capelluto 50-0658

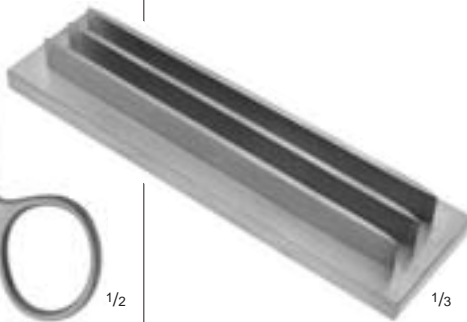

RANEY
 50-0652
 180 x 50 x 25 mm

Klammerblock mit 3 Klammernbügeln

Scalp hemostasis clip carrier with 3 clip holding racks

Porta-grapas con 3 rieles para grapas

Support porte-agraves, avec 3 rangées d'agrafes

Supporto porta-agraves, con 3 file di agrafes

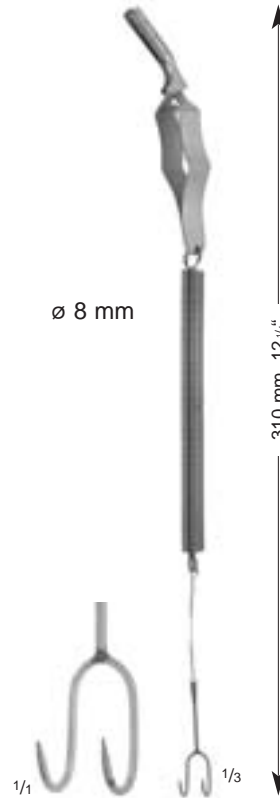

YASARGIL
 52-0252
 31 cm, 12 1/4"

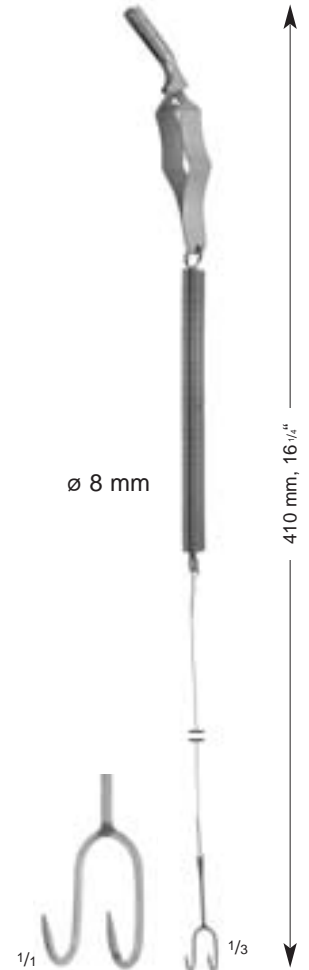

YASARGIL
 52-0254
 41 cm, 16 1/4"

Federhaken zur Galea-Fixation mit Bulldogklemme zum Befestigen am Abdecktuch
 Spring hooks for galea fixation with bulldog clamp, to be fastened to covering drape
 Ganchos con muelle para la fijación de la galea, con pinza de bulldog para agarrar tela
 Crochets à muelle pour fixer la galea, avec pince bulldog pour fixer au champ opératoire
 Ganci a molla per fissare la galea con clamp bulldog, da applicare al telo di copertura



Hypophysektomie-Instrumente
 Pituitary Instruments
 Instrumentos para la hipofisectomía
 Instruments pour la hypophysectomie
 Strumenti per ipofisi



LANDOLT-CUSHING
 51-0540 \varnothing 15 mm x 70 mm
 ▶ 51-0541 \varnothing 15 mm x 90 mm

Spekula für trans-sphenoidale
 Hypophysektomie
 Specula for trans-sphenoidal
 hypophysectomy
 Espéculos para la hipofisectomía
 trans-sfenoidal
 Spécula pour la hypophysectomie
 transsphénoïdale
 Speculo per ipofisectomia trans-
 sfenoidale

1/2

\varnothing 4 mm

\varnothing 4 mm

\varnothing 4 mm



1/1

1/1

1/1

RAY

▶ 51-0528
 18,5 cm, 7 1/4"

Kürette, horizontal
 45°

Curette, horizontal
 45°

Cureta horizontal
 45°

Curette horizontale
 45°

Curetta orizzontale
 45°

RAY

51-0524
 18,5 cm, 7 1/4"

Kürette, horizontal
 90°

Curette, horizontal
 90°

Cureta horizontal
 90°

Curette horizontale
 90°

Curetta orizzontale
 90°

RAY

51-0534
 18,5 cm, 7 1/4"

Kürette, vertikal
 45°

Curette, vertical
 45°

Cureta vertical
 45°

Curette verticale
 45°

Curetta verticale
 45°

1/2



\varnothing 4 mm



\varnothing 6 mm



1/1

1/1

HARDY

▶ 51-0577
 26 cm, 10 1/4"

Kürette, horizontal
 90°, biegsam

Curette, horizontal
 90°, malleable

Cureta horizontal
 90°, maleable

Curette horizontale
 90°, malléable

Curetta orizzontale
 90°, malleabile

HARDY

51-0578
 26 cm, 10 1/4"

Kürette, horizontal
 90°, biegsam

Curette, horizontal
 90°, malleable

Cureta horizontal
 90°, maleable

Curette horizontale
 90°, malléable

Curetta orizzontale
 90°, malleabile

1/2

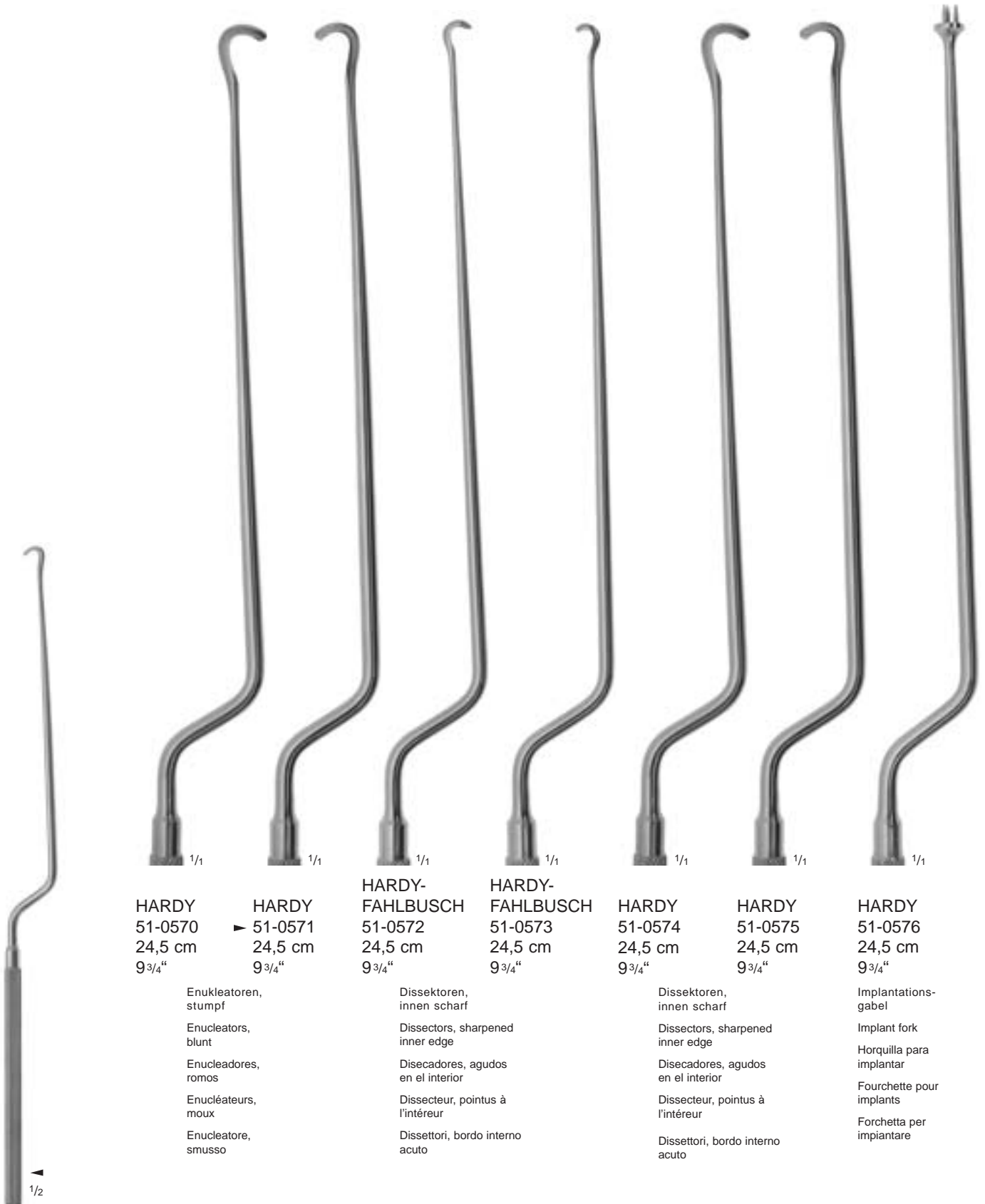

HARDY
 51-0570
 24,5 cm
 9 3/4"

Enukleatoren,
 stumpf
 Enucleators,
 blunt
 Enucleadores,
 romos
 Enucléateurs,
 moux
 Enucleatore,
 smusso

HARDY
 51-0571
 24,5 cm
 9 3/4"

HARDY-
 FAHLBUSCH
 51-0572
 24,5 cm
 9 3/4"

Dissektoren,
 innen scharf
 Dissectors, sharpened
 inner edge
 Disecadores, agudos
 en el interior
 Dissecteur, pointus à
 l'intérieur
 Dissettori, bordo interno
 acuto

HARDY-
 FAHLBUSCH
 51-0573
 24,5 cm
 9 3/4"

HARDY
 51-0574
 24,5 cm
 9 3/4"

Dissektoren,
 innen scharf
 Dissectors, sharpened
 inner edge
 Disecadores, agudos
 en el interior
 Dissecteur, pointus à
 l'intérieur
 Dissettori, bordo interno
 acuto

HARDY
 51-0575
 24,5 cm
 9 3/4"

HARDY
 51-0576
 24,5 cm
 9 3/4"

Implantations-
 gabel
 Implant fork
 Horquilla para
 implantar
 Fourchette pour
 implants
 Forchetta per
 impiantare



Mikro-Instrumente
 Micro Instruments
 Instrumentos para microcirugía
 Instruments pour microchirurgie
 Strumenti per microchirurgia



JACOBSON
 57-0080
 18,5 cm, 7 1/4"
 Knopfsonde
 Buttoned probe
 Sonda abotonada
 Sonde boutonée
 Sonda bottonuta



JACOBSON
 57-0085
 18,5 cm, 7 1/4"
 Doppelsonde
 Twin probe
 Sonda doble
 Sonde double
 Sonda doppia



JACOBSON
 57-0090
 18,5 cm, 7 1/4"
 Fadengabel
 Suture pusher
 Empujador de sutura
 Fourche à fil
 Punzone per sutura



YASARGIL
 ▶ 57-0115
 18,5 cm, 7 1/4"
 Raspatorium
 Raspatory
 Legra
 Rugine-raspatoire
 Periostotomo



YASARGIL
 57-0175
 18,5 cm, 7 1/4"
 Dissektor
 Dissector
 Disecador
 Dissecteur
 Dissetto



YASARGIL
 57-0110
 18,5 cm, 7 1/4"
 Raspatorium
 Raspatory
 Legra
 Rugine-raspatoire
 Periostotomo



YASARGIL
 57-0100
 18,5 cm, 7 1/4"
 Raspatorium
 Raspatory
 Legra
 Rugine-raspatoire
 Periostotomo



YASARGIL
 57-0105
 18,5 cm, 7 1/4"
 Raspatorium
 Raspatory
 Legra
 Rugine-raspatoire
 Periostotomo



JACOBSON
 57-0095
 18,5 cm, 7 1/4"
 Gefäßmesser
 Vessel knife
 Cuchillo para vasos
 Couteau pour vaisseaux
 Bisturi per vasi



1/1
YASARGIL
 57-0130
 18,5 cm, 7 1/4"
 Raspatorium
 Raspatory
 Legra
 Rugine-raspatoire
 Periototomo



1/1
YASARGIL
 57-0120
 18,5 cm, 7 1/4"
 Raspatorium
 Raspatory
 Legra
 Rugine-raspatoire
 Periototomo



1/1
YASARGIL
 57-0125
 18,5 cm, 7 1/4"
 Raspatorium
 Raspatory
 Legra
 Rugine-raspatoire
 Periototomo



1/1
YASARGIL
 57-0050
 18,5 cm, 7 1/4"
 Scharfer Löffel
 Scoop
 Cucharilla cortante
 Curette tranchante
 Curetta tagliente



1/1
YASARGIL
 57-0098
 18,5 cm, 7 1/4"
 Gefäßmesser
 Vessel knife
 Cuchillo para vasos
 Couteau pour vaisseaux
 Bisturi per vasi



1/1
YASARGIL
 57-0099
 18,5 cm, 7 1/4"
 Gefäßmesser
 Vessel knife
 Cuchillo para vasos
 Couteau pour vaisseaux
 Bisturi per vasi



1/2

1/1
KOOS
 57-0091
 18,5 cm, 7 1/4"
 Gefäßmesser
 Vessel knife
 Cuchillo para vasos
 Couteau pour vaisseaux
 Bisturi per vasi



1/1
KOOS
 57-0094
 18,5 cm, 7 1/4"
 Gefäßmesser
 Vessel knife
 Cuchillo para vasos
 Couteau pour vaisseaux
 Bisturi per vasi



1/1
KOOS
 57-0092
 18,5 cm, 7 1/4"
 Gefäßmesser
 Vessel knife
 Cuchillo para vasos
 Couteau pour vaisseaux
 Bisturi per vasi



1/1
KOOS
 57-0093
 18,5 cm, 7 1/4"
 Gefäßmesser
 Vessel knife
 Cuchillo para vasos
 Couteau pour vaisseaux
 Bisturi per vasi



1/1
KRAUS
 57-0096
 18,5 cm, 7 1/4"
 Gefäßmesser
 Vessel knife
 Cuchillo para vasos
 Couteau pour vaisseaux
 Bisturi per vasi

Schneide seitlich
 lateral cutting edge
 filo de corte lateral
 tranchant latéral
 taglio laterale



► 57-0132
23 cm, 9"
Häkchen
Hook
Gancho
Crochet
Uncino

1/1



57-0134
23 cm, 9"
Häkchen
Hook
Gancho
Crochet
Uncino

1/1



57-0136
23 cm, 9"
Dissektor
Dissector
Disecador
Dissecteur
Dissettore

1/1



57-0138
23 cm, 9"
Dissektor
Dissector
Disecador
Dissecteur
Dissettore

1/1



1/2

57-0132
- 57-0148



57-0142
23 cm, 9"
Raspatorium
Raspatory
Legra
Rugine-raspatoire
Periostotomo

1/1



57-0144
23 cm, 9"
Raspatorium
Raspatory
Legra
Rugine-raspatoire
Periostotomo

1/1



57-0146
23 cm, 9"
Scharfer Löffel
Scoop
Cucharilla cortante
Curette tranchante
Curetta tagliente

1/1



57-0148
23 cm, 9"
Scharfer Löffel
Scoop
Cucharilla cortante
Curette tranchante
Curetta tagliente

1/1



▶ 57-0150
 23 cm
 9"

Dissektor
 Dissector
 Disecador
 Dissecteur
 Dissettore

57-0152
 23 cm
 9"

Dissektor
 Dissector
 Disecador
 Dissecteur
 Dissettore

57-0154
 23 cm
 9"

Raspatorium
 Raspatory
 Legra
 Rugine-raspatoire
 Periostotomo

57-0150
 - 57-0154

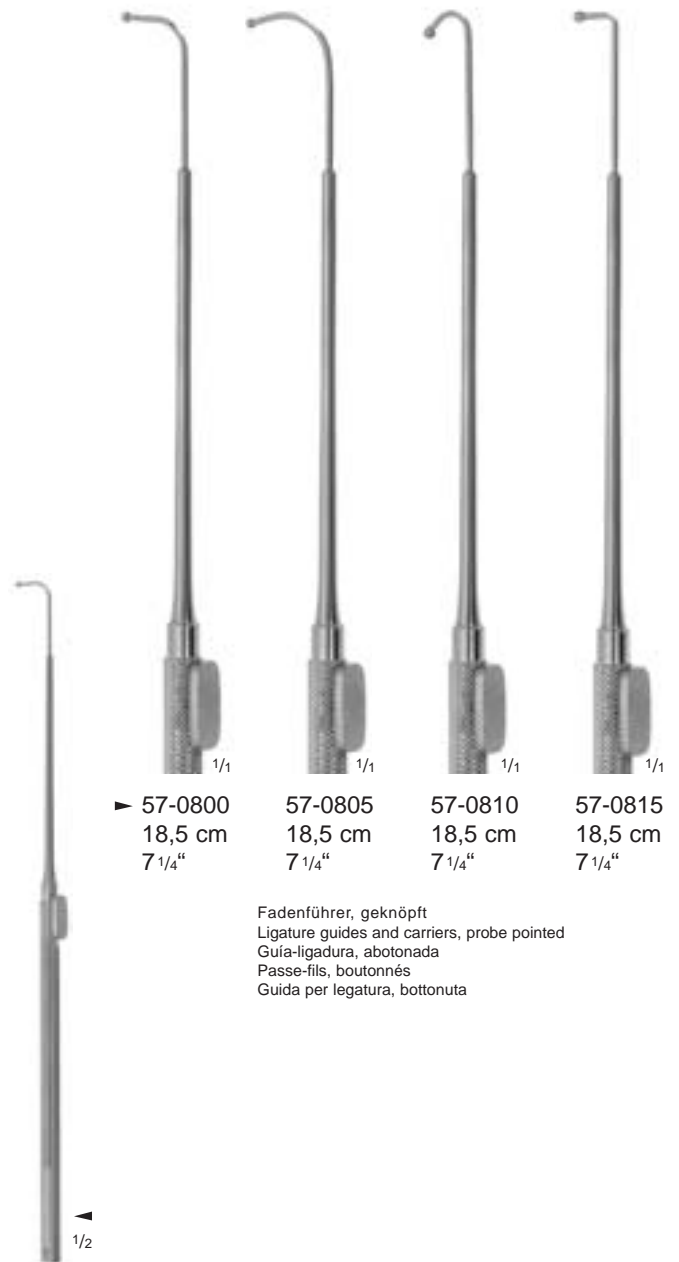

▶ 57-0800
 18,5 cm
 7 1/4"

57-0805
 18,5 cm
 7 1/4"

57-0810
 18,5 cm
 7 1/4"

57-0815
 18,5 cm
 7 1/4"

Fadenführer, geknöpft
 Ligature guides and carriers, probe pointed
 Guía-ligadura, abotonada
 Passe-fils, boutonnés
 Guida per legatura, bottonuta

YASARGIL
 57-0800
 - 57-0815



Dura-Separatoren
Dura Separators
Disecadores de dura-madre
Dissecteurs pour la dure-mère
Dissettori per la dura-madre

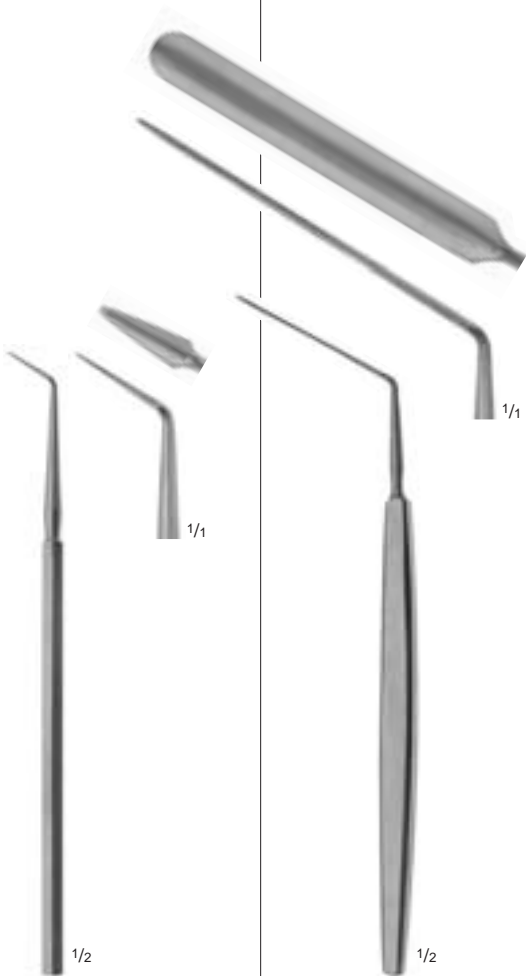

FRAZIER
51-0745
16,5 cm, 6 1/2"

HORSLEY
51-0730
18,5 cm, 7 1/4"



MILLIGAN
51-0731
21 cm, 8 1/4"



SACHS
51-0735
20 cm, 8"

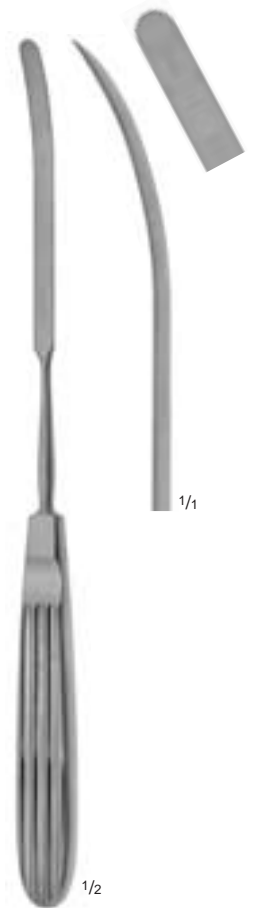

SACHS
51-0729
23 cm, 9"



PENFIELD
 51-0790
 17,5 cm, 7"



PENFIELD
 51-0792
 19,5 cm, 7³/₄"



PENFIELD
 51-0794
 19,5 cm, 7³/₄"



PENFIELD
 51-0796
 21,5 cm, 8¹/₂"



PENFIELD
 51-0798
 29 cm, 11¹/₂"



Dura-Dissektoren
Dura Dissectors
Disecadores para dura-madre
Dissecteurs à dure-mère
Dissettori per la dura-madre



TOENNIS
51-0634
24 cm, 9 1/2"



TOENNIS
51-0636
24 cm, 9 1/2"



OLIVECRONA
51-0640 18 cm, 7"
▶ 51-0641 24 cm, 9 1/2"



OLIVECRONA
51-0643 19,5 cm, 7 3/4"
▶ 51-0644 24,0 cm, 9 1/2"

Nervwurzelhaken
Nerve Root Retractors
Separadores para la raíz de nervios
Rétracteurs pour racines nerveuses
Separatori per le radici dei nervi

Dekompressionshaken
Decompression Hook
Ganchos para decompresión
Crochets pour décompression
Ganci per decompressione



LOVE
52-0200
20,5 cm, 8"

Nervwurzelhaken
Nerve root retractor
Separador para la raíz de nervios
Rétracteur pour racines nerveuses
Separatore per le radici dei nervi

1/2



45°

LOVE
52-0205
18 cm, 7"

Nervwurzelhaken
Nerve root retractor
Separador para la raíz de nervios
Rétracteur pour racines nerveuses
Separatore per le radici dei nervi

1/2



90°

LOVE
52-0210
14 cm, 5 1/2"

Nervwurzelhaken
Nerve root retractor
Separador para la raíz de nervios
Rétracteur pour racines nerveuses
Separatore per le radici dei nervi

1/2



LOVE
52-0202
22,5 cm, 9"

Nervwurzelhaken
Nerve root retractor
Separador para la raíz de nervios
Rétracteur pour racines nerveuses
Separatore per le radici dei nervi

1/2



SCOVILLE
52-0212
23 cm, 9"

Nervwurzelhaken
Nerve root retractor
Separador para la raíz de nervios
Rétracteur pour racines nerveuses
Separatore per le radici dei nervi

1/2



HOLSHER
52-0214
24 cm, 9 1/2"

Nervwurzelhaken
Nerve root retractor
Separador para la raíz de nervios
Rétracteur pour racines nerveuses
Separatore per le radici dei nervi

1/2

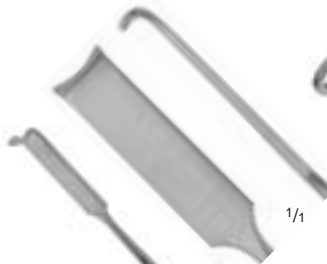

SCOVILLE
52-0216
20 cm, 8"

Nervwurzelhaken
Nerve root retractor
Separador para la raíz de nervios
Rétracteur pour racines nerveuses
Separatore per le radici dei nervi

1/2

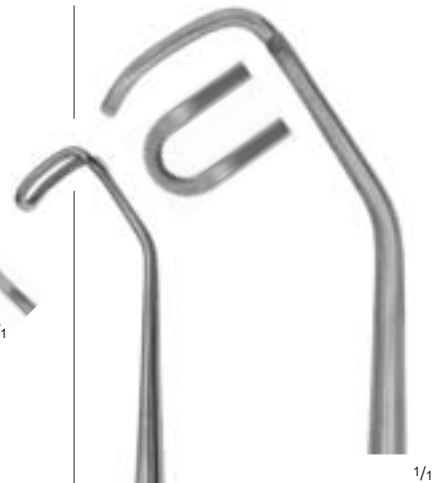

CUSHING
52-0250
21 cm, 8 1/4"

Dekompressionshaken
Decompression hook
Gancho para decompresión
Crochet pour décompression
Gancio per decompressione

1/2



Retraktoren zur Fixation am Schädel

Self-Retaining Retractors, for Skull Mounting

Separadores para la fijación del cráneo

Ecarteurs autofixant au crâne

Autofissatore per retrattori, per il supporto del cranio



LEYLA

52-0220

Selbsthaltender Hirnspatel mit 1 Spannarm, komplett, bestehend aus:

- 52-0224 1 Spannarm, flexibel
- 52-0226 1 Fixiervorrichtung für 1 Spannarm
- 52-0234 1 Spatelhalter für flache Spatel

Self-retaining brain retractor with 1 arm, complete, consisting of:

- 52-0224 1 Flexible arm
- 52-0226 1 Fixation base for 1 arm
- 52-0234 1 Support for flat brain spatulas

Separador automático para el cerebro con 1 brazo, completo, compuesto de:

- 52-0224 1 Brazo, flexible
- 52-0226 1 Fijador para 1 brazo
- 52-0234 1 Porta-espátula para espátulas planas

Ecarteur autofixant au crâne avec 1 bras

complet, composé de:

- 52-0224 1 Bras flexible
- 52-0226 1 Base de fixation pour 1 bras
- 52-0234 1 Support pour spatules plats

Autofissatore per retrattore cervicale con 1 braccio, completo, composto da:

- 52-0224 1 Braccio flessibile
- 52-0226 1 Base di fissaggio per 1 braccio
- 52-0234 1 Supporto per spatole cervicali piatte

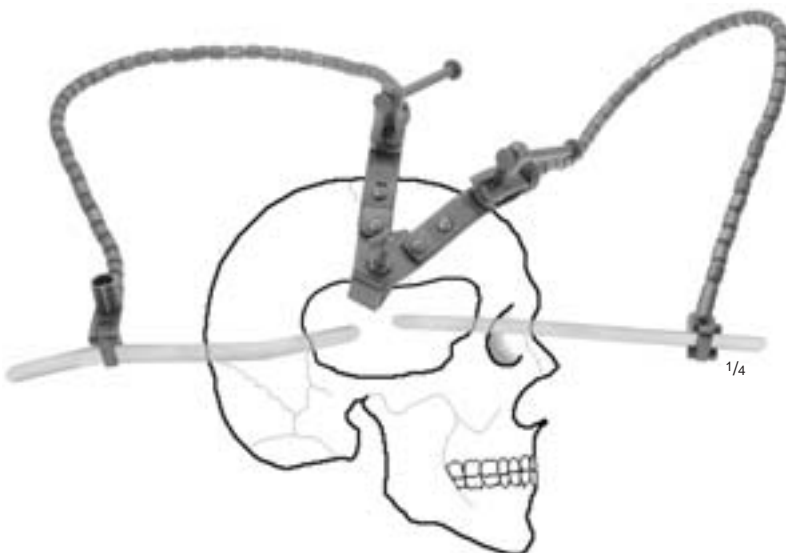

LEYLA

52-0222

Selbsthaltender Hirnspatel mit 2 Spannarmen, komplett, bestehend aus:

- 52-0224 2 Spannarme, flexibel
- 52-0228 1 Fixiervorrichtung für 2 Spannarme
- 52-0234 2 Spatelhalter für flache Spatel

Self-retaining brain retractor with 2 arms, complete, consisting of:

- 52-0224 2 Flexible arms
- 52-0228 1 Fixation base for 2 arms
- 52-0234 2 Supports for flat brain spatulas

Separador automático para cerebro con 2 brazos, completo, compuesto de:

- 52-0224 2 Brazos, flexibles
- 52-0228 1 Fijador para 2 brazos
- 52-0234 2 Porta-espátula para espátulas planas

Ecarteur autofixant au crâne avec 2 bras

complet, composé de:

- 52-0224 2 Bras flexible
- 52-0228 1 Base de fixation pour 2 bras
- 52-0234 2 Support pour spatules plats

Autofissatore per retrattore cervicale con 2 bracci, completo, composto da:

- 52-0224 2 Bracci flessibili
- 52-0228 1 Base di fissaggio per 2 bracci
- 52-0234 2 Supporti per spatole cervicali piatte

Zubehör zu LEYLA-Retraktoren

Accessories for LEYLA Self-Retaining Retractors
Accesorios para separadores automáticos de LEYLA
Accessoires pour écarteurs autofixants de LEYLA
Accessori per autofissatori di retrattori di LEYLA



1/4

LEYLA 52-0224

**Spannarm, zum Aufstecken auf Kupplungsköpfe 52-0244/
52-0246 und Fixiervorrichtungen 52-0226/52-0228/52-0230**

Flexible arm for attaching coupling heads 52-0244/52-0246
and fixaton bases 52-0226/52-0228/52-0230

Brazo para colocar sobre el acoplamiento 52-0244/52-0246
y los fijadores 52-0226/52-0228/52-0230

Bras flexible pour fixation aux têtes d'accouplement 52-0244/
52-0246 et base de fixation 52-0226/52-0228/52-0230

Braccio flessibile per il fissaggio delle teste di accoppiamento
52-0244/52-0246 e le basi di fissaggio 52-0226/52-0228/52-0230



1/2

LEYLA 52-0226

**Fixiervorrichtung für 1 Spannarm 52-0224, zum Fest-
schrauben am Schädel**

Fixation base for 1 flexible arm 52-0224, for skull mounting

Fijador para 1 brazo 52-0224, para atornillar al cráneo

Base de fixation pour 1 bras 52-0224, pour fixer au crâne

Base di fissaggio per 1 braccio flessibile 52-0224, per il
supporto del cranio



1/2

LEYLA 52-0228

**Fixiervorrichtung für 2 Spannarme 52-0224, zum Fest-
schrauben am Schädel**

Fixation base for 2 flexible arms 52-0224, for skull mounting

Fijador para 2 brazos 52-0224, para atornillar al cráneo

Base de fixation pour 2 bras 52-0224, pour fixer au crâne

Base di fissaggio per 2 bracci flessibili 52-0224, per il
supporto del cranio



1/2

LEYLA 52-0230

**Fixiervorrichtung für 1 Spannarm 52-0224, zum Fest-
schrauben an Rohrteilen bis ø 16 mm**

Fixation base for 1 flexible arm 52-0224, for mounting to
bars up to 16 mm diam.

Fijador para 1 brazo 52-0224, para atornillar a tubos
hasta 16 mm

Base de fixation pour 1 bras 52-0224, pour fixer aux tubes
jusqu' à ø 16 mm

Base di fissaggio per 1 braccio flessibile 52-0224, per il
supporto di asta di raccordo da 16 mm



1/2

LEYLA 52-0232

**Spatelhalter mit Rundschaft bis ø 5,5 mm, zur Befestigung
am Spannarm 52-0224**

Support for brain spatulas with round shaft up to 5.5 mm diam.,
fixation to flexible arm 52-0224

Porta-espátula con vástago redondo hasta ø 5,5 mm, para
sujetarlo al brazo 52-0224

Support pour spatules avec tiges ronds jusqu' à ø 5,5 mm,
pour fixation au bras

Supporto per spatola craniale con diametro asse 5,5 mm, fissato
al braccio flessibile 52-0224



1/2

LEYLA 52-0234

**Spatelhalter für flache Spatel, zur Befestigung am Spannarm
52-0224**

Support for flat brain spatulas, fixation to flexible arm 52-0224

Porta-espátula para espátulas planas, para sujetarlo al brazo
52-0224

Support pour tiges plats pour fixation 52-0224

Supporto per spatola cervicale piatta, fissato al braccio flessibile
52-0224



Retraktoren zur Fixation am OP-Tisch

Self-Retaining Retractors, Fixation to Operating Table

Separadores para fijación a la mesa de operaciones

Ecarteurs pour fixation à la table d'opération

Autofissatori per retrattori, da fissare alla tavola operatoria



LEYLA

52-0236

Selbsthaltender Hirnspatel mit 1 Spannarm, komplett, bestehend aus:

- 52-0240 1 Kugelgelenkkloben
- 52-0242 1 Haltearm
- 52-0244 1 Kupplungskopf
- 52-0224 1 Spannarm
- 52-0232 1 Spatelhalterung für Spatel mit rundem Griff

Self-retaining brain retractor with 1 flexible arm, complete, consisting of:

- 52-0240 1 Ball and socket joint
- 52-0242 1 Holding rod
- 52-0244 1 Coupling head
- 52-0224 1 Flexible arm
- 52-0232 1 Support, for brain spatulas with round shaft

Separador automático para el cerebro con 1 brazo, completo, compuesto de:

- 52-0240 1 Articulación esférica
- 52-0242 1 Brazo de apoyo
- 52-0244 1 Acoplamiento
- 52-0224 1 Brazo
- 52-0232 1 Porta-espátula para espátulas con mangos redondos

Ecarteur du cerveau autofixant avec 1 bras complet, composé de:

- 52-0240 1 Articulation sphérique
- 52-0242 1 Bras de fixation
- 52-0244 1 Tête d'accouplement
- 52-0224 1 Bras flexible
- 52-0232 1 Support pour spatules avec manches ronds

Autofissatore per retrattori cervicali con 1 braccio flessibile completo, composto da:

- 52-0240 1 Giunto a sfera ad incastro
- 52-0242 1 Porta asta
- 52-0244 1 Testa accoppiamento
- 52-0224 1 Braccio flessibile
- 52-0232 1 Supporto per spatola craniale con albero rotondo



LEYLA

52-0238

Selbsthaltender Hirnspatel mit 2 Spannarmen, komplett, bestehend aus:

- 52-0240 1 Kugelgelenkkloben
- 52-0242 1 Haltearm
- 52-0246 2 Kupplungsköpfe
- 52-0224 2 Spannarme
- 52-0234 1 Spatelhalterung, für flache Spatel
- 52-0232 1 Spatelhalterung, für Spatel mit rundem Griff

Self-retaining brain retractor with 2 flexible arms, complete, consisting of:

- 52-0240 1 Ball and socket joint
- 52-0242 1 Holding rod
- 52-0246 2 Coupling heads
- 52-0224 2 Flexible arms
- 52-0234 1 Support, for flat brain spatulas
- 52-0232 1 Support, for brain spatulas with round shaft

Separador automático para el cerebro con 2 brazos, completo, compuesto de:

- 52-0240 1 Articulación esférica
- 52-0242 1 Brazo de apoyo
- 52-0246 2 Acoplamientos
- 52-0224 2 Brazos
- 52-0234 1 Porta-espátula, para espátulas planas
- 52-0232 1 Porta-espátula, para espátulas con mangos redondos

Ecarteur du cerveau autofixant avec 2 bras complet, composé de:

- 52-0240 1 Articulation sphérique
- 52-0242 1 Bras de fixation
- 52-0246 2 Têtes d'accouplement
- 52-0224 2 Bras flexibles
- 52-0234 1 Support pour spatules plats
- 52-0232 1 Support pour spatules avec manches ronds

Autofissatore per retrattori cervicali con 2 bracci flessibili completo, composto da:

- 52-0240 1 Giunto a sfera ad incastro
- 52-0242 1 Porta asta
- 52-0246 2 Teste accoppiamento
- 52-0224 2 Bracci flessibili
- 52-0234 1 Supporto per spatola craniale piatta
- 52-0232 1 Supporto per spatola craniale con albero rotondo

Zubehör zu LEYLA-Retraktoren

Accessories for LEYLA Self-Retaining Retractors
Accesorios para separadores automáticos de LEYLA
Accessoires pour écarteurs LEYLA
Accessori per autofissatori per retrattori di LEYLA



1/4

LEYLA 52-0240

Kugelgelenkkloben, zur Befestigung des Haltearms 52-0242 an OP-Tisch-Schienen

Ball and socket joint, for fixation rod 52-0242 to pole of operating table

Articulación esférica, para sujetar los brazos de apoyo 52-0242 sobre la mesa de operaciones

Articulation sphérique pour fixation du bras 52-0242 aux bandes de la table d'opération

Giunto a sfera ad incastro, per il fissaggio dell'asta 52-0242 all'estremità del tavolo operatorio

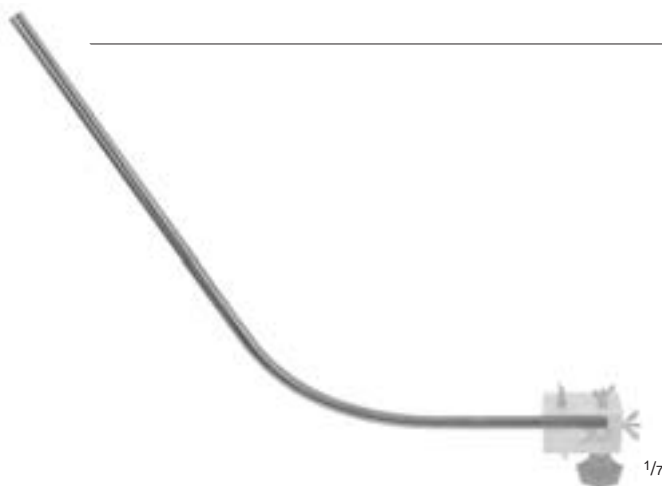

1/7

LEYLA 52-0242

Haltearm zur Fixation im Kugelgelenkkloben 52-0240 und zur Aufnahme der Kupplungsköpfe 52-0244/52-0246

Holding rod for fixation in ball and socket joint 52-0240 and to take coupling heads 52-0244/52-0246

Brazo de apoyo para fijar la articulación esférica 52-0240 y los acoplamientos 52-0244/52-0246

Bras de fixation à l'articulation sphérique 52-0240 et aux têtes d'accouplement 52-0244/52-0246

Porta asta per il fissaggio al giunto a sfera 52-0240 e alle teste di accoppiamento 52-0244/52-0246



1/4

LEYLA 52-0244

Kupplungskopf zur Aufnahme von 1-5 Spannarmen 52-0224

Coupling head to take 1-5 flexible arms 52-0224

Acoplamiento para sujetar 1-5 brazos 52-0224

Tête d'accouplement pour 1-5 bras flexibles 52-0224

Testa accoppiamento per 1-5 bracci flessibili 52-0224



1/4

LEYLA 52-0246

Kupplungskopf, drehbar, in allen Ebenen fixierbar, zur Aufnahme von 1 Spannarm 52-0224

Coupling head, turnable, can be fixed in any position, to take 1 flexible arm 52-0224

Acoplamiento, girable y se puede fijar en todas las posturas para sujetar un brazo 52-0224

Tête d'accouplement, rotative, peut être fixée en toute position, pour tenir 1 bras flexible

Testa accoppiamento, può essere fissato in qualsiasi posizione, supporta 1 braccio flessibile 52-0224



Hirnspatel
Brain Spatulas
Espátulas cerebrales
Spatules cérébrales
Spatole cerebrali



DAVIS
52-0290 13 mm x 190 mm
▶ 52-0291 16 mm x 190 mm
biegsam
malleable
maleables
malléables
malleabili



CUSHING
52-0298
10 + 12 mm x 195 mm

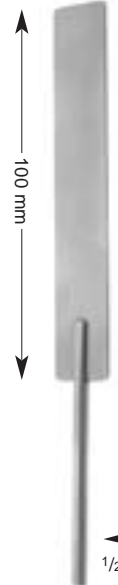

HEIFETZ
52-0261 8 mm x 155 mm
52-0262 11 mm x 155 mm
52-0263 14 mm x 155 mm
▶ 52-0264 17 mm x 155 mm
biegsam
malleable
maleables
malléables
malleabili

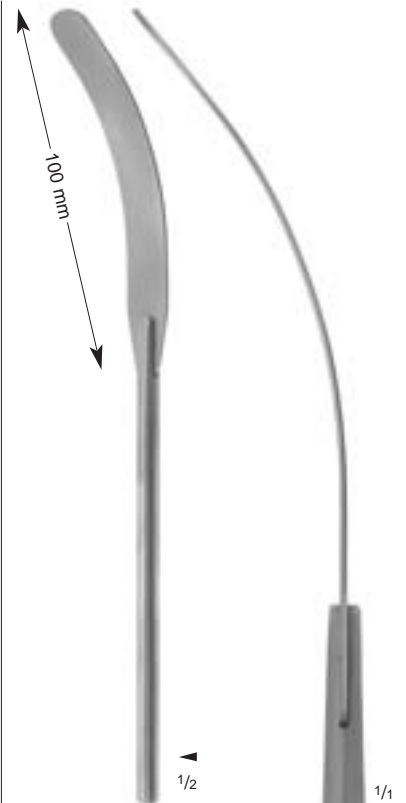

HEIFETZ
52-0265 14 mm x 200 mm
▶ 52-0266 17 mm x 200 mm
52-0267 20 mm x 200 mm
biegsam
malleable
maleables
malléables
malleabili

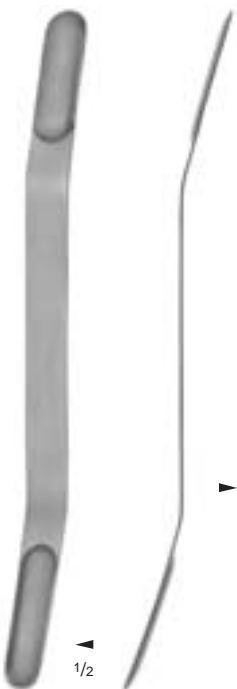

OLIVECRONA
52-0300 7 + 9 mm x 180 mm
▶ 52-0301 11 + 13 mm x 180 mm
52-0302 15 + 18 mm x 180 mm
52-0303 19 + 21 mm x 180 mm
konvex
convex
cónvexas
convexes
convesso

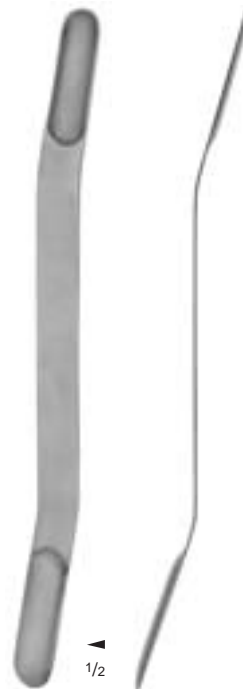

OLIVECRONA
52-0304 7 + 9 mm x 180 mm
▶ 52-0305 11 + 13 mm x 180 mm
52-0306 15 + 18 mm x 180 mm
52-0307 19 + 21 mm x 180 mm
konkav
concave
cóncavas
concaves
concavo

Laminektomie-Stanzen

Laminectomy Punches

Pinzas cortantes para laminectomía

Pinces emporte-pièce à laminectomie

Pinze per laminectomia



63-2710
2 mm



► **63-2711**
3 mm

CITELLI
63-2710
- **63-2711**

nach oben schneidend 90°
upwards cutting 90°
cortante hacia arriba 90°
coupant vers le haut 90°
taglio a 90° verso l'alto

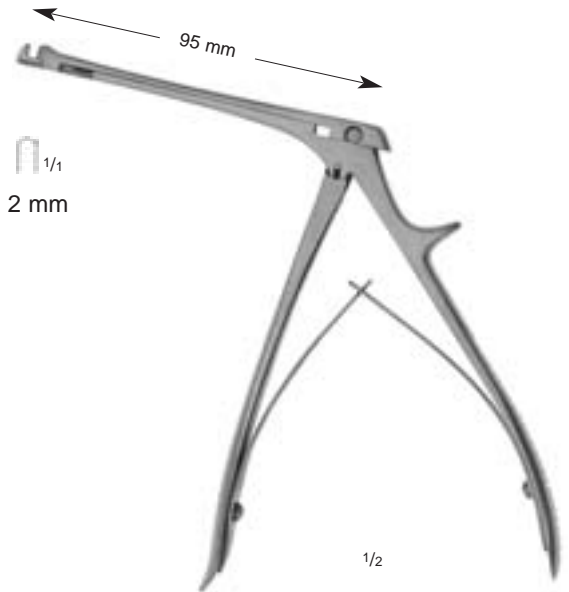

63-2720
2 mm

BEYER
63-2720

nach oben schneidend 90°
upwards cutting 90°
cortante hacia arriba 90°
coupant vers le haut 90°
taglio a 90° verso l'alto



45-0790
3 mm



► **45-0791**
4 mm



45-0792
5 mm



45-0793
6 mm

| | Bissbreite Width of bite Anchura de la boca Largeur des mors Larghezza del morso | Schaftlänge Length of shaft Longitud del vástago Longueur de la tige Lunghezza dell'asta |
|------------------|---|---|
| 45-0790 | 3 mm | 90 mm |
| ► 45-0791 | 4 mm | 90 mm |
| 45-0792 | 5 mm | 90 mm |
| 45-0793 | 6 mm | 90 mm |

KERRISON
45-0790
- **45-0793**

nach oben schneidend 90°
upwards cutting 90°
cortante hacia arriba 90°
coupant vers le haut 90°
taglio a 90° verso l'alto



Laminektomie-Stanzen

Laminectomy Punches

Pinzas cortantes para laminectomía

Pinces emporte-pièce à laminectomie

Pinze per laminectomia

140 mm

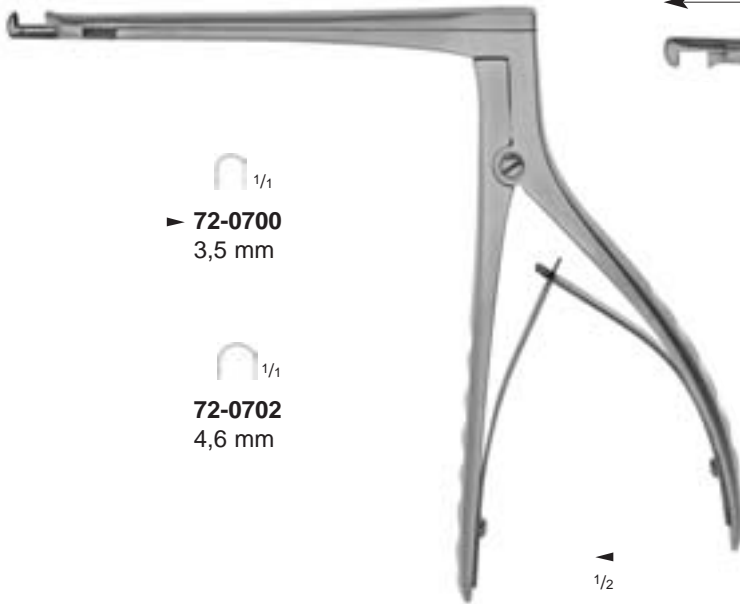

 ^{1/1}
▶ **72-0700**
3,5 mm

 ^{1/1}
72-0702
4,6 mm

1/2

HAJEK-KOFLER
72-0700
- **72-0702**

nach oben schneidend 90°
upwards cutting 90°
cortante hacia arriba 90°
coupant vers le haut 90°
taglio a 90° verso l'alto

140 mm

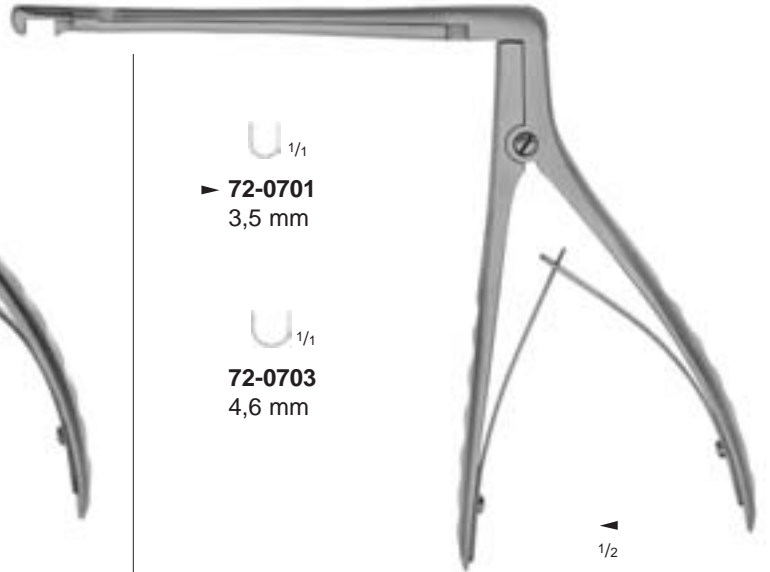

 ^{1/1}
▶ **72-0701**
3,5 mm

 ^{1/1}
72-0703
4,6 mm

1/2

HAJEK-KOFLER
72-0701
- **72-0703**

nach unten schneidend 90°
downwards cutting 90°
cortante hacia abajo 90°
coupant vers le bas 90°
taglio a 90° verso il basso

170 mm

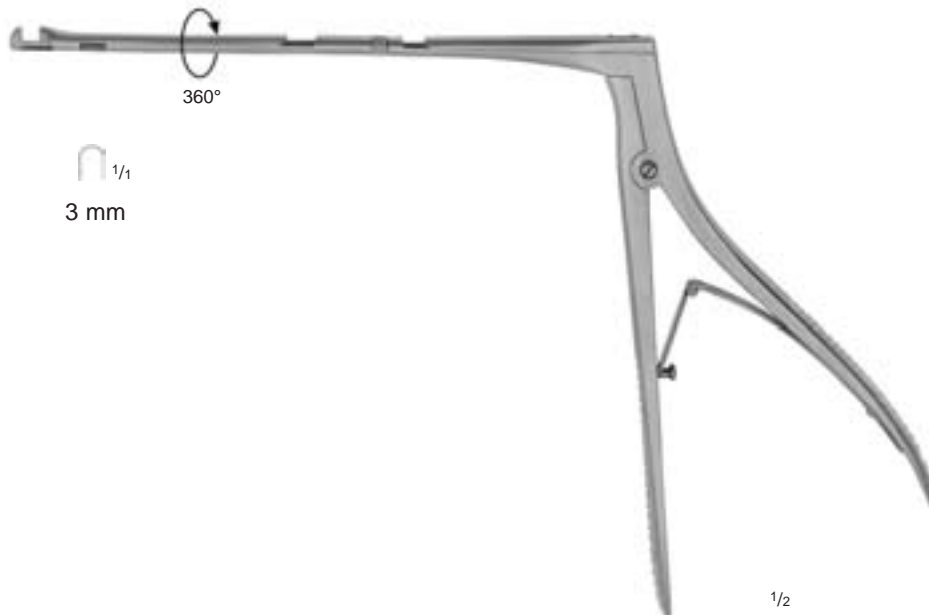

360°

 ^{1/1}
3 mm

1/2

HAJEK-KOFLER
72-0710
3 mm

90° schneidend, Schaft 360° drehbar
90° cutting, shaft rotates 360°
corte 90°, vástago girable 360°
coupant à 90°, tige tournant 360°
taglio a 90°, albero rotante di 360°

Laminektomie-Stanzen

Laminectomy Punches

Pinzas cortantes para laminectomía

Pinces emporte-pièce à laminectomie

Pinze per laminectomia

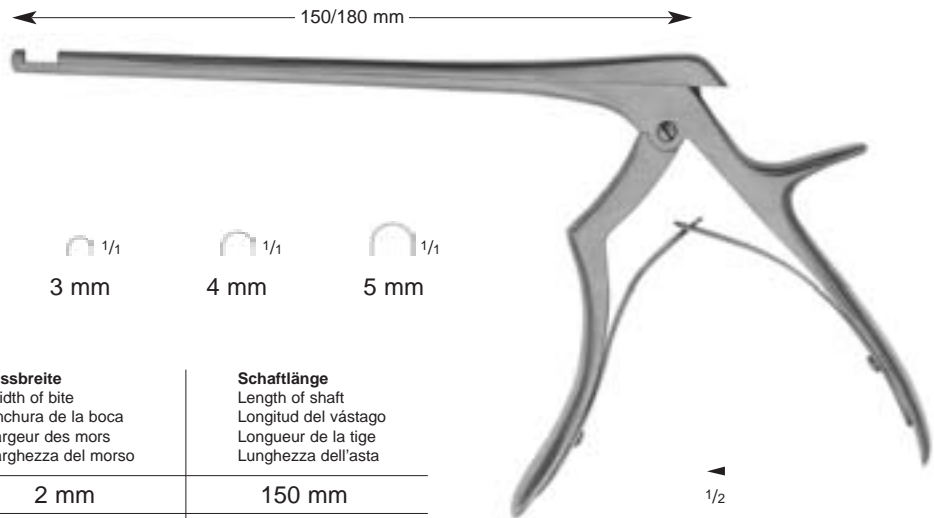

| | Bissbreite Width of bite Anchura de la boca Largeur des mors Larghezza del morso | Schaftlänge Length of shaft Longitud del vástago Longueur de la tige Lunghezza dell'asta |
|------------------|---|---|
| 45-1100 | 2 mm | 150 mm |
| 45-1101 | 3 mm | 150 mm |
| 45-1102 | 4 mm | 150 mm |
| 45-1103 | 5 mm | 150 mm |
| 45-1130 | 2 mm | 180 mm |
| ▶ 45-1131 | 3 mm | 180 mm |
| 45-1132 | 4 mm | 180 mm |
| 45-1133 | 5 mm | 180 mm |

FERRIS-SMITH-KERRISON
45-1100
- 45-1133

nach oben schneidend 90°
upwards cutting 90°
cortante hacia arriba 90°
coupant vers le haut 90°
taglio a 90° verso l'alto

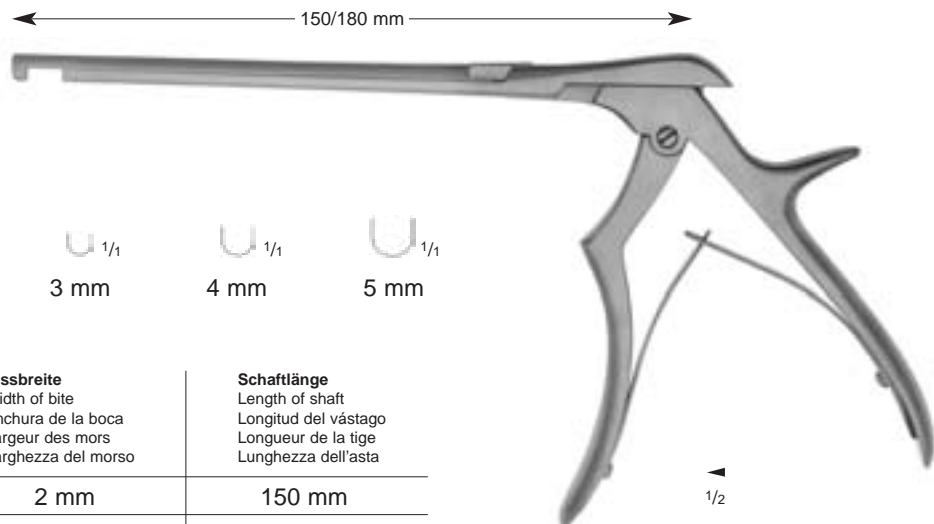

| | Bissbreite Width of bite Anchura de la boca Largeur des mors Larghezza del morso | Schaftlänge Length of shaft Longitud del vástago Longueur de la tige Lunghezza dell'asta |
|------------------|---|---|
| 45-1105 | 2 mm | 150 mm |
| 45-1106 | 3 mm | 150 mm |
| 45-1107 | 4 mm | 150 mm |
| 45-1108 | 5 mm | 150 mm |
| 45-1135 | 2 mm | 180 mm |
| ▶ 45-1136 | 3 mm | 180 mm |
| 45-1137 | 4 mm | 180 mm |
| 45-1138 | 5 mm | 180 mm |

FERRIS-SMITH-KERRISON
45-1105
- 45-1138

nach unten schneidend 90°
downwards cutting 90°
cortante hacia abajo 90°
coupant vers le bas 90°
taglio a 90° verso il basso



Laminektomie-Stanzen



Laminectomy Punches

Pinzas cortantes para laminectomía

Pinces emporte-pièce à laminectomie

Pinze per laminectomia

← 150/180/200 mm →

 1/1
 2 mm
  1/1
 3 mm
  1/1
 4 mm
  1/1
 5 mm

| | Bissbreite Width of bite Anchura de la boca Largeur des mors Larghezza del morso | Schaftlänge Length of shaft Longitud del vástago Longueur de la tige Lunghezza dell'asta |
|-----------|---|---|
| 45-1110 | 2 mm | 150 mm |
| 45-1111 | 3 mm | 150 mm |
| 45-1112 | 4 mm | 150 mm |
| 45-1113 | 5 mm | 150 mm |
| 45-1140 | 2 mm | 180 mm |
| ▶ 45-1141 | 3 mm | 180 mm |
| 45-1142 | 4 mm | 180 mm |
| 45-1143 | 5 mm | 180 mm |
| 45-1170 | 2 mm | 200 mm |
| 45-1171 | 3 mm | 200 mm |
| 45-1172 | 4 mm | 200 mm |
| 45-1173 | 5 mm | 200 mm |

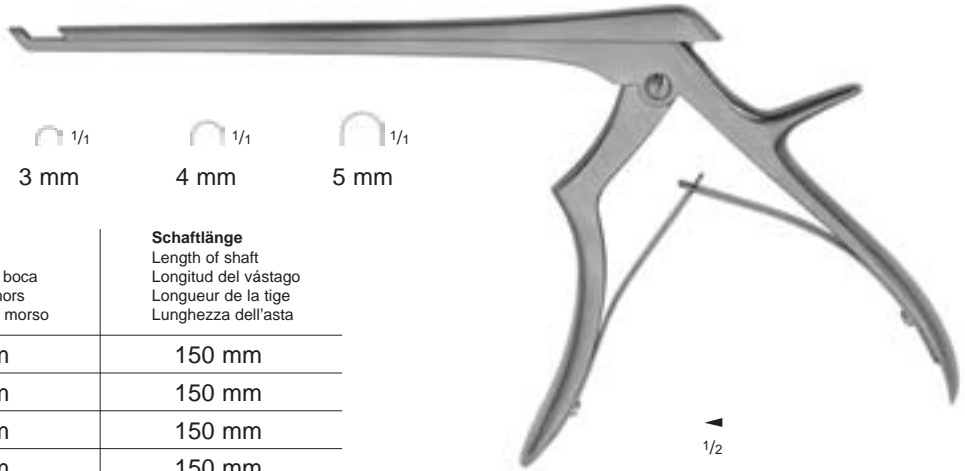



FERRIS-SMITH-KERRISON

45-1110

- **45-1173**

nach oben schneidend 130°
upwards cutting 130°
cortante hacia arriba 130°
coupant vers le haut 130°
taglio a 130° verso l'alto

← 150/200 mm →

 1/1
 3 mm
  1/1
 5 mm

| | Bissbreite Width of bite Anchura de la boca Largeur des mors Larghezza del morso | Schaftlänge Length of shaft Longitud del vástago Longueur de la tige Lunghezza dell'asta |
|-----------|---|---|
| 45-0743 | 3 mm | 150 mm |
| 45-0745 | 5 mm | 150 mm |
| ▶ 45-1743 | 3 mm | 200 mm |
| 45-1745 | 5 mm | 200 mm |

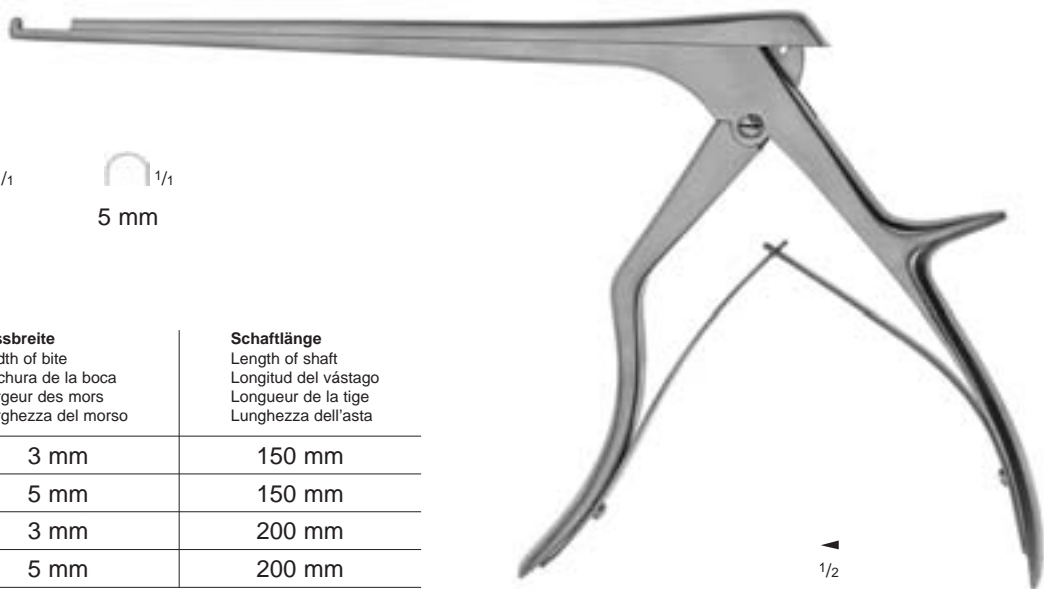

LOVE-KERRISON (COLCLOUGH)

45-0743

- **45-1745**

nach oben schneidend 90°
upwards cutting 90°
cortante hacia arriba 90°
coupant vers le haut 90°
taglio a 90° verso l'alto

Laminektomie-Stanzen

Laminectomy Punches

Pinzas cortantes para laminectomía

Pinces emporte-pièce à laminectomie

Pinze per laminectomia



← 150/200 mm →

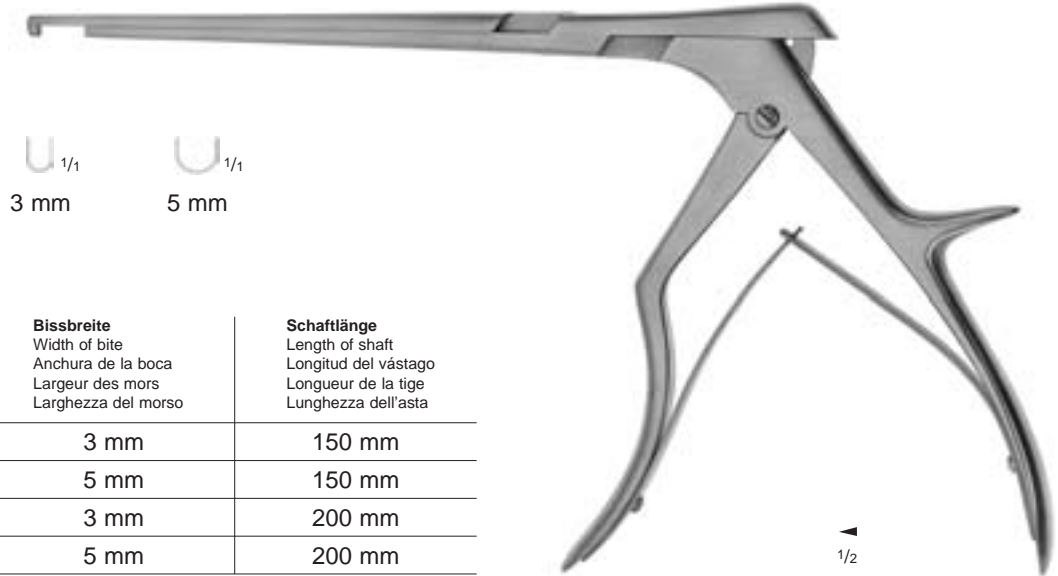

U^{1/1} 3 mm U^{1/1} 5 mm

| | Bissbreite Width of bite Anchura de la boca Largeur des mors Larghezza del morso | Schaftlänge Length of shaft Longitud del vástago Longueur de la tige Lunghezza dell'asta |
|------------------|---|---|
| 45-0753 | 3 mm | 150 mm |
| 45-0755 | 5 mm | 150 mm |
| ▶ 45-1753 | 3 mm | 200 mm |
| 45-1755 | 5 mm | 200 mm |

LOVE-KERRISON (COLCLOUGH)

45-0753

- **45-1755**

nach unten schneidend 90°
downwards cutting 90°
cortante hacia abajo 90°
coupant vers le bas 90°
taglio a 90° verso il basso

← 150/200 mm →

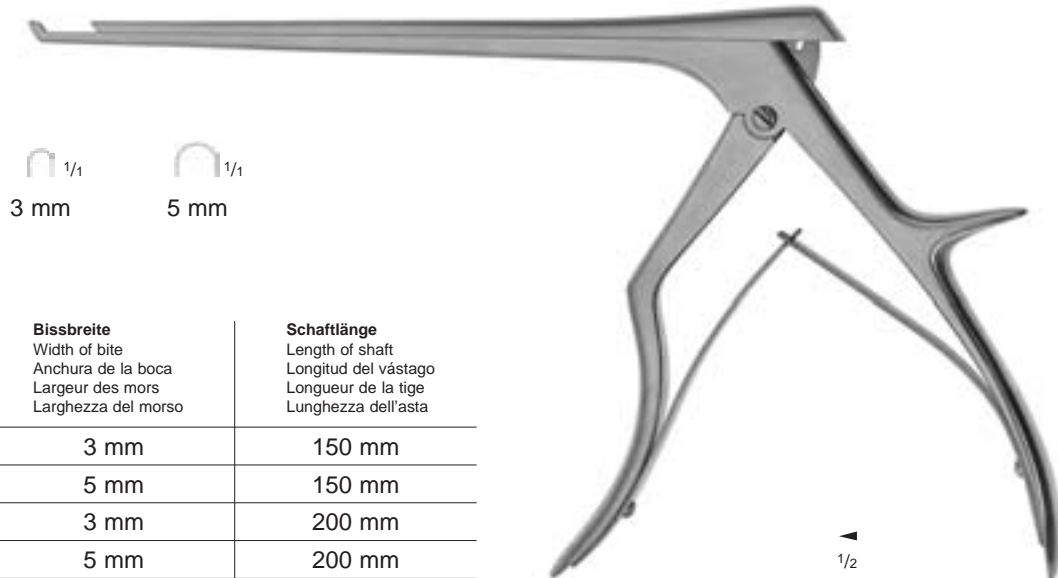

U^{1/1} 3 mm U^{1/1} 5 mm

| | Bissbreite Width of bite Anchura de la boca Largeur des mors Larghezza del morso | Schaftlänge Length of shaft Longitud del vástago Longueur de la tige Lunghezza dell'asta |
|------------------|---|---|
| 45-0763 | 3 mm | 150 mm |
| 45-0765 | 5 mm | 150 mm |
| ▶ 45-1763 | 3 mm | 200 mm |
| 45-1765 | 5 mm | 200 mm |

LOVE-KERRISON (COLCLOUGH)

45-0763

- **45-1765**

nach oben schneidend 130°
upwards cutting 130°
cortante hacia arriba 130°
coupant vers le haut 130°
taglio a 130° verso l'alto



Laminektomie-Stanzen

Laminectomy Punches

Pinzas cortantes para laminectomía

Pinces emporte-pièce à laminectomie

Pinze per laminectomia

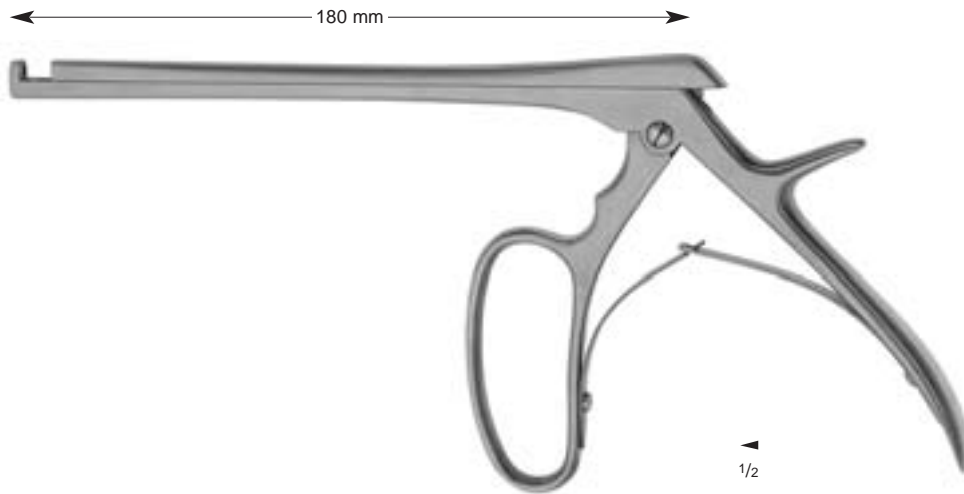

 1/1
45-0806
3 mm

 1/1
▶ **45-0807**
5 mm

FERRIS-SMITH-KERRISON
45-0806
- **45-0807**

nach oben schneidend 90°
upwards cutting 90°
cortante hacia arriba 90°
coupant vers le haut 90°
taglio a 90° verso l'alto



 1/1
45-0814
3 mm

 1/1
45-0817
5 mm

FERRIS-SMITH-KERRISON
45-0814
- **45-0817**

nach unten schneidend 90°
downwards cutting 90°
cortante hacia abajo 90°
coupant vers le bas 90°
taglio a 90° verso il basso



 1/1
45-0812
3 mm

 1/1
45-0815
5 mm

FERRIS-SMITH-KERRISON
45-0812
- **45-0815**

nach oben schneidend 130°
upwards cutting 130°
cortante hacia arriba 130°
coupant vers le haut 130°
taglio a 130° verso l'alto

Laminektomie-Zangen

Laminectomy Rongeurs

Pinzas cortantes para laminectomía

Pinces emporte-pièces à laminectomie

Pinze per laminectomia

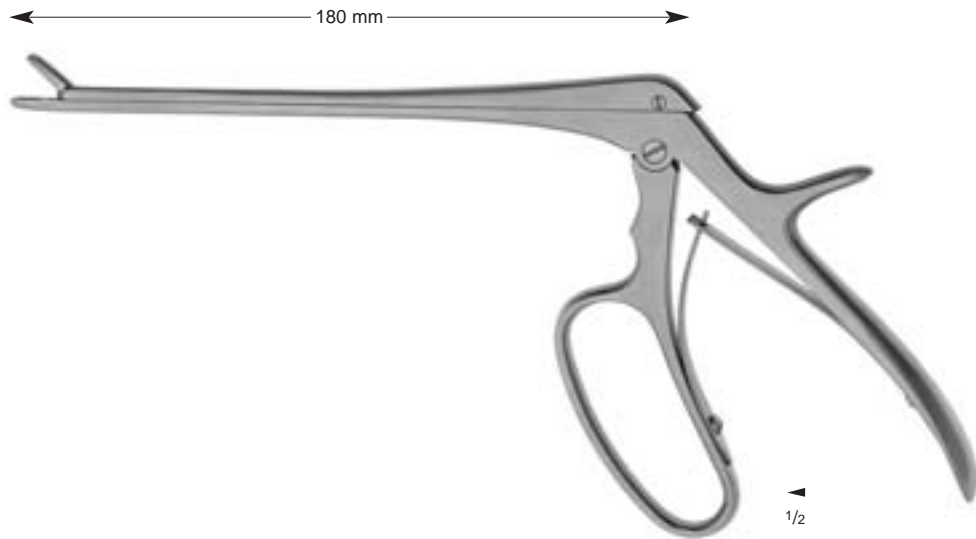

FERRIS-SMITH-CUSHING

45-0852

- **45-0854**

gerade
straight
recta
droits
retta



45-0852
2 x 10 mm



► **45-0853**
3 x 10 mm



45-0854
4 x 10 mm



FERRIS-SMITH-CUSHING

45-0862

- **45-0864**

aufgebogen
curved on flat
curva hacia arriba
courbure vers le haut
curva verso l'alto



45-0862
2 x 10 mm



45-0863
3 x 10 mm



45-0864
4 x 10 mm



FERRIS-SMITH-CUSHING

45-0872

- **45-0874**

abwärts gebogen
curved down
curva hacia abajo
courbure vers le bas
curva verso il basso



45-0872
2 x 10 mm



► **45-0873**
3 x 10 mm



45-0874
4 x 10 mm



Laminektomie-Zangen

Laminectomy Rongeurs

Pinzas cortantes para laminectomía

Pinces emporte-pièces à laminectomie

Pinze per laminectomia

120 mm



72-0212
2,5 x 5 mm



▶ **72-0222**
3,6 x 8 mm



72-0242
4,8 x 12 mm

WEIL-BLAKESLEY
72-0212
- **72-0242**

gerade
straight
recta
droits
retta

1/2

110 mm



72-0214
2,5 x 5 mm



▶ **72-0224**
3,6 x 8 mm



72-0244
4,8 x 12 mm

WEIL-BLAKESLEY
72-0214
- **72-0244**

aufgebogen
curved on flat
curva hacia arriba
courbure vers le haut
curva verso l'alto

1/2

120 mm



3 x 10 mm

1/2

TAKAHASHI
72-0202
3 x 10 mm

gerade
straight
recta
droits
retta

115 mm



3 x 10 mm

1/2

TAKAHASHI
72-0204
3 x 10 mm

aufgebogen
curved on flat
curva hacia arriba
courbure vers le haut
curva verso l'alto

Laminektomie-Zangen

Laminectomy Rongeurs

Pinzas cortantes para laminectomía

Pinces emporte-pièces à laminectomie

Pinze per laminectomia

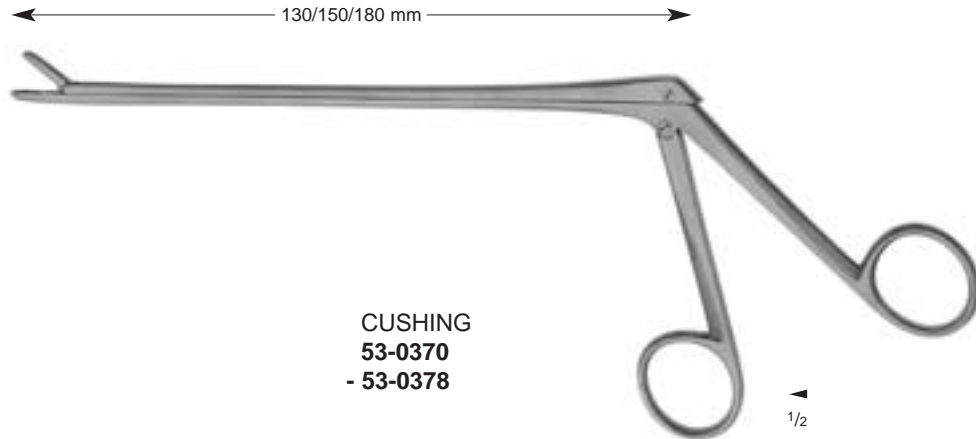

CUSHING
53-0370
- 53-0378



2 x 10 mm

| | Maulgröße Size of jaw Anchura de la boca Largeur des mors Larghezza del morso | Schaftlänge Length of shaft Longitud del vástago Longueur de la tige Lunghezza dell'asta |
|-----------|---|--|
| 53-0370 | 2 x 10 mm | 130 mm |
| 53-0373 | 2 x 10 mm | 150 mm |
| ▶ 53-0375 | 2 x 10 mm | 180 mm |

gerade
straight
recta
droits
retta



2 x 10 mm

| | Maulgröße Size of jaw Anchura de la boca Largeur des mors Larghezza del morso | Schaftlänge Length of shaft Longitud del vástago Longueur de la tige Lunghezza dell'asta |
|---------|---|--|
| 53-0371 | 2 x 10 mm | 130 mm |
| 53-0374 | 2 x 10 mm | 150 mm |
| 53-0376 | 2 x 10 mm | 180 mm |

aufgebogen
curved on flat
curva hacia arriba
courbure vers le haut
curva verso l'alto



2 x 10 mm

| | Maulgröße Size of jaw Anchura de la boca Largeur des mors Larghezza del morso | Schaftlänge Length of shaft Longitud del vástago Longueur de la tige Lunghezza dell'asta |
|---------|---|--|
| 53-0372 | 2 x 10 mm | 130 mm |
| 53-0378 | 2 x 10 mm | 150 mm |
| 53-0377 | 2 x 10 mm | 180 mm |

abwärts gebogen
curved down
curva hacia abajo
courbure vers le bas
curva verso il basso



Laminektomie-Zangen

Laminectomy Rongeurs

Pinzas cortantes para laminectomía

Pinces emporte-pièces à laminectomie

Pinze per laminectomia



LOVE-GRUENWALD
53-0400
- 53-0408



1/1
3 x 10 mm

| | Maulgröße Size of jaw Anchura de la boca Largeur des mors Larghezza del morso | Schaftlänge Length of shaft Longitud del vástago Longueur de la tige Lunghezza dell'asta |
|-----------|---|--|
| 53-0400 | 3 x 10 mm | 130 mm |
| 53-0403 | 3 x 10 mm | 150 mm |
| ▶ 53-0405 | 3 x 10 mm | 180 mm |

gerade
straight
recta
droits
retta



1/1
3 x 10 mm

| | Maulgröße Size of jaw Anchura de la boca Largeur des mors Larghezza del morso | Schaftlänge Length of shaft Longitud del vástago Longueur de la tige Lunghezza dell'asta |
|---------|---|--|
| 53-0401 | 3 x 10 mm | 130 mm |
| 53-0404 | 3 x 10 mm | 150 mm |
| 53-0406 | 3 x 10 mm | 180 mm |

aufgebogen
curved on flat
curva hacia arriba
courbure vers le haut
curva verso l'alto



1/1
3 x 10 mm

| | Maulgröße Size of jaw Anchura de la boca Largeur des mors Larghezza del morso | Schaftlänge Length of shaft Longitud del vástago Longueur de la tige Lunghezza dell'asta |
|---------|---|--|
| 53-0402 | 3 x 10 mm | 130 mm |
| 53-0408 | 3 x 10 mm | 150 mm |
| 53-0407 | 3 x 10 mm | 180 mm |

abwärts gebogen
curved down
curva hacia abajo
courbure vers le bas
curva verso il basso

Laminektomie-Zangen

Laminectomy Rongeurs

Pinzas cortantes para laminectomía

Pinces emporte-pièces à laminectomie

Pinze per laminectomia

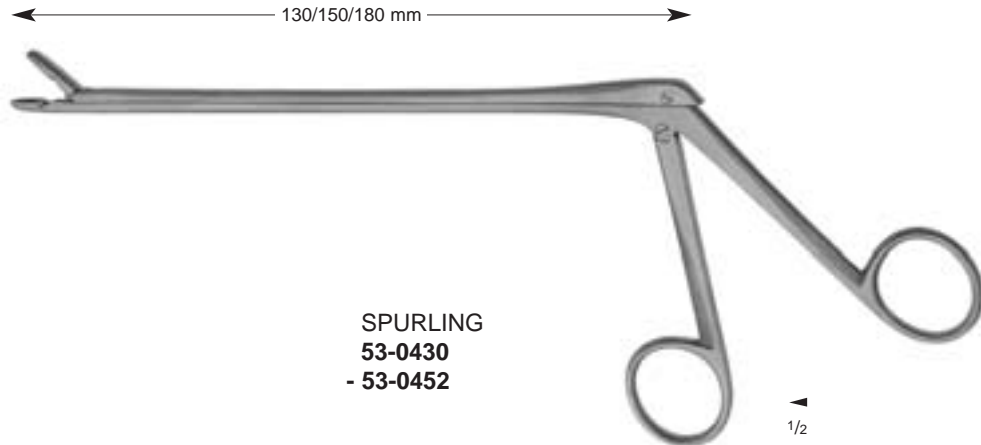

SPURLING
53-0430
- 53-0452

1/2



1/1

4 x 10 mm

| | Maulgröße Size of jaw Anchura de la boca Largeur des mors Larghezza del morso | Schaftlänge Length of shaft Longitud del vástago Longueur de la tige Lunghezza dell'asta |
|-----------|---|--|
| 53-0430 | 4 x 10 mm | 130 mm |
| 53-0450 | 4 x 10 mm | 150 mm |
| ▶ 53-0435 | 4 x 10 mm | 180 mm |

gerade
straight
recta
droits
retta



1/1

4 x 10 mm

| | Maulgröße Size of jaw Anchura de la boca Largeur des mors Larghezza del morso | Schaftlänge Length of shaft Longitud del vástago Longueur de la tige Lunghezza dell'asta |
|---------|---|--|
| 53-0431 | 4 x 10 mm | 130 mm |
| 53-0451 | 4 x 10 mm | 150 mm |
| 53-0436 | 4 x 10 mm | 180 mm |

aufgebogen
curved on flat
curva hacia arriba
courbure vers le haut
curva verso l'alto



1/1

4 x 10 mm

| | Maulgröße Size of jaw Anchura de la boca Largeur des mors Larghezza del morso | Schaftlänge Length of shaft Longitud del vástago Longueur de la tige Lunghezza dell'asta |
|---------|---|--|
| 53-0432 | 4 x 10 mm | 130 mm |
| 53-0452 | 4 x 10 mm | 150 mm |
| 53-0437 | 4 x 10 mm | 180 mm |

abwärts gebogen
curved down
curva hacia abajo
courbure vers le bas
curva verso il basso



Laminektomie-Zangen

Laminectomy Rongeurs

Pinzas cortantes para laminectomía

Pinces emporte-pièces à laminectomie

Pinze per laminectomia

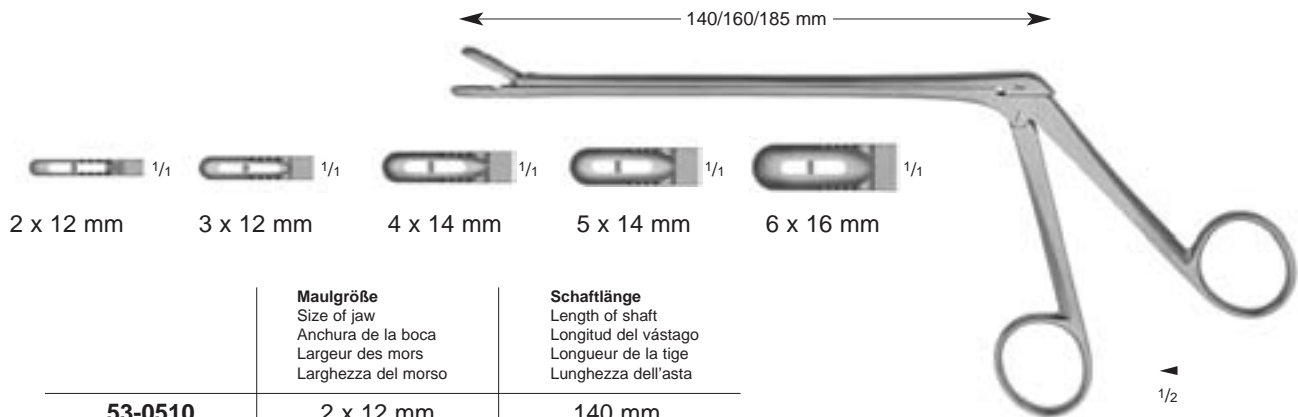

| | Maulgröße Size of jaw Anchura de la boca Largeur des mors Larghezza del morso | Schaftlänge Length of shaft Longitud del vástago Longueur de la tige Lunghezza dell'asta |
|-----------|---|--|
| 53-0510 | 2 x 12 mm | 140 mm |
| 53-0512 | 3 x 12 mm | 140 mm |
| 53-0514 | 4 x 14 mm | 140 mm |
| 53-0516 | 5 x 14 mm | 140 mm |
| 53-0518 | 6 x 16 mm | 140 mm |
| 53-0520 | 2 x 12 mm | 160 mm |
| 53-0522 | 3 x 12 mm | 160 mm |
| ▶ 53-0524 | 4 x 14 mm | 160 mm |
| 53-0526 | 5 x 14 mm | 160 mm |
| 53-0528 | 6 x 16 mm | 160 mm |
| 53-0530 | 2 x 12 mm | 185 mm |
| 53-0532 | 3 x 12 mm | 185 mm |
| 53-0534 | 4 x 14 mm | 185 mm |
| 53-0536 | 5 x 14 mm | 185 mm |
| 53-0538 | 6 x 16 mm | 185 mm |

CASPAR
53-0510
- 53-0538

gerade
straight
recta
droits
retta

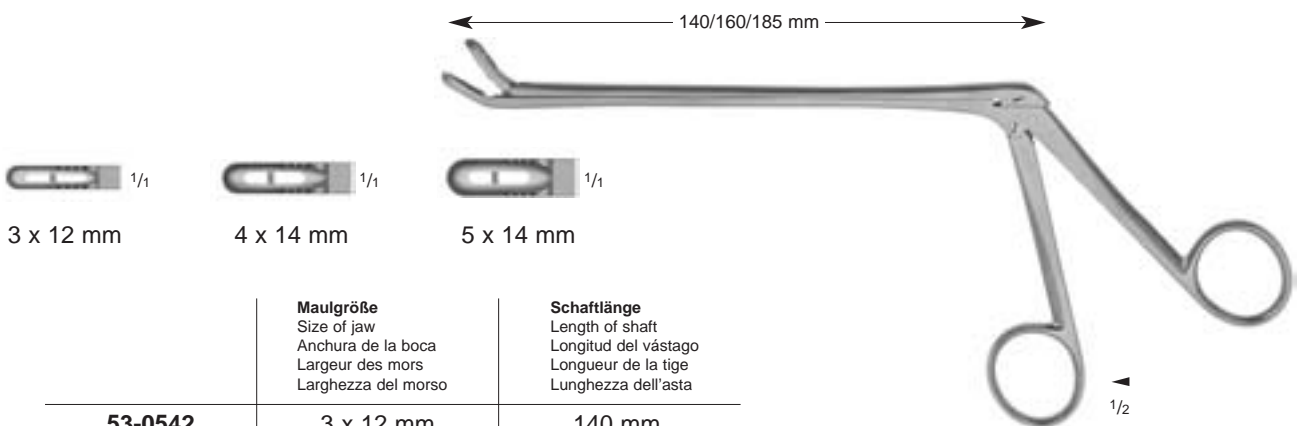

| | Maulgröße Size of jaw Anchura de la boca Largeur des mors Larghezza del morso | Schaftlänge Length of shaft Longitud del vástago Longueur de la tige Lunghezza dell'asta |
|-----------|---|--|
| 53-0542 | 3 x 12 mm | 140 mm |
| 53-0544 | 4 x 14 mm | 140 mm |
| 53-0546 | 5 x 14 mm | 140 mm |
| 53-0552 | 3 x 12 mm | 160 mm |
| ▶ 53-0554 | 4 x 14 mm | 160 mm |
| 53-0556 | 5 x 14 mm | 160 mm |
| 53-0562 | 3 x 12 mm | 185 mm |
| 53-0564 | 4 x 14 mm | 185 mm |
| 53-0566 | 5 x 14 mm | 185 mm |

CASPAR
53-0542
- 53-0566

aufgebogen
curved on flat
curva hacia arriba
courbure vers le haut
curva verso l'alto

Laminektomie-Zangen

Laminectomy Rongeurs

Pinzas cortantes para laminectomía

Pinces emporte-pièces à laminectomie

Pinze per laminectomia



140/160/185 mm



3 x 12 mm



4 x 14 mm

| | Maulgröße Size of jaw Anchura de la boca Largeur des mors Larghezza del morso | Schaftlänge Length of shaft Longitud del vástago Longueur de la tige Lunghezza dell'asta |
|------------------|--|---|
| 53-0572 | 3 x 12 mm | 140 mm |
| 53-0574 | 4 x 14 mm | 140 mm |
| 53-0582 | 3 x 12 mm | 160 mm |
| ▶ 53-0584 | 4 x 14 mm | 160 mm |
| 53-0592 | 3 x 12 mm | 185 mm |
| 53-0594 | 4 x 14 mm | 185 mm |



CASPAR
53-0572
- 53-0594

abwärts gebogen
curved down
curva hacia abajo
courbure vers le bas
curva verso il basso

180 mm

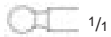

YASARGIL
57-1250
3,5 mm

Hypophysenzange
Pituitary rongeur
Pinza para hipófisis
Pince pour l'hypophyse
Pinza ipofisaria

180 mm



OLDBERG
53-0300
6 mm

Hypophysenzange
Pituitary rongeur
Pinza para hipófisis
Pince pour l'hypophyse
Pinza ipofisaria



CRAIG-KOGLER Wirbelkörper-Biopsieinstrumentarium

CRAIG-KOGLER Vertebral Biopsy Instruments

CRAIG-KOGLER Juego para la biopsia vertebral

CRAIG-KOGLER Set pour la biopsie vertébrale

CRAIG-KOGLER Strumenti per biopsia vertebrale

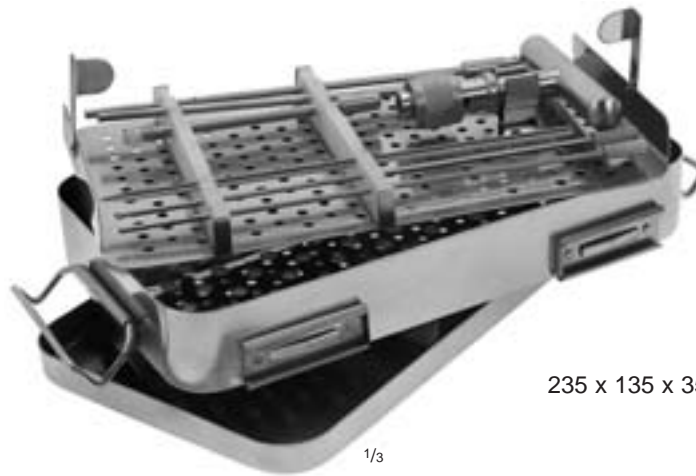

235 x 135 x 35 mm

1/3

CRAIG-KOGLER

45-0950

Wirbelkörper-Biopsieinstrumentarium, komplett, bestehend aus:

- | | |
|---------|---|
| 07-0703 | 1 Sterilisierbehälter aus 18/8 Chromnickelstahl, mit Halterungen für Kennzeichnungsschilder und mit Textil-Langzeitfilter im Boden, Deckel mit Silikon-Andrückleiste zum Fixieren der Instrumente |
| 57-1286 | 1 Sterilisierrahmen mit Silikonbank - die einzelnen Aussparungen sind der Stärke des jeweiligen Instrumentes angepaßt - und mit Halterung für Griff |
| 45-0951 | 1 Trokarhülse mit Zentimeter-Einteilung, ø 5 mm x 100 mm |
| 45-0953 | 1 halbstumpfer Trokar, ø 4 mm x 190 mm |
| 45-0955 | 1 Punktionstrephine für Knochen, mit gezahnter Schneide, ø 4 mm x 190 mm |
| 45-0956 | 1 Punktionstrephine für Weichteile, mit glatter Schneide, ø 4 mm x 190 mm |
| 45-0957 | 1 Handgriff mit Kugelschnellverschluss zum Einführen und zur Extraktion von Punktionstrepheinen |
| 45-0958 | 1 Doppelkralle zur Extraktionshilfe von Weichteilen, ø 2,5 mm x 210 mm |
| 45-0959 | 1 stumpfer Mandrin zum Ausstoßen von Gewebeproben, ø 2,5 mm x 210 mm |

Set of vertebral biopsy instruments, complete, consisting of:

- | | |
|---------|--|
| 07-0703 | 1 Sterilizing case of 18/8 nickel chromium steel, with mounts for labels and long-life fabric filter in the base, silicone strips in lid for fixation of instruments |
| 57-1286 | 1 Sterilizing tray with silicone bed (the recesses are of the same width as the individual instruments) and bracket for a handle |
| 45-0951 | 1 Trocar cannula with centimetre scale diam. 5 mm x 100 mm |
| 45-0953 | 1 Semi-blunt trocar diam. 4 mm x 190 mm |
| 45-0955 | 1 Trephine for bone, with serrated cutting edge diam. 4 mm x 190 mm |
| 45-0956 | 1 Trephine for soft tissue, with smooth cutting edge diam. 4 mm x 190 mm |
| 45-0957 | 1 Handle with spherical quick-release mechanism for inserting and withdrawing the trephines |
| 45-0958 | 1 Double-ended retractor for extracting soft tissue diam. 2.5 mm x 210 mm |
| 45-0959 | 1 Blunt obturator for ejecting tissue samples diam. 2.5 mm x 210 mm |

Juego para la biopsia vertebral, completo, compuesto de:

- | | |
|---------|---|
| 07-0703 | 1 Caja de esterilización de acero 18/8, con porta-placas de identificación y con filtro de tejido de larga duración al fondo, tapa con tira de silicona para fijar los instrumentos |
| 57-1286 | 1 Dispositivo de esterilización con armadura de silicona para sujetar los instrumentos, sujetador con mango |
| 45-0951 | 1 Cánula de trocar con escala graduada en centímetros, ø 5 mm x 100 mm |
| 45-0953 | 1 Trocar semi-romo, ø 4 mm x 190 mm |
| 45-0955 | 1 Trépano de punción para huesos, con filo dentado, ø 4 mm x 190 mm |
| 45-0956 | 1 Trépano de punción para tejido blando, con filo liso, ø 4 mm x 190 mm |
| 45-0957 | 1 Mango con cierre esférico rápido para introducir y extraer los trépanos de punción |
| 45-0958 | 1 Doble-garra para extraer tejido blando, ø 2,5 mm x 210 mm |
| 45-0959 | 1 Obturador para sacar pruebas de tejido, ø 2,5 mm x 210 mm |

Set pour la biopsie vertébrale, complet, composé de:

- | | |
|---------|---|
| 07-0703 | 1 Boîte de stérilisation d'acier chrome 18/8, avec supports pour des plaques d'identification et avec des filtres de longue durée au fond, couvercle avec des bandes en silicone pour fixer les instruments |
| 57-1286 | 1 Cadre de stérilisation avec bandes en silicone - avec mesures ajustées aux dimensions des instruments, et avec support pour le manche |
| 45-0951 | 1 Canule de trocar graduée en cm, ø 5 mm x 100 mm |
| 45-0953 | 1 Trocart semi-mou, ø 4 mm x 190 mm |
| 45-0955 | 1 Tréphine de ponction pour os, avec tranchant dentelé, ø 4 mm x 190 mm |
| 45-0956 | 1 Tréphine de ponction pour tissu mou, avec tranchant lisse, ø 4 mm x 190 mm |
| 45-0957 | 1 Manche avec mécanisme à billes pour introduire et enlever les tréphines de ponction |
| 45-0958 | 1 Double griffe pour extraction des tissus mous, ø 2,5 mm x 210 mm |
| 45-0959 | 1 Obturateur mou pour pousser les échantillons de tissu, ø 2,5 mm x 210 mm |

Set per biopsia vertebrale, completo, composto da:

- | | |
|---------|---|
| 07-0703 | 1 Cassetta sterilizzabile in acciaio inox 18/8, con porta placche di riconoscimento, filtro a lunga durata sulla base, strisce di silicone per il fissaggio degli strumenti |
| 57-1286 | 1 Dispositivo di sterilizzazione in silicone per contenere gli strumenti e supporto per il manico |
| 45-0951 | 1 Cannula per trocar con scala centimetrata ø mm. 5 x 100 |
| 45-0953 | 1 Trocar semi smusso ø mm. 4 x 190 |
| 45-0955 | 1 Trapano per osso, con taglio dentato ø mm. 4 x 190 |
| 45-0956 | 1 Trapano per tessuti molli, con taglio piatto ø mm. 4 x 190 |
| 45-0957 | 1 Manico con meccanismo sferico di pronto rilascio per inserire ed estrarre, trapani |
| 45-0958 | 1 Retrattore doppio per estrarre il tessuto molle ø mm. 2,5 x 210 |
| 45-0959 | 1 Otturatore smusso per espellere il tessuto campione ø mm. 2,5 x 210 |

CRAIG-KOGLER Wirbelkörper-Biopsieinstrumentarium

CRAIG-KOGLER Vertebral Biopsy Instruments

CRAIG-KOGLER Juego para la biopsia vertebral

CRAIG-KOGLER Set pour la biopsie vertébrale

CRAIG-KOGLER Strumenti per biopsia vertebrale



1/1

45-0951

Ø 5 mm x 100 mm

Trokarhülse mit Zentimeter-Einteilung

Trocar cannula with centimetre scale

Cánula de trocar con escala graduada en centímetros

Canule de trocart graduée en cm

Cannula per trocar con scala centimetrata



1/2



1/1

45-0953

Ø 4 mm x 190 mm

halbstumpfer Trokar

Semi-blunt trocar
Trocar semi-romo
Trocart semi-mou
Trequarti semi smusso



1/2



1/1

45-0955

Ø 4 mm x 190 mm

Punktionstrephine für Knochen, mit gezahnter Schneide

Trephine for bone, with serrated cutting edge

Trépano de punción para huesos, con filo dentado

Tréphine de ponction pour os, avec tranchant dentellé

Trapano per osso, con tagliente dentato



1/2



1/1

45-0956

Ø 4 mm x 190 mm

Punktionstrephine für Weichteile, mit glatter Schneide

Trephine for soft tissue, with smooth cutting edge

Trépano de punción para tejido blando, con filo liso

Tréphine de ponction pour tissu mou, avec tranchant lisse

Trapano per tessuto molle, con taglio piatto



1/2

45-0957

Handgriff mit Kugelschnellverschluss zum Einführen und zur Extraktion von Punktionstrephinen

Handle with spherical quick-release mechanism for inserting and withdrawing the trephines

Mango con cierre esférico rápido para introducir y extraer los trépanos de punción

Manche avec mécanisme à billes pour introduire et enlever les tréphines de ponction

Manico con meccanismo sferico di sgancio per inserire ed estrarre, trapani



1/2



1/1

45-0958

Ø 2,5 mm x 210 mm

Doppelkralle zur Extraktionshilfe von Weichteilen

Double-ended retractor for extracting soft tissue

Doble-garra para extraer tejido blando

Double griffe pour extraction des tissus moux

Retratore doppio per estrarre il tessuto molle



1/2



1/1

45-0959

Ø 2,5 mm x 210 mm

stumpfer Mandrin zum Ausstoßen von Gewebeproben

Blunt obturator for ejecting tissue samples

Obturador para sacar pruebas de tejido

Obtuteur mou pour pousser les échantillons de tissu

Otturatore smusso per espellere il tessuto campione



1/2



Notizen

Notes

Notas

Notes

Note



LAWNTON
Medizintechnik



Tracheotomie
Tracheotomy
Traqueotomía
Trachéotomie
Tracheotomia



Instrumente für Tracheotomie
Instruments for Tracheotomy
Instrumentos para traqueotomía
Instruments pour trachéotomie
Strumenti per tracheotomia



| | | |
|-----------------------------------|--------|-------------------|
| Trachealhäkchen | Seite | 217, 219-220, 226 |
| Trachea Retractors | Page | 217, 219-220, 226 |
| Separadores para la tráquea | Página | 217, 219-220, 226 |
| Ecarteurs pour trachéotomie | Page | 217, 219-220, 226 |
| Uncini tracheali | Pagina | 217, 219-220, 226 |



| | | |
|----------------------------|--------|-----|
| Kropfwundhaken | Seite | 224 |
| Goitre Retractor | Page | 224 |
| Separador para bocio | Página | 224 |
| Ecarteur à goitre | Page | 224 |
| Uncino per gozzo | Pagina | 224 |



| | | |
|---|--------|-----|
| Wundspreizer, selbsthaltend | Seite | 270 |
| Self-Retaining Retractors | Page | 270 |
| Separadores con retenida automática | Página | 270 |
| Ecarteurs autostatiques | Page | 270 |
| Divaricatori autostatici | Pagina | 270 |



| | | |
|-----------------------------|--------|-----|
| Kropfsonden | Seite | 378 |
| Directors-Enucleators | Page | 378 |
| Sondas acanaladas | Página | 378 |
| Sondes à goitre | Page | 378 |
| Sonde per gozzo | Pagina | 378 |



| | | |
|---------------------------------|--------|-----|
| Kropffaßzange | Seite | 454 |
| Goitre Seizing Forceps | Page | 454 |
| Pinza para coger el bocio | Página | 454 |
| Pince à goitre | Page | 454 |
| Pinza per gozzo | Pagina | 454 |



Internationale Größenskala
 International Scale
 Escala internacional
 Echelle internationale
 Scala internazionale

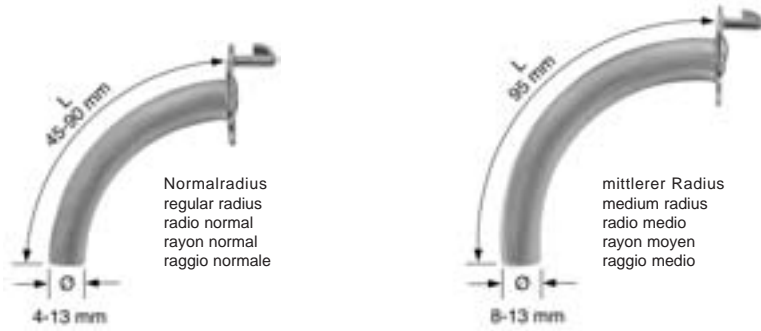

| | | | | | | | | | | |
|------|---|---|---|---|---|---|----|----|----|----|
| Fig. | 0 | 1 | 2 | 3 | 4 | 5 | 6 | 7 | 8 | 9 |
| ø mm | 4 | 5 | 6 | 7 | 8 | 9 | 10 | 11 | 12 | 13 |

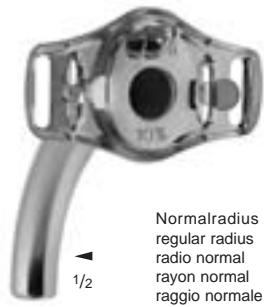

LUER

Normalradius
 regular radius
 radio normal
 rayon normal
 raggio normale

| Fig. | ø mm | L mm | Silber Silver Plata Argent Argento | Neusilber German silver Plata meneses Argent blanc Argento bianco | Rostfreier Stahl 18/8 Stainless steel 18/8 Acero inoxidable 18/8 Acier inox 18/8 Acciaio inox 18/8 |
|------|------|------|--|---|--|
| 0 | 4 | 45 | 87-0440 | 87-0450 | 87-0460 |
| 1 | 5 | 50 | 87-0441 | 87-0451 | 87-0461 |
| 2 | 6 | 55 | 87-0442 | 87-0452 | 87-0462 |
| 3 | 7 | 60 | 87-0443 | 87-0453 | 87-0463 |
| 4 | 8 | 65 | 87-0444 | 87-0454 | 87-0464 |
| 5 | 9 | 70 | 87-0445 | 87-0455 | 87-0465 |
| 6 | 10 | 75 | 87-0446 | ▶ 87-0456 | 87-0466 |
| 7 | 11 | 80 | 87-0447 | 87-0457 | 87-0467 |
| 8 | 12 | 85 | 87-0448 | 87-0458 | 87-0468 |
| 9 | 13 | 90 | 87-0449 | 87-0459 | 87-0469 |



LUER

mittlerer Radius
 medium radius
 radio medio
 rayon moyen
 raggio medio

| Fig. | ø mm | L mm | Silber Silver Plata Argent Argento |
|------|------|------|--|
| 4 | 8 | 95 | 87-0414 |
| 5 | 9 | 95 | 87-0415 |
| 6 | 10 | 95 | ▶ 87-0416 |
| 7 | 11 | 95 | 87-0417 |
| 8 | 12 | 95 | 87-0418 |
| 9 | 13 | 95 | 87-0419 |



Trachealkanülen
Trachea Tubes
Cánulas traqueales
Canules pour la trachéotomie
Cannule tracheali

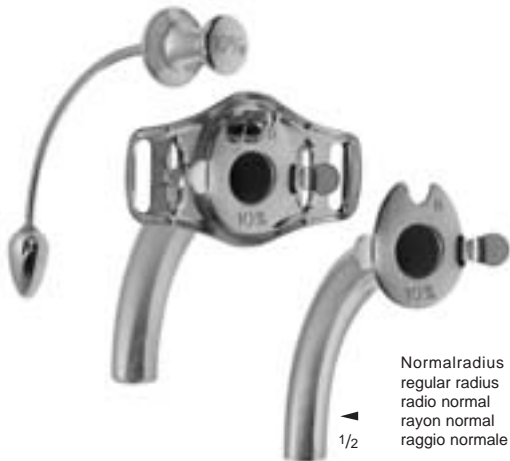

Normalradius
regular radius
radio normal
rayon normal
raggio normale

1/2

CHEVALIER-JACKSON

| Fig. | ø mm | L mm | Silber Silver Plata Argent Argento | Neusilber German silver Plata meneses Argent blanc Argento bianco | Rostfreier Stahl 18/8 Stainless steel 18/8 Acero inoxidable 18/8 Acier inox 18/8 Acciaio inox 18/8 |
|------|---------|---------|--|---|--|
| 0 | 4 | 45 | 87-0400 | 87-0420 | 87-0430 |
| 1 | 5 | 50 | 87-0401 | 87-0421 | 87-0431 |
| 2 | 6 | 55 | 87-0402 | 87-0422 | 87-0432 |
| 3 | 7 | 60 | 87-0403 | 87-0423 | 87-0433 |
| 4 | 8 | 65 | 87-0404 | 87-0424 | 87-0434 |
| 5 | 9 | 70 | 87-0405 | 87-0425 | 87-0435 |
| 6 | 10 | 75 | 87-0406 | ▶ 87-0426 | 87-0436 |
| 7 | 11 | 80 | 87-0407 | 87-0427 | 87-0437 |
| 8 | 12 | 85 | 87-0408 | 87-0428 | 87-0438 |
| 9 | 13 | 90 | 87-0409 | 87-0429 | 87-0439 |



Normalradius
regular radius
radio normal
rayon normal
raggio normale

1/2

| Fig. | ø mm | L mm | Neusilber German silver Plata meneses Argent blanc Argento bianco |
|------|---------|---------|---|
| 4 | 8 | 65 | 87-0554 |
| 5 | 9 | 70 | 87-0555 |
| 6 | 10 | 75 | ▶ 87-0556 |
| 7 | 11 | 80 | 87-0557 |
| 8 | 12 | 85 | 87-0558 |
| 9 | 13 | 90 | 87-0559 |

Ventil-Sprechkanülen mit rundem Aufsteckventil
Valve speaking tubes, with detachable round valve
Cánulas traqueales con válvula para hablar, redonda
Canules parlantes avec soupape ronde amovible
Cannule parlante con valvola rotonda mobile



Normalradius
regular radius
radio normal
rayon normal
raggio normale

| Fig. | ø mm | L mm | Silber Silver Plata Argent Argento | Neusilber German silver Plata meneses Argent blanc Argento bianco |
|------|------|------|--|---|
| 4 | 8 | 65 | 87-0564 | 87-0574 |
| 5 | 9 | 70 | 87-0565 | 87-0575 |
| 6 | 10 | 75 | 87-0566 | ▶ 87-0576 |
| 7 | 11 | 80 | 87-0567 | 87-0577 |
| 8 | 12 | 85 | 87-0568 | 87-0578 |
| 9 | 13 | 90 | 87-0569 | 87-0579 |

Ventil-Sprechkanülen, Innenrohr mit Schiebeventil

Valve speaking tubes, inner tube with sliding valve

Cánulas traqueales con válvula para hablar, cánula interior con válvula de corredera

Canules parlantes, tube intérieur avec soupape à coulisse

Cannule parlanti, tubo interno con valvola scorrevole



mittlerer Radius
medium radius
radio medio
rayon moyen
raggio medio

| Fig. | ø mm | L mm | Silber Silver Plata |
|------|------|------|---------------------------|
| 4 | 8 | 95 | 87-0584 |
| 5 | 9 | 95 | 87-0585 |
| 6 | 10 | 95 | ▶ 87-0586 |
| 7 | 11 | 95 | 87-0587 |
| 8 | 12 | 95 | 87-0588 |
| 9 | 13 | 95 | 87-0589 |

Ventil-Sprechkanülen, Innenrohr mit Schiebeventil

Valve speaking tubes, inner tube with sliding valve

Cánulas traqueales con válvula para hablar, cánula interior con válvula de corredera

Canules parlantes, tube intérieur avec soupape à coulisse

Cannule parlanti, tubo interno con valvola scorrevole

ø 12 mm



87-0650
30 cm, 12"

Reinigungsbürste für Trachealkanülen

Cleaning brush for trachea tubes

Cepillo de limpieza para cánulas traqueales

Brosse à nettoyer les canules trachéales

Spazzolino per pulire per cannule tracheali



Instrumente für Tracheotomie
 Instruments for Tracheotomy
 Instrumentos traqueotomía
 Instruments pour trachéotomie
 Strumenti per tracheotomia



UECKERMANN-DENKER
 87-0150
 - 87-0151
 11,5 cm, 4 1/2"

Not-Tracheotomietrokare mit Silberkanüle (Tracheotom)
 Cryothyreotomy trocars with silver cannula
 Trocares traqueales con cánula de plata (traqueotomo)
 Trocars pour la trachéotomie avec canule argent
 Tre quarti per tracheotomia con cannula di argento



BOSE
 87-0145
 16,5 cm, 6 1/2"

Trachealhäkchen, spitz, links
 Trachea retractor, sharp, left
 Separador para la tráquea, agudo, izquierdo
 Ecarteur pour trachéotomie, pointu, à gauche
 Uncino tracheale, acuto, sinistro



BOSE
 87-0146
 16,5 cm, 6 1/2"

Trachealhäkchen, spitz, rechts
 Trachea retractor, sharp, right
 Separador para la tráquea, agudo, derecho
 Ecarteur pour trachéotomie, pointu, à droite
 Uncino tracheale, acuto, destro



TROUSSEAU
 87-0270
 14 cm, 5 1/2"

Trachealdilatator
 Trachea dilator
 Dilatador para la tráquea
 Dilatateur pour la trachéotomie
 Dilatatore per tracheotomia



LABORDE
 87-0275
 14 cm, 5 1/2"

Trachealdilatator
 Trachea dilator
 Dilatador para la tráquea
 Dilatateur pour la trachéotomie
 Dilatatore per tracheotomia

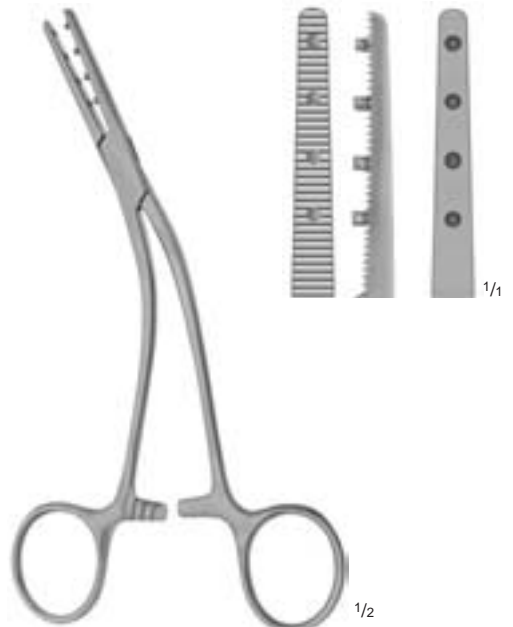

MASTIN
 12-0175
 17 cm, 6 3/4"

Muskelklemme
 Muscular clamp
 Pinza-clamp para músculos
 Pince-clamp musculaire
 Pinza muscolare

Tracheotomiebesteck
 Tracheotomy Set
 Juego para traqueotomía
 Jeu d'instruments pour trachéotomie
 Set per tracheotomia

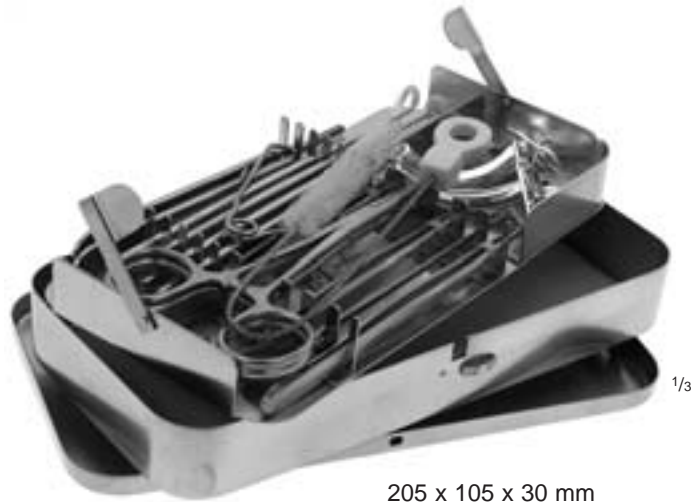

1/3

205 x 105 x 30 mm

87-1035

Tracheotomiebesteck, komplett, bestehend aus:

| | | |
|---------|---|---|
| 57-1294 | 1 | Rack |
| 07-0960 | 1 | Metalletui |
| 04-1055 | 2 | Griffe No. 4 |
| 04-1020 | 1 | Klinge Fig. 20 |
| 04-1023 | 1 | Klinge Fig. 23 |
| 06-0299 | 2 | PEAN Klemmen, 13 cm, 5 1/8" |
| 09-0116 | 1 | anat. Pinzette, 13 cm, 5 1/8" |
| 09-0156 | 2 | chir. Pinzetten, 13 cm, 5 1/8", 1x2 Zähne |
| 15-0204 | 1 | Hohlsonde, 13 cm, 5 1/8" |
| 20-0211 | 2 | Trachealhäkchen, stumpf, 17 cm, 6 3/4" |
| 21-0159 | 1 | FINSEN Wundspreizer, stumpf, 7 cm, 2 3/4" |
| 87-0145 | 1 | BOSE Trachealhäkchen, scharf, links, 16,5 cm, 6 1/2" |
| 87-0146 | 1 | BOSE Trachealhäkchen, scharf, rechts, 16,5 cm, 6 1/2" |
| 87-0453 | 1 | LUER Trachealkanüle, Fig. 3, ø 7 mm, Neusilber |
| 87-0454 | 1 | LUER Trachealkanüle, Fig. 4, ø 8 mm, Neusilber |
| 87-0650 | 1 | Reinigungsbürste, 30 cm, 12" |

Tracheotomy set, complete, consisting of:

| | | |
|---------|---|---|
| 57-1294 | 1 | Rack |
| 07-0960 | 1 | Metal case |
| 04-1055 | 2 | Handles No. 4 |
| 04-1020 | 1 | Blade fig. 20 |
| 04-1023 | 1 | Blade fig. 23 |
| 06-0299 | 2 | PEAN Artery forceps, 13 cm, 5 1/8" |
| 09-0116 | 1 | Dissecting forceps, 13 cm, 5 1/8" |
| 09-0156 | 2 | Tissue forceps, 13 cm, 5 1/8", 1x2 teeth |
| 15-0204 | 1 | Grooved director, 13 cm, 5 1/8" |
| 20-0211 | 2 | Trachea retractors, blunt, 17 cm, 6 3/4" |
| 21-0159 | 1 | FINSEN retractor, blunt, 7 cm, 2 3/4" |
| 87-0145 | 1 | BOSE trachea retractor, sharp, left, 16,5 cm, 6 1/2" |
| 87-0146 | 1 | BOSE trachea retractor, sharp, right, 16,5 cm, 6 1/2" |
| 87-0453 | 1 | LUER trachea tube, fig. 3, ø 7 mm, German silver |
| 87-0454 | 1 | LUER trachea tube, fig. 4, ø 8 mm, German silver |
| 87-0650 | 1 | Cleaning brush, 30 cm, 12" |

Juego para traqueotomía, completo, compuesto de:

| | | |
|---------|---|--|
| 57-1294 | 1 | Depositivo |
| 07-0960 | 1 | Caja de esterilización |
| 04-1055 | 2 | Mangos No. 4 |
| 04-1020 | 1 | Hoja fig. 20 |
| 04-1023 | 1 | Hoja fig. 23 |
| 06-0299 | 2 | PEAN pinzas hemostáticas, 13 cm, 5 1/8" |
| 09-0116 | 1 | Pinza de disección, 13 cm, 5 1/8" |
| 09-0156 | 2 | Pinzas quirúrgicas, con 1x2 dientes, 13 cm, 5 1/8" |
| 15-0204 | 1 | Sonda acanalada, 13 cm, 5 1/8" |
| 20-0211 | 2 | Separadores traqueales, romos, 17 cm, 6 3/4" |
| 21-0159 | 1 | FINSEN Separador traqueal, romo, 7 cm, 2 3/4" |
| 87-0145 | 1 | BOSE Separador traqueal, agudo, izquierdo, 16,5 cm, 6 1/2" |
| 87-0146 | 1 | BOSE Separador traqueal, agudo, derecho, 16,5 cm, 6 1/2" |
| 87-0453 | 1 | LUER Cánula traqueal, fig. 3, ø 7 mm, de plata meneses |
| 87-0454 | 1 | LUER Cánula traqueal, fig. 4, ø 8 mm, de plata meneses |
| 87-0650 | 1 | Cepillo de limpieza, 30 cm, 12" |

Jeu d'instruments pour trachéotomie, complet, composé de:

| | | |
|---------|---|--|
| 57-1294 | 1 | Chevalet |
| 07-0960 | 1 | Bôte métal |
| 04-1055 | 2 | Manche de bistouri No. 4 |
| 04-1020 | 1 | Lame fig. 20 |
| 04-1023 | 1 | Lame fig. 23 |
| 06-0299 | 2 | Pinces hémostatiques PEAN, 13 cm, 5 1/8" |
| 09-0116 | 1 | Pince à dissection, 13 cm, 5 1/8" |
| 09-0156 | 2 | Pinces à griffes, 13 cm, 5 1/8", 1x2 dents |
| 15-0204 | 1 | Sonde cannelée, 13 cm, 5 1/8" |
| 20-0211 | 2 | Ecarteurs pour trachéotomie, moux, 17 cm, 6 3/4" |
| 21-0159 | 1 | FINSEN écarteur, mou, 7 cm, 2 3/4" |
| 87-0145 | 1 | BOSE écarteur pour trachéotomie, pointu, à gauche, 16,5 cm, 6 1/2" |
| 87-0146 | 1 | BOSE écarteur pour trachéotomie, pointu, à droite, 16,5 cm, 6 1/2" |
| 87-0453 | 1 | LUER canule trachéale, fig. 3, ø 7 mm, argent blanc |
| 87-0454 | 1 | LUER canule trachéale, fig. 4, ø 8 mm, argent blanc |
| 87-0650 | 1 | Brosse à nettoyer, 30 cm, 12" |

Set per tracheotomia, completo, composto da:

| | | |
|---------|---|---|
| 57-1294 | 1 | Supporto |
| 07-0960 | 1 | Scatola in metallo |
| 04-1055 | 2 | Manici per bisturi No. 4 |
| 04-1020 | 1 | Lama fig. 20 |
| 04-1023 | 1 | Lama fig. 23 |
| 06-0299 | 2 | Pinze emostatiche PEAN, 13 cm, 5 1/8" |
| 09-0116 | 1 | Pinza per dissezione, 13 cm, 5 1/8" |
| 09-0156 | 2 | Pinze per dissezione con denti 1x2, 13 cm, 5 1/8" |
| 15-0204 | 1 | Sonda scanalata, 13 cm, 5 1/8" |
| 20-0211 | 2 | Uncini tracheali, smussi, 17 cm, 6 3/4" |
| 21-0159 | 1 | Divaricatore FINSEN, smusso, 7 cm, 2 3/4" |
| 87-0145 | 1 | Uncino tracheale BOSE, acuto, sinistro, 16,5 cm, 6 1/2" |
| 87-0146 | 1 | Uncino tracheale BOSE, acuto, destro, 16,5 cm, 6 1/2" |
| 87-0453 | 1 | Cannula tracheale LUER, fig. 3, ø 7 mm, argento bianco |
| 87-0454 | 1 | Cannula tracheale LUER, fig. 4, ø 8 mm, argento bianco |
| 87-0650 | 1 | Spazzolino per pulire, 30 cm, 12" |



Tracheotomiebesteck
Tracheotomy Set
Juego para traqueotomía
Jeu d'instruments pour trachéotomie
Set per tracheotomia

205 x 105 x 42 mm

57-1296

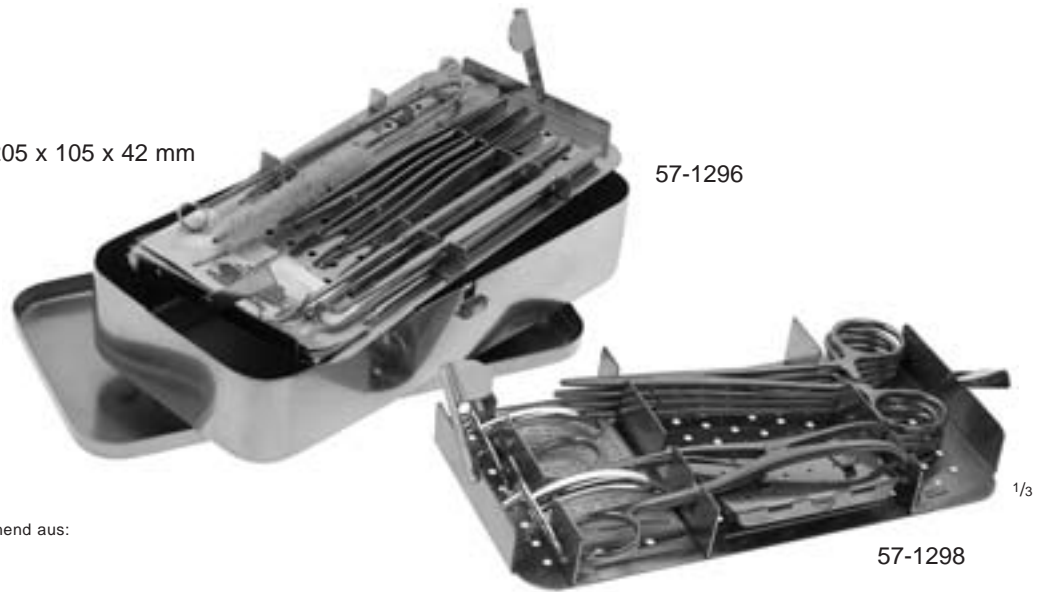

1/3

57-1298

87-1040

Tracheotomiebesteck, komplett, bestehend aus:

| | |
|---------|---|
| 57-1296 | 1 Rack |
| 57-1298 | 1 Rack |
| 07-0962 | 1 Metalletui |
| 04-1055 | 1 Griff No. 4 |
| 04-1020 | 1 Klinge Fig. 20 |
| 04-1022 | 1 Klinge Fig. 22 |
| 04-1023 | 2 Klängen Fig. 23 |
| 08-1660 | 1 Dose gelocht, für Klängen |
| 06-0210 | 4 CRILE Klemmen, gerade, 14 cm, 5 1/2" |
| 09-0116 | 1 anat. Pinzette, 13 cm, 5 1/8" |
| 09-0156 | 2 chir. Pinzetten, 13 cm, 5 1/8", 1x2 Zähne |
| 15-0204 | 1 Hohlsonde, 13 cm, 5 1/8" |
| 20-0211 | 2 Trachealhäkchen, stumpf, 17 cm, 6 3/4" |
| 87-0145 | 1 BOSE Trachealhäkchen, scharf, links, 16,5 cm, 6 1/2" |
| 87-0146 | 1 BOSE Trachealhäkchen, scharf, rechts, 16,5 cm, 6 1/2" |
| 87-0270 | 1 TROUSSEAU Trachealdilatator, 14 cm, 5 1/2" |
| 87-0452 | 1 LUER Trachealkanüle, Fig. 2, ø 6 mm, Neusilber |
| 87-0454 | 1 LUER Trachealkanüle, Fig. 4, ø 8 mm, Neusilber |
| 87-0650 | 1 Reinigungsbürste, 30,5 cm, 12" |

Tracheotomy set, complete, consisting of:

| | |
|---------|---|
| 57-1296 | 1 Rack |
| 57-1298 | 1 Rack |
| 07-0962 | 1 Metal case |
| 04-1055 | 1 Handle No. 4 |
| 04-1020 | 1 Blade fig. 20 |
| 04-1022 | 1 Blade fig. 22 |
| 04-1023 | 2 Blades fig. 23 |
| 08-1660 | 1 Perforated case, for blades |
| 06-0210 | 4 CRILE Artery forceps, straight, 14 cm, 5 1/2" |
| 09-0116 | 1 Dissecting forceps, 13 cm, 5 1/8" |
| 09-0156 | 2 Tissue forceps, 13 cm, 5 1/8", 1x2 teeth |
| 15-0204 | 1 Grooved director, 13 cm, 5 1/8" |
| 20-0211 | 2 Trachea retractors, blunt 17 cm, 6 3/4" |
| 87-0145 | 1 BOSE Trachea retractor, sharp, left, 16,5 cm, 6 1/2" |
| 87-0146 | 1 BOSE Trachea retractor, sharp, right, 16,5 cm, 6 1/2" |
| 87-0270 | 1 TROUSSEAU Trachea dilator, 14 cm, 5 1/2" |
| 87-0452 | 1 LUER Trachea tube, fig. 2, ø 6 mm, German silver |
| 87-0454 | 1 LUER Trachea tube, fig. 4, ø 8 mm, German silver |
| 87-0650 | 1 Cleaning brush, 30 cm, 12" |

Jeu d'instruments pour trachéotomie, complet, composé de:

| | |
|---------|--|
| 57-1296 | 1 Chevalet |
| 57-1298 | 1 Chevalet |
| 07-0962 | 1 Boîte métal |
| 04-1055 | 1 Manche de bistouri No. 4 |
| 04-1020 | 1 Lame fig. 20 |
| 04-1022 | 1 Lame fig. 22 |
| 04-1023 | 2 Lames fig. 23 |
| 08-1660 | 1 Boîte perforée, pour lames |
| 06-0210 | 4 Pincés hémostatiques CRILE, droites 14 cm, 5 1/2" |
| 09-0116 | 1 Pince à dissection, 13 cm, 5 1/8" |
| 09-0156 | 2 Pincés à griffes, 13 cm, 5 1/8", 1x2 dents |
| 15-0204 | 1 Sonde cannelée, 13 cm, 5 1/8" |
| 20-0211 | 2 écarteurs pour trachéotomie, moux, 17 cm, 6 3/4" |
| 87-0145 | 1 BOSE écarteur pour trachéotomie, pointu, à gauche, 16,5 cm, 6 1/2" |
| 87-0146 | 1 BOSE écarteur pour trachéotomie, pointu, à droite, 16,5 cm, 6 1/2" |
| 87-0270 | 1 TROUSSEAU dilataeur trachéal, 14 cm, 5 1/2" |
| 87-0452 | 1 LUER canule trachéale, fig. 2, ø 6 mm, argent blanc |
| 87-0454 | 1 LUER canule trachéale, fig. 4, ø 8 mm, argent blanc |
| 87-0650 | 1 Brosse à nettoyer, 30 cm, 12" |

Juego para traqueotomía, completo, compuesto de:

| | |
|---------|--|
| 57-1296 | 1 Depositivo |
| 57-1298 | 1 Depositivo |
| 07-0962 | 1 Caja de esterilización |
| 04-1055 | 1 Mango No. 4 |
| 04-1020 | 1 Hoja fig. 20 |
| 04-1022 | 1 Hoja fig. 22 |
| 04-1023 | 2 Hojas fig. 23 |
| 08-1660 | 1 Cajita perforada, para hojas |
| 06-0210 | 4 CRILE Pinzas hemostáticas, rectas, 14 cm, 5 1/2" |
| 09-0116 | 1 Pinza de disección, 13 cm, 5 1/8" |
| 09-0156 | 2 Pinzas quirúrgicas, con 1x2 dientes, 13 cm, 5 1/8" |
| 15-0204 | 1 Sonda acanalada, 13 cm, 5 1/8" |
| 20-0211 | 2 Separadores traqueales, romos, 17 cm, 6 3/4" |
| 87-0145 | 1 BOSE Separador traqueal, agudo, izquierdo, 16,5 cm, 6 1/2" |
| 87-0146 | 1 BOSE Separador traqueal, agudo, derecho, 16,5 cm, 6 1/2" |
| 87-0270 | 1 TROUSSEAU dilatador para la tráquea, 14 cm, 5 1/2" |
| 87-0452 | 1 LUER Cánula traqueal, fig. 2, ø 6 mm, de plata meneses |
| 87-0454 | 1 LUER Cánula traqueal, fig. 4, ø 8 mm, de plata meneses |
| 87-0650 | 1 Cepillo de limpieza, 30 cm, 12" |

Set per tracheotomia, completo, composto da:

| | |
|---------|---|
| 57-1296 | 1 Supporto |
| 57-1298 | 1 Supporto |
| 07-0962 | 1 Scatola in metallo |
| 04-1055 | 1 Manico per bisturi No. 4 |
| 04-1020 | 1 Lama fig. 20 |
| 04-1022 | 1 Lama fig. 22 |
| 04-1023 | 2 Lama fig. 23 |
| 08-1660 | 1 Scatoletta perforata, per lame |
| 06-0210 | 4 Pinze emostatiche CRILE, rette, 14 cm, 5 1/2" |
| 09-0116 | 1 Pinza per dissezione, 13 cm, 5 1/8" |
| 09-0156 | 2 Pinze per dissezione con denti 1x2, 13 cm, 5 1/8" |
| 15-0204 | 1 Sonda scanalata, 13 cm, 5 1/8" |
| 20-0211 | 2 Uncini tracheali, smussi, 17 cm, 6 3/4" |
| 87-0145 | 1 Uncino tracheale BOSE, acuto, sinistra, 16,5 cm, 6 1/2" |
| 87-0146 | 1 Uncino tracheale BOSE, acuto, destra, 16,5 cm, 6 1/2" |
| 87-0270 | 1 Dilatatore tracheale TROUSSEAU, 14 cm, 5 1/2" |
| 87-0452 | 1 Cannula tracheale LUER, fig. 2, ø 6 mm, argento bianco |
| 87-0454 | 1 Cannula tracheale LUER, fig. 4, ø 8 mm, argento bianco |
| 87-0650 | 1 Spazzolino per pulire, 30 cm, 12" |



LAWNTON

Medizintechnik



Sterilisation, Verschiedenes
Sterilization, Miscellaneous
Esterilización, Diversos artículos
Stérilisation, Divers articles
Sterilizzazione, Articoli vari



PREP LUBE ein flüssiges Konzentrat zur Pflege chirurgischer Instrumente
PREP LUBE a liquid concentrate for surgical instrument care
PREP LUBE un líquido concentrato para el cuidado del instrumental quirúrgico
PREP LUBE liquide concentré pour entretien des instruments
PREP LUBE liquido concentrato per la cura degli strumenti chirurgici

EIGENSCHAFTEN

- Keine ölhaltigen Ablagerungen
- Verlängert die Lebensdauer der Instrumente
- Angenehm im Geruch
- Verhindert Rostbildung
- Keine Bakterienbildung
- Konzentriert

BESCHREIBUNG

PREP LUBE ist ein Schmiermittel auf Emulsionsbasis, entwickelt speziell zur Schmierung und zum Oberflächenschutz von chirurgischen Instrumenten. Routinemäßige Behandlung der Instrumente mit PREP LUBE nach jedem Reinigungsvorgang verlängert deren Lebensdauer.

Es eignet sich ausgezeichnet zum Lösen von festgefressenen Schlüssen, da es durch seine kriechende Eigenschaft in engste Spalten vordringt.

Das gelieferte Konzentrat wird für den Gebrauch im Verhältnis 1:6 mit Wasser verdünnt. Die Instrumente werden in diese Verdünnung getaucht. Man läßt sie abtropfen ohne nachträgliches Abspülen oder Abwischen.

Die Verdünnung bleibt 2 Wochen lang gebrauchsfähig, verhindert jedes Bakterienwachstum und kann wiederholt verwendet werden. Ein zusätzliches Rostschutzmittel verhindert jede Rostbildung, wenn Instrumente mit PREP LUBE behandelt werden.

FEATURES

- No oily residue
- Extends Instrument Life
- Pleasantly Scented
- Anticorrosive
- Bacteriostatic
- Concentrated

DESCRIPTION

PREP LUBE is an emulsified lubrication oil, formulated specifically to lubricate and protect surgical instruments. Routine lubrication of instruments following each cleaning extends their effective life span.

Excellent for loosening „frozen“ box locks, PREP LUBE penetrates deeply into hinges, keeping all parts moving freely.

The concentrate is diluted one to six parts of water for actual use. Instruments are immersed in to the dilution, and then allowed to drain without rinsing or wiping.

The dilution remains stable for two weeks and, being effectively preserved to prevent bacterial growth, may be reused repeatedly. An added rust inhibition system prevents rust formation on instruments being soaked in the instrument bath.

CARACTERÍSTICAS

- Sin residuos oleosos
- Prolonga la vida útil del instrumento
- Con olor agradable
- Anticorrosivo
- Bacterioestático
- Concentrado

DESCRIPCIÓN

PREP LUBE es una emulsión oleosa lubricante especialmente creada para la lubricación de los instrumentos quirúrgicos y la protección de su superficie. El tratamiento periódico de los mismos con PREP LUBE después de cada limpieza prolonga su vida útil.

Es excelente para aflojar cerraduras atascadas, pues puede penetrar fácilmente en cavidades de difícil acceso.

El concentrado se ha de diluir en abundante agua en una proporción 1:6 para su uso. Los instrumentos se sumergen en la solución. Después se dejan escurrir sin enjuagarlos ni secarlos.

La solución permanece durante dos semanas apta para el uso, evita la formación de bacterias y puede ser usada repetidas veces. Un producto antioxidante adicional evita la oxidación en los productos tratados con PREP LUBE.

CARACTERISTIQUES

- Pas de dépôts huileux
- Augmente la durée de vie des instruments
- Odeur agréable
- Empêche l'oxydation
- Pas de formation de bactéries
- Concentré

DESCRIPTION

PREP LUBE est un lubrifiant à base d'émulsion, mis au point spécialement pour la lubrification et la protection des instruments chirurgicaux. Le traitement de routine des instruments avec PREP LUBE après chaque opération de nettoyage prolonge leur durée de vie.

Il convient parfaitement pour éliminer les corps incrustés; en effet, sa propriété rampante lui permet de pénétrer dans les fentes les plus étroites.

Pour l'utiliser, diluer le concentré livré avec de l'eau à raison de 1:6. Plonger les instruments dans cette solution. Les laisser s'égoutter sans rincer ou sécher au chiffon.

La solution reste utilisable pendant 2 semaines, elle empêche toute croissance bactérienne et peut être utilisée plusieurs fois. Un anti-oxydant supplémentaire empêche toute formation de rouille lorsque les instruments sont traités au PREP LUBE.

CARATTERISITCHE

- Senza residui oleosi
- Prolunga la vita degli strumenti
- Odore gradevole
- Anticorrosivo
- Batteriostatico
- Concentrato

DESCRIZIONE

PREP LUBE e' un' emulsione oleosa lubrificante creata per la lubrificazione e la protezione degli strumenti chirurgici. Una lubrificazione di routine degli strumenti dopo la pulizia prolunga la loro vita effettiva.

Eccellente per prevenire blocchi, PREP LUBE penetra profondamente nei cardini, mantenendo le parti libere di muoversi.

Il concentrato va diluito 1 a 6 parti di acqua per impiego normale. Gli strumenti vanno immersi e quindi lasciati ad asciugare senza risciacquare od asciugare.

La soluzione rimane stabile per due settimane, e poiche'evita la formazione di batteri, può essere impiegata ripetutamente. Un additivo antiossidante previene la formazione di ruggine sugli strumenti trattati con PREP LUBE.

PREP LUBE ein flüssiges Konzentrat zur Pflege chirurgischer Instrumente
 PREP LUBE a liquid concentrate for surgical instrument care
 PREP LUBE un líquido concentrato para el cuidado del instrumental quirúrgico
 PREP LUBE liquide concentré pour entretien des instruments
 PREP LUBE liquido concentrato per la cura degli strumenti chirurgici



1/3

04-0502
500 ml

Instrumenten-Pflegemittel in Kunststoffflasche
 Instrument care lubricant in plastic bottle
 Detergente para instrumentos en botella de plástico
 Détergent pour instruments en flacon plastique
 Detergente per strumenti in contenitore di plastica



1/3

► 04-0500 5 l
04-0504 4 x 5 l

Instrumenten-Pflegemittel in Kunststoffflasche
 Instrument care lubricant in plastic bottle
 Detergente para instrumentos en botella de plástico
 Détergent pour instruments en bidon plastique
 Detergente per strumenti in contenitore di plastica



1/2

04-0506

Instrumenten-Pflegemittel in Stift, nachfüllbar
 Instrument care lubricant in pen, refillable
 Detergente para instrumentos en pluma, rellenable
 Détergent pour instruments en stylo, rechargeable
 Detergente per strumenti su penna, ricaricabile



1/3

04-0508
250 ml

Instrumenten-Pflegemittel in Tropfflasche
 Instrument care lubricant in drop bottle
 Detergente para instrumentos en frasco cuentagotas
 Détergent pour instruments en flacon à compte gouttes
 Detergente per strumenti in contenitore con conta gocce



Sterilisierzangen
Sterilizing Forceps
Pinzas para esterilización
Pinces à stérilisation
Pinze per sterilizzazione



► 07-0265 20,5 cm, 8"
07-0270 29,0 cm, 11 $\frac{1}{2}$ "



07-0282
20 cm, 8"



ROGGE
07-0288
23,5 cm, 9 $\frac{1}{4}$ "



CHEATTLE
07-0260
27 cm, 10 $\frac{3}{4}$ "



CHEATTLE
07-0261
28 cm, 11"

Abfallzange
Pick-up Forceps
Pinza para desechos
Pince à déchets
Pinza raccogliatrice

Kappenzangen
Sterilizing Forceps
Combinación tapa/pinza
Combinaison couvercle/pince
Sterilizzatore per pinze



SAUERBRUCH
07-0300
55 cm, 22"

Abfallzange
Pick-up forceps
Pinza para desechos
Pince à déchets
Pinza raccogliatrice

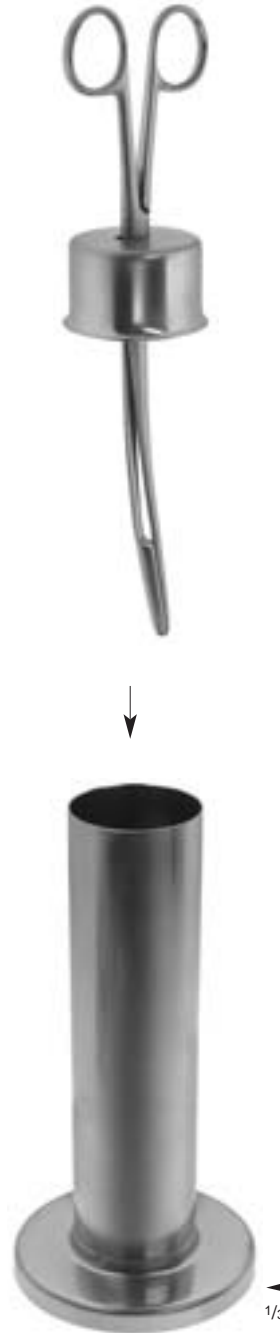

► **07-0302**

Kappenzange bestehend aus:
07-0303 1 Kornzange 25 cm, gebogen, mit Kappe (Deckel)
07-0304 1 Standgefäß mit großer Bodenplatte (standsicher)

Sterilizing forceps consisting of:
07-0303 1 Sterilizing forceps 25 cm, curved, with lid
07-0304 1 Jar with wide bottom plate (anti-tilt)

Combinación tapa/pinza compuesta de:
07-0303 1 Pinza para vendaje 25 cm, curva, con tapa
07-0304 1 Tarro con placa de pie grande (estable)

Combinaison couvercle/pince, composée de:
07-0303 1 Pince à tampons 25 cm, courbe, avec couvercle
07-0304 1 Eprouvette porte-pince avec large pied (stable)

Sterilizzatore per pinze composto di:
07-0303 1 Pinza per medicatura 25 cm, curva, con coperchio
07-0304 1 Contenitore con fondo largo (stabile)

07-0306

Kappenzange bestehend aus:
07-0307 1 Kornzange 32 cm, gebogen, mit Kappe (Deckel)
07-0308 1 Standgefäß mit großer Bodenplatte (standsicher)

Sterilizing forceps consisting of:
07-0307 1 Sterilizing forceps 32 cm, curved, with lid
07-0308 1 Jar with wide bottom plate (anti-tilt)

Combinación tapa/pinza compuesta de:
07-0307 1 Pinza para vendaje 32 cm, curva, con tapa
07-0308 1 Tarro con placa de pie grande (estable)

Combinaison couvercle/pince, composée de:
07-0307 1 Pince à tampons 32 cm, courbe, avec couvercle
07-0308 1 Eprouvette porte-pince avec large pied (stable)

Sterilizzatore per pinze composto di:
07-0307 1 Pinza per medicatura 32 cm, curva, con coperchio
07-0308 1 Contenitore con fondo largo (stabile)



Sterilisierklammern und -gestelle für Ringinstrumente
Safety Pins and Racks for holding Ring Handle Instruments
Imperdibles para esterilización, Porta-instrumentos
Epingle à instruments
Spilli di sicurezza e telai per trattenere gli strumenti

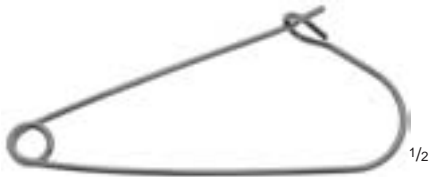

BLUNT
07-0295
10,5 cm, 4 1/8"

Sterilisierklammer
Safety pin
Imperdible para esterilización
Epingle à instruments
Spillo di sicurezza

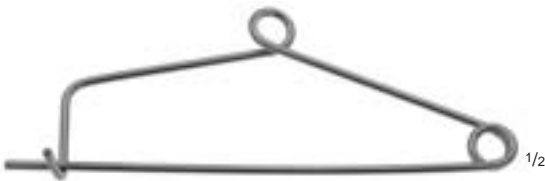

MAYO
07-0296
13,5 cm, 5 1/4"

Sterilisierklammer
Safety pin
Imperdible para esterilización
Epingle à instruments
Spillo di sicurezza



MAYO
07-0297
13,5 cm, 5 1/4"

Sterilisierklammer
Safety pin
Imperdible para esterilización
Epingle à instruments
Spillo di sicurezza

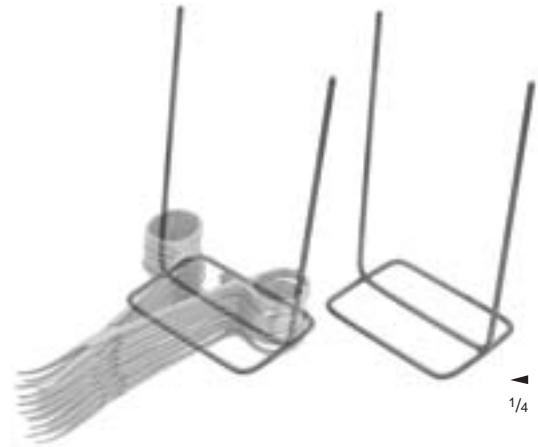

► 07-0350
15,5 cm, 6"

Sterilisiergestell für 36 Ringgriffinstrumente, 1 Paar
Safety rack for 36 ring handle instruments, 1 pair
Porta-instrumento para 36 instrumentos con mangos de anillo, 1 par
Porte instruments pour 36 instruments à anneaux, 1 paire
Telaio per 36 strumenti, 1 paio

07-0352
25,5 cm, 10"

Sterilisiergestell für 60 Ringgriffinstrumente, 1 Paar
Safety rack for 60 ring handle instruments, 1 pair
Porta-instrumento para 60 instrumentos con mangos de anillo, 1 par
Porte instruments pour 60 instruments à anneaux, 1 paire
Telaio per 60 strumenti, 1 paio



07-0400
13 cm, 5 1/8"

Nadel-Sterilisationsgestell
Suture needle sterilizing rack
Soporte para esterilizar las agujas de sutura
Support pour stériliser les aiguilles à suture
Telaio per sterilizzare aghi per sutura



07-0401
13 cm, 5 1/8"

Stab für 07-0400
Rod for 07-0400
Varilla para 07-0400
Tige pour 07-0400
Supporto per 07-0400

Sterisierrahmen
Sterilizing Racks
Porta-instrumentos
Cadres de stérilisation
Telaio per sterilizzazione

Bereitstellungsbecher
Storing Cup
Tarro
Goblet
Contenitori



57-1272
190 x 96 x 30 mm

Sterisierrahmen für 8 Mikro-Instrumente
Sterilizing rack for 8 micro instruments
Porta-instrumento para 8 micro instrumentos
Chevalet de stérilisation pour 8 instruments de la micro-chirurgie
Telaio per sterilizzazione per 8 micro-strumenti



57-1276
190 x 96 x 30 mm

Sterisierrahmen für 10 Mikro-Instrumente
Sterilizing rack for 10 micro instruments
Porta-instrumento para 10 micro instrumentos
Chevalet de stérilisation pour 10 instruments de la micro-chirurgie
Telaio per sterilizzazione per 10 micro-strumenti



07-1066

Bereitstellungs-Becher mit Silikon-Bodenplatte
(07-1067) für Mikro-Instrumente

Storing cup with silicon bottom plate (07-1067)
for micro instruments

Tarro con silicóna al fondo (07-1067)
para instrumental micro

Boîte ronde pour instruments de micro-chirurgie
avec plaque de fond en silicone (07-1067)

Contenitore per micro-strumenti con
fondo piatto in silicone (07-1067)



Sterilisier- und Bereitschaftsbehälter
Sterilizing and Storing Cases
Cajas para esterilización y conservación
Boîtes pour stérilisation et conservation
Cestelli per sterilizzazione e conservazione



1/4

Sterilisier- und Bereitschaftsbehälter,
 Deckel gelocht/Boden gelocht

Sterilizing and storing cases,
 lid perforated/bottom perforated

Cajas para esterilización y conservación,
 tapa perforada/fondo perforado

Boîtes pour stérilisation et conservation,
 couvercle perforé/fond perforé

Cestelli per sterilizzazione e conservazione,
 coperchio perforato/fondo perforato

Abmessungen (L x B x H)
 Sizes (l x w x h)
 Tamaños (l x f x a)
 Dimensions (lo. x hau. x la.)
 Dimensioni (L. x l. x h)

230 x 130 x 50 mm
 260 x 150 x 50 mm
 275 x 235 x 50 mm
 300 x 200 x 50 mm
 325 x 275 x 50 mm
 420 x 175 x 50 mm
 230 x 130 x 75 mm
 260 x 150 x 75 mm
 300 x 200 x 75 mm
 325 x 275 x 75 mm
 420 x 175 x 75 mm

Behälter
 Cases
 Cajas
 Boîtes
 Recipienti

07-0710
 ▶ 07-0711
 07-0728
 07-0712
 07-0715
 07-0716
 07-0700
 07-0701
 07-0702
 07-0705
 07-0706

Satz Spezialfilter, 5 Paar
 Set of special filters, 5 pairs
 Juego de filtros especiales, 5 pares
 Jeu de 5 paires de filtres spéciaux
 Set di 5 paia di filtri speciali

07-1710
 07-1711
 07-1728
 07-1712
 07-1715
 07-1716
 07-1700
 07-1701
 07-1702
 07-1705
 07-1706



1/4

Deponette,
 Deckel ungelocht/Boden gelocht

Deponette,
 lid non-perforated/bottom perforated

Deponette,
 tapa sin perforación/fondo perforado

Deponette,
 couvercle non perforé, fond perforé

Deponette,
 coperchio non perforato/fondo perforato

Abmessungen (L x B x H)
 Sizes (l x w x h)
 Tamaños (l x f x a)
 Dimensions (lo. x hau. x la.)
 Dimensioni (L. x l. x h)

245 x 135 x 35 mm
 245 x 135 x 50 mm
 245 x 135 x 60 mm

Behälter
 Cases
 Cajas
 Boîtes
 Recipienti

07-0871
 ▶ 07-0872
 07-0873

Satz Spezialfilter, 5 Paar
 Set of special filters, 5 pairs
 Juego de filtros especiales, 5 pares
 Jeu de 5 paires de filtres spéciaux
 Set di 5 paia di filtri speciali

07-1871
 07-1872
 07-1873



1/5

07-0607

295 x 215 x 67 mm (außen, outside, exterior, extérieur, esterne)
280 x 195 x 55 mm (innen, inside, interior, intérieur, interne)

07-0613

280 x 275 x 67 mm (außen, outside, exterior, extérieur, esterne)
265 x 255 x 55 mm (innen, inside, interior, intérieur, interne)

07-0618

400 x 280 x 67 mm (außen, outside, exterior, extérieur, esterne)
380 x 260 x 55 mm (innen, inside, interior, intérieur, interne)

07-0626

490 x 270 x 67 mm (außen, outside, exterior, extérieur, esterne)
470 x 250 x 55 mm (innen, inside, interior, intérieur, interne)

Sterilisierbehälter mit Bodenlochung (Deckel ungelocht) und Metall-Dauerfilter für Heißluft- und Dampfsterilisation. Herausnehmbare Siebplatte mit Silikonbank dient zur schonenden Lagerung von Instrumenten.

Sterilizing boxes, bottom perforated (lid non-perforated), with long-term metal filter for hot air and steam sterilization. Removable perforated tray with silicone cushions used to store instruments carefully.

Cajas de esterilización con fondo perforado (tapa sin perforación) y filtro de metal de larga duración para la esterilización con aire caliente o al vapor. Bandeja retirable con soportes de silicona, que sirven para el almacenaje cuidadoso.

Boîtes pour stérilisation avec fond perforé (couvercle sans perforation) et filtre permanent en métal pour stérilisation à air chaud et à vapeur. Plateau perforé amovible avec tapis en silicone permettant de ranger soigneusement les instruments.

Cestelli per sterilizzazione con fondo perforato (coperchio non-perforato) e filtro metallico a lunga durata per sterilizzazione ad aria calda e vapore. Inserti estraibili con supporto in silicone permettono una custodia adeguata.

▶ **07-0609**

295 x 215 x 67 mm (außen, outside, exterior, extérieur, esterne)
280 x 195 x 55 mm (innen, inside, interior, intérieur, interne)

07-0614

280 x 275 x 67 mm (außen, outside, exterior, extérieur, esterne)
265 x 255 x 55 mm (innen, inside, interior, intérieur, interne)

07-0619

400 x 280 x 67 mm (außen, outside, exterior, extérieur, esterne)
380 x 260 x 55 mm (innen, inside, interior, intérieur, interne)

07-0627

490 x 270 x 67 mm (außen, outside, exterior, extérieur, esterne)
470 x 250 x 55 mm (innen, inside, interior, intérieur, interne)

Sterilisierbehälter mit Deckel- und Bodenlochung und Textil-Langzeitfilter für Dampfsterilisation. Herausnehmbare Siebplatte mit Silikonbank dient zur schonenden Lagerung von Instrumenten.

Sterilizing boxes, lid and bottom perforation, with long-term textile filter for steam sterilization. Removable perforated tray with silicone cushions used to store instruments carefully.

Cajas de esterilización con tapa y fondo perforado y filtro de tejido de larga duración para la esterilización al vapor. Bandeja retirable con soportes de silicona, que sirven para el almacenaje cuidadoso.

Boîtes pour stérilisation avec fond et couvercle perforés et filtre tissu longue durée pour stérilisation à vapeur. Plateau perforé amovible avec tapis en silicone permettant de ranger soigneusement les instruments.

Cestelli per sterilizzazione con coperchio e fondo perforati e filtro tessile a lunga durata per sterilizzazione a vapore. Inserti estraibili con supporto in silicone permettono una custodia adeguata.



Sterilisierbehälter
Sterilizing Boxes
Cajas de esterilización
Boîtes pour stérilisation
Cestelli per sterilizzazione



1/5

07-0707

295 x 215 x 50 mm (außen, outside, exterior, extérieur, esterne)
280 x 195 x 42 mm (innen, inside, interior, intérieur, interne)

07-0713

280 x 275 x 50 mm (außen, outside, exterior, extérieur, esterne)
265 x 255 x 42 mm (innen, inside, interior, intérieur, interne)

07-0718

400 x 280 x 50 mm (außen, outside, exterior, extérieur, esterne)
380 x 260 x 42 mm (innen, inside, interior, intérieur, interne)

07-0726

490 x 270 x 50 mm (außen, outside, exterior, extérieur, esterne)
470 x 250 x 42 mm (innen, inside, interior, intérieur, interne)

Sterilisierbehälter mit Bodenlochung (Deckel ungelocht) und Metall-Dauerfilter für Heißluft- und Dampfsterilisation. Herausnehmbare Siebplatte mit Silikonstreifen dient zur schonenden Lagerung von Instrumenten.

Sterilizing boxes, bottom perforated (lid non-perforated), with long-term metal filter for hot air and steam sterilization. Removable perforated tray with silicone cushions used to store instruments carefully.

Cajas de esterilización con fondo perforado (tapa sin perforación) y filtro de metal de larga duración para la esterilización con aire caliente o al vapor. Bandeja retirable con soportes de silicona, que sirven para el almacenaje cuidadoso.

Boîtes pour stérilisation avec fond perforé (couvercle sans perforation) et filtre permanent en métal pour stérilisation à air chaud et à vapeur. Plateau perforé amovible avec tapis en silicone permettant de ranger soigneusement les instruments.

Cestelli per sterilizzazione con fondo perforato (coperchio non-perforato) e filtro metallico a lunga durata per sterilizzazione ad aria calda e vapore. Inserti estraibili con supporto in silicone permettono una custodia adeguata.

► **07-0709**

295 x 215 x 50 mm (außen, outside, exterior, extérieur, esterne)
280 x 195 x 42 mm (innen, inside, interior, intérieur, interne)

07-0714

280 x 275 x 50 mm (außen, outside, exterior, extérieur, esterne)
265 x 255 x 42 mm (innen, inside, interior, intérieur, interne)

07-0719

400 x 280 x 50 mm (außen, outside, exterior, extérieur, esterne)
380 x 260 x 42 mm (innen, inside, interior, intérieur, interne)

07-0727

490 x 270 x 50 mm (außen, outside, exterior, extérieur, esterne)
470 x 250 x 42 mm (innen, inside, interior, intérieur, interne)

Sterilisierbehälter mit Deckel- und Bodenlochung und Textil-Langzeitfilter für Dampfsterilisation. Herausnehmbare Siebplatte mit Silikonstreifen dient zur schonenden Lagerung von Instrumenten.

Sterilizing boxes, lid and bottom perforation, with long-term textile filter for steam sterilization. Removable perforated tray with silicone cushions used to store instruments carefully.

Cajas de esterilización con tapa y fondo perforado y filtro de tejido de larga duración para la esterilización al vapor. Bandeja retirable con soportes de silicona, que sirven para el almacenaje cuidadoso.

Boîtes pour stérilisation avec fond et couvercle perforés et filtre tissu longue durée pour stérilisation à vapeur. Plateau perforé amovible avec tapis en silicone permettant de ranger soigneusement les instruments.

Cestelli per sterilizzazione con coperchio e fondo perforati e filtro tessile a lunga durata per sterilizzazione a vapore. Inserti estraibili con supporto in silicone permettono una custodia adeguata.

Sterilisierbehälter
Sterilizing Boxes
Cajas de esterilización
Boîtes pour stérilisation
Cestelli per sterilizzazione



07-2707

295 x 215 x 70 mm (außen, outside, exterior, extérieur, esterne)
280 x 195 x 55 mm (innen, inside, interior, intérieur, interne)

07-2713

280 x 275 x 70 mm (außen, outside, exterior, extérieur, esterne)
265 x 255 x 55 mm (innen, inside, interior, intérieur, interne)

07-2718

400 x 280 x 70 mm (außen, outside, exterior, extérieur, esterne)
380 x 260 x 55 mm (innen, inside, interior, intérieur, interne)

07-2726

490 x 270 x 70 mm (außen, outside, exterior, extérieur, esterne)
470 x 250 x 55 mm (innen, inside, interior, intérieur, interne)

Sterilisierbehälter mit Bodenlochung (Deckel ungelocht) und Metall-Dauerfilter für Heißluft- und Dampfsterilisation. 2 herausnehmbare Siebplatten mit Silikonstreifen dient zur schonenden Lagerung von Instrumenten.

Sterilizing boxes, bottom perforated (lid non-perforated), with long-term metal filter for hot air and steam sterilization. 2 removable perforated trays with silicone cushions used to store instruments carefully.

Cajas de esterilización con fondo perforado (tapa sin perforación) y filtro de metal de larga duración para la esterilización con aire caliente o al vapor. 2 bandejas retirable con soportes de silicona, que sirven para el almacenaje cuidadoso.

Boîtes pour stérilisation avec fond perforé (couvercle sans perforation) et filtre permanent en métal pour stérilisation à air chaud et à vapeur. 2 Plateaux perforés amovibles avec tapis en silicone permettant de ranger soigneusement les instruments.

Cestelli per sterilizzazione con fondo perforato (coperchio non-perforato) e filtro metallico a lunga durata per sterilizzazione ad aria calda e vapore. 2 Inserti estraibili con supporto in silicone permettono una custodia adeguata.

► 07-2709

295 x 215 x 70 mm (außen, outside, exterior, extérieur, esterne)
280 x 195 x 55 mm (innen, inside, interior, intérieur, interne)

07-2714

280 x 275 x 70 mm (außen, outside, exterior, extérieur, esterne)
265 x 255 x 55 mm (innen, inside, interior, intérieur, interne)

07-2719

400 x 280 x 70 mm (außen, outside, exterior, extérieur, esterne)
380 x 260 x 55 mm (innen, inside, interior, intérieur, interne)

07-2727

490 x 270 x 70 mm (außen, outside, exterior, extérieur, esterne)
470 x 250 x 55 mm (innen, inside, interior, intérieur, interne)

Sterilisierbehälter mit Deckel- und Bodenlochung und Textil-Langzeitfilter für Dampfsterilisation. 2 herausnehmbare Siebplatten mit Silikonstreifen dient zur schonenden Lagerung von Instrumenten.

Sterilizing boxes, lid and bottom perforation, with long-term textile filter for steam sterilization. 2 removable perforated trays with silicone cushions used to store instruments carefully.

Cajas de esterilización con tapa y fondo perforado y filtro de tejido de larga duración para la esterilización al vapor. 2 bandejas retirables con soportes de silicona, que sirven para el almacenaje cuidadoso.

Boîtes pour stérilisation avec fond et couvercle perforés et filtre tissu longue durée pour stérilisation à vapeur. 2 Plateaux perforés amovibles avec tapis en silicone permettant de ranger soigneusement les instruments.

Cestelli per sterilizzazione con coperchio e fondo perforati e filtro tessile a lunga durata per sterilizzazione a vapore. 2 Inserti estraibili con supporto in silicone permettono una custodia adeguata.



Steriliserbehälter aus Kunststoff
Sterilizing Boxes of Plastic
Cajas de esterilización de plástico
Boîtes pour stérilisation en plastique
Cestelli in plastica per sterilizzazione



07-0900

162 x 68 x 24 mm (außen, outside, exterior, extérieur, esterne)

152 x 63 x 19 mm (innen, inside, interior, intérieur, interne)

07-0902

175 x 107 x 24 mm (außen, outside, exterior, extérieur, esterne)

165 x 102 x 19 mm (innen, inside, interior, intérieur, interne)

07-0904

200 x 107 x 24 mm (außen, outside, exterior, extérieur, esterne)

190 x 102 x 19 mm (innen, inside, interior, intérieur, interne)

► 07-0906

264 x 157 x 24 mm (außen, outside, exterior, extérieur, esterne)

254 x 152 x 19 mm (innen, inside, interior, intérieur, interne)

Steriliserbehälter mit durchsichtigem Deckel und Silikonmatte dient zur Lagerung von Mikro-Instrumenten. Deckel- und Bodenlochung. Vor der Sterilisation in einen im Fachhandel erhältlichen Folienschlauch eingeschweißt, bleiben Behälter und Instrumente steril und einsatzbereit.

Sterilizing boxes with transparent cover and silicone cushion to store micro instruments. Lid and bottom perforation. The instruments and sterilizing box remain sterile and ready for operation when welded before sterilizing into a foil strip which can be obtained at the specialized dealer.

Caja de esterilización con tapa transparente y soporte de silicona, que sirven para el almacenaje de instrumental micro. Tapa y fondo perforado. Los instrumentos y la caja de esterilización permanecen estéril y preparados para operar si se envasa antes de la esterilización en una funda que se puede conseguir por un distribuidor especial.

Boîte pour stérilisation avec couvercle transparent et tapis en silicone utilisé pour ranger les instruments micro. Couvercle et fond perforés. Les instruments et la boîte restent stériles et prêts pour l'opération s'ils sont emballés sous sachets plastiques avant d'être stérilisés. Ces sachets peuvent être obtenus chez un distributeur spécialisé.

Cestelli per sterilizzazione con coperchio trasparente e supporto in silicone. Servono per la custodia degli strumenti micro. Coperchio e fondo perforati. Cestelli e strumenti restano sterili e pronti per l'impiego se, prima della sterilizzazione, vengono fissati in un tubo flessibile laminato, in vendita presso il commercio specializzato.



07-0916

264 x 157 x 43 mm (außen, outside, exterior, extérieur, esterne)

254 x 152 x 38 mm (innen, inside, interior, intérieur, interne)

Steriliserbehälter mit durchsichtigem Deckel, herausnehmbarem Siebplatte und 2 Silikonmatten dient zur Lagerung von Mikro-Instrumenten. Deckel- und Bodenlochung. Vor der Sterilisation in einen im Fachhandel erhältlichen Folienschlauch eingeschweißt, bleiben Behälter und Instrumente steril und einsatzbereit.

Sterilizing box with transparent cover, removable perforated tray and 2 silicone cushions to store micro instruments. Lid and bottom perforation. The instruments and sterilizing box remain sterile and ready for operation when welded before sterilizing into a foil strip which can be obtained at the specialized dealer.

Caja de esterilización con tapa transparente, 1 bandeja retirable y 2 soportes de silicona, que sirven para el almacenaje de instrumental micro. Coperchio e fondo perforado. Los instrumentos y la caja de esterilización permanecen estéril y preparados para operar si se envasa antes de la esterilización en una funda que se puede conseguir por un distribuidor especial.

Boîte pour stérilisation avec couvercle transparent, plateau perforé amovible et 2 tapis en silicone utilisés pour ranger les instruments micro. Couvercle et fond perforés. Les instruments et la boîte restent stériles et prêts pour l'opération s'ils sont emballés sous sachets plastiques avant d'être stérilisés. Ces sachets peuvent être obtenus chez un distributeur spécialisé.

Cestelli per sterilizzazione con coperchio trasparente, inserto estraibile e 2 supporti in silicone. Servono per la custodia degli strumenti micro. Coperchio e fondo perforati. Cestelli e strumenti restano sterili e pronti per l'impiego se, prima della sterilizzazione, vengono fissati in un tubo flessibile laminato, in vendita presso il commercio specializzato.

Sterilisiertrommeln
Sterilizing Drums
Cajas (tambores) de esterilización
Boîtes rondes pour stérilisation
Cestelli rotondi per sterilizzazione

Farbige Kennzeichnungsschilder
Coloured Identification Labels
Placas de identificación de color
Etiquettes d'identification, en couleur
Targhette di identificazione colorate



KONRICH
07-0846
- 07-0861

Sterilisiertrommeln
Sterilizing drums
Cajas (tambores) para esterilización
Boîtes rondes pour stérilisation
Cestelli rotondi per sterilizzazione

Abmessungen (ø)
Sizes (ø)
Tamaños (ø)
Dimensions (ø)
Dimensioni (ø)

100 x 100 mm
150 x 150 mm
200 x 150 mm
200 x 190 mm
240 x 160 mm
240 x 230 mm
290 x 160 mm
290 x 240 mm
340 x 160 mm
340 x 240 mm
390 x 145 mm
390 x 240 mm
390 x 290 mm

Behälter
Cases
Cajas
Boîtes
Recipienti

07-0846
07-0847
07-0850
07-0851
07-0852
07-0853
07-0855
07-0856
▶ 07-0854
07-0857
07-0858
07-0860
07-0861

Satz Spezialfilter, 5 Paar
Set of special filters, 5 pairs
Juego de filtros especiales, 5 pares
Jeu de 5 paires de filtres spéciaux
Set di 5 paia di filtri speciali

07-1846
07-1847
07-1850
07-1851
07-1852
07-1853
07-1855
07-1856
07-1854
07-1857
07-1858
07-1860
07-1861

07-0897

Kennzeichnungsschild für Sterilisier- und Bereitschaftsbehälter und Deponette. Text (bis 12 Buchstaben) und Farbe (rot, blau, grün, gelb, schwarz, silber) nach Wahl.

Identification label for sterilizing and storing cases and deponette. Inscription (up to 12 letters) and colour (red, blue, green, yellow, black, silver) upon choice.

Placas de identificación para cajas de esterilización y conservación y para deponette. Texto (hasta 12 letras) y color (rojo, azul, verde, amarillo, negro, plateado) a elección.

Etiquettes d'identification pour boîtes à stériliser. Texte (maximum 12 lettres) en couleur (rouges, bleues, vertes, jaunes, noires, argent).

Targhette di identificazione per la sterilizzazione, conservazione e deponette. Iscrizioni (sopra 12 lettere) e colori (rosso, blu, verde, giallo, nero, argento) a scelta.



1/2

07-0899

Kennzeichnungsschild für Sterilisiertrommeln, Sterilisier-Siebschalen und -körbe. Text (bis 12 Buchstaben) und Farbe (rot, blau, grün, gelb, schwarz, silber) nach Wahl.

Identification label for sterilizing drums, sterilizing trays and baskets. Inscription (up to 12 letters) and colour (red, blue, green, yellow, black, silver) upon choice.

Placas de identificación para cajas (tambores) de esterilización y bandejas/cestas de esterilización. Texto (hasta 12 letras) y color (rojo, azul, verde, amarillo, negro, plateado) a elección.

Etiquettes d'identification pour boîtes rondes et plateaux à stériliser. Texte (maximum 12 lettres) en couleur (rouges, bleues, vertes, jaunes, noires, argent).

Targhette di identificazione per la sterilizzazione di cestelli rotondi, vassoi e cestelli. Iscrizioni (sopra 12 lettere) e colori (rosso, blu, verde, giallo, nero, argento) a scelta.



1/2

07-0895

Schilderleiste
Label rack
Porta-placas
Porte-plaques
Porta targhette



1/5



Sterilisier-Siebschalen
Sterilizing Trays
Bandejas y cestas de esterilización
Plateaux de stérilisation
Cestelli per sterilizzazione



- ▶ 07-0766 260 x 260 x 50 mm
- 07-0767 260 x 260 x 80 mm
- 07-0768 260 x 260 x 100 mm

Sterilisier-Siebschalen aus perforiertem Blech, für Container 300 mm lang

Sterilizing trays of perforated steel sheet, for container 300 mm long

Bandejas de esterilización perforadas de chapa de acero para contenedores de 300 mm de largo

Plateaux en inox perforé pour stérilisation, pour container de 300 mm de longueur

Castelli in acciaio perforato per la sterilizzazione di contenitori lunghi 300 mm



- ▶ 07-0740 480 x 260 x 50 mm
- 07-0786 520 x 260 x 50 mm
- 07-0787 520 x 260 x 80 mm
- 07-0788 520 x 260 x 100 mm

Sterilisier-Siebschalen aus perforiertem Blech, für Container 600 mm lang

Sterilizing trays of perforated steel sheet, for container 600 mm long

Bandejas de esterilización perforadas de chapa de acero para contenedores de 600 mm de largo

Plateaux en inox perforé pour stérilisation, pour container de 600 mm de longueur

Castelli in acciaio perforato per la sterilizzazione di contenitori lunghi 600 mm



- 07-0730
- 240 x 240 x 60 mm

Sterilisier-Siebschale aus Drahtgeflecht, für Container 300 mm lang

Sterilizing tray of wire mesh, for container 300 mm long

Cesta de esterilización de alambre para contenedores de 300 mm de largo

Plateau en fil inox pour stérilisation, pour container de 300 mm de longueur

Castello in rete metallica per la sterilizzazione di contenitori lunghi 300 mm



- ▶ 07-0732 480 x 240 x 60 mm
- 07-0747 520 x 240 x 75 mm
- 07-0748 520 x 240 x 100 mm

Sterilisier-Siebschale aus Drahtgeflecht, für Container 600 mm lang

Sterilizing trays of wire mesh, for container 600 mm long

Cesta de esterilización de alambre para contenedores de 600 mm de largo

Plateau en fil inox pour stérilisation, pour container de 600 mm de longueur

Castello in rete metallica per la sterilizzazione di contenitori lunghi 600 mm

Sterilisier-Körbe
Sterilizing Baskets
Cestas de esterilización
Paniers de stérilisation
Castelli per sterilizzazione

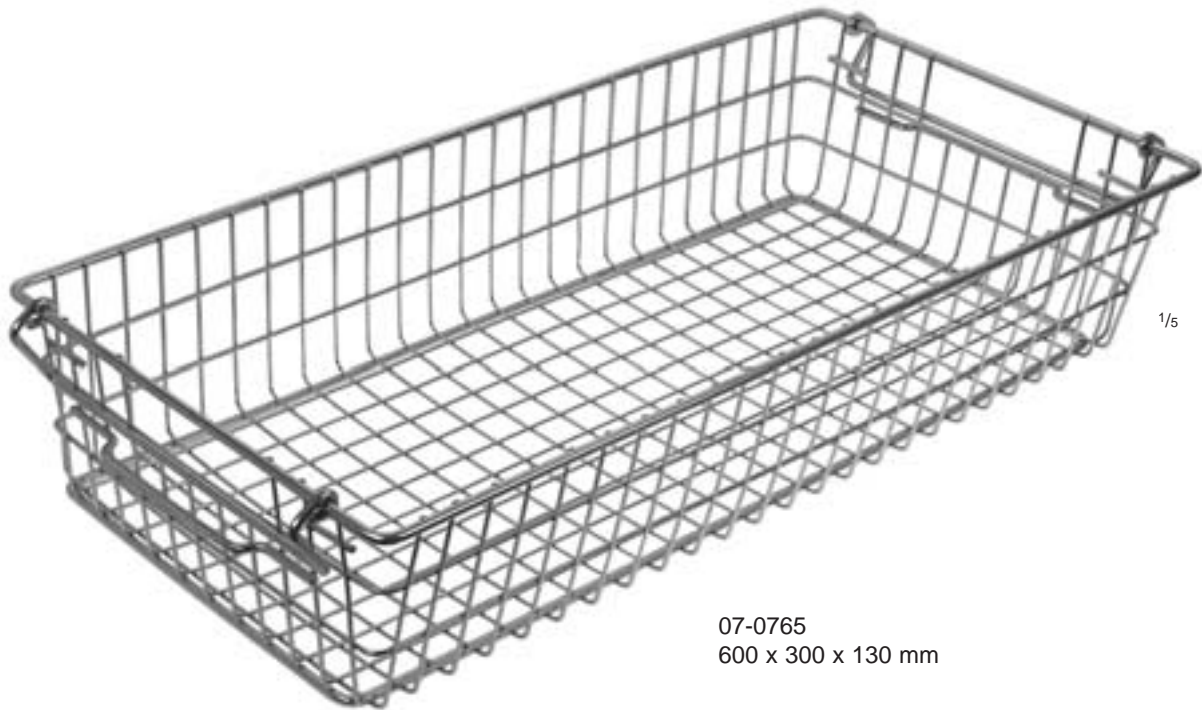

1/5

07-0765
600 x 300 x 130 mm

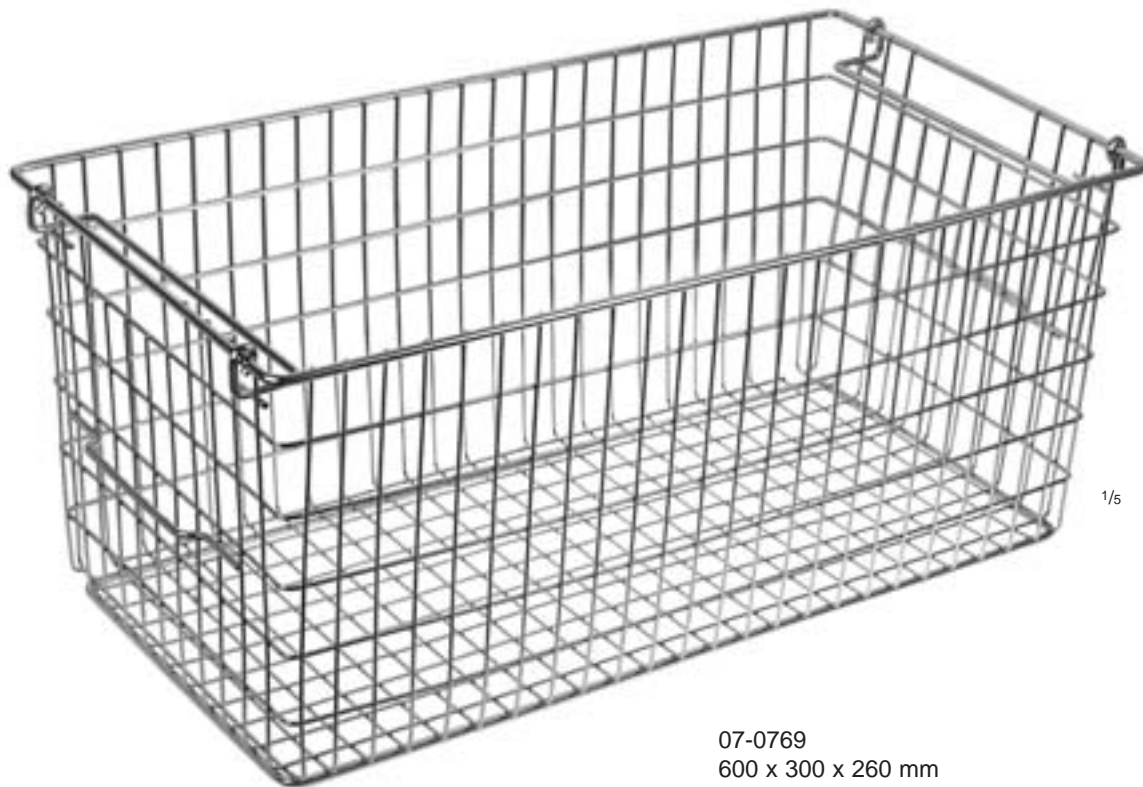

1/5

07-0769
600 x 300 x 260 mm



Instrumentenkästen
Instrument Boxes
Cajas para instrumentos
Boîtes pour instruments
Cassette per strumenti



1/4

Abmessungen (L x B x H)
Sizes (l x w x h)
Tamaños (l x f x a)
Dimensions (lo. x hau. x la.)
Dimensioni (L x l x h)

| | |
|-----------|-------------------|
| 07-1260 | 165 x 85 x 35 mm |
| 07-1261 | 200 x 100 x 35 mm |
| 07-1262 | 200 x 100 x 50 mm |
| 07-1263 | 230 x 130 x 50 mm |
| ▶ 07-1264 | 260 x 150 x 50 mm |
| 07-1265 | 270 x 235 x 50 mm |
| 07-1266 | 300 x 200 x 50 mm |
| 07-1267 | 325 x 275 x 50 mm |

mit Knopfdeckel
lid with knob
tapa con botón
avec couvercle à bouton
con coperchio a bottone



1/4

Abmessungen (L x B x H)
Sizes (l x w x h)
Tamaños (l x f x a)
Dimensions (lo. x hau. x la.)
Dimensioni (L x l x h)

| | |
|-----------|-------------------|
| 07-1270 | 165 x 85 x 35 mm |
| 07-1271 | 200 x 100 x 35 mm |
| 07-1272 | 200 x 100 x 50 mm |
| 07-1273 | 230 x 130 x 50 mm |
| ▶ 07-1274 | 260 x 150 x 50 mm |
| 07-1275 | 270 x 235 x 50 mm |
| 07-1276 | 300 x 200 x 50 mm |
| 07-1277 | 325 x 275 x 50 mm |

Deckel ohne Knopf
lid without knob
tapa sin botón
avec couvercle sans bouton
con coperchio senza bottone



1/4

07-1280
205 x 105 x 35 mm

Deckel ohne Knopf
lid without knob
tapa sin botón
avec couvercle sans bouton
con coperchio senza bottone

Standgefäße
Jars
Tarrós
Récipients cylindriques
Recipienti cilindrici

Dosen
Containers
Recipientes
Récipients
Recipienti



1/2



1/2



1/2

Abmessungen (ø x H)
Sizes (lø x h)
Tamaños (ø x a)
Dimensions (ø x la.)
Dimensioni (ø x h)

30 x 90 mm
50 x 100 mm
50 x 125 mm
50 x 175 mm
75 x 100 mm
75 x 130 mm
75 x 175 mm
100 x 175 mm
100 x 200 mm

Standgefäß ohne Deckel
Jar without lid
Tarro sin tapa
Récipient sans couvercle
Recipiente senza coperchio

07-1050
07-1056
▶ 07-1051
07-1057
07-1058
07-1059
07-1054
07-1061
07-1055

Deckel allein
Lid only
Tapa suelta
Couvercle seul
Coperchio solo

—
07-1071
▶ 07-1072
07-1073
07-1074
07-1075
07-1076
07-1077
07-1078

Deckel allein mit Dreieck-Aussparung
Lid only with triangle hole
Tapa sola con abertura en triángulo
Couvercle seul avec ouverture triangulaire
Coperchio solo con apertura triangolare

—
07-1081
▶ 07-1082
07-1083
07-1084
07-1085
07-1086
07-1087
07-1088



1/2

Abmessungen (ø x H)
Sizes (lø x h)
Tamaños (ø x a)
Dimensions (ø x la.)
Dimensioni (ø x h)

07-1041 75 x 60 mm
07-1042 75 x 75 mm
07-1043 100 x 60 mm
07-1044 100 x 100 mm
▶ 07-1045 125 x 80 mm
07-1046 125 x 125 mm
07-1047 150 x 150 mm

Dosen, mit Knopfdeckel
Containers, lid with knob
Recipientes, tapa con botón
Récipients avec couvercle à bouton
Recipienti con coperchio a bottone



Instrumentenablegeplatten
Instrument Storing Trays
Bandejas para instrumentos
Plateaux pour instruments
Vassoi porta strumenti

Schalen
Trays
Bandejas
Bassins
Bacinelle



Abmessungen (L x B x H)
Sizes (l x w x h)
Tamaños (l x f x a)
Dimensions (lo. x hau. x la.)
Dimensioni (L x l x h)

| | |
|-----------|-------------------|
| 07-1100 | 210 x 160 x 10 mm |
| 07-1101 | 240 x 180 x 10 mm |
| ▶ 07-1102 | 310 x 150 x 10 mm |
| 07-1103 | 310 x 210 x 10 mm |
| 07-1104 | 350 x 240 x 10 mm |
| 07-1105 | 400 x 270 x 10 mm |
| 07-1106 | 420 x 280 x 10 mm |

Instrumentenablegeplatten
Instrument storing trays
Bandejas para instrumentos
Plateaux pour instruments
Vassoi porta strumenti



Abmessungen (L x B x H)
Sizes (l x w x h)
Tamaños (l x f x a)
Dimensions (lo. x hau. x la.)
Dimensioni (L x l x h)

| | |
|-----------|-------------------|
| 07-1110 | 230 x 155 x 30 mm |
| 07-1111 | 300 x 175 x 30 mm |
| ▶ 07-1112 | 300 x 175 x 40 mm |
| 07-1113 | 350 x 240 x 36 mm |
| 07-1114 | 400 x 300 x 50 mm |

Mehrzweckschalen
Universal trays
Bandejas universales
Bassins universal
Bacinelle universali



07-1120
235 x 190 x 40 mm

Schwenkschale
Tray
Bandeja rectangulares
Bassin et cuvette pour guéridons
Bacinelle rettangolari

Spülschalen
Solution Bowls
Cubetas para soluciones
Cupules
Scodelle per soluzioni

Waschschüsseln
Wash Bowls
Palanganas
Cuvettes
Scodelle per liquidi



| | Abmessungen (ø x H) Sizes (lø x h) Tamaños (ø x a) Dimensions (ø x la.) Dimensioni (ø x h) | Inhalt Capacity Cabida Capacité Capacità |
|-----------|--|--|
| 07-1000 | 70 x 35 mm | 0,1 l |
| 07-1001 | 90 x 50 mm | 0,2 l |
| 07-1002 | 100 x 65 mm | 0,3 l |
| 07-1003 | 115 x 65 mm | 0,4 l |
| 07-1004 | 120 x 70 mm | 0,5 l |
| 07-1010 | 150 x 75 mm | 0,7 l |
| 07-1011 | 155 x 85 mm | 1,0 l |
| 07-1012 | 195 x 120 mm | 2,0 l |
| 07-1013 | 220 x 120 mm | 2,7 l |
| 07-1015 | 245 x 130 mm | 4,0 l |
| 07-1018 | 290 x 150 mm | 5,5 l |
| 07-1019 | 305 x 175 mm | 8,0 l |
| 07-1020 | 360 x 185 mm | 12,0 l |
| ▶ 07-1021 | 370 x 200 mm | 14,0 l |

Spülschalen
Solution bowls
Cubetas para soluciones
Cuvettes
Scodelle per soluzioni



| | Abmessungen (ø x H) Sizes (lø x h) Tamaños (ø x a) Dimensions (ø x la.) Dimensioni (ø x h) | Inhalt Capacity Cabida Capacité Capacità |
|-----------|--|--|
| ▶ 07-1022 | 330 x 90 mm | 6,0 l |
| 07-1023 | 330 x 115 mm | 8,0 l |

Waschschüsseln
Wash bowls
Palanganas
Cuvettes
Scodella per liquidi



| | Abmessungen (ø x H) Sizes (lø x h) Tamaños (ø x a) Dimensions (ø x la.) Dimensioni (ø x h) | Inhalt Capacity Cabida Capacité Capacità |
|-----------|--|--|
| 07-1130 | 40 x 19 mm | 0,05 l |
| 07-1131 | 61 x 30 mm | 0,07 l |
| 07-1132 | 80 x 40 mm | 0,14 l |
| 07-1133 | 116 x 50 mm | 0,35 l |
| 07-1134 | 128 x 55 mm | 0,45 l |
| ▶ 07-1135 | 147 x 65 mm | 0,70 l |
| 07-1136 | 167 x 75 mm | 1,10 l |
| 07-1137 | 187 x 85 mm | 1,60 l |



| | | |
|-----------|-------------|--------|
| 07-1140 | 116 x 35 mm | 0,30 l |
| 07-1141 | 128 x 38 mm | 0,40 l |
| ▶ 07-1142 | 147 x 40 mm | 0,50 l |
| 07-1143 | 157 x 45 mm | 0,75 l |
| 07-1144 | 187 x 45 mm | 1,00 l |

Runde Schalen
Round bowls
Cubetas redondas
Cupules
Scodelle rotonde



Nierenschalen
Kidney Bowls
Cuñas
Bassins réniformes
Bacinelle reniformi

Dreieckschalen
Triangular Basins
Cubetas triangulares
Bassins triangulaires
Bacinelle triangolari

Stechbecken
Bed Pan
Cubetas
Bassins de lit
Padelle

Abmessungen (L x B x H)
Sizes (l x w x h)
Tamaños (l x f x a)
Dimensions (lo. x hau. x la.)
Dimensioni (L x l x h)



07-0930 170 x 100 x 35 mm
07-0931 200 x 100 x 40 mm
▶ 07-0932 250 x 140 x 40 mm
07-0933 275 x 150 x 45 mm

Nierenschalen
Kidney bowls
Cuñas
Bassins réniformes
Bacinelle reniformi



07-0936

Dreieckschale
Triangular basin
Cubeta triangulares
Bassin triangulaires
Bacinelle triangolari



07-0938

Dreieckschale
Triangular basin
Cubeta triangulares
Bassin triangulaires
Bacinelle triangolari



07-0942 ø 235 mm
▶ 07-0944 ø 310 mm

Stechbecken, mit Knopfdeckel
Bed pan, lid with knob
Cubetas, tapa con botón
Bassin de lit
Padelle, coperchio con bottone



07-0952 1/2
 25 cc
 Medizinbecher
 Medicine cup
 Vaso graduado
 Gobelet
 Bicchiere per medicinali



07-0953 1/2
 50 cc
 Medizinbecher
 Medicine cup
 Vaso graduado
 Gobelet
 Bicchiere per medicinali



07-0954 1/2
 20 cc
 Medizinlöffel
 Medicine spoon
 Cuchara graduada
 Cuillère pour médicaments
 Cucchiato per medicinali



07-0957 1/3
 ø 92 x 87 mm
 Sputumbecher
 Sputum cup
 Escupideras
 Crachoir
 Sputacchiera



07-0958 1/3
 ø 100 x 60 mm
 Zahnprothesenschale
 Bowl for dentures
 Tarro para prótesis dental
 Récipient à prothèses dentaires
 Recipienti per protesi dentarie



07-0964 ø 100 mm
 ▶ 07-0965 ø 120 mm
 07-0966 ø 150 mm
 07-0967 ø 200 mm
 07-0968 ø 240 mm
 Trichter
 Funnels
 Embudos
 Entonnoirs
 Imbuti



07-0990 1,0 l
 07-0991 1,5 l
 ▶ 07-0992 2,0 l
 Irrigatoren
 Irrigators
 Irrigadores
 Irrigateurs
 Irrigatori



07-1030 0,5 l
 07-1031 1,0 l
 ▶ 07-1032 1,5 l
 Messbecher
 Measuring jugs
 Copa graduada
 Gobelets gradués
 Misurino graduato



07-1034 0,25 l
 07-1035 0,50 l
 07-1036 1,00 l
 ▶ 07-1037 1,50 l
 07-1038 2,00 l
 Messbecher
 Measuring jugs
 Copa graduada
 Gobelets gradués
 Misurino graduato



Handwaschbürste
Nailbrush
Cepillo de uñas
Brosse à ongles
Spazzola per unghie

Bürstenspender
Brush Dispensers
Distribuidores de cepillos
Distributeurs de brosses
Distributori di spazzole



1/2

07-2000

Handwaschbürste, über 400 Mal im Autoklaven sterilisierbar
Nailbrush, more than 400 times autoclavable
Cepillo de uñas, esterilizable más de 400 veces en autoclave
Brosse à ongles, stérilisable à l'autoclave 400 fois ou plus
Spazzola per unghie, sterilizzabile più di 400 volte in autoclave



1/4

► 07-2002 260 x 155 x 65 mm

Bürstenspender für 10 Bürsten (ohne Bürsten), mit Aufhängevorrichtung (07-2003)

Brush dispenser for 10 brushes (without brushes), with suspension hook (07-2003)

Distribuidor de cepillos para 10 cepillos (sin cepillos), completo con gancho de suspensión (07-2003)

Distributeur pour 10 brosses (sans brosses), avec crochet de suspension (07-2003)

Distributore per 10 spazzole (spazzole escluse), con gancio di sospensione (07-2003)

07-2004 260 x 155 x 65 mm

Bürstenspender für 10 Bürsten (ohne Bürsten), ohne Aufhängevorrichtung

Brush dispenser for 10 brushes (without brushes), without suspension hook

Distribuidor de cepillos para 10 cepillos (sin cepillos), sin gancho de suspensión

Distributeur pour 10 brosses (sans brosses), sans crochet de suspension

Distributore per 10 spazzole (spazzole escluse), senza gancio di sospensione



1/4

► 07-2006 270 x 240 x 65 mm

Bürstenspender für 20 Bürsten (ohne Bürsten), mit Aufhängevorrichtung (07-2007)

Brush dispenser for 20 brushes (without brushes), with suspension hook (07-2007)

Distribuidor de cepillos para 20 cepillos (sin cepillos), completo con gancho de suspensión (07-2007)

Distributeur pour 20 brosses (sans brosses), avec crochet de suspension (07-2007)

Distributore per 20 spazzole (spazzole escluse), con gancio di sospensione (07-2007)

07-2008 270 x 240 x 65 mm

Bürstenspender für 20 Bürsten (ohne Bürsten), ohne Aufhängevorrichtung

Brush dispenser for 20 brushes (without brushes), without suspension hook

Distribuidor de cepillos para 20 cepillos (sin cepillos), sin gancho de suspensión

Distributeur pour 20 brosses (sans brosses), sans crochet de suspension

Distributore per 20 spazzole (spazzole escluse), senza gancio di sospensione



1/4

► 07-2010
205 x 185 x 135 mm

Bürsten-Abwurfbehälter mit Aufhänge-
vorrichtung (07-2011)

Brush collecting container, with suspension
hook (07-2011)

Caja para depositar cepillos, con gancho
de suspensión (07-2011)

Boîte pour déposer des brosses à ongles,
avec crochet de suspension (07-2011)

Contentitore per spazzole usate, con gancio
di sospensione (07-2011)

07-2012
205 x 185 x 135 mm

Bürsten-Abwurfbehälter ohne Aufhänge-
vorrichtung

Brush collecting container, without suspension
hook

Caja para depositar cepillos, sin gancho
de suspensión

Boîte pour déposer des brosses à ongles,
sans crochet de suspension

Contentitore per spazzole usate, senza gancio
di sospensione



1/4

07-2014
250 x 150 x 150 mm

Bürstenablagekorb
Brush collecting basket
Cesta para cepillos
Panier pour brosses
Castello per spazzole



Wasserstrahlreinigungspistole mit Aufsätzen
Water Jet Pistol with Several Tips
Pistola-lavatoria de chorro de agua con varias toberas
Pistolet-laveur à jet d'eau avec plusieurs embouts
Pistola a getto d'acqua con vari raccordi



07-2100

Wasserstrahlreinigungspistole, komplett, bestehend aus:

- 07-2102 1 Wasserstrahlreinigungspistole
- 07-2104 1 Reinigungsaufsatz für Flaschen
- 07-2106 1 Reinigungsaufsatz für RECORD Spritzen-Konen
- 07-2108 1 Reinigungsaufsatz für Katheter
- 07-2110 1 Reinigungsaufsatz für Drainageschläuche
- 07-2112 1 Reinigungsaufsatz für Hohlgefäße (Brause)
- 07-2114 1 Reinigungsaufsatz für Kanülen mit RECORD Konus
- 07-2116 1 Reinigungsaufsatz für Kanülen mit LUER Konus
- 07-2118 1 Reinigungsaufsatz für Meß- und Vollpipetten
- 07-2120 1 Reinigungsaufsatz für feine Pipetten (Ery/Leuco)
- 07-2122 1 Aufsteckleiste
- 07-2124 1 Druckschlauch, 1 m
- 07-2126 1 Schelle
- 07-2128 1 Aufhängehaken für Pistole

1/3

Water jet pistol, complete, consisting of:

- 07-2102 1 Water jet pistol
- 07-2104 1 Cleaning tip for bottles
- 07-2106 1 Cleaning tip for cones of RECORD syringes
- 07-2108 1 Cleaning tip for catheters
- 07-2110 1 Cleaning tip for drainage tubings
- 07-2112 1 Cleaning tip for receptacles (shower)
- 07-2114 1 Cleaning tip for hypodermic needles with RECORD cone
- 07-2116 1 Cleaning tip for hypodermic needles with LUER conus
- 07-2118 1 Cleaning tip for measure and volumetric pipettes
- 07-2120 1 Cleaning tip for fine pipettes (Ery/Leuco)
- 07-2122 1 Storing rack
- 07-2124 1 Pressure tubing, 1 m
- 07-2126 1 Strap
- 07-2128 1 Suspension hook for pistol

Pistola-lavatoria de chorro de agua, completo, compuesto de:

- 07-2102 1 Pistola-lavatoria de chorro de agua
- 07-2104 1 Tobera para botellas
- 07-2106 1 Tobera para conos de jeringas RECORD
- 07-2108 1 Tobera para catéteres
- 07-2110 1 Tobera para tubos de drenaje
- 07-2112 1 Tobera para recipientes (ducha)
- 07-2114 1 Tobera para agujas de inyección con cono RECORD
- 07-2116 1 Tobera para agujas de inyección con cono LUER
- 07-2118 1 Tobera para pipetas de medida y volumétricas
- 07-2120 1 Tobera para pipetas finas (eritrocito/leucocito)
- 07-2122 1 Sujetador
- 07-2124 1 Tubo de presión de 1 m
- 07-2126 1 Abrazadera
- 07-2128 1 Gancho de suspensión para pistola

Pistolet-laveur à jet d'eau, complet, composée de:

- 07-2102 1 Pistolet-laveur à jet d'eau
- 07-2104 1 Embout de rinçage pour bouteilles
- 07-2106 1 Embout de rinçage pour raccords de seringues RECORD
- 07-2108 1 Embout de rinçage pour sondes
- 07-2110 1 Embout de rinçage pour sondes à drainage
- 07-2112 1 Embout de rinçage pour vases (douche)
- 07-2114 1 Embout de rinçage pour aiguilles hypodermiques avec raccord RECORD
- 07-2116 1 Embout de rinçage pour aiguilles hypodermiques avec raccord LUER
- 07-2118 1 Embout de rinçage pour pipettes ordinaires et de précision
- 07-2120 1 Embout de rinçage pour pipettes fines (erythro/leuco)
- 07-2122 1 Support (pour embouts)
- 07-2124 1 Tuyau à haute pression en caoutchouc, 1 m
- 07-2126 1 Agrafe
- 07-2128 1 Crochet de suspension

Pistola a getto d'acqua, completa, composta da:

- 07-2102 1 Pistola a getto d'acqua
- 07-2104 1 Raccordo di lavaggio per bottiglie
- 07-2106 1 Raccordo di lavaggio per coni di siringhe RECORD
- 07-2108 1 Raccordo di lavaggio per cateteri
- 07-2110 1 Raccordo di lavaggio per tubi di drenaggio
- 07-2112 1 Raccordo di lavaggio per recipienti (doccia)
- 07-2114 1 Raccordo di lavaggio per aghi ipodermici con cono RECORD
- 07-2116 1 Raccordo di lavaggio per aghi ipodermici con cono LUER
- 07-2118 1 Raccordo di lavaggio per pipette comuni e graduate
- 07-2120 1 Raccordo di lavaggio per pipette fini (eritro/leuco)
- 07-2122 1 Rastrelliera
- 07-2124 1 Tubo ad alta pressione, 1 m
- 07-2126 1 Graffa
- 07-2128 1 Gancio di sospensione per pistola

Aufsätze für Wasserstrahlreinigungspistole
 Tips for Water Jet Pistol
 Toberas para pistola-lavatoria de chorro de agua
 Embouts pour pistolet-laveur à jet d'eau
 Raccordi per pistola a getto d'acqua



07-2104

Reinigungsaufsatz für Flaschen
 Cleaning tip for bottles
 Tobera para botellas
 Embout de rinçage pour bouteilles
 Raccordo di lavaggio per bottiglie



07-2106

Reinigungsaufsatz für RECORD Spritzen-Konen
 Cleaning tip for cones of RECORD syringes
 Tobera para conos de jeringas RECORD
 Embout de rinçage pour raccords de seringues RECORD
 Raccordo di lavaggio per coni di siringhe RECORD



07-2108

Reinigungsaufsatz für Katheter
 Cleaning tip for catheters
 Tobera para catéteres
 Embout de rinçage pour sondes
 Raccordo di lavaggio per cateteri



07-2110

Reinigungsaufsatz für Drainageschläuche
 Cleaning tip for drainage tubings
 Tobera para tubos de drenaje
 Embout de rinçage pour sondes à drainage
 Raccordo di lavaggio per tubi di drenaggio



07-2112

Reinigungsaufsatz für Hohlgefäße (Brause)
 Cleaning tip for receptacles (shower)
 Tobera para recipientes (ducha)
 Embout de rinçage pour vases (douche)
 Raccordo di lavaggio per recipienti (doccia)



07-2114

Reinigungsaufsatz für Kanülen mit RECORD Konus
 Cleaning tip for hypodermic needles with RECORD cone
 Tobera para agujas de inyección con cono RECORD
 Embout de rinçage pour aiguilles hypodermiques avec raccord RECORD
 Raccordo di lavaggio per aghi ipodermici con cono RECORD



07-2116

Reinigungsaufsatz für Kanülen mit LUER Konus
 Cleaning tip for hypodermic needles with LUER cone
 Tobera para agujas de inyección con cono LUER
 Embout de rinçage pour aiguilles hypodermiques avec raccord LUER
 Raccordo di lavaggio per aghi ipodermici con cono LUER



07-2118

Reinigungsaufsatz für Meß- und Vollpipetten
 Cleaning tip for measure and volumetric pipettes
 Tobera para pipetas de medida y volumétricas
 Embout de rinçage pour pipettes ordinaires et de précision
 Raccordo di lavaggio per pipette comuni e graduate



07-2120

Reinigungsaufsatz für feine Pipetten (Ery/Leuco)
 Cleaning tip for fine pipettes (Ery/Leuco)
 Tobera para pipetas finas (eritrocito/leucocito)
 Embout de rinçage pour pipettes fines (erythro/leuco)
 Raccordo di lavaggio per pipette fini (eritro/leuco)

07-2130
 31 cm, 12 1/4"



Reinigungsaufsatz, gerade
 Cleaning tip, straight
 Tobera de limpieza, recta
 Embout de rinçage, droit
 Raccordo di lavaggio, retto

07-2132
 30 cm, 12"



Reinigungsaufsatz, aufgebogen
 Cleaning tip, curved
 Tobera de limpieza, curva
 Embout de rinçage, courbe
 Raccordo di lavaggio, curvo









07-2134

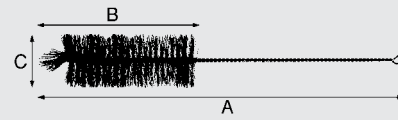



Überwurfmutter zum Anschluß an Gewindehähne,
 1/2 Zoll
 Coupling for connection to water tap, 1/2 inch
 Tuercas-hembras para conexión al grifo de agua,
 1/2 pulgada
 Ecrous-raccord pour la connexion aux robinets à filet
 Raccordi per connessione ai rubinetti filettati



Reinigungsbürsten
 Cleaning Brushes
 Cepillos de limpieza
 Ecouvillons
 Spazzole per pulizia



| | | | | | |
|---|---|---|---|---|---|
| |  |  |  |  |  |
| | 07-2020 | 07-2022 | 07-2024 | 07-2026 | 07-2028 |
| A | 215 mm | 215 mm | 215 mm | 215 mm | 215 mm |
| B | 60 mm | 65 mm | 95 mm | 95 mm | 100 mm |
| C | 13 mm | 15 mm | 20 mm | 25 mm | 28 mm |

| | | | | | |
|---|---|---|---|---|---|
| |  |  |  |  |  |
| | 07-2030 | 07-2032 | 07-2034 | 07-2036 | 07-2038 |
| A | 265 mm | 430 mm | 285 mm | 265 mm | 330 mm |
| B | 65 mm | 65 mm | 75 mm | 65 mm | 130 mm |
| C | 3 mm | 3 mm | 7 mm | 8 mm | 50 mm |



1/2

07-2150
 13,5 cm, 5 1/4"

Schreib- und Markierungsstift mit Schraubkappe, auswechselbarem, beidseitig spitzem Hartmetallstift (07-2151)

Writing and marking pencil with screw cap, interchangeable writing pin of hard metal (07-2151)

Lápiz para marcar y escribir con tuerca tapón, punta de carburo tungsteno intercambiable (07-2151)

Crayon pour marquer et écrire, avec écrou-chapeau et pointe en métal dur interchangeable (07-2151)

Lapis per marcare e scrivere con coperchio a vite, e punta di metallo duro intercambiabile (07-2151)



1/2

07-2152
 14 cm, 5 1/2"

Schreib- und Markierungsstift mit Hartmetallstift (07-2153)

Writing and marking pencil with hard metal pin (07-2153)

Lápiz para marcar y escribir con punta de carburo tungsteno (07-2153)

Crayon pour marquer et écrire et pointe en métal dur (07-2153)

Lapis per marcare e scrivere e punta di metallo duro (07-2153)



1/2

07-2154
 14 cm, 5 1/2"

Schreib- und Markierungsstift mit Hartmetallstift (07-2153) und Lupe

Writing and marking pencil with hard metal pin (07-2153) and magnifying glass

Lápiz para marcar y escribir con punta de carburo tungsteno (07-2153) y lupa

Crayon pour marquer et écrire et pointe en métal dur (07-2153) et loupe

Lapis per marcare e scrivere, punta di metallo duro (07-2153) e lente d'ingrandimento



1/2

07-2156
 220 V / 50 Hz

Elektrisches Schreib- und Markierungsgerät mit Netzanschlusskabel und auswechselbarem Hartmetallstift (07-2153), mit Druckknopfschalter, Gewicht ca. 350 g

Electric writing and marking apparatus with connection cable and interchangeable hard metal pin (07-2153), with push-button switch, weight 350 g approx.

Aparato eléctrico para marcar y escribir, con cable de conexión y punta de carburo tungsteno intercambiable (07-2153), con interruptor de botón, peso 350 g

Appareil électrique pour marquer et écrire, avec câble de connexion et pointe en métal dur interchangeable (07-2153), avec interrupteur à bouton de pression, poids 350 grs. approx.

Apparecchio elettrico per marcare e scrivere, con cavo di connessione e punta di metallo duro intercambiabile, con interruttore a bottone (07-2153), peso 350 g ca.



Notizen

Notes

Notas

Notes

Note

A

Abfallzange 735
 Abnehmezangen für Klammern 691
 Abortusküretten 484
 Abortuslöffel 484
 Abortuszangen 482-483
ABRAMS Kanüle zur Brustfellpunktion 329, 518
 Absaugküretten 471
 Absaugrohr-Mikro 321
ADAIR-ALLIS Darm- und Gewebefäßzange 384
ADAIR Hakenzange 452
ADAMS-MAYO Appendektomie-Wundspreizer 284
ADLERKREUTZ Gefäß- und Tumorzangen 148
 Adnexscheren DURACUT 54
ADSON-ANDERSON Wundspreizer 276
ADSON-BABY Präparier- und Ligaturklammern 180
ADSON-BECKMANN Laminektomie-Wundspreizer 279
ADSON-BROWN Feine chirurgische Pinzetten 141
ADSON-BROWN TITE GRIP Chirurgische Pinzette 117
ADSON-MICRO Feine anatomische Pinzetten 129
ADSON-MICRO Feine chirurgische Pinzetten 140-141
ADSON-MICRO TITE GRIP Chirurgische Pinzetten 117
ADSON-TOENNIS DURACUT Präparierscheren 49
ADSON-TOENNIS Präparierscheren 89
ADSON Bohrer 652
ADSON Bohrerführungs- und Dura-Schutzzange 650
ADSON Feine anatomische Pinzetten 129
ADSON Feine Arterienklammern 169
ADSON Feine chirurgische Pinzetten 140-141
ADSON Hemilaminektomie-Wundspreizer 277
ADSON Laminektomie-Wundspreizer 276, 280
ADSON Nadelhalter 367
ADSON Nerv- und Gefäßhaken 215
ADSON Raspatorien 586
ADSON Saugkanülen 323
ADSON TITE GRIP Anatomische Pinzetten 113
ADSON TITE GRIP Chirurgische Pinzetten 117
ADSON Wundspreizer 273, 278
ALAN-PARK Analspreizer 408
ALDERDYCE Dissektor 574
ALDINGER-HOHMANN Knochenheber 580
ALEXANDER-FARABEUF Rippenraspatorien 497
ALEXANDER Flachmeißel 609
ALEXANDER Hohlmeißel 609
ALEXANDER Osteotome 609
ALEXANDER Uterus-Biopsiezange 463
 Algesimeter 4
ALLEN Darmklammern 390
ALLIS-ADAIR Darm- und Gewebefäßzange 384
ALLIS-BABY Darm- und Gewebefäßzangen 383
ALLIS-BOYS Darm- und Gewebefäßzange 384
ALLIS-JUDD Darm- und Gewebefäßzangen 384
ALLIS-OCHSNER Darm- und Gewebefäßzange 383
ALLIS-THOMS Darm- und Gewebefäßzange 385
ALLIS ATRAUMATIC-GRIP Darm- und Gewebefäßzangen 389
ALLIS Darm- und Gewebefäßzangen 383-385
ALLISON Lungenspatel 260
ALM Wundspreizer 270
ALY Algesimeter 4
AMANN Tamponadeführer 447
 Amnioskop-Tuben 472
 Amniotom 477
 Amputationsmesser 38-39
 Amputationsretraktoren 571
 Amputationssägen 572-573
 Analsonden 409
 Analspreizer 407-408
 Anastomosen- (Vena Cava) Klammern 565
 Anastomosenklammern 400-402
 Anastomosenklammern ATRAUMATIC-GRIP 400-401, 520-523, 542-544, 559-560
 Anatomische Pinzetten 132-134
 Anatomische Pinzetten fein 128-131
 Anatomische Pinzetten TITE GRIP 113-115
ANDERSON-ADSON Wundspreizer 276
ANDREW-PYNCHON Saugrohr 325
 Anlegepinzetten für Gefäßclips 154, 156

Anlegezange für Approximatoren 158
 Anlegezange für Bulldogklammern 527
 Anlegezange für Gefäßclips 155
 Anlegezange für TITAN-LINE Bulldogklammern 160
 Anlegezangen für Klammern 690-691
 Anuskope 407
 Aorta-Anastomosenklammern ATRAUMATIC-GRIP 548-549
 Aorta-Aneurysmaklammern ATRAUMATIC-GRIP 545-547, 561
 Aorta-Dilatatoren 511
 Aortaklammern ATRAUMATIC-GRIP 537-540, 561
 Appendektomie-Wundspreizer 284
 Appendektomieklammer 403
 Approximatoren 157-159
ARMYTAGE-GREEN Uterusklemmzange 481
 Arterienklammern 173-179
 Arterienklammern ATRAUMATIC-GRIP 176
 Arterienklammern ATRAUMATIC-GRIP fein 165, 167
 Arterienklammern fein 164-172
 Arterienklammern TITAN-LINE fein 164, 166, 168
 Arteriotomieschere 95
ARTHUR Splitterzange 151
 Ästhesiometer 4
 ATRAUMATIC-GRIP Anastomosenklammern 400-401, 520-523, 542-544, 559-560
 ATRAUMATIC-GRIP Aorta-Aneurysmaklammern 545-547, 561
 ATRAUMATIC-GRIP Aorta-Anastomosenklammern 548-549
 ATRAUMATIC-GRIP Aortaklammern 537-540, 561
 ATRAUMATIC-GRIP Arterienklammern 176
 ATRAUMATIC-GRIP Bronchusklammern 552
 ATRAUMATIC-GRIP Bulldogklammern 525-528, 556
 ATRAUMATIC-GRIP Coarctationsklammern 532-533, 557
 ATRAUMATIC-GRIP Darmfäßzangen 389
 ATRAUMATIC-GRIP Darmklammern 391-393, 395-396
 ATRAUMATIC-GRIP Feine Arterienklammern 165, 167
 ATRAUMATIC-GRIP Gefäßklammern 520-523, 529-530, 534, 537, 541, 555-556, 558, 561-562
 ATRAUMATIC-GRIP Gefäßpinzetten 135
 ATRAUMATIC-GRIP Gewebefäßzangen 389
 ATRAUMATIC-GRIP Hysterektomieklammern 197
 ATRAUMATIC-GRIP Iliaca Klammern 558
 ATRAUMATIC-GRIP Karotis-Klammern 524, 527, 537
 ATRAUMATIC-GRIP Ligaturklammern 186, 551
 ATRAUMATIC-GRIP Magenklammern 397
 ATRAUMATIC-GRIP Mehrzweckklammern 520-523, 530, 553-554, 556, 562
 ATRAUMATIC-GRIP Nierenarterienklammern 537, 558
 ATRAUMATIC-GRIP Nierenklammern 190
 ATRAUMATIC-GRIP Obere Verschlussklammer 398
 ATRAUMATIC-GRIP Parametriumklammern 197
 ATRAUMATIC-GRIP Patent-Ductusklammern 531, 556
 ATRAUMATIC-GRIP Peripheralklammern 534-536, 558
 ATRAUMATIC-GRIP Präparierklammern 186, 551
 ATRAUMATIC-GRIP Profundaklammern 534
 ATRAUMATIC-GRIP Rektumklammern 400-401
 ATRAUMATIC-GRIP Untere Verschlussklammern 399
 ATRAUMATIC-GRIP Vena-Cava-Klammern 550
 Atriumhaken 509
AUFRICHT Raspeln 593
AUFRICHT Scheren für plastische Chirurgie 82
 Augennadeln 354
 Aurikelklammern 564
AUSTIN Mikro-Knüpfpinzetten 122
AUVARD-BERLIND Scheidenspekulum 441
AUVARD Scheidenspekula 441

B

BABCOCK ATRAUMATIC-GRIP Darm- und Gewebefäßzangen 389
BABCOCK Darm- und Gewebefäßzangen 385
BABCOCK TITE GRIP Darm- und Gewebefäßzangen 388
BABY-ADSON Präparier- und Ligaturklammern 180
BABY-ALLIS Darm- und Gewebefäßzangen 383
BABY-BAILEY Rippenkontraktor 508
BABY-BALFOUR Bauchdeckenhalter 300
BABY-COLLIN Bauchdeckenhalter 297
BABY-CRILE Feine Arterienklammern 166
BABY-DOYEN ATRAUMATIC-GRIP Darmklammern 391
BABY-DOYEN Darmklammern 391

| | | | |
|--|--------------|--|----------|
| BABY-FINOCHIETTO Rippensperrerr | 503 | BERLIND-AUVARD Scheidenspekulum | 441 |
| BABY-GELPI Vulva-Spreizer | 281 | BERLINER Perkussionshammer | 2 |
| BABY-GILLIES Nadelhalter | 370 | BERNHARD Tuchklemme | 201 |
| BABY-GILLIES TITE GRIP Nadelhalter | 348 | Beschneidungs-Instrumente | 426 |
| BABY-GOSSET Bauchdeckenhalter | 299 | BETHUNE Rippenschere | 493 |
| BABY-HAIGHT-FINOCHIETTO Rippensperrerr aus ALUMINIUM | 501 | BEYER Hohlmeißelzangen | 632-633 |
| BABY-KELLY Feine Arterienklemmen | 168 | BEYER Laminektomie-Stanzen | 707 |
| BABY-KOCHER ATRAUMATIC-GRIP Darmklemmen | 391 | BIEMER-MÜLLER Approximatoren | 157 |
| BABY-KOCHER Darmklemmen | 391 | BIEMER Gefäßclips | 156 |
| BABY-LEXER Präparierscheren | 87 | BIEMER Venenschere | 63 |
| BABY-MEEKER Präparier- und Ligaturklemmen | 180 | BIER Amputations- und Resektionssäge | 573 |
| BABY-METZENBAUM Präparierscheren | 89 | BILL Zughebel für Geburtszangen | 479 |
| BABY-MIKULICZ Peritoneumklemme | 192 | Binde, Stau- | 570 |
| BABY-MIXTER Präparier- und Ligaturklemmen | 180 | Binokulare Kopflupen | 8-9 |
| BABY-MOSQUITO (HARTMANN) Feine Arterienklemmen | 164 | Binokulare Lupenbrille | 9 |
| BABY-OLSEN-HEGAR TITE GRIP Nadelhalter | 348 | Biopsieinstrumentarium für Wirbelkörper | 720-721 |
| BABY-OVERHOLT Präparier- und Ligaturklemme | 183 | Biopsiekanülen | 329, 518 |
| BABY-PAYR Darm- und Magenquetschklemme | 403 | Biopsieküretten | 459-460 |
| BABY-ROUX Wundhaken | 228 | Biopsiezangen, Mastdarm- | 412 |
| BABY-SATINSKY Anastomosen- (Vena Cava) Klemme | 565 | Biopsiezangen, Uterus- | 460-465 |
| BABY-TISCHLER Uterus-Biopsiezange | 464 | BIRCHER-GANSKE Meniskus- und Knorpelfaßzangen | 640 |
| BACKHAUS Tuchklemmen | 201 | BIRCHER Meniskussmesser | 643 |
| BADGLEY Laminektomie-Spreizer | 286 | BLAKE-MAYO Gallensteinzangen | 418 |
| BAHNSON-DE BAKEY ATRAUMATIC-GRIP Aorta-Aneurysmaklemmen | 545 | BLAKE Gallensteinzangen | 418 |
| BAILEY-BABY Rippenkontraktor | 508 | BLAKE Uteruskürette | 466 |
| BAILEY-GIBBON Rippenkontraktor | 508 | BLAKESLEY-WEIL Laminektomie-Zangen | 714 |
| BAILEY (DE MARTEL) Einführungsinstrument für Drahtsägen | 687 | Blasenhalsspreizer | 423 |
| BAILEY ATRAUMATIC-GRIP Aortaklemmen | 538 | Blasenspatel | 268 |
| BAILEY Rippenkontraktor | 508 | Blasensprenger | 477 |
| BAINBRIDGE-DE BAKEY ATRAUMATIC-GRIP Gefäßklemmen | 530 | Blasenspritzen | 331 |
| BAINBRIDGE Darmklemmen | 390 | Blasenwundspreizer | 310 |
| BAKES Gallengang-Dilatationsoliven | 416 | Bleihände | 644 |
| BALFOUR-BABY Bauchdeckenhalter | 300 | BLESSING DURACUT Schere für Rektumchirurgie | 59 |
| BALFOUR-KIRSCHNER Valven für Bauchdeckenhalter | 307 | BLOUNT Hüfthebel | 580 |
| BALFOUR Bauchdeckenhalter | 300-303 | BLOUNT Wund- und Meniskushaken | 641 |
| BALFOUR Valven für Bauchdeckenhalter | 303 | BLUMENTHAL Hohlmeißelzangen | 631 |
| BALLENGER-FOERSTER Tupfer- und Schwammzangen | 209 | BLUNT Sterilisierklammer | 736 |
| BALLENTINE-HEANEY Hysterektomieklammer | 196 | BOETTCHER Tonsillenschere | 103 |
| BALLENTINE Hysterektomieklammer | 196 | BÖHLER (WALTON-LISTON) Knochensplitterzangen | 638 |
| BARNES Saugkanüle | 321 | BÖHLER Extensionsbügel | 654 |
| BARR Analspreizer | 408 | BÖHLER Hohlmeißelzangen | 633 |
| BARRAQUER-TROUTMAN Mikro-Nadelhalter | 360 | Bohrapparate, Hand- | 651-653 |
| BARRAQUER Cilienpinzette | 152 | Bohrdrähte | 655 |
| BARRAQUER Mikro-Nadelhalter | 360 | Bohrdrahtspender | 656 |
| BARRAYA-STILLE Gefäß- und Tumorpinzetten | 148 | Bohrdrahtspender-Mehrfach | 657 |
| BARRETT Hakenzange | 452 | Bohrer | 652 |
| BARTH Scharfer Löffel | 599 | Bohrer, Nagel- | 645 |
| Bauchdeckenhaken | 309, 248-249 | Bohrerführungsinstrument | 650 |
| Bauchdeckenhalter | 297-309 | Bolzenschneider | 668 |
| Bauchdeckenscheren | 106 | BONN MOD. Feine chirurgische Pinzetten | 138 |
| Bauchspatel | 266-267 | BONNEY Anatomische Pinzette | 134 |
| BAUMGARTNER-HEGAR TITE GRIP Nadelhalter | 342 | BONNEY Chirurgische Pinzetten | 147 |
| BAUMGARTNER Nadelhalter | 366 | BONNEY TITE GRIP Anatomische Pinzette | 115 |
| BAUMGARTNER TITE GRIP Nadelhalter | 342 | BONNEY TITE GRIP Chirurgische Pinzette | 118 |
| BEACHAM Amniotom | 477 | BOSE Trachealhäkchen | 728 |
| BECK-COOLEY ATRAUMATIC-GRIP Anastomosenklemmen | 560 | Bougies, Dilatations- | 424 |
| BECK-DE BAKEY ATRAUMATIC-GRIP Anastomosenklemmen | 543 | BOYS-ALLIS Darm- und Gewebefaßzange | 384 |
| BECK-DE BAKEY ATRAUMATIC-GRIP Aortaklemmen | 537 | BOZEMANN-DOUGLAS Tamponzangen | 208 |
| BECK-DE BAKEY ATRAUMATIC-GRIP Vena-Cava-Klemmen | 550 | BOZEMANN (WERTHEIM) TITE GRIP Nadelhalter | 346 |
| Becken, Stech- | 750 | BOZEMANN Tamponzangen | 208 |
| Beckenzirkel | 477 | BRAND Sehnenführungszangen | 648 |
| BECKMANN-ADSON Laminektomie-Wundspreizer | 279 | BRAUN-SIMPSON Geburtszangen | 478 |
| BECKMANN-EATON Laminektomie-Wundspreizer | 280 | BRAUN-STADLER Damm- (Episiotomie-) Scheren | 107 |
| BECKMANN Laminektomie-Wundspreizer | 280 | BRAUN Dekapitationshaken | 485 |
| BEEBEE Drahtscheren | 665 | BRAUN Hakenzangen | 452, 454 |
| BEER Cilienpinzette | 152 | BRAUN Kranioklast | 485 |
| Behälter, Bereitschafts- | 738 | BRAUN Uterus-Depressor | 447 |
| Behälter, Sterilisier- | 738-742 | BRAWLEY Raspel | 593 |
| Beinhautmesser | 39 | BREISKY Scheidenspekula | 438, 440 |
| BELMONT-RUMEL Tourniquets | 518 | BRIDGE Präparier- und Ligaturklemme | 187 |
| BENGOLEA Feine Arterienklemmen | 172 | BRINKERHOFF Mastdarm-Rektum-Spekula | 406 |
| BENNETT Knochenhebel | 581 | Bronchusklemmen | 566 |
| BENSON Pyloruspreizer | 403 | Bronchusklemmen ATRAUMATIC-GRIP | 552 |
| Bereitschaftsbehälter | 738 | BROPHY (SULLIVAN) Feine Präparierscheren | 93 |
| Bereitstellungsbecher | 737 | BROPHY Feine anatomische Pinzetten | 130 |
| BERGER Binokulare Kopflupen | 8 | BROPHY Feine chirurgische Pinzetten | 143 |
| BERGER Uterus-Biopsiezangen | 462 | BROWN-ADSON Feine chirurgische Pinzetten | 141 |
| BERGMANN Hämmer | 621 | BROWN-ADSON TITE GRIP chirurgische Pinzette | 117 |
| BERGMANN Kleiderstoff- und Gippscheren | 675 | BROWN Gewebefaßpinzetten | 148 |

BROWN Nadelhalter 366
BROWNE-DENIS Bauchdeckenhalter 305
BRUENINGS Zungenspatel 12
BRUNNER Rektum-Anastomosenklemme 400
BRUNNER Wundhaken 252-253
BRUNS DURACUT Gipsschere 676
BRUNS Gipsscheren 676
BRUNS Scharfe Löffel 602-603
BUCHWALD Zungenspatel 12
BUCK-GRAMCKO Knochenheber 576
BUCK Perkussionshammer 3
BUELAU Trokar 318
BUIE-SMITH Analspreizer 408
BUIE Druckklemme 409
 Bulbus-Haken 422
 Bulldogklemmen 163
 Bulldogklemmen ATRAUMATIC-GRIP 525-528, 556
 Bulldogklemmen aus TITAN 160-161
 Bulldogklemmen Mikro 162
 Bumerang-Nadelhalter 372
BUMM Plazentar- und Abortusküretten 484
BUMM Uterusküretten 470
BUNNELL Handbohrapparat 653
BUNNELL Sehnenführer 646
BUNNELL Sehnenschäler 646
BURFORD-FINOCCHIETTO Rippensperrer 503
BURFORD-FINOCCHIETTO Rippensperrer aus ALUMINIUM 502
BURKE Uterus-Biopsiezange 464
 Bürsten, Handwasch- 752
 Bürsten, Reinigungs- 756
 Bürstenablagekörbe 753
 Bürstspender 752
BUSH Nabelschnurscheren 108

C

CALNE ATRAUMATIC-GRIP Vena-Cava-Klemme 550
CANAD. MODELL Meniskusmesser 643
CANNON Endarterektomie-Satz 515
CANNON Endarterektomiestripper 514
CANNON Intima-Messer 513
CANNON Intima-Spatel 513
CAPLAN DURACUT Septumschere 59
CARMALT-ROCHESTER Arterienklemmen 178
CAROTIS-DE BAKEY ATRAUMATIC-GRIP Bulldogklemmen 525
 Carpal- Tunnel-Wundspreizer 271
CARROLL Nadelhalter 366
CARROLL Sehnenführungsange 648
CARROLL TITE GRIP Nadelhalter 344
CASPAR Explorations- und Koagulationshäkchen 215
CASPAR Laminektomie-Zangen 718-719
CASPAR Raspatorien 585
CASPAR Spekula für lumbale Bandscheibenoperationen 295
CASPAR Wundhaken 245
CASPAR Wundspreizer für die Wirbelsäule 288, 290-292, 294
CASTANEDA ATRAUMATIC-GRIP Anastomosenklemmen 520
CASTANEDA ATRAUMATIC-GRIP Mehrzweckklemmen 520
CASTANEDA Rippensperrer aus ALUMINIUM 500
CASTROVIEJO-MICRO Nadelhalter 358
CASTROVIEJO Feine chirurgische Pinzetten 138
CASTROVIEJO Nadelhalter 363
CASTROVIEJO Rasierklingen-Halter und -Brecher 36
CASTROVIEJO TITE GRIP Mikro-Nadelhalter 338-339
CASTROVIEJO Zirkel 7
 Catgut 353
CATLIN Amputationsmesser 38
 Cerclage-Drähte 660
 Cerclage-Instrumente 660
CHAMPY Knochenbiopsie-Instrumente 669
CHAPUT Darm- und Gewebefaßzange 383
CHARRIERE Amputations- und Resektionssägen 572-573
CHEATTLE Sterilisierzangen 734
CHERON Korn- und Tupferzange 207
CHEVALIER-JACKSON Trachealkanülen 726
CHEVALIER Rippensperrer 507
CHEYNE-WATSON Dissektor 574
CHILDE Wundnahtpinzette 378
 Chirurgische Nähnadeln 354-356

Chirurgische Pinzetten 144-148
 Chirurgische Pinzetten fein 138-143
 Chirurgische Pinzetten TITE GRIP 117-118
 Chirurgische Scheren 71-83
 Chirurgische Scheren DURACUT 46
 Chirurgische Scheren fein 68-70
 Choanenhaken 221
 Cilienpinzetten 152
 Circumcisions-Instrumente 426
CITELLI Laminektomie-Stanze 707
CLAR Stirnlampe 11
CLEVELAND Knochensplitterzangen 637
CLOWARD Wirbelkörperspreizer 296
CLOWARD Wundspreizer für die Wirbelsäule 285
COAKLEY Kieferhöhlentroker 319
 Coarctationsklemmen ATRAUMATIC-GRIP 532-533, 557
COBB Raspatorien 589
COBB Raspatorien mit Ferrozellgriff 591
COBB Spinal-Hohlmeißel mit Ferrozellgriff 616
COLCLOUGH (LOVE-KERRISON) Laminektomie-Stanzen 710-711
COLLER-CRILE Feine Arterienklemmen 167
COLLIER Nadelhalter 363
COLLIN-BABY Bauchdeckenhalter 297
COLLIN-DUVAL Darm- und Gewebefaßzangen 386
COLLIN-DUVAL Darmpinzette 149
COLLIN-FARABEUF Raspatorien 588
COLLIN-HARTMANN Wundhaken 229
COLLIN-LANDAU Scheidenspekula 431
COLLIN ATRAUMATIC-GRIP Darm- und Gewebefaßzangen 389
COLLIN Bauchdeckenhalter 297-298
COLLIN Darm- und Gewebefaßzange 386
COLLIN Dynamometer 6
COLLIN Hammer 617
COLLIN Klammerentfernungszange 379
COLLIN Korn- und Tupferzange 207
COLLIN Nabelschnurklemme 486
COLLIN Scheidenspekula 431
COLLIN Uterusfaßzange 458
COLLIN Wundhaken 227
COLLIN Zungenzange 23
CONE Schädelstanzzange 688
CONTOUR SCALP Wundspreizer 276
CONVERSE (GILLIES) Hauthäkchen 216
CONVERSE TITE GRIP Nadelhalter 342
COOLEY-BECK ATRAUMATIC-GRIP Anastomosenklemmen 560
COOLEY-DERRA ATRAUMATIC-GRIP Anastomosenklemmen 559
COOLEY-REYNOLDS ATRAUMATIC-GRIP Anastomosenklemmen 559
COOLEY Aorta-Dilatator 511
COOLEY ATRAUMATIC-GRIP Anastomosenklemmen 560
COOLEY ATRAUMATIC-GRIP Aorta-Aneurysmaklemme 561
COOLEY ATRAUMATIC-GRIP Aortaklemme 561
COOLEY ATRAUMATIC-GRIP Bulldogklemmen 556
COOLEY ATRAUMATIC-GRIP Coarctationsklemmen 557
COOLEY ATRAUMATIC-GRIP Gefäßklemmen 555-556, 562
COOLEY ATRAUMATIC-GRIP Iliaca-Klemmen 558
COOLEY ATRAUMATIC-GRIP Mehrzweckklemmen 556, 562
COOLEY ATRAUMATIC-GRIP Nierenarterienklemmen 558
COOLEY ATRAUMATIC-GRIP Patent-Ductusklemmen 556
COOLEY ATRAUMATIC-GRIP Peripheralklemmen 558
COOLEY Atriumhaken 509
COOLEY Gefäßdilatoren 510
COOLEY Saugrohre 327
COOLEY Sternotomie-Sperrer 499
COOLEY Sternotomie-Sperrer aus ALUMINIUM 498
COOPER Unterbindungsnadel 374
 Coronararterien-Schere 95
CORWIN-HEGAR TITE GRIP Drahtspannzange 662
CORYLLOS Wundhaken und Lungenspatel 261
COTTLE-NEIVERT Nasenflügelhaken 221
COTTLE Dura- und Hauthäkchen 217
COTTLE DURACUT Nasenscheren 58
COTTLE Häkchen für plastische Chirurgie 218
COTTLE Hammer 620
COTTLE Nasenscheren 102
COTTLE Osteotome 608
COTTLE Raspatorien 583, 585
COTTLE Raspel 593
CRAFOORD-DE BAKEY ATRAUMATIC-GRIP
 Aorta-Aneurysmaklemmen 546

| | |
|---|----------|
| CRAFOORD-STILLE Feine Arterienklemmen | 170 |
| CRAFOORD (STELZNER) Lungenlappen- und Rektumschere | 99 |
| CRAFOORD Aurikelklemmen | 564 |
| CRAFOORD Feine Arterienklemme | 171 |
| CRAIG-KOGLER Wirbelkörper-Biopsieinstrumentarium | 720-721 |
| CRILE-BABY Feine Arterienklemmen | 166 |
| CRILE-COLLER Feine Arterienklemmen | 167 |
| CRILE-MICRO Feine Arterienklemmen | 166 |
| CRILE-MURRAY Nadelhalter | 366 |
| CRILE-RANKIN-DE BAKEY ATRAUMATIC-GRIP Feine Arterienklemmen | 167 |
| CRILE-RANKIN (OCHSNER-DIXON) Feine Arterienklemmen | 167 |
| CRILE-RANKIN Feine Arterienklemmen | 167 |
| CRILE-WOOD Nadelhalter | 366, 368 |
| CRILE-WOOD TITE GRIP Nadelhalter | 343 |
| CRILE-WOOD TITE GRIP Nadelhalter für Linkshänder | 341 |
| CRILE Feine Arterienklemmen | 166 |
| CRILE Nadelhalter | 371 |
| CRILE Nerv- und Gefäßhäkchen | 214 |
| CRILE TITAN-LINE Feine Arterienklemmen | 166 |
| CRILE Wundhaken | 227 |
| CRUTCHFIELD Schädelhalter | 689 |
| CRUTCHFIELD Vorbohrer für Schädelhalter | 689 |
| CULLEN-WERTHEIM Nierenstielklemme | 191 |
| CURTIS Chirurgische Pinzette | 147 |
| CUSCO Scheidenspekula | 430-431 |
| CUSHING-FERRIS-SMITH Laminektomie-Zangen | 713 |
| CUSHING-LANDOLT Spekula für trans-sphenoidale Hypophysektomie | 692 |
| CUSHING-TAYLOR Feine anatomische Pinzetten | 130 |
| CUSHING-TAYLOR Feine chirurgische Pinzetten | 143 |
| CUSHING-TAYLOR Ohr- und Nasenpinzetten | 136 |
| CUSHING-TAYLOR TITE GRIP Anatomische Pinzette | 114 |
| CUSHING Bohrer | 652 |
| CUSHING Dekompressionshaken | 701 |
| CUSHING Durahäkchen | 218 |
| CUSHING Feine anatomische Pinzetten | 130 |
| CUSHING Feine chirurgische Pinzetten | 142 |
| CUSHING Hirnspatel | 706 |
| CUSHING Laminektomie-Zangen | 715 |
| CUSHING Nerv- und Gefäßhäkchen | 214 |
| CUSHING TITE GRIP Anatomische Pinzetten | 114 |
| CUSHING Venenhaken | 222-223 |
| CUZZI Plazentar- und Abortuslöffel | 484 |
| CZERNY Hakenzange | 455 |
| CZERNY Mastdarm-Rektum-Spekulum | 405 |

D

| | |
|---|------------------|
| DAHLGREN Schädelstanze | 688 |
| DALE ATRAUMATIC-GRIP Peripheralklemmen | 535 |
| Damm- (Episiotomie-) Scheren | 107 |
| Damm- (Episiotomie-) Scheren DURACUT | 60 |
| DANDY Feine Arterienklemmen | 165 |
| DANDY Nerv- und Gefäßhäkchen | 214 |
| DARDIK ATRAUMATIC-GRIP Mehrzweckklemmen | 554 |
| Darm- und Magen-Nähapparat | 404 |
| Darmfaßzangen | 383-388 |
| Darmfaßzangen ATRAUMATIC-GRIP | 389 |
| Darmfaßzangen TITE GRIP | 388 |
| Darmklemmen | 390-396, 403 |
| Darmklemmen ATRAUMATIC-GRIP | 391-393, 395-396 |
| Darmnadeln | 354 |
| Darmpinzette | 149 |
| Darmscheren | 109 |
| Darmspatel | 266-267 |
| DARTIGUES Nierenfaßzange | 421 |
| DAUBENSPECK Scharfer Löffel | 604 |
| DAVIDSON Scapula-Haken | 260 |
| DAVIS-RAGNELL Haken für plastische Chirurgie | 226 |
| DAVIS Hirnspatel | 706 |
| DAY Ohrhäkchen | 213 |
| DE BAKEY-BAHNSON ATRAUMATIC-GRIP Aorta-Aneurysmaklemmen | 545 |
| DE BAKEY-BAINBRIDGE ATRAUMATIC-GRIP Gefäßklemmen | 530 |
| DE BAKEY-BECK ATRAUMATIC-GRIP Anastomosenklemmen | 543 |
| DE BAKEY-BECK ATRAUMATIC-GRIP Aortaklemmen | 537 |
| DE BAKEY-BECK ATRAUMATIC-GRIP Vena-Cava-Klemmen | 550 |
| DE BAKEY-CAROTIS ATRAUMATIC-GRIP Bulldogklemmen | 525 |
| DE BAKEY-CRAFOORD ATRAUMATIC-GRIP Aorta-Aneurysmaklemmen | 546 |

| | |
|--|----------|
| DE BAKEY-CRILE-RANKIN ATRAUMATIC-GRIP Feine Arterienklemmen | 167 |
| DE BAKEY-DERRA ATRAUMATIC-GRIP Anastomosenklemmen | 542 |
| DE BAKEY-DIETRICH ATRAUMATIC-GRIP Bulldogklemmen | 526 |
| DE BAKEY-GLOVER ATRAUMATIC-GRIP Bulldogklemmen | 525 |
| DE BAKEY-GUYON ATRAUMATIC-GRIP Nierenklemmen | 190 |
| DE BAKEY-HALSTED-MOSQUITO ATRAUMATIC-GRIP Feine Arterienklemmen | 165 |
| DE BAKEY-HARKEN ATRAUMATIC-GRIP Präparier- und Ligaturklemmen | 551 |
| DE BAKEY-HEANEY (ROGERS) ATRAUMATIC-GRIP Hysterektomieklappen | 197 |
| DE BAKEY-MORRIS ATRAUMATIC-GRIP Aortaklemmen | 540 |
| DE BAKEY-PEAN ATRAUMATIC-GRIP Arterienklemmen | 176 |
| DE BAKEY-PEAN ATRAUMATIC-GRIP Gefäßklemmen | 529 |
| DE BAKEY-POTTS ATRAUMATIC-GRIP Patent-Ductusklemmen | 531 |
| DE BAKEY-REYNOLDS ATRAUMATIC-GRIP Anastomosenklemmen | 542 |
| DE BAKEY-RUMEL ATRAUMATIC-GRIP Präparier- und Ligaturklemmen | 186 |
| DE BAKEY-RUMEL Präparier- und Ligaturklemmen | 186 |
| DE BAKEY-SATINSKY ATRAUMATIC-GRIP Bulldogklemmen | 525 |
| DE BAKEY-SATINSKY ATRAUMATIC-GRIP Gefäßklemmen | 541 |
| DE BAKEY-WERTHEIM (ROGERS) ATRAUMATIC-GRIP Parametriumklemmen | 197 |
| DE BAKEY (GARRETT) Gefäßdilatoren | 510 |
| DE BAKEY Arteriotomieschere | 95 |
| DE BAKEY ATRAUMATIC-GRIP Anastomosenklemmen | 543 |
| DE BAKEY ATRAUMATIC-GRIP Aorta-Aneurysmaklemmen | 545-547 |
| DE BAKEY ATRAUMATIC-GRIP Aortaklemmen | 539 |
| DE BAKEY ATRAUMATIC-GRIP Bulldogklemmen | 526, 528 |
| DE BAKEY ATRAUMATIC-GRIP Coarctationsklemmen | 532-533 |
| DE BAKEY ATRAUMATIC-GRIP Gefäßklemmen | 529, 541 |
| DE BAKEY ATRAUMATIC-GRIP Gefäßpinzetten | 135 |
| DE BAKEY ATRAUMATIC-GRIP Mehrzweckklemmen | 530, 553 |
| DE BAKEY ATRAUMATIC-GRIP Nierenerarterienklemme | 537 |
| DE BAKEY ATRAUMATIC-GRIP Patent-Ductusklemmen | 531 |
| DE BAKEY ATRAUMATIC-GRIP Peripheralklemmen | 534-536 |
| DE BAKEY ATRAUMATIC-GRIP Präparier- und Ligaturklemmen | 551 |
| DE BAKEY DURACUT Gefäßscheren | 57 |
| DE BAKEY Gefäßscheren | 96 |
| DE BAKEY Rippensperrerr | 504-505 |
| DE BAKEY Saugrohr | 325 |
| DE BAKEY TITE GRIP Gewebefaß- und Nadelzieh-Pinzetten | 116 |
| DE BAKEY TITE GRIP Nadelhalter | 343 |
| DE MARTEL-WOLFSON Dickdarm-Anastomosens-Klemmen | 402 |
| DE MARTEL-WOLFSON Klemmenhalter | 402 |
| DE MARTEL-WOLFSON Klemmenschießzange | 402 |
| DE MARTEL (BAILEY) Einführungsinstrument für Drahtsägen | 687 |
| DE VILBISS Schädelstanze | 688 |
| DE VILBISS Scheidenspekula | 433 |
| DEAN DURACUT Zahnfleischscheren | 55 |
| DEAN Tonsillenschere | 103 |
| DEAVER-FORD Wundhaken und Lungenspatel | 263 |
| DEAVER Chirurgische Scheren | 71 |
| DEAVER Wundhaken und Lungenspatel | 264-265 |
| Deckglaspinzette | 152 |
| DEJERINE Perkussionshämmer | 2 |
| Dekapitationshaken | 485 |
| Dekompressionshaken | 701 |
| DEMEL Drahtumführungsnadeln | 661 |
| DENHARDT Mundsperrerr | 22 |
| DENIS-BROWNE Bauchdeckenhalter | 305 |
| DENKER-UECKERMANN Not-Tracheotomietrokare | 728 |
| DERF Nadelhalter | 363 |
| DERF TITE GRIP Nadelhalter | 342 |
| Dermatome | 41-42 |
| DERRA-COOLEY ATRAUMATIC-GRIP Anastomosenklemmen | 559 |
| DERRA-DE BAKEY ATRAUMATIC-GRIP Anastomosenklemmen | 542 |
| DESCHAMPS Unterbindungsnadeln | 374-376 |
| DESJARDINS Gallengangsonden | 415 |
| DESJARDINS Gallensteinzangen | 419 |
| DESMARRES Venenhaken (Lidhalter) | 222 |
| DEUCHER Bauchdeckenhalter | 299 |
| DEVIN ATRAUMATIC-GRIP Karotis-Klemmen | 524 |
| DIEFFENBACH Bulldogklemmen | 163 |
| DIETRICH-DE BAKEY ATRAUMATIC-GRIP Bulldogklemmen | 526 |
| DIETRICH-HEGEMANN DURACUT Gefäßscheren | 56 |
| DIETRICH-HEGEMANN Gefäßscheren | 96 |
| DIETRICH ATRAUMATIC-GRIP Aortaklemmen | 539 |

| | |
|---|-----------------------|
| DIETRICH Gefäßscheren | 97 |
| DIETRICH Mikro-Bulldogklemmen | 162 |
| DIETRICH TITE GRIP Mikro-Nadelhalter | 339 |
| Dilatationsbougies | 424 |
| Dilatationsoliven, Gallengang- | 416 |
| Dilatatoren, Aorta- | 511 |
| Dilatatoren, Gefäß- | 510 |
| Dilatatoren, Intima- | 512 |
| Dilatatoren, Tracheal- | 728 |
| Dilatatoren, Uterus- | 443-445 |
| DINGMANN Knochenhaltezange | 624 |
| DINGMANN Modif. Knochenhaltezange | 624 |
| Dissektoren | 574, 693-694, 696-697 |
| Dissektoren, Dura- | 699-700 |
| Distrationsklammer | 630 |
| DITTEL Katheterspanner | 425 |
| DIXON-LOVELACE Feine Arterienklemmen | 169 |
| DIXON-OCHSNER (CRILE-RANKIN) Feine Arterienklemmen | 167 |
| DIXON (PEAN) Arterienklemmen | 174 |
| DOCKHORN Wundhaken | 245 |
| Doppelsonde | 694 |
| Dosen | 747 |
| DOUGLAS-BOZEMANN Tamponzangen | 208 |
| DOUGLAS Cilienpinzette | 152 |
| DOUGLAS Kieferhöhlentrokär | 320 |
| DOYEN-BABY ATRAUMATIC-GRIP Darmklemmen | 391 |
| DOYEN-BABY Darmklemmen | 391 |
| DOYEN-STILLE Wundhaken | 247 |
| DOYEN ATRAUMATIC-GRIP Darmklemmen | 392-393 |
| DOYEN Bauchdeckenhaken | 248-249 |
| DOYEN Bauchdeckenscheren | 106 |
| DOYEN Darmklemmen | 392-393 |
| DOYEN Hammer | 618 |
| DOYEN Hohlsonden | 314 |
| DOYEN Myomheber | 458 |
| DOYEN Polypen- und Ovarienzange | 457 |
| DOYEN Rippenraspatorien | 495 |
| DOYEN Scheidenhalter | 439 |
| DOYEN Tuchklemme | 200 |
| Draht, Silber- | 690 |
| Drahtbiegezangen | 666 |
| Drähte für Cerclage | 660 |
| Drahtfaßzangen | 663-664 |
| Drahtfaßzangen TITE GRIP | 663 |
| Drahtkneifzangen | 666 |
| Drahtkneifzangen DURACUT | 667 |
| Drahtsägen | 687 |
| Drahtscheren | 665 |
| Drahtscheren DURACUT | 665 |
| Drahtspanner | 660 |
| Drahtspannzangen TITE GRIP | 662 |
| Drahtumführungsnadeln | 660-661 |
| Dreieckschalen | 750 |
| Druckklemme | 409 |
| DUBOIS Kephalotomiescheren | 109 |
| DUPLAY Hakenzange | 453 |
| Dura-Dissektoren | 699-700 |
| Dura-Separatoren | 698 |
| DURACUT Adnexscheren | 54 |
| DURACUT Chirurgische Scheren | 46 |
| DURACUT Damm- (Episiotomie-) Scheren | 60 |
| DURACUT Drahtkneifzangen | 667 |
| DURACUT Drahtscheren | 665 |
| DURACUT Feine Scheren | 45 |
| DURACUT Fistelscheren | 45 |
| DURACUT Gefäßscheren | 45, 56-57 |
| DURACUT Gefäßscheren | 56-57 |
| DURACUT Gipsschere | 676 |
| DURACUT Gynäkologische Scheren | 60 |
| DURACUT Irisschere | 45 |
| DURACUT Ligaturscheren | 353 |
| DURACUT Nasenscheren | 58 |
| DURACUT Parametriumscheren | 60 |
| DURACUT Präparierscheren | 47-54 |
| DURACUT Schere für Rektumchirurgie | 59 |
| DURACUT Scheren für plastische Chirurgie | 45 |
| DURACUT Septumscheren | 59 |
| DURACUT Uterusscheren | 60 |
| DURACUT Verbandscheren | 673 |

| | |
|--|--------------|
| DURACUT Zahnfleischscheren | 55 |
| Durahäkchen | 212, 216-218 |
| Duramesser | 37 |
| DURANTE Gefäß- und Tumorpinzetten | 149 |
| Duraschere | 100 |
| DUVAL-COLLIN Darm- und Gewebefaßzangen | 386 |
| DUVAL-COLLIN Darmpinzette | 149 |
| DUVAL Darm- und Gewebefaßzangen | 386-387 |
| DUVAL Darmpinzette | 149 |
| DUVAL TITE GRIP Darm- und Gewebefaßzangen | 388 |
| Dynamometer | 6 |

E

| | |
|---|--------------|
| EASTMAN-RICHARDSON Wundhaken | 250 |
| EATON-BECKMANN Laminektomie-Wundspreizer | 280 |
| ECHLIN Hohlmeißelzangen | 634 |
| EDER Watteträger | 409 |
| EICKEN-KILLIAN Kieferhöhlenspülkanülen | 322 |
| Einführungsinstrument für Drahtsägen | 687 |
| EISELSBERG Ligatur- und Fadenschere | 352 |
| Elevatoren | 574-575 |
| EMMET Fistelhaken | 221 |
| EMMET Häkchen für Laserchirurgie | 449 |
| EMMET Korn- und Tupferzange | 207 |
| Endarterektomie-Satz | 515 |
| Endarterektomiestripper | 514 |
| Endocervix-Biopsieküretten | 459-460 |
| Endometrium-Saug-Biopsieküretten | 459 |
| Endometrium-Strichkürette | 459 |
| Endospekula | 443 |
| Endospekula für Laserchirurgie | 448 |
| ENGEL Gipssäge | 679 |
| ENGL. MOD. Tuchklemme | 200 |
| Entfernungszangen für Bulldogklemmen | 527 |
| Entfernungszangen für TITAN-LINE Bulldogklemmen | 160 |
| Entfernungszangen für Wundklammern | 379 |
| Enukleatoren | 693 |
| ERRICO Bohrer | 652 |
| Ersatzteile für oszillierende Gipssäge | 681 |
| ESMARCH Gipsmesser | 679 |
| ESMARCH Kleiderstoff- und Gipscheren | 675 |
| ESMARCH Staubbinde | 570 |
| ESMARCH Stauschlauch | 570 |
| EUFRATE PASQUE TITE GRIP Nadelhalter | 344 |
| EWALD Feine anatomische Pinzetten | 129 |
| EWALD Feine chirurgische Pinzetten | 140 |
| Explorationshäkchen | 215 |
| Extensionsbügel | 654, 658-659 |
| EYE FRENCH TITE GRIP Nadelhalter | 340 |

F

| | |
|---|----------|
| Fadenfänger | 378 |
| Fadenführer | 697 |
| Fadenführungszange | 423 |
| Fadengabeln | 378, 694 |
| Fadenpinzette | 152 |
| Fadenscheren | 352 |
| FAHLBUSCH-HARDY Dissektoren | 693 |
| FANSLER-IVES Anoskop | 407 |
| FARABEUF-ALEXANDER Rippenraspatorien | 497 |
| FARABEUF-COLLIN Raspatorien | 588 |
| FARABEUF-LAMBOTTE Knochenhaltezange | 626 |
| FARABEUF Raspatorien | 588 |
| FARABEUF Wundhaken | 227 |
| FARRELL (LATHBURY) Watteträger | 316 |
| Faßpinzetten | 149 |
| Faßpinzetten PERFECT-GRIP, Mikro- | 124 |
| Faßpinzetten, Mikro- | 124 |
| Faßzangen | 423 |
| Faßzangen TITE GRIP, Draht- | 663 |
| Faßzangen, Draht- | 663-664 |
| Faßzangen, Hämorrhoiden- | 410 |
| Faßzangen, IUP (Intrauterinpressar)- | 447 |
| Faßzangen, Kapsel- | 423 |
| Faßzangen, Knochen | 493 |

| | |
|--|---------------|
| Faßzangen, Knorpel- | 640 |
| Faßzangen, Meniskus- | 640 |
| Faßzangen, Nieren- | 421 |
| Faßzangen, Rippen | 493 |
| Faßzangen, Sehnen- | 647 |
| Faßzangen, Uterus- | 458 |
| FAURE Peritoneumklemmen | 193 |
| FAVALORO Coronararterien-Schere | 95 |
| Federhaken zur Galea-Fixation | 691 |
| FEHLAND ATRAUMATIC-GRIP Rektum-Anastomosenklemmen | 401 |
| FEILCHENFELD Splitterpinzetten | 150 |
| Feilen, Knochen- | 592, 594-595 |
| Feilen, Nagel- | 18 |
| FEIN Watteträger | 317 |
| Feine anatomische Pinzetten | 128-131 |
| Feine Arterienklemmen | 164-172 |
| Feine Arterienklemmen ATRAUMATIC-GRIP | 165, 167 |
| Feine Arterienklemmen TITAN-LINE | 164, 166, 168 |
| Feine chirurgische Pinzetten | 138-143 |
| Feine chirurgische Scheren | 68-70 |
| Feine Präparierscheren | 92-93 |
| Feine Scheren DURACUT | 45 |
| Feine Sehnscheren | 92 |
| FERGUSON Nähnadeln | 356 |
| FERGUSON Operationsschere | 80 |
| FERGUSON (FRAZIER) Saugkanülen | 323 |
| FERGUSON Knochenhaltezeuge | 624 |
| FERRIS-SMITH-CUSHING Laminektomie-Zangen | 713 |
| FERRIS-SMITH-KERRISON Laminektomie-Stanzen | 709-710, 712 |
| FERRIS-SMITH Chirurgische Pinzetten | 147 |
| Finger-Wundspreizer | 270 |
| Fingernagel-Instrumente | 645 |
| Fingerringssägen | 645 |
| FINOCHIETTO-BABY-HAIGHT Rippensperrer aus ALUMINIUM | 501 |
| FINOCHIETTO-BABY Rippensperrer | 503 |
| FINOCHIETTO-BURFORD Rippensperrer | 503 |
| FINOCHIETTO-BURFORD Rippensperrer aus ALUMINIUM | 502 |
| FINOCHIETTO-INFANT Rippensperrer aus ALUMINIUM | 501 |
| FINOCHIETTO-RIENHOFF Rippensperrer | 506 |
| FINOCHIETTO Modif. Rippensperrer aus ALUMINIUM | 500 |
| FINOCHIETTO Nadelhalter | 369 |
| FINOCHIETTO Rippensperrer | 503 |
| FINOCHIETTO Rippensperrer aus ALUMINIUM | 501 |
| FINOCHIETTO Thorax- und Ligaturklemme | 564 |
| FINOCHIETTO TITE GRIP Nadelhalter | 346 |
| FINSEN Wundspreizer | 270 |
| FISCH Durahäkchen | 212 |
| FISCHER Sehnschäler | 646 |
| Fistelhaken | 221 |
| Fistelscheren | 80 |
| Fistelscheren DURACUT | 45 |
| Fistelsonden | 314, 409 |
| Flachmeißel | 607, 609-610 |
| Flachmeißel mit Ferrozellgriff | 611, 613-614 |
| FLETCHER (JAVERTS) Tupfer- und Schwammzange | 210 |
| FLUHRER Knopfsonden | 313 |
| FOERSTER-BALLENGER Tupfer- und Schwammzangen | 209 |
| FOERSTER (FORBES) Tupfer- und Schwammzange | 210 |
| FOERSTER Bauchdeckenhalter | 308 |
| FOMON Choanenhaken | 221 |
| FOMON DURACUT Nasenscheren | 58 |
| FOMON Knochenfeilen | 595 |
| FOMON Nasenflügelscheren | 81 |
| FOMON Nasenflüglhaken | 221 |
| FOMON Nasenscheren | 102 |
| FOMON Raspeln | 595 |
| FOMON Scheren für plastische Chirurgie | 82 |
| FOMON TITE GRIP Raspeln | 597 |
| FORBES (FOERSTER) Tupfer- und Schwammzange | 210 |
| FORD-DEAVER Wundhaken und Lungenspatel | 263 |
| FOSS Wundhaken und Lungenspatel | 263 |
| FOX-GOLDMANN DURACUT Zahnfleischscheren | 55 |
| FOX-GOLDMANN Zahnfleischscheren | 94 |
| FOX Lupusküretten | 20 |
| FRANZ Bauchdeckenhalter | 304 |
| FRAZIER (FERGUSON) Saugkanülen | 323 |
| FRAZIER Dura- und Hauthäkchen | 216 |
| FRAZIER Dura-Separator | 698 |
| FRAZIER Saugkanülen | 323 |

| | |
|---|---------|
| FREER Flachmeißel | 607 |
| FREER Raspatorien | 583 |
| FREER Wundhäkchen | 218 |
| FRENCH EYE TITE GRIP Nadelhalter | 340 |
| FRENZEL Zungenspatel | 12 |
| FREY-SAUERBRUCH Rippenschere | 493 |
| FRIEDMAN-LUER Hohlmeißelzange | 631 |
| FRITSCH Wundhaken | 250 |
| FROHN Watteträger | 316 |
| FRYKHOLM Hohlmeißelzangen | 635 |
| Führungshohlsonden | 377-378 |
| Führungsnadeln | 334 |
| Führungszange, Katheter- und Schlauch- | 473 |

G

| | |
|--|--|
| GALLAHER Raspel | 592 |
| Gallenblasenlöffel | 417 |
| Gallenblasentrokare | 318 |
| Gallengang-Dilatationsoliven | 416 |
| Gallengangsonden | 415 |
| Gallensteinlöffel | 417 |
| Gallensteinsonde | 415 |
| Gallensteinzangen | 418-419 |
| GANSKE-BIRCHER Meniskus- und Knorpelfaßzangen | 640 |
| GARRETT (DE BAKEY) Gefäßdilatoren | 510 |
| GAYLOR-THOMS Uterus-Biopsiezange | 460 |
| Geburtshilfe-Instrumente | 481, 486 |
| Geburtslöffel | 481 |
| Geburtszangen | 478-480 |
| Gefäßclips | 154-156 |
| Gefäßdilatoren | 510 |
| Gefäßhäkchen | 213-215 |
| Gefäßklemmen ATRAUMATIC-GRIP | 520-523, 529-530, 534, 537, 541, 555-556, 558, 561-562 |
| Gefäßklemmen halbflexibel | 563 |
| Gefäßmesser | 694-695 |
| Gefäßnadeln | 354 |
| Gefäßpinzetten | 148-149 |
| Gefäßpinzetten ATRAUMATIC-GRIP | 135 |
| Gefäßscheren | 80, 95-98 |
| Gefäßscheren DURACUT | 45, 56-57 |
| Gefäßspülkanülen | 322 |
| GEISSENDOERFER-OVERHOLT Präparier- und Ligaturklemmen | 184 |
| GELPI-BABY Vulva-Spreizer | 281 |
| GELPI-SELETZ Vulva-Spreizer | 281 |
| GELPI Vulva-Spreizer | 281 |
| GEMINI-MIXTER Präparier- und Ligaturklemmen | 181 |
| GEMINI Präparier- und Ligaturklemmen | 181 |
| GERALD Feine anatomische Pinzetten | 130 |
| GERALD Feine chirurgische Pinzetten | 142 |
| GERALD TITE GRIP Anatomische Pinzette | 114 |
| GERALD TITE GRIP Chirurgische Pinzette | 117 |
| Geräte zur Beschriftung | 757 |
| Geräte zur Markierung | 757 |
| GERSTER Distractionsklammer | 630 |
| GERZOG Hammer | 618 |
| Gewebefaß-Pinzetten TITE GRIP | 116 |
| Gewebefaßpinzetten | 126-127, 148 |
| Gewebefaßzangen | 383-388 |
| Gewebefaßzangen ATRAUMATIC-GRIP | 389 |
| Gewebefaßzangen TITE GRIP | 388 |
| GIBBON-BAILEY Rippenkontraktor | 508 |
| GIERTZ-STILLE Rippenschere | 492 |
| GIGLI (OLIVERCRONA) Drahtsägen | 687 |
| GIGLI Handgriffe für Drahtsägen | 687 |
| GIL-VERNET (MARBERGER) Venen- und Hilushaken | 223 |
| GILLIES-BABY Nadelhalter | 370 |
| GILLIES-BABY TITE GRIP Nadelhalter | 348 |
| GILLIES (CONVERSE) Hauthäkchen | 216 |
| GILLIES Feine chirurgische Pinzetten | 142 |
| GILLIES Hauthäkchen | 216 |
| GILLIES Nadelhalter | 370 |
| GILLIES TITE GRIP Chirurgische Pinzette | 117 |
| GILLIES TITE GRIP Nadelhalter | 348 |
| Gipsabreißzangen | 682 |
| Gipsmesser | 679 |
| Gipssäge | 679 |

Gipssäge oscillierend 680
 Gipssäge oscillierend - Ersatzteile 681
 Gipsscheren 675-678
 Gipsscheren DURACUT 676
 Gipsspreizer 682
 Glaspipette zur Mikro-Blutentnahme 473
GLASSMANN (KILNER) Präparierscheren 83
GLOVER-DE BAKEY ATRAUMATIC-GRIP Bulldogklemmen 525
GLOVER ATRAUMATIC-GRIP Anastomosenklemmen 544
GLUCK Rippenschiere 492
GOELET Wundhaken 229
GOLDMANN-FOX DURACUT Zahnfleischscheren 55
GOLDMANN-FOX Zahnfleischscheren 94
GOOD Tonsillenschiere 103
GOODELL Uterus-Dilatator 443
GORNEY DURACUT Septumschiere 59
GORNEY Scheren für plastische Chirurgie 82
GOSSET-BABY Bauchdeckenhalter 299
GOSSET Bauchdeckenhalter 299-300
GOURDET Uteruslöffel 466
GRAEFE (TYRELL) Hauthäkchen (Irishäkchen) 216
GRAEFE Chirurgische Pinzette 148
GRAEFE Feine anatomische Pinzetten 128
GRAEFE Feine chirurgische Pinzetten 139
GRAEFE Schielhaken 213
GRAHAM Durahäkchen 217
GRAMCKO-BUCK Knochenhebel 576
GRAVE Modif. Scheidenspekula 432
GRAVE Scheidenspekula 432-433
GREEN-ARMYTAGE Uterusklemmzange 481
GREEN-SENN Wundhaken 224
GREEN Schilddrüsenhaken 243
GREEN Tuchklemme 200
GREGORY-SOFT ATRAUMATIC-GRIP Karotisklemmen 527
GREGORY ATRAUMATIC-GRIP Profundaklemmen 534
GRONINGEN Nerv- und Gefäßhäkchen 215
GROSS Korn- und Tupferzangen 204
GRUENWALD-LOVE Laminektomie-Zangen 716
GRUENWALD (JANSEN) Ohr- und Nasenpinzette 136
GRUENWALD Ohr- und Nasenpinzetten 136
 Gummiringe, Ligatur 410
GUNNAR-HEY Schlauchroller 203
GUTHRIE Hauthäkchen (Irishäkchen) 218
GUYON-DE BAKEY ATRAUMATIC-GRIP Nierenklemmen 190
GUYON Katheter-Einführungsinstrument 425
GUYON Katheterspanner 425
GUYON Nierenklemme 190
 Gynäkologische Scheren DURACUT 60

H

HABERER Bauch- und Darmspatel 267
 Hähne für Spritzen 333
HAIGHT-FINOCHIETTO-BABY Rippensperrerr aus ALUMINIUM 501
HAIGHT Rippensperrerr 506
HAJEK-KOFLER Laminektomie-Stanzen 708
HAJEK Hämmer 617
 Häkchen 696
 Häkchen für Laserchirurgie 449
 Häkchen für Mikrochirurgie 212
 Häkchen für plastische Chirurgie 217-219
 Häkchen, Dura- 212, 216-218
 Häkchen, Explorations- 215
 Häkchen, Gefäß- 213-215
 Häkchen, Haut- 216-218
 Häkchen, Iris- 216-218
 Häkchen, Koagulations- 215
 Häkchen, Nerv- 213-215
 Häkchen, Ohr- 213
 Häkchen, Tracheal- 217, 219-220, 728
 Häkchen, Wund- 212, 216-221
 Haken für plastische Chirurgie 226
 Haken zur Galea-Fixation, Feder- 691
 Haken, Atrium- 509
 Haken, Bauchdecken- 248-249, 309
 Haken, Choanen- 221
 Haken, Dekapitations- 485
 Haken, Dekompressions- 701

Haken, Fistel- 221
 Haken, Hilus- 223
 Haken, Knochen- 232
 Haken, Krypt- 409
 Haken, Leber- 255
 Haken, Lungen- 260
 Haken, Meniskus- 641
 Haken, Nasenflügel- 221
 Haken, Nervwurzel- 701
 Haken, Pelvis- 258
 Haken, Prostata- 422
 Haken, Scapula- 260
 Haken, Schiel- 213
 Haken, Schilddrüsen- 243
 Haken, Sehnenscheiden- 225
 Haken, Tracheal- 226
 Haken, Venen- 217, 222-223
 Haken, Wund- 222-259, 261-265, 641
 Haken-Bulbus 422
 Hakenzangen 452-456
 Halbflexible Gefäßklemmen 563
HALLE Duramesser 37
HALLE Intima-Spatel 512
HALLE Raspatorien 582
HALLE Scharfe Löffel 604
HALSEY Nadelhalter 363
HALSEY TITE GRIP Nadelhalter 342
HALSEY TITE GRIP Nadelhalter für Linkshänder 341
HALSTED-MICRO Feine Arterienklemmen 164
HALSTED-MOSQUITO-DE BAKEY ATRAUMATIC-GRIP feine Arterienklemmen 165
HALSTED-MOSQUITO (HEISS) Feine Arterienklemmen 170
HALSTED-MOSQUITO Feine Arterienklemmen 164-165
HALSTED-MOSQUITO TITAN-LINE Feine Arterienklemmen 164
HALSTED Feine Arterienklemmen 169, 171
 Halter für Mikro Klingen 473
 Halter, Klemmen- 402
 Halter, Lid- 222
 Halter, Schädel- 689
 Halter, Scheiden- 434-437, 439
 Hämmer 2-3, 617-618, 620-621
 Hämmer mit Ferrozellgriff 619
 Hämorrhoiden-Faßzange 410
 Hämorrhoiden-Ligatoren 410
 Hämorrhoiden-Saugligatoren 411
 Hand- und Carpal- Tunnel-Wundspreizer 271
 Hand- und Unterarm-Wundspreizer 271
 Handbohrapparate 651-653
 Handgriffe für Drahtsägen 687
 Handhalter 644
 Handtuchablagekörbe 753
 Handwaschbürste 752
HARDY-FAHLBUSCH Dissektoren 693
HARDY Dissektoren 693
HARDY Eukleatoren 693
HARDY Implantationsgabel 693
HARDY Küretten 692
HARKEN-DE BAKEY ATRAUMATIC-GRIP Präparier- und Ligaturklemmen 551
HARRINGTON-MAYO Präparierscheren 86
HARRINGTON Wundhaken und Lungenspatel 262
HARTMANN-COLLIN Wundhaken 229
HARTMANN (MOSQUITO-BABY) Feine Arterienklemmen 164
HARTMANN Ohrkatheter 322
HARTMANN Stimmgabeln 4
HARTMANN Uterus-Biopsiezangen 462
HASSELLTINE Nabelschnurklemmen 486
 Hauthäkchen 216-218
 Hautstanzbesteck 20
 Hautstanzen 20
HAVERFIELD-SCOVILLE Laminektomie-Spreizer 286
HAYES ATRAUMATIC-GRIP Rektum-Anastomosenklemmen 400
HEANEY-BALENTINE Hysterektomieklamme 196
HEANEY-DE BAKEY (ROGERS) ATRAUMATIC-GRIP Hysterektomieklammen 197
HEANEY-REZEK Hysterektomieklamme 196
HEANEY-SIMON Wundhaken 254
HEANEY Chirurgische Pinzetten 147
HEANEY Hysterektomieklammen 196

| | |
|---|--------------|
| HEANEY Nadelhalter | 369 |
| HEANEY TITE GRIP Nadelhalter | 346 |
| HEATH-RICHTER Klammerentfernungszange | 379 |
| HEATH Hammer | 620 |
| HEGAR-BABY-OLSEN TITE GRIP Nadelhalter | 348 |
| HEGAR-BAUMGARTNER TITE GRIP Nadelhalter | 342 |
| HEGAR-CORWIN TITE GRIP Drahtspannzange | 662 |
| HEGAR-MAYO Nadelhalter | 367 |
| HEGAR-MAYO TITE GRIP Nadelhalter | 345 |
| HEGAR-MAYO TITE GRIP Nadelhalter für Linkshänder | 341 |
| HEGAR-OLSEN Nadelhalter | 370 |
| HEGAR-OLSEN TITE GRIP Nadelhalter | 348 |
| HEGAR Uterus-Dilatatoren | 444-445 |
| HEGEMANN-DIETRICH DURACUT Gefäßscheren | 56 |
| HEGEMANN-DIETRICH Gefäßscheren | 96 |
| HEGENBARTH Klammeranlegepinzette | 379 |
| HEIFETZ Hirnspatel | 706 |
| HEIFETZ Tumor- und Gewebefäßpinzetten | 127 |
| HEISS (HALSTED-MOSQUITO) Feine Arterienklemmen | 170 |
| HEISS (PAUL-MIXTER) Präparier- und Ligaturklemme | 182 |
| HEISTER Mundsperrer | 22 |
| Hemilaminektomie-Wundspreizer | 277 |
| HEMINGWAY Scharfe Löffel | 599 |
| HENLEY Wundspreizer | 282-283 |
| HENNIG Gipsspreizer | 682 |
| HERRICK Nierenstielklemme | 191 |
| HEY-GUNNAR Schlauchroller | 203 |
| HEYMANN DURACUT Nasenscheren | 58 |
| HEYMANN Nasenscheren | 101 |
| HEYWOOD-SMITH Polypen- und Ovarienzange | 457 |
| HEYWOOD-SMITH Zungenzangen | 23 |
| HIBBS Wundhaken | 231 |
| Hilushaken | 223 |
| Hirnmesser | 40 |
| Hirnspatel | 706 |
| HIRSCHMANN Anuskope | 407 |
| HOEN Raspatorien | 586 |
| HOGLUND-LOWMAN Knochenhalteklammer | 630 |
| Hohlmeißel | 607, 609-610 |
| Hohlmeißel-Spinal mit Ferrozellgriff | 616 |
| Hohlmeißel-Spongiosa mit Ferrozellgriff | 615 |
| Hohlmeißel mit Ferrozellgriff | 611-616 |
| Hohlmeißelzangen | 494, 631-636 |
| Hohlsonden | 314 |
| HOHMANN-ALDINGER Knochenhebel | 580 |
| HOHMANN-LANGE Knochenhebel | 577 |
| HOHMANN-LANGE Modif. Knochenhebel | 577 |
| HOHMANN-MINI Knochenhebel | 576 |
| HOHMANN Knochenhebel | 578-580 |
| HOKE Osteotome | 607 |
| HOLSHER Nervwurzelhaken | 701 |
| HOLZBACH Hysterektomieklammern | 194 |
| HOPKINS-JOHNS Anlege- und Entfernungszange für Bulldogklemmen | 527 |
| HOPKINS-JOHNS Bulldogklemmen | 163 |
| HOPKINS Gipsmesser | 679 |
| HORGAN Mittelvalve für Bauchdeckenhalter | 303 |
| HORNE-JOBSON Watteträger | 317 |
| HORSLEY-LISTON-KEY Knochensplitterzange | 494 |
| HORSLEY Dura-Separator | 698 |
| HÖSEL Wundhaken | 246 |
| HOSPITAL-PROVIDENCE Feine Arterienklemmen | 168 |
| HOUSE Scharfe Löffel | 598 |
| HOWARD Raspatorium | 583 |
| HRYNTSCHAK-YOUNG Bumerang-Nadelhalter | 372 |
| HUDSON Handbohrapparat | 652 |
| Hüfthebel | 580 |
| HULKA-KENWICK Hakenzangen | 453 |
| HULKA Hakenzange | 453 |
| HUMBY Dermatome | 42 |
| HUNTER Splitterpinzetten | 150 |
| HURD Unterbindungsnadeln | 374 |
| Hypophysektomie-Instrumente | 692-693 |
| Hypophysenzange | 719 |
| Hysterektomieklammern | 194-196 |
| Hysterektomieklammern ATRAUMATIC-GRIP | 197 |

| | |
|--|---------|
| Iliaca Klemmen ATRAUMATIC-GRIP | 558 |
| Implantationsgabel | 693 |
| INFANT-FINOCHIETTO Rippensperrer aus ALUMINIUM | 501 |
| INGE Wirbelkörperspreizer | 296 |
| Injektionskanüle | 486 |
| Instrumentarium zur Amnioskopie | 472-473 |
| Instrumentarium zur Hysterosalpingographie | 474 |
| Instrumentarium zur Mikro-Blutentnahme | 472-473 |
| Instrumente, Tunnelier- | 517 |
| Instrumenten-Pflegemittel | 733 |
| Instrumentenablageplatten | 748 |
| Instrumentenkästen | 746 |
| Insulin-Spitzen | 330 |
| Intima-Dilatatoren | 512 |
| Intima-Messer | 513 |
| Intima-Spatel | 512-513 |
| Inzisionsschere | 80 |
| IOWA Blasensprenger | 477 |
| IOWA Injektionskanüle | 486 |
| IOWA Nadelführung | 486 |
| Irishäkchen | 216-218 |
| Irisscheren DURACUT | 45 |
| Irrigatoren | 751 |
| ISRAEL Wundhaken | 237 |
| IUP (Intrauterinpeppisar)- Faßzangen | 447 |
| IVES-FANSLER Anuskop | 407 |

J

| | |
|---|----------|
| JACKSON-CHEVALIER Trachealkanülen | 726 |
| JACKSON Scheidenspekula | 438 |
| JACKSON Sehnenfaßzange | 647 |
| JACKSON Trachealhäkchen | 217 |
| JACKSON Trachealhaken | 226 |
| JACOBS Hakenzange | 456 |
| JACOBSON Doppelsonde | 694 |
| JACOBSON Fadengabel | 694 |
| JACOBSON Gefäßmesser | 694 |
| JACOBSON Knopfsonde | 694 |
| JACOBSON Mikro-Scheren | 64 |
| JACOBSON PERFECT-GRIP Mikro-Nadelhalter | 359 |
| JACOBSON TITE GRIP Mikro-Nadelhalter | 338 |
| JAMESON Feine Präparierscheren | 93 |
| JAMESON Nadelhalter | 368 |
| JANET Wund- und Blasenspritzen | 331 |
| JANET Zylinder für Spritzen | 331 |
| JANSEN-ZAUFL Hohlmeißelzangen | 633 |
| JANSEN (GRUENWALD) Ohr- und Nasenpinzette | 136 |
| JANSEN Hohlmeißelzangen | 632 |
| JANSEN Ohr- und Nasenpinzette | 136 |
| JANSEN Raspatorium | 587 |
| JANSEN Scharfe Löffel | 599 |
| JANSEN Stirnlampe | 11 |
| JANSEN Wundspreizer | 272 |
| JAVERTS (FLETCHER) Tupfer- und Schwammzange | 210 |
| JAVID ATRAUMATIC-GRIP Karotis-Klemmen | 537 |
| JOBSON-HORNE Watteträger | 317 |
| JOHNS-HOPKINS Anlege- und Entfernungszange für Bulldogklemmen | 527 |
| JOHNS-HOPKINS Bulldogklemmen | 163 |
| JONES-LELAND ATRAUMATIC-GRIP Peripheralklemmen | 534 |
| JONES Tuchklemmen | 200 |
| JORGENSEN Präparierschere | 98 |
| JOSEPH Häkchen für plastische Chirurgie | 217, 219 |
| JOSEPH Knochenfeile | 592 |
| JOSEPH Nasenplastikmesser | 37 |
| JOSEPH Raspatorien | 582 |
| JOSEPH DURACUT Scheren für plastische Chirurgie | 45 |
| JOSEPH Scheren für plastische Chirurgie | 70 |
| JUDD-ALLIS Darm- und Gewebefäßzangen | 384 |
| JUDD-MASSON Blasenwundspreizer | 310 |

K

| | |
|--|-----|
| KADER Bauch- und Darmspatel | 267 |
| KALLMORGEN Scheidenspekula und -halter | 434 |

| | | | |
|---|---------------|---|--|
| KALT Gefäßnadeln | 354 | Klammeranlegezangen | 379, 690-691 |
| KALT Nadelhalter | 363 | Klammerblock | 690-691 |
| Kaltlicht-Proximalbeleuchtung für Amnioskop Tuben | 472 | Klammerentfernungszangen | 379 |
| Kanülen für die Leberblindpunktion | 329 | Klammerinstrumentarium | 690-691 |
| Kanülen zur Brustfellpunktion | 329, 518 | Klammern, Knochenhalte- | 630 |
| Kanülen zur gezielten Leberpunktion | 329 | Klammern, Kopfhaut- | 691 |
| Kanülen zur Lumbalpunktion | 328 | Klammern, Silber- | 690 |
| Kanülen zur Sternalpunktion | 329, 518 | Klammern, Sterilisier- | 736 |
| Kanülen, Biopsie- | 518, 529 | KLAPP Sehnenscheidenhaken | 225 |
| Kanülen, Gefäß- | 322 | Kleiderstoffscheren | 674-675 |
| Kanülen, Injektions- | 486 | Klein-Transformator für Stirnlampen | 11 |
| Kanülen, Kieferhöhlenpunktions- | 319 | KLEINERT-KUTZ Sehnendurchziehange | 649 |
| Kanülen, Kieferhöhlenspül- | 322 | KLEINSCHMIDT Spornquetsche und Appendektomieklamme | 403 |
| Kanülen, Peritoneal-Pneu- | 329 | Klemmen ATRAUMATIC-GRIP, Obere Verschluß- | 398 |
| Kanülen, Saug- | 320-323 | Klemmen ATRAUMATIC-GRIP, Untere Verschluß- | 399 |
| Kanülen, Septum- | 328 | Klemmen ATRAUMATIC-GRIP, Anastomosen- | 400-401, 520-523, 542-544, 559-560 |
| Kanülen, Spezial- | 328 | Klemmen ATRAUMATIC-GRIP, Aorta- | 537-540, 561 |
| Kanülen, Tonsillen- | 328 | Klemmen ATRAUMATIC-GRIP, Aorta-Anastomosen- | 548-549 |
| Kanülen, Tracheal- | 725-727 | Klemmen ATRAUMATIC-GRIP, Aorta-Aneurysma- | 545-547, 561 |
| Kanülen, Ventil-Sprech- | 726-727 | Klemmen ATRAUMATIC-GRIP, Arterien- | 176 |
| Kappenzangen | 735 | Klemmen ATRAUMATIC-GRIP, Bronchus- | 552 |
| Kapselmaßzange | 423 | Klemmen ATRAUMATIC-GRIP, Bulldog- | 525-528, 556 |
| Karotis-Klemmen ATRAUMATIC-GRIP | 524, 527, 537 | Klemmen ATRAUMATIC-GRIP, Coarctations- | 532-533, 557 |
| Katheter- und Schlauch-Führungszange | 473 | Klemmen ATRAUMATIC-GRIP, Darm- | 391-393, 395-396 |
| Katheter, Metall- | 424 | Klemmen ATRAUMATIC-GRIP, Gefäß- | 520-523, 529-530, 534, 537, 541, 555-556, 558, 561-562 |
| Katheter, Ohr- | 322 | Klemmen ATRAUMATIC-GRIP, Hysterektomie- | 197 |
| Katheter-Einführungsinstrument | 425 | Klemmen ATRAUMATIC-GRIP, Iliaca- | 558 |
| Katheter-Einführungszangen | 32 | Klemmen ATRAUMATIC-GRIP, Karotis- | 524, 527, 537 |
| Katheterspanner | 425 | Klemmen ATRAUMATIC-GRIP, Ligatur- | 186, 551 |
| KATSCH Komедonenquetscher | 19 | Klemmen ATRAUMATIC-GRIP, Magen- | 397 |
| KAY-LAMBERT ATRAUMATIC-GRIP Aorta-Anastomosenklemmen | 549 | Klemmen ATRAUMATIC-GRIP, Mehrzweck- | 520-523, 530, 553-554, 556, 562 |
| KAZANJIAN Knochensplitterzange | 637 | Klemmen ATRAUMATIC-GRIP, Nieren- | 190 |
| Kehlkopfspiegel | 13-14 | Klemmen ATRAUMATIC-GRIP, Nierenarterien- | 537, 558 |
| KELLY-BABY Feine Arterienklemmen | 168 | Klemmen ATRAUMATIC-GRIP, Parametrium- | 197 |
| KELLY-RANKIN Feine Arterienklemmen | 169 | Klemmen ATRAUMATIC-GRIP, Patent-Ductus- | 531, 556 |
| KELLY DURACUT Gefäß- und Fistelscheren | 45 | Klemmen ATRAUMATIC-GRIP, Peripheral- | 534-536, 558 |
| KELLY Feine Arterienklemmen | 168 | Klemmen ATRAUMATIC-GRIP, Präparier- | 186, 551 |
| KELLY Gefäß- und Fistelscheren | 80 | Klemmen ATRAUMATIC-GRIP, Profunda- | 534 |
| KELLY Polypen- und Ovarienzange | 457 | Klemmen ATRAUMATIC-GRIP, Rektum- | 400-401 |
| KELLY Sphinkterskope | 407 | Klemmen ATRAUMATIC-GRIP, Vena-Cava- | 550 |
| KELLY TITAN-LINE Feine Arterienklemmen | 168 | Klemmen aus TITAN, Bulldog- | 160-161 |
| KELLY Wundhaken | 251, 255 | Klemmen fein ATRAUMATIC-GRIP, Arterien- | 165, 167 |
| Kennzeichnungsschilder | 743 | Klemmen fein TITAN-LINE, Arterien- | 164, 166, 168 |
| KENWICK-HULKA Hakenzangen | 453 | Klemmen fein, Arterien- | 164-172 |
| Kephalotomiescheren | 109 | Klemmen halbflexibel, Gefäß- | 563 |
| KERN-LANE Knochenhaltezange | 625 | Klemmen Mikro, Bulldog- | 162 |
| KERN-MINI Knochenhaltezange | 625 | Klemmen zum Fixieren des Samenstrangs | 425 |
| KERRISON-FERRIS-SMITH Laminektomie-Stanzen | 709-710, 712 | Klemmen, Anastomosen- | 400-402 |
| KERRISON-LOVE (COLCLOUGH) Laminektomie-Stanzen | 710-711 | Klemmen, Anastomosen- (Vena Cava) | 565 |
| KERRISON Laminektomie-Stanzen | 707 | Klemmen, Appendektomie- | 403 |
| KEVOURKIAN-PACIFIC Uterus-Biopsiezange | 464 | Klemmen, Arterien- | 173-179 |
| KEVOURKIAN-YOUNGE Endocervix-Biosieküretten | 459 | Klemmen, Aurikel- | 564 |
| KEVOURKIAN-YOUNGE Uterus-Biopsiezange | 463, 465 | Klemmen, Bronchus- | 566 |
| KEY-HORSLEY-LISTON Knochensplitterzange | 494 | Klemmen, Bulldog- | 163 |
| KEY Raspatorien | 589 | Klemmen, Darm- | 390-396, 403 |
| KEYES Hautstanzbesteck | 20 | Klemmen, Druck- | 409 |
| KEYES Hautstanzen | 20 | Klemmen, Hysterektomie- | 194-196 |
| Kieferhöhlenpunktionskanülen | 319 | Klemmen, Ligatur- | 180-189, 564 |
| Kieferhöhlenspülkanülen | 322 | Klemmen, Magenquetsch- | 403 |
| Kieferhöhlentrokare | 319-320 | Klemmen, Muskel- | 728 |
| KIELAND-LUIKART Geburtszange | 479 | Klemmen, Nabelschnur- | 486 |
| KIELAND Geburtszange | 479 | Klemmen, Nieren- | 190 |
| KILLIAN-EICKEN Kieferhöhlenspülkanülen | 322 | Klemmen, Nierenstiel- | 191 |
| KILLIAN (MÜHLING) Septumschere | 102 | Klemmen, Penis- | 426 |
| KILLIAN Raspatorien | 583 | Klemmen, Peritoneum- | 192-193 |
| KILNER (GLASSMANN) Präparierscheren | 83 | Klemmen, Präparier- | 180-189, 564 |
| KILNER Feine Präparierscheren | 93 | Klemmen, Rektum- | 400-402 |
| KILNER Hauthäkchen | 216 | Klemmen, Schlauch- | 203 |
| KILNER TITE GRIP Nadelhalter | 342 | Klemmen, Sehneneinflecht- | 649 |
| KIRK Hammer | 618 | Klemmen, Sinus- | 204 |
| KIRKLIN Venenhaken | 223 | Klemmen, Thorax- | 564 |
| KIRSCHNER-BALFOUR Valven für Bauchdeckenhalter | 307 | Klemmen, Tonsillen- | 179 |
| KIRSCHNER Bauchdeckenhalter | 306 | Klemmen, Tuch- | 200-202 |
| KIRSCHNER Bohrdrähte | 655 | Klemmenhalter | 402 |
| KIRSCHNER Extensionsbügel | 658-659 | Klemmenschließzange | 402 |
| KIRSCHNER Führungshohlsonde | 377 | KLIMA-ROSEGGGER Kanülen zur Sternalpunktion | 329, 518 |
| KIRSCHNER Valven für Bauchdeckenhalter | 307 | | |
| Klammer, Distractions- | 630 | | |
| Klammeranlegepinzetten | 379 | | |

| | |
|---|---------------|
| Klingen | 36 |
| Klingen-Mikro zur Blutentnahme | 473 |
| KLINGENBERGH-LOTH Präparierschere | 98 |
| KNAPP Feine chirurgische Scheren | 68 |
| KNAPP Wundhäkchen | 218 |
| KNIGHT DURACUT Nasenscheren | 58 |
| KNIGHT Nasenscheren | 101 |
| Knochenbiopsie-Instrumente | 669 |
| Knochenfaßzangen | 493 |
| Knochenfeilen | 592, 594-595 |
| Knochenhaken | 232 |
| Knochenhalteklammern | 630 |
| Knochenhaltezangen | 624-629 |
| Knochenhebel | 576-581 |
| Knochensplitterzangen | 494, 637-639 |
| Knopfsonden | 312-313, 694 |
| Knorpelfaßzangen | 640 |
| Knorpelschere | 82 |
| KNOWLES Verbandschere | 673 |
| Knüpppinzetten PERFECT-GRIP, Mikro- | 121-123 |
| Knüpppinzetten TITE GRIP | 113 |
| Knüpppinzetten, Mikro- | 121-123 |
| KNUTSON Urethrographie-Instrument | 426 |
| Koagulationshäkchen | 215 |
| KOCHER-BABY ATRAUMATIC-GRIP Darmklammern | 391 |
| KOCHER-BABY Darmklammern | 391 |
| KOCHER-LANGENBECK Wundhaken | 240 |
| KOCHER-OCHSNER Arterienklammern | 177 |
| KOCHER Arterienklammern | 176 |
| KOCHER ATRAUMATIC-GRIP Darmklammern | 395 |
| KOCHER Blasenspatel | 268 |
| KOCHER Darmklammern | 392-394 |
| KOCHER Kropfsonden | 378 |
| KOCHER Wund- und Knochenhaken | 232 |
| KOCHER Wundhaken | 235, 242, 244 |
| KOENIG Führungshohlsonden | 377 |
| KOERTE-LUER Gallensteinlöffel | 417 |
| KOERTE Wundhaken | 236 |
| KOFLER-HAJEK Laminektomie-Stanzen | 708 |
| KOGAN Endospekula | 443 |
| KOGAN Endospekula für Laserchirurgie | 448 |
| KÖLN MOD. Kopfhautklammern | 691 |
| Komedonenquetscher | 19 |
| Komprimierer zur Erzeugung einer Blutleere | 570 |
| KÖNIG-ROSER Mundsperrer | 22 |
| KÖNIG Raspatorien | 582 |
| Konisationsstift | 447 |
| KONRICH Sterilisiertrommeln | 743 |
| Kontraktoren, Rippen- | 508 |
| KOOS Gefäßmesser | 695 |
| Kopfhautklammern | 691 |
| Kopfhebel | 481 |
| Kopflupen, binokular | 8-9 |
| Kopfschneider | 668 |
| Kopfschwartenzange | 481 |
| Körbe für Sterilisation | 745 |
| Körbe, Bürstenablage- | 753 |
| Körbe, Handtuchablage- | 753 |
| Kornzangen | 204-207 |
| Kraftmesser | 6 |
| Kranioklast | 485 |
| Krankenpflegeartikel | 751 |
| KRAUS Gefäßmesser | 695 |
| KRAUSE Kieferhöhlentrokcar | 319 |
| KRAYENBÜHL Nerv- und Gefäßhäkchen | 215 |
| KRISTELLER Scheidenspekula und -halter | 434-437 |
| KROENLEIN Arterienklemme | 173 |
| KRONECKER Unterbindungsnadeln | 374 |
| Kropfsonden | 378 |
| Kropfwundhaken | 224 |
| Krypthaken | 409 |
| KÜHNE Deckglaspinzette | 152 |
| Küretten | 692 |
| Küretten, Abortus- | 484 |
| Küretten, Absaug- | 471 |
| Küretten, Biopsie- | 459-460 |
| Küretten, Endocervix-Biopsie- | 459-460 |
| Küretten, Endometrium-Saug-Biopsie- | 459 |
| Küretten, Endometrium-Strich- | 459 |

| | |
|--|---------|
| Küretten, Lupus- | 20 |
| Küretten, Plazentar- | 484 |
| Küretten, Uterus- | 466-470 |
| KUTZ-KLEINERT Sehnedurchziehzange | 649 |

L

| | |
|--|------------------------|
| LA GRANGE Zahnfleissschere | 94 |
| LABORDE Trachealdilatator | 728 |
| LAHEY-SWEET Präparier- und Ligaturklemme | 189 |
| LAHEY Hakenzange | 454 |
| LAHEY Kropfwundhaken | 224 |
| LAHEY Präparier- und Ligaturklammern | 189 |
| LAHEY Wundhäkchen | 219 |
| LAMBERT-KAY ATRAUMATIC-GRIP Aorta-Anastomosenklemmen | 549 |
| LAMBERT-LOWMAN Knochenhalteklammer | 630 |
| LAMBOTTE-FARABEUF Knochenhaltezange | 626 |
| LAMBOTTE-MINI Osteotome | 608 |
| LAMBOTTE Knochenhaltezangen | 626-627 |
| LAMBOTTE Osteotome | 608 |
| LAMBOTTE Rippenraspatorien | 497 |
| Laminektomie-Stanzen | 707-712 |
| Laminektomie-Wundspreizer | 276, 279-280, 284, 286 |
| Laminektomie-Zangen | 713-719 |
| LANDAU-COLLIN Scheidenspekula | 431 |
| LANDAU Scheidenspekula | 440 |
| LANDOLT-CUSHING Spekula für trans-sphenoidale Hypophysektomie | 692 |
| LANDOLT Raspatorium | 585 |
| LANE-KERN Knochenhaltezange | 625 |
| LANE-MURPHY Luxationshebel | 581 |
| LANE Knochenhaltezange | 625 |
| LANE Tuchklemme | 201 |
| LANGE-HOHMANN Knochenhebel | 577 |
| LANGE-HOHMANN Modif. Knochenhebel | 577 |
| LANGE Verbandscheren | 672 |
| LANGENBECK-KOCHER Wundhaken | 240 |
| LANGENBECK-MINI Wundhaken | 224 |
| LANGENBECK-PARKER (US-ARMY) Wundhaken | 231 |
| LANGENBECK-RYDER TITE GRIP Nadelhalter | 350 |
| LANGENBECK Amputations- und Resektionssäge | 572 |
| LANGENBECK Elevatorien | 575 |
| LANGENBECK Knochenhaltezange | 624 |
| LANGENBECK Raspatorien | 587 |
| LANGENBECK Resektionsmesser | 38 |
| LANGENBECK TITE GRIP Nadelhalter | 350 |
| LANGENBECK Wundhaken | 238-239 |
| Lappenmesser | 39 |
| Laryngoskope | 24-31 |
| Laserchirurgie-Instrumente | 448-451 |
| Lateral-Spekulum für Laserchirurgie | 448 |
| LATHBURY (FARRELL) Watteträger | 316 |
| LAWRENCE Präparier- und Ligaturklemme | 187 |
| LAWTON-MATHIEU TITE GRIP Nadelhalter | 349 |
| LAWTON TITE GRIP Nadelhalter | 349 |
| LAZAR Mikro-Knüpppinzetten | 121 |
| Leberhaken | 255 |
| LEBSCHKE Sternummeißel | 492 |
| LEES ATRAUMATIC-GRIP Bronchusklemmen | 552 |
| LEGUEU Blasenspatel | 268 |
| LEKSELL-STILLE Hohlmeißelzangen | 635 |
| LELAND-JONES ATRAUMATIC-GRIP Peripheralklemmen | 534 |
| LEMMON Intima-Spatel | 512 |
| LEMPERT Hohlmeißelzangen | 631-632 |
| LEMPERT Raspatorien | 584 |
| LEMPERT Scharfe Löffel | 604 |
| LERICHE Feine Arterienklammern | 165 |
| LEWIN Repositionszange | 622 |
| LEWIS Raspeln | 592 |
| LEXER-BABY Präparierscheren | 87 |
| LEXER-MAYO DURACUT Präparierscheren | 48 |
| LEXER-MAYO Präparierscheren | 87 |
| LEXER-MINI Hohlmeißel mit Ferrozellgriff | 612 |
| LEXER-MINI Osteotome mit Ferrozellgriff | 612 |
| LEXER DURACUT Präparierscheren | 49 |
| LEXER Hohlmeißel mit Ferrozellgriff | 612-613 |
| LEXER Osteotome mit Ferrozellgriff | 612-613 |
| LEXER Präparierscheren | 87 |
| LEXER Spongiosa-Hohlmeißel mit Ferrozellgriff | 615 |

| | |
|--|------------------|
| LEYLA Retraktoren zur Fixation am OP-Tisch | 704-705 |
| LEYLA Retraktoren zur Fixation am Schädel | 702-703 |
| LICHTENBERG TITE GRIP Nadelhalter | 349 |
| LICHTWITZ Kieferhöhlenpunktionskanülen | 319 |
| LICHTWITZ Kieferhöhlentrokare | 320 |
| LICHTWITZ V. EICKEN Kieferhöhlenpunktionskanülen | 319 |
| Lidhalter | 222 |
| Ligatoren, Hämorrhoiden- | 410-411 |
| Ligatur-Gummiringe | 410 |
| Ligaturklemmen | 180-189, 564 |
| Ligaturklemmen ATRAUMATIC-GRIP | 186, 551 |
| Ligaturscheren | 352-353 |
| Ligaturscheren DURACUT | 353 |
| LINDORF TITE GRIP Drahtspannzange | 662 |
| Linse für Lupenbrillen | 9 |
| LISTER DURACUT Verbandscheren | 673 |
| LISTER modif. Verbandschere | 673 |
| LISTER Sinusklemmen | 204 |
| LISTER Universal Verband- und Kleiderstoffschere | 674 |
| LISTER Verbandscheren | 673 |
| LISTON-KEY-HORSLEY Knochensplitterzange | 494 |
| LISTON-LITTAUER Knochensplitterzange | 637 |
| LISTON-RUSKIN Knochensplitterzangen | 638 |
| LISTON-WALTON (BÖHLER) Knochensplitterzangen | 638 |
| LISTON Amputationsmesser | 38 |
| LISTON Knochensplitterzangen | 637, 639 |
| LITTAUER-LISTON Knochensplitterzange | 637 |
| LITTAUER Cilienpinzette | 152 |
| LITTAUER Ligatur- und Fadenschere | 352 |
| LITTLER Präparierschere | 81 |
| LOCKHART-MUMMERY Fistelsonden | 314 |
| LOCKLIN DURACUT Zahnfleischscheren | 55 |
| LOCKLIN Zahnfleischscheren | 94 |
| LOCKWOOD Darm- und Gewebefaßzange | 386 |
| Löffel mit Ferrozellgriff, scharfe | 606 |
| Löffel, Abortus | 484 |
| Löffel, Gallenblasen- | 417 |
| Löffel, Gallenstein- | 417 |
| Löffel, Geburts- | 481 |
| Löffel, Plazentar- | 484 |
| Löffel, scharfe | 598-606, 695-696 |
| Löffel, Sekret- | 425 |
| Löffel, Uterus- | 466 |
| LONG Hysterektomieklammer | 194 |
| LORNA Tuchklemmen | 202 |
| LOTH-KLINGENBERGH Präparierschere | 98 |
| LOTH-SCHOEMAKER Ligatur- und Fadenschere | 352 |
| LOUTE Drahtspanner | 660 |
| LOVE-GRUENWALD Laminektomie-Zangen | 716 |
| LOVE-KERRISON (COLCLOUGH) Laminektomie-Stanzen | 710-711 |
| LOVE Nervwurzelhaken | 701 |
| LOVELACE-DIXON Feine Arterienklemmen | 169 |
| LOVELACE Darm- und Gewebefaßzange | 387 |
| LOWER Präparier- und Ligaturklemme | 189 |
| LOWMAN-HOGLUND Knochenhalteklammer | 630 |
| LOWMAN-LAMBERT Knochenhalteklammer | 630 |
| LOWMAN Knochenhalteklammern | 630 |
| LUCAE Hammer | 617 |
| LUCAE Ohr- und Nasenpinzette | 136 |
| LUCAE Ohrhäkchen | 213 |
| LUCAE Stimmgabel | 4 |
| LUCAS scharfe Löffel | 599 |
| LUER-FRIEDMAN Hohlmeißelzange | 631 |
| LUER-KOERTE Gallensteinlöffel | 417 |
| LUER-STILLE Hohlmeißelzangen | 634, 636 |
| LUER Hohlmeißelzangen | 631-632 |
| LUER Trachealkanülen | 725 |
| LUER Wundhaken | 227 |
| LUIKART-KIELAND Geburtszange | 479 |
| Lungenfaßpinzetten | 149 |
| Lungenhaken | 260 |
| Lungenlappenschere | 99 |
| Lungenspatel | 260-265 |
| Lupe allein für Lupenbrillen | 9 |
| Lupenbrille, binokular | 9 |
| Lupusküretten | 20 |
| Lupusschaber | 19 |
| Luxationshebel | 581 |

M

| | |
|---|----------|
| Magen- und Darm-Nähapparat | 404 |
| Magenklemmen ATRAUMATIC-GRIP | 397 |
| Magenquetschklemmen | 403 |
| MAGILL Katheter-Einführungszangen | 32 |
| MAIER-SIMS Korn- und Tupferzangen | 205 |
| MAIER Korn- und Tupferzangen | 205 |
| MALTZ Raspel | 593 |
| MALTZ TITE GRIP Raspeln | 596 |
| MARBACH Damm- (Episiotomie-) Scheren | 107 |
| MARBERGER (GIL-VERNET) Venen- und Hilushaken | 223 |
| Markierungsgeräte | 757 |
| MARKWALDER Rundmeißelzange | 494 |
| MARQUARDT Hohlmeißelzange | 634 |
| MARTIN Beckenzirkel | 477 |
| MARTIN Meniskus- und Knorpelfaßzangen | 640 |
| MARTIN Wundhaken | 254 |
| MARTINI Scharfe Löffel | 598 |
| Maßband | 6 |
| MASSON-JUDD Blasenwundspreizer | 310 |
| MASSON Nadelhalter | 368 |
| MASSON TITE GRIP Nadelhalter | 347 |
| Maßstäbe | 6 |
| Mastdarm-Biopsiezangen | 412 |
| Mastdarm-Spekula | 405-406 |
| MASTIN Muskelklemme | 728 |
| MATHIEU-LAWTON TITE GRIP Nadelhalter | 349 |
| MATHIEU Mastdarm-Rektum-Spekulum | 405 |
| MATHIEU Nadelhalter | 371 |
| MATHIEU Scheidenhalter | 439 |
| MATHIEU Scheidenspekula | 439 |
| MATHIEU TITE GRIP Nadelhalter | 349 |
| MATHIEU Wundhaken | 226, 230 |
| MATSON Rippenraspatorien | 497 |
| MATZENAUER Scheidenspekula | 440 |
| MAUNDER Mundkeil | 22 |
| MAYFIELD Hohlmeißelzange | 633 |
| MAYO-ADAMS Appendektomie-Wundspreizer | 284 |
| MAYO-BLAKE Gallensteinzangen | 418 |
| MAYO-HARRINGTON Präparierscheren | 86 |
| MAYO-HEGAR Nadelhalter | 367 |
| MAYO-HEGAR TITE GRIP Nadelhalter | 345 |
| MAYO-HEGAR TITE GRIP Nadelhalter für Linkshänder | 341 |
| MAYO-LEXER DURACUT Präparierscheren | 48 |
| MAYO-LEXER Präparierscheren | 87 |
| MAYO-NOBLE Präparierscheren | 86 |
| MAYO-ROBSON ATRAUMATIC-GRIP Darmklemmen | 396 |
| MAYO-ROBSON Darmklemmen | 396 |
| MAYO-STILLE DURACUT Präparierscheren | 48 |
| MAYO-STILLE Präparierscheren | 85 |
| MAYO Bauchdeckenhaken | 249 |
| MAYO DURACUT Präparierscheren | 47 |
| MAYO Gallensteinlöffel | 417 |
| MAYO Gefäß- und Tumorpinzette | 149 |
| MAYO Präparierscheren | 84 |
| MAYO Sterilisierklammern | 736 |
| MAYO Zungenspatel | 12 |
| MC DONALD Dissektor | 574 |
| MC GIVNEY Hämorrhoiden-Faßzange | 410 |
| MC INDOE Feine anatomische Pinzette | 130 |
| MC INDOE Knochensplitterzange | 638 |
| MC INDOE Knorpelschere | 82 |
| MC INDOE TITE GRIP Anatomische Pinzette | 113 |
| MC INTOSH Laryngoskope | 24-27 |
| MC INTOSH Laryngoskopie-Bestecke | 24-25 |
| MC KENTY Raspatorien | 582 |
| MC KENZIE Bohrer | 652 |
| MC KENZIE Klammer-Anlegezangen für Silberklammern | 690 |
| MC KENZIE Klammerblock | 690 |
| MC KENZIE Silberdraht | 690 |
| MC KENZIE Silberklammern | 690 |
| MC PHERSON Mikro-Knüpfpinzetten | 122 |
| MEAD Hammer | 618 |
| MEAD Hohlmeißelzangen | 631 |
| Meatotom | 426 |
| Medizinbecher | 751 |
| Medizinlöffel | 751 |

| | | | |
|---|---------------------------------|--|--------------|
| MEEKER-BABY Präparier- und Ligaturklemmen | 180 | MILLER Laryngoskopie-Bestecke | 28, 30 |
| MEEKER Präparier- und Ligaturklemme | 187 | MILLER Raspeln | 592 |
| Mehrfach-Bohrdrahtspender | 657 | MILLER TITE GRIP Raspeln | 596 |
| Mehrweckklemmen ATRAUMATIC-GRIP | 520-523, 530, 553-554, 556, 562 | MILLES Mikro-Scheren | 64 |
| Meißel mit Ferrozellgriff, Flach- | 611, 613-614 | MILLIGAN Dura-Separator | 698 |
| Meißel mit Ferrozellgriff, Hohl- | 611-616 | MILLIN-YOUNG Bumerang-Nadelhalter | 372 |
| Meißel, Flach- | 607, 609-610 | MILLIN Blasenhalsspreizer | 423 |
| Meißel, Hohl- | 607, 609-610 | MILLIN Blasenwundspreizer | 310 |
| Meißel, Sternum- | 492 | MILLIN Fadenführungszange | 423 |
| MENGHINI Kanülen für die Leberblindpunktion | 329 | MILLIN Faßzange | 423 |
| MENGHINI Kanülen zur gezielten Leberpunktion | 329 | MILLIN Kapselfaßzange | 423 |
| Meniskusfaßzangen | 640 | MINI-HOHMANN Knochenheber | 576 |
| Meniskushaken | 641 | MINI-KERN Knochenhaltezeange | 625 |
| Meniskusmesser | 642-643 | MINI-LAMBOTTE Osteotome | 608 |
| MERCEDES Thoraxsperrer | 507 | MINI-LANGENBECK Wundhaken | 224 |
| Messbecher | 751 | MINI-LEXER Hohlmeißel mit Ferrozellgriff | 612 |
| Messer für Autopsie | 40 | MINI-LEXER Osteotome mit Ferrozellgriff | 612 |
| Messer, Amputations- | 38-39 | MINI-STILLE Gipsscheren | 677 |
| Messer, Beinhaut- | 39 | MINI-YASARGIL Anlegepinzetten | 154 |
| Messer, Gefäß- | 694-695 | MINI-YASARGIL Gefäßclips | 154 |
| Messer, Gips- | 679 | MIOTTI-OVERHOLT Präparier- und Ligaturklemmen | 185 |
| Messer, Hirn- | 40 | MIXTER-BABY Präparier- und Ligaturklemmen | 180 |
| Messer, Intima- | 513 | MIXTER-GEMINI Präparier- und Ligaturklemmen | 181 |
| Messer, Lappen- | 39 | MIXTER-O'SHAUGNESSY Präparier- und Ligaturklemme | 182 |
| Messer, Meniskus- | 642-643 | MIXTER-OVERHOLT Präparier- und Ligaturklemme | 183 |
| Messer, Nasenplastik- | 37 | MIXTER-PAUL (HEISS) Präparier- und Ligaturklemme | 182 |
| Messer, Organ- | 40 | MIXTER Chirurgische Scheren | 79 |
| Messer, Phalangen- | 39 | MIXTER Gallensteinzange | 419 |
| Messer, Resektions- | 38-39 | MIXTER Präparier- und Ligaturklemmen | 182, 188-189 |
| Messer, Sezier- | 40 | MOBERG Wundhaken | 224 |
| Messer, Zwischenknochen- | 39 | MOD. BONN Feine chirurgische Pinzetten | 138 |
| Meßinstrumente | 6-7 | MOD. CANAD. Meniskusmesser | 643 |
| Meßinstrumente für Laserchirurgie | 448 | MOD. KÖLN Kopfhautklammern | 691 |
| Meßsonde für Laserchirurgie | 450 | MOD. MÜNCHEN Endometrium-Strichkürette | 459 |
| Metallgriffe für Kehlkopfspiegel | 13 | MOD. SWITZERLAND Mikro-Pinzetten (Uhrmacher Modelle) | 120 |
| Metallkatheter | 424 | MOD. USA Anatomische Pinzetten | 133 |
| METZENBAUM-BABY Präparierscheren | 89 | MOD. USA Chirurgische Pinzetten | 145 |
| METZENBAUM-NELSON DURACUT Präparierscheren | 53 | MOD. USA Gipsspreizer | 682 |
| METZENBAUM-NELSON Präparierscheren | 91 | MOD. USA Nabelschnurschere | 108 |
| METZENBAUM-THOREK DURACUT Adnexscheren | 54 | MOD. USA Scharfe Löffel | 601 |
| METZENBAUM DURACUT Präparierscheren | 49-52, 54 | MOD. WIENER Fadenfänger | 378 |
| METZENBAUM Präparierscheren | 88-90 | MODELL RUSS. Gefäß- und Tumorzinzetten | 149 |
| MEYERDING Laminektomie-Wundspreizer | 284 | MOGEN Beschneidungs- (Circumcisions-) Instrument | 426 |
| MEYERDING Wundhaken | 225 | MOLDESSTADT Venenhaken | 217 |
| MICHEL Klammeranlege- und Entfernungszange | 379 | MÖLTGEN Winkelmesser | 7 |
| MICHEL Klammeranlegepinzette | 379 | MOORE-STAUDE Hakenzange | 452 |
| MICHEL Rhinoskopiepiegel | 14 | MOORE Gallenblasenlöffel | 417 |
| MICHEL Wundklammern | 379 | MORGAN-TISCHLER Uterus-Biopsiezange | 464 |
| MICRO-ADSON Feine anatomische Pinzetten | 129 | MORRIS-DE BAKEY ATRAUMATIC-GRIP Aortaklemmen | 540 |
| MICRO-ADSON Feine chirurgische Pinzetten | 140-141 | MORSE Sternotomie-Sperrer | 499 |
| MICRO-ADSON TITE GRIP Chirurgische Pinzetten | 117 | MOSQUITO-BABY (HARTMANN) Feine Arterienklemmen | 164 |
| MICRO-CASTROVIEJO Nadelhalter | 358 | MOSQUITO-HALSTED-DE BAKEY ATRAUMATIC-GRIP Feine Arterienklemmen | 165 |
| MICRO-CRILE Feine Arterienklemmen | 166 | MOSQUITO-HALSTED (HEISS) Feine Arterienklemmen | 170 |
| MICRO-HALSTED Feine Arterienklemmen | 164 | MOSQUITO-HALSTED Feine Arterienklemmen | 164-165 |
| MIDDELDORF Wundhaken | 243 | MOSQUITO-HALSTED TITAN-LINE Feine Arterienklemmen | 164 |
| Mikro-Absaugrohr | 321 | MOTT-PARKER Wundhaken | 228 |
| Mikro-Bulldogklemmen | 162 | MOYNIHAN Arterienklemmen | 178 |
| Mikro-Faßpinzetten | 124 | MOYNIHAN Gallensteinsonde | 415 |
| Mikro-Faßpinzetten PERFECT-GRIP | 124 | MÜHLING (KILLIAN) Septumschere | 102 |
| Mikro-Instrumente | 694-697 | MÜHLING Raspatorien | 584 |
| Mikro-Klingen zur Blutentnahme | 473 | MÜLLER-BIEMER Approximatoren | 157 |
| Mikro-Knüpfpinzetten | 121-123 | MÜLLER-VERBRUGGE Knochenheber | 579 |
| Mikro-Knüpfpinzetten PERFECT-GRIP | 121-123 | MÜLLER Approximatoren | 158 |
| Mikro-Nadelhalter | 358-362 | MUMMERY-LOCKHART Fistel Sondens | 314 |
| Mikro-Nadelhalter PERFECT-GRIP | 359, 361-362 | Mundkeil | 22 |
| Mikro-Nadelhalter TITE GRIP | 338-339 | Mundsperrer | 22 |
| Mikro-Pinzetten | 125 | MURLESS Kopfheber | 481 |
| Mikro-Pinzetten (Uhrmacher-Modelle) | 120 | MURPHY-LANE Luxationsheber | 581 |
| Mikro-Pinzetten TITE GRIP | 118 | MURPHY Stirnband | 10 |
| Mikro-Präparierscheren | 65, 67 | MURRAY-CRILE Nadelhalter | 366 |
| Mikro-Scheren | 62-67 | MUSEUX Hakenzangen | 456 |
| Mikroskopier-Pinzetten | 121 | Muskelklemme | 728 |
| MIKULICZ-BABY Peritoneumklemme | 192 | MYERS Venenstripper | 315 |
| MIKULICZ Leberhaken | 255 | Myomheber | 458 |
| MIKULICZ Peritoneumklemmen | 192-193 | Myrtenblattsonden | 313 |
| MIKULICZ Wundhaken | 255 | | |
| MILAN Endocervix-Biopsieküretten | 460 | | |
| MILLER-SENN Wundhaken | 226 | | |
| MILLER Laryngoskope | 28-31 | | |

N

| | |
|--|--------------|
| NABATOFF Venenstripper..... | 315 |
| Nabelschnurklemmen | 486 |
| Nabelschnurscheren | 108 |
| Nadel-Sterilisierdosen | 357 |
| Nadelführung | 486 |
| Nadelhalter | 363-372 |
| Nadelhalter, Bumerang-..... | 372 |
| Nadelhalter-Mikro | 358-362 |
| Nadelhalter-Mikro TITE GRIP | 338-339 |
| Nadelhalter PERFECT-GRIP..... | 364-365 |
| Nadelhalter PERFECT-GRIP, Mikro | 359, 361-362 |
| Nadelhalter TITE GRIP | 340-350 |
| Nadelhalter TITE GRIP für Linkshänder | 341 |
| Nadeln REVERDIN | 373 |
| Nadeln, Augen-..... | 354 |
| Nadeln, Darm-..... | 354 |
| Nadeln, Drahtumführungs-..... | 660-661 |
| Nadeln, Gefäß-..... | 354 |
| Nadeln, Näh-..... | 354-356 |
| Nadeln, Unterbindungs-..... | 374-376 |
| Nadelzieh-Pinzetten TITE GRIP | 116 |
| NAEGELE Geburtszangen | 478 |
| Nägel | 654 |
| Nagelausreißzange | 645 |
| Nagelbohrer | 645 |
| Nagelfeilen | 18 |
| Nagelhautscheren | 16 |
| Nagelhautzangen | 17 |
| Nagelscheren | 16 |
| Nagelspaltschere | 81 |
| Nagelspaltzange | 17, 645 |
| Nagelzangen | 17 |
| Nähapparat für Magen und Darm | 404 |
| Nähnadeln, chirurgisch | 354-356 |
| Nähseide | 353 |
| Nahtinstrumente | 378 |
| Nasenflügelhaken | 221 |
| Nasenflügelscheren | 81 |
| Nasenpinzetten | 136-137 |
| Nasenplastikmesser | 37 |
| Nasensaugrohre | 324 |
| Nasenscheren | 101-102 |
| Nasenscheren DURACUT | 58 |
| NEFF Meniskussmesser | 642 |
| NEGUS Arterien- und Tonsillenklemmen | 179 |
| NEIVERT-COTTLE Nasenflügelhaken | 221 |
| NEIVERT Nadelhalter | 363 |
| NEIVERT TITE GRIP Nadelhalter | 342 |
| NELATON Hohlsonden | 314 |
| NELSON-METZENBAUM DURACUT Präparierscheren | 53 |
| NELSON-METZENBAUM Präparierscheren | 91 |
| NELSON Chirurgische Pinzette | 148 |
| NELSON Trokare | 318 |
| Nerv-Approximator | 159 |
| Nerv-Präparierschere | 93 |
| Nervhäkchen | 213-215 |
| Nervwurzelhaken | 701 |
| Neurochirurgie-Scheren | 100 |
| NEW ORLEANS Nadelhalter | 367 |
| NEW ORLEANS TITE GRIP Nadelhalter | 344 |
| NEWS Trachealhäkchen | 217 |
| Nierenarterienklemme ATRAUMATIC-GRIP | 537, 558 |
| Nierenfaßzange | 421 |
| Nierenklemmen | 190 |
| Nierenklemmen ATRAUMATIC-GRIP | 190 |
| Nierenschalen | 750 |
| Nierensteinzangen | 420-421 |
| Nierenstiellklemmen | 191 |
| NOBLE-MAYO Präparierscheren | 86 |
| NORTHBENT (SPENCER) Ligatur- und Fadenscheren | 352 |
| Not-Tracheotomietrokare | 728 |
| NOTO Polypen- und Ovarienzange | 457 |
| NOTT Scheidenspekula | 433 |
| NOVAK Endometrium-Saug-Biopsiekürette | 459 |

O

| | |
|--|---------|
| Obere Verschlussklemme ATRAUMATIC-GRIP | 398 |
| O'BRIEN Ligatur- und Fadenschere | 352 |
| OBWEGESER TITE GRIP Knüpfpinzetten | 113 |
| OBWEGESER Wundhaken | 241 |
| OCHSNER-ALLIS Darm- und Gewebefaßzange | 383 |
| OCHSNER-DIXON (CRILE-RANKIN) Feine Arterienklemmen | 167 |
| OCHSNER-KOCHER Arterienklemmen | 177 |
| OCHSNER-ROCHESTER Arterienklemmen | 178 |
| OCHSNER ATRAUMATIC-GRIP Aortaklemmen | 539 |
| OCHSNER Fadenpinzette | 152 |
| OCHSNER Gallenblasentrokare | 318 |
| OCHSNER Gallengangsonde | 415 |
| O'CONNOR-O'SULLIVAN Bauchdeckenhalter | 304 |
| O'CONNOR Hauthäkchen (Irishäkchen) | 217 |
| OEHLER TITE GRIP Chirurgische Pinzetten | 118 |
| Ohrhäkchen | 213 |
| Ohrkatheter | 322 |
| Ohrpinzetten | 136-137 |
| Öhrsonden | 313 |
| Öhrspritzen | 332 |
| OLDEBERG Hypophysenzange | 719 |
| OLIVECRONA-TOENNIS (SCOVILLE) Klammer-Anlegezangen für Silberklammern | 690 |
| OLIVECRONA Dura-Dissektoren | 700 |
| OLIVECRONA Hirnspatel | 706 |
| OLIVECRONA Trigemini-Schere | 100 |
| OLIVERCRONA (GIGLI) Drahtsägen | 687 |
| OLLIER Wundhaken | 236 |
| OLSEN-BABY-HEGAR TITE GRIP Nadelhalter | 348 |
| OLSEN-HEGAR Nadelhalter | 370 |
| OLSEN-HEGAR TITE GRIP Nadelhalter | 348 |
| OMBREDANNE Hammer | 621 |
| Operationsschere | 80 |
| Optiken für BERGER Kopfflupe | 8 |
| Organmesser | 40 |
| Oscillierende Gipsäge | 680 |
| Oscillierende Gipsäge - Ersatzteile | 681 |
| O'SHAUGNESSY-MIXTER Präparier- und Ligaturklemme | 182 |
| Osteotome | 607-610 |
| Osteotome mit Ferrozellgriff | 611-613 |
| O'SULLIVAN-O'CONNOR Bauchdeckenhalter | 304 |
| Ovarienzangen | 457 |
| OVERHOLT-BABY Präparier- und Ligaturklemme | 183 |
| OVERHOLT-GEISSENDOERFER Präparier- und Ligaturklemmen | 184 |
| OVERHOLT-MIOTTI Präparier- und Ligaturklemmen | 185 |
| OVERHOLT-MIXTER Präparier- und Ligaturklemme | 183 |
| OVERHOLT Präparier- und Ligaturklemmen | 183-185 |

P

| | |
|---|----------|
| PACIFIC-KEVOURKIAN Uterus-Biopsiezange | 464 |
| Parametriummklemmen ATRAUMATIC-GRIP | 197 |
| Parametriumscheren DURACUT | 60 |
| PARK-ALAN Analspreizer | 408 |
| PARKER-LANGENBECK (US-ARMY) Wundhaken | 231 |
| PARKER-MOTT Wundhaken | 228 |
| PARKER Wundhaken | 228 |
| PASQUE EUFRATE TITE GRIP Nadelhalter | 344 |
| Patellazange | 623 |
| Patent-Ductusklemmen ATRAUMATIC-GRIP | 531, 556 |
| PAUFIQUE Feine chirurgische Pinzette | 139 |
| PAUL-MIXTER (HEISS) Präparier- und Ligaturklemme | 182 |
| PAUL Sehnenscheidenhaken | 225 |
| PAYR-BABY Darm- und Magenquetschklemme | 403 |
| PAYR Darm- und Magenquetschklemmen | 403 |
| PAYR Führungshohlsonden | 377 |
| PAYR Gefäßnadeln | 354 |
| PEAN-DE BAKEY ATRAUMATIC-GRIP Arterienklemmen | 176 |
| PEAN-DE BAKEY ATRAUMATIC-GRIP Gefäßklemmen | 529 |
| PEAN-ROCHESTER Arterienklemmen | 175 |
| PEAN (DIXON) Arterienklemmen | 174 |
| PEAN Arterienklemmen | 173-174 |
| PEDERSON Scheidenspekula | 432-433 |
| PEERS Tuckklemmen | 202 |

| | |
|---|---------------|
| PEET Splitterzangen | 151 |
| PEET TITE GRIP Splitterzangen | 151 |
| PELTESON Watteträger | 317 |
| Pelvishaken | 258 |
| PENFIELD Dura-Dissektoren | 699 |
| Penisklemmen | 426 |
| PENNINGTON Darm- und Gewebefaßzangen | 387 |
| PERCY Amputationsretraktoren | 571 |
| PERFECT-GRIP Mikro-Faßpinzetten | 124 |
| PERFECT-GRIP Mikro-Knüpfpinzetten | 121-123 |
| PERFECT-GRIP Mikro-Nadelhalter | 359, 361-362 |
| PERFECT-GRIP Nadelhalter | 364-365 |
| Perforatorium | 485 |
| Peripheralklemmen ATRAUMATIC-GRIP | 534-536, 558 |
| Peritoneal-Pneu-Kanülen | 329 |
| Peritoneumklemmen | 192-193 |
| Perkussionshämmer | 2-3 |
| PERMAN Bauchdeckenhalter | 299 |
| PERTHES Reibahlen | 650 |
| Phalangenmesser | 39 |
| PHANEUF Hysterektomieklappen | 194 |
| PIERCE Kieferhöhlentrockner | 319 |
| PIFFARD Lupusküretten | 20 |
| PINARD Stethoskop | 5 |
| Pinzetten, anatomisch | 132-134 |
| Pinzetten, Anlege- | 154, 156 |
| Pinzetten, ATRAUMATIC-GRIP, Gefäß- | 135 |
| Pinzetten, chirurgisch | 144-148 |
| Pinzetten, Cilien- | 152 |
| Pinzetten, Darm- | 149 |
| Pinzetten, Deckglas- | 152 |
| Pinzetten, Faden- | 152 |
| Pinzetten, Faß- | 149 |
| Pinzetten, fein, anatomisch | 128-131 |
| Pinzetten, fein, chirurgisch | 138-143 |
| Pinzetten, Gefäß- | 148-149 |
| Pinzetten, Gewebefaß- | 126-127, 148 |
| Pinzetten, Klammeranlage- | 379 |
| Pinzetten, Lungenfaß- | 149 |
| Pinzetten, Mikro- | 125 |
| Pinzetten, Mikro-, Faß- | 124 |
| Pinzetten, Mikro-, Knüpf- | 121-123 |
| Pinzetten, Mikro-, PERFECT-GRIP, Faß- | 124 |
| Pinzetten, Mikro- (Uhrmacher-Modelle) | 120 |
| Pinzetten, Mikroskopier- | 121 |
| Pinzetten, Nasen- | 136-137 |
| Pinzetten, Ohr- | 136-137 |
| Pinzetten, PERFECT-GRIP, Mikro-Knüpf- | 121-123 |
| Pinzetten, Splitter- | 150 |
| Pinzetten, TITE GRIP, anatomisch | 113-115 |
| Pinzetten, TITE GRIP, chirurgisch | 117-118 |
| Pinzetten, TITE GRIP, Gewebefaß- | 116 |
| Pinzetten, TITE GRIP, Knüpf- | 113 |
| Pinzetten, TITE GRIP, Mikro- | 118 |
| Pinzetten, TITE GRIP, Nadelzieh- | 116 |
| Pinzetten, Tumor- | 148-149 |
| Pinzetten, Tumorfaß- | 126-127 |
| Pinzetten, Wundnaht- | 378 |
| Pinzetten, zum Valvenwechsel | 289 |
| PIPER Geburtszange | 480 |
| Plazentarküretten | 484 |
| Plazentalöffel | 484 |
| Plazentanzangen | 482-483 |
| PLESTER Wundspreizer | 275 |
| Polypenzangen | 457 |
| POOLE Saugrohre | 325 |
| POTTS-DE BAKEY ATRAUMATIC-GRIP Patent-Ductusklemmen | 531 |
| POTTS-SMITH DURACUT Gefäßscheren | 56 |
| POTTS-SMITH Feine anatomische Pinzetten | 130 |
| POTTS-SMITH Feine chirurgische Pinzetten | 143 |
| POTTS-SMITH Gefäßscheren | 96-97 |
| POTTS-SMITH Präparierschere | 98 |
| POTTS-SMITH TITE GRIP Anatomische Pinzetten | 114 |
| POZZI Hakenzange | 453 |
| Präparierklappen | 180-189, 564 |
| Präparierklappen ATRAUMATIC-GRIP | 186, 551 |
| Präparierscheren | 81-91, 95, 98 |
| Präparierscheren DURACUT | 47-54 |
| Präparierscheren fein | 92-93 |

| | |
|---|--------|
| Präparierscheren, Mikro- | 65, 67 |
| PRATT Fistelsonden (Krypthaken) | 409 |
| PRATT Hakenzangen | 455 |
| PRATT Mastdarm-Rektum-Spekulum | 405 |
| PREP-LUBE Instrumenten-Pflegemittel | 733 |
| PRESBYTERIAN Schlauchklemme | 203 |
| PRICE-THOMAS Bronchusklemmen | 566 |
| Profundaklemmen ATRAUMATIC-GRIP | 534 |
| Prostatahaken | 422 |
| Prostatektomie Instrumente | 423 |
| PROVIDENCE-HOSPITAL Feine Arterienklappen | 168 |
| Proximalbeleuchtung-Kaltlicht für Amnioskop Tuben | 472 |
| Proximalbeleuchtung-Warmlicht für Amnioskop Tuben | 472 |
| Prüfinstrumente | 6 |
| PUTTI Raspeln | 594 |
| PVC-Schlauch zum Anschluß an Glaspipette | 473 |
| Pyloruspreizer | 403 |
| PYNCHON-ANDREW Saugrohr | 325 |

Q

| | |
|-----------------------------------|-----|
| QUERVAIN Elevator | 575 |
| QUINBY Zahnfleischschere | 94 |
| QUINKE Kanülen zur Lumbalpunktion | 328 |

R

| | |
|--|---------------------------|
| RABINER Perkussionshammer | 3 |
| RAGNELL-DAVIS Haken für plastische Chirurgie | 226 |
| RAGNELL DURACUT Präparierscheren | 49 |
| RAGNELL Präparierscheren | 83 |
| RALK Handbohrapparat | 653 |
| RALKS (VIRTUS) Splitterzange | 151 |
| RAMPLEY Tupfer- und Schwammzangen | 210 |
| RANDALL Endometrium-Saug-Biopsiekürette | 459 |
| RANDALL Nierensteinzangen | 420-421 |
| RANEY Klammerbock | 691 |
| RANEY Kopfhautklappen | 691 |
| RANKIN-CRILE-DE BAKEY ATRAUMATIC-GRIP Feine Arterienklappen | 167 |
| RANKIN-CRILE (OCHSNER-DIXON) Feine Arterienklappen | 167 |
| RANKIN-CRILE Feine Arterienklappen | 167 |
| RANKIN-KELLY Feine Arterienklappen | 169 |
| Rasierklappen-Halter und -Brecher | 36 |
| Raspatorien | 582-589, 694-695, 696-697 |
| Raspatorien mit Ferrozellgriff | 590-591 |
| Raspatorien, Rippen- | 495-497 |
| Raspeln | 592-595 |
| Raspeln TITE GRIP | 596-597 |
| RAY Küretten | 692 |
| RECAMIER Plazentar- und Abortusküretten | 484 |
| RECAMIER Uterusküretten | 468 |
| REDO Darmklappen | 390 |
| REDON Führungsadern | 334 |
| Reflexhämmer | 2-3 |
| Reflexspiegel | 10 |
| Reibahlen | 650 |
| REINER Gipsmesser | 679 |
| Reinigungsbürste für Trachealkanülen | 727 |
| Reinigungsbürsten | 756 |
| Rektum-Spekula | 405-406 |
| Rektumklappen | 400-402 |
| Rektumklappen ATRAUMATIC-GRIP | 400-401 |
| Rektumschere | 99 |
| Repositionszangen | 622-623 |
| RESANO ATRAUMATIC-GRIP Rektum-Anastomosenklemme | 401 |
| Resektionssäge | 38-39 |
| Resektionssägen | 572-573 |
| Retraktoren zur Fixation am OP-Tisch | 704-705 |
| Retraktoren zur Fixation am Schädel | 702-703 |
| Retraktoren, Amputations- | 571 |
| REVERDIN Bauch- und Darmspatel | 267 |
| REVERDIN Nadeln | 373 |
| REYNOLDS-COOLEY ATRAUMATIC-GRIP Anastomosenklappen | 559 |
| REYNOLDS-DE BAKEY ATRAUMATIC-GRIP Anastomosenklappen | 542 |
| REYNOLDS Feine Präparierscheren | 93 |
| REZEK-HEANEY Hysterektomieklappe | 196 |
| Rhinoskopspiegel | 14 |

| | |
|--|----------|
| RICARD Bauchdeckenhalter | 298 |
| RICHARDSON-EASTMAN Wundhaken | 250 |
| RICHARDSON Wundhaken | 251 |
| RICHTER-HEATH Klammerentfernungszange | 379 |
| RICHTER Operationsschere | 80 |
| RIENHOFF-FINOCCHIETTO Rippensperrerr | 506 |
| Rippenfaßzangen | 493 |
| Rippenkontraktoren | 508 |
| Rippenraspatorien | 495-497 |
| Rippenscheren | 492-493 |
| Rippensperrerr | 503-508 |
| Rippensperrerr aus ALUMINIUM | 500-502 |
| ROBB Intima-Spatel und -Dilatatoren | 512 |
| ROBERTS Arterienklemmen | 178 |
| ROBSON-MAYO ATRAUMATIC-GRIP Darmklemmen | 396 |
| ROBSON-MAYO Darmklemmen | 396 |
| ROCHARD Bauchdeckenhaken | 309 |
| ROCHESTER-CARMALT Arterienklemmen | 178 |
| ROCHESTER-OCHSNER Arterienklemmen | 178 |
| ROCHESTER-PEAN Arterienklemmen | 175 |
| ROEDER Tuchklemme | 201 |
| ROGERS (HEANEY-DE BAKEY) ATRAUMATIC-GRIP Hysterektomieklammern | 197 |
| ROGERS (WERTHEIM-DE BAKEY) ATRAUMATIC-GRIP Parametriumkanmmern | 197 |
| ROGGE Sterilisierzangen | 734 |
| ROLLET Wundhäkchen | 218 |
| Röntgen-Maßstab | 6 |
| ROSCHKE Analspreizer | 407 |
| ROSE Wundhaken | 227 |
| ROSEGGER-KLIMA Kanülen zur Sternalpunktion | 329, 518 |
| ROSEN Saugkanülen | 320 |
| ROSER-KÖNIG Mundsperrerr | 22 |
| RÖTTGEN-RUSKIN Hohlmeißelzange | 636 |
| ROUX-BABY Wundhaken | 228 |
| ROUX Wundhaken | 229 |
| RUDD Hämorrhoiden-Ligator | 410 |
| RUMEL-BELMONT Tourniquets | 518 |
| RUMEL-DE BAKEY ATRAUMATIC-GRIP Präparier- und Ligaturklemmen | 186 |
| RUMEL-DE BAKEY Präparier- und Ligaturklemmen | 186 |
| RUMEL Präparier- und Ligaturklemmen | 186 |
| Rundmeißelzange | 494 |
| RUSKIN-LISTON Knochensplitterzangen | 638 |
| RUSKIN-RÖTTGEN Hohlmeißelzange | 636 |
| RUSKIN-STILLE Hohlmeißelzange | 636 |
| RUSKIN Hohlmeißelzangen | 633-634 |
| RUSKIN Knochensplitterzangen | 638 |
| RUSS. MODELL Gefäß- und Tumorzangen | 149 |
| RUST Amputations- und Resektionssäge | 573 |
| RYDEL-SEIFFER Stimmgabel | 4 |
| RYDER-LANGENBECK TITE GRIP Nadelhalter | 350 |
| RYDER-VASCULAR TITE GRIP Nadelhalter | 340 |
| RYDER TITE GRIP Nadelhalter | 340 |

S

| | |
|---|---------|
| SAALFELD Komedonenquetscher | 19 |
| SACHS Dura-Separatoren | 698 |
| SACHS Durahäkchen | 217 |
| SACHS Fistelhaken | 221 |
| SACHSE Meatotom | 426 |
| SAENGER Plazentar- und Abortuszangen | 483 |
| Sägen, Amputations- | 572-573 |
| Sägen, Draht- | 687 |
| Sägen, Fingerring- | 645 |
| Sägen, Gips- | 679 |
| Sägen, Resektions- | 572-573 |
| SALENIUS Meniskusmesser | 642 |
| SALING Amnioskop-Tuben | 472 |
| Salpingographie | 474 |
| SAMII-YASARGIL Tumor- und Gewebefaßpinzetten | 126 |
| SAMII Tumor- und Gewebefaßpinzetten | 127 |
| SANVENERO Scheren für plastische Chirurgie | 70 |
| SAROT Bronchusklemmen | 566 |
| SAROT Feine Arterienklemmen | 171 |
| SAROT TITE GRIP Nadelhalter | 344 |
| SATINSKY-BABY Anastomosen- (Vena Cava) Klemme | 565 |
| SATINSKY-DE BAKEY ATRAUMATIC-GRIP Bulldogklemmen | 525 |

| | |
|---|------------------|
| SATINSKY-DE BAKEY ATRAUMATIC-GRIP Gefäßklemmen | 541 |
| SATINSKY Anastomosen- (Vena Cava) Klemmen | 565 |
| SATINSKY Vena Cava-Schere | 99 |
| SATTERLEE Amputations- und Resektionssäge | 572 |
| SAUER Feine chirurgische Pinzetten | 138 |
| SAUERBRUCH-FREY Rippenschere | 493 |
| SAUERBRUCH-SCHNEIDER Raspatorium | 588 |
| SAUERBRUCH Abfallzange | 735 |
| SAUERBRUCH Nadel-Sterilisierdosen | 357 |
| SAUERBRUCH Rippenschere | 492 |
| SAUERBRUCH Wundhaken | 242 |
| Saughandgriff für ROSEN Saugkanülen | 320 |
| Saugkanülen | 320-323 |
| Saugrohre | 324-327 |
| Saugrohre, Nasen- | 324 |
| SCALP CONTOUR Wundspreizer | 276 |
| Scapula-Haken | 260 |
| SCHAAF Cilienpinzette | 152 |
| SCHÄDEL Tuchklemmen | 200 |
| Schädelhalter | 689 |
| Schädelöffnungsinstrumente | 687 |
| Schädelstanze | 688 |
| Schädelzangen | 688 |
| Schalen | 748 |
| Schalen, Dreieck- | 750 |
| Schalen, Nieren- | 750 |
| Schalen, Spül- | 749 |
| SCHAMBERG Komedonenquetscher | 19 |
| Scharfe Löffel | 598-606, 695-696 |
| Scharfe Löffel mit Ferrozellgriff | 606 |
| SCHUDE Scharfe Löffel | 602 |
| Scheidenhalter | 434-437, 439 |
| Scheidenspekula | 430-442 |
| SCHERBACK Scheidenspekula | 442 |
| Scheren, Arteriotomie- | 95 |
| Scheren, Bauchdecken- | 106 |
| Scheren, chirurgisch | 71-83 |
| Scheren, chirurgisch fein | 68-70 |
| Scheren, Coronararterien- | 95 |
| Scheren, Damm- (Episiotomie-) | 107 |
| Scheren, Darm- | 109 |
| Scheren, Draht- | 665 |
| Scheren, Dura- | 100 |
| Scheren, DURACUT, Adnex- | 54 |
| Scheren, DURACUT, chirurgisch | 46 |
| Scheren, DURACUT, Damm- (Episiotomie-) | 60 |
| Scheren, DURACUT, Draht- | 665 |
| Scheren, DURACUT fein | 45 |
| Scheren, DURACUT, Fistel- | 45 |
| Scheren, DURACUT für plastische Chirurgie | 45 |
| Scheren, DURACUT für Rektumchirurgie | 59 |
| Scheren, DURACUT, Gefäß- | 45, 56-57 |
| Scheren, DURACUT, Gips- | 676 |
| Scheren, DURACUT, Gynäkologische | 60 |
| Scheren, DURACUT, Iris- | 45 |
| Scheren, DURACUT, Ligatur- | 353 |
| Scheren, DURACUT, Nasen- | 58 |
| Scheren, DURACUT, Parametrium- | 60 |
| Scheren, DURACUT, Präparier- | 47-54 |
| Scheren, DURACUT, Septum- | 59 |
| Scheren, DURACUT, Uterus- | 60 |
| Scheren, DURACUT, Verband- | 673 |
| Scheren, DURACUT, Zahnfleisch- | 55 |
| Scheren, Faden- | 352 |
| Scheren, fein, Präparier- | 92-93 |
| Scheren, fein, Sehnen- | 92 |
| Scheren, Fistel- | 80 |
| Scheren für die Nervenpräparation | 93 |
| Scheren für Lungenlappen | 99 |
| Scheren für Neurochirurgie | 100 |
| Scheren für plastische Chirurgie | 70, 82 |
| Scheren für Vena Cava | 99 |
| Scheren, Gefäß- | 80, 95-98 |
| Scheren, Gips- | 675-678 |
| Scheren, Inzisions- | 80 |
| Scheren, Kephalotomie- | 109 |
| Scheren, Kleiderstoff- | 674-675 |
| Scheren, Knorpel- | 82 |
| Scheren, Ligatur- | 352-353 |

| | |
|--|---------------|
| Scheren, Mikro- | 62-67 |
| Scheren, Mikro-, Präparier- | 65, 67 |
| Scheren, Nabelschnur- | 108 |
| Scheren, Nagel- | 16 |
| Scheren, Nagelhaut- | 16 |
| Scheren, Nagelspalt- | 81 |
| Scheren, Nasen- | 101-102 |
| Scheren, Nasenflügel- | 81 |
| Scheren, Operations- | 80 |
| Scheren, Präparier- | 81-91, 95, 98 |
| Scheren, Rektum- | 99 |
| Scheren, Rippen- | 492-493 |
| Scheren, Septum- | 103 |
| Scheren, Tonsillen- | 103 |
| Scheren, Trigeminus- | 100 |
| Scheren, Uterus- | 104-106 |
| Scheren, Venen- | 63 |
| Scheren, Verband- | 672-674 |
| Scheren, Zahnfleisch- | 94 |
| Schieblehre | 7 |
| Schielhaken | 213 |
| Schilddrüsenhaken | 243 |
| SCHINK Dermatome | 41 |
| Schlauch- und Katheter-Führungszange | 473 |
| Schlauch, Stau- | 570 |
| Schlauch-PVC zum Anschluß an Gaspipette | 473 |
| Schlauchklemmen | 203 |
| Schlauchroller | 203 |
| Schlauchverbindungsstück für ROSEN Saugkanülen | 320 |
| SCHMID Gefäßspülkanülen | 322 |
| SCHMID Intima-Spatel | 513 |
| SCHMIEDEN-TAYLOR Duraschere | 100 |
| SCHMIEDEN Führungshohlsonde | 378 |
| SCHNEIDER-SAUERBRUCH Raspatorium | 588 |
| SCHNEIDER Raspatorium | 588 |
| Schneidezangen | 666 |
| SCHNIDT Arterien- und Tonsillenklemmen | 179 |
| SCHOEMAKER-LOTH Ligatur- und Fadenschere | 352 |
| Schreibgeräte | 757 |
| SCHRÖDER Hakenzangen | 452, 454 |
| SCHRÖDER Uteruslöffel | 466 |
| SCHUBERT Uterus-Biopsiezangen | 461 |
| SCHULTZE Salpingographie | 474 |
| SCHUMACHER Nabelschnurschere | 108 |
| SCHUMACHER Uterus-Biopsiezangen | 463 |
| Schüsseln, Wasch- | 749 |
| Schwammzangen | 209-210 |
| SCHWARTZ Anlegezange für Gefäßclips | 155 |
| SCHWARTZ Gefäßclips | 155 |
| Schwesterngarnitur | 18 |
| SCOVILLE-HAVERFIELD Laminektomie-Spreizer | 286 |
| SCOVILLE (OLIVECRONA-TOENNIS) Klammer-Anlegezangen für Silberklammern | 690 |
| SCOVILLE Haken für Wundspreizer | 287 |
| SCOVILLE Laminektomie-Spreizer | 286 |
| SCOVILLE Nervwurzelhaken | 701 |
| SCOVILLE Seitenvalven für Wundspreizer | 287 |
| SCUDDER ATRAUMATIC-GRIP Magenklemmen | 397 |
| SEALY Feine chirurgische Scheren | 68 |
| SEBILEAU Elevator | 575 |
| SEDILLOT Raspatorien | 586 |
| SEGOND Hysterektomieklemmen | 195-196 |
| Sehnedurchziehungen | 649 |
| Sehneneinflechtungsklemmen | 649 |
| Sehnenfaßzangen | 647 |
| Sehnenführer | 646 |
| Sehnenführungszangen | 648 |
| Sehnenschäler | 646 |
| Sehnenscheidenhaken | 225 |
| Sehnenscheren fein | 92 |
| Seitenschneider | 668 |
| SEIFFER-RYDEL Stimmgabel | 4 |
| Seitenvalven für SCOVILLE Wundspreizer | 287 |
| Seitenvalven für TAYLOR Wundspreizer | 287 |
| Sekretlöffel | 425 |
| SELETZ-GELPI Vulva-Spreizer | 281 |
| SELLHEIM Geburtslöffel | 481 |
| SELLORS Rippensperrer und -kontraktor | 508 |
| SEMB Hohlmeißelzange | 494 |
| SEMB Knochensplitterzange | 494 |
| SEMB Lungenhaken | 260 |
| SEMB Präparier- und Ligaturklemmen | 564 |
| SEMB Rippen- und Knochenfaßzangen | 493 |
| SEMB Rippenraspatorien | 496 |
| SEMKEN Feine anatomische Pinzetten | 130 |
| SEMKEN Feine chirurgische Pinzetten | 142 |
| SEMKEN TITE GRIP Anatomische Pinzette | 113 |
| SEMKEN TITE GRIP Chirurgische Pinzetten | 117 |
| SEMM Bauchdeckenhalter | 305 |
| SEMM Scheidenspekula | 432 |
| SENN-GREEN Wundhaken | 224 |
| SENN-MILLER Wundhaken | 226 |
| Sensibilitätsinstrumente | 4 |
| Separatoren-Dura | 698 |
| Septumkanülen | 328 |
| Septumschere | 102 |
| Septumscheren DURACUT | 59 |
| Sequesterzangen | 623 |
| SEUTIN Kleiderstoff- und Gipsscheren | 675 |
| SEWALL Raspatorien | 582 |
| Seziermesser | 40 |
| SHAMBAUGH Wundhaken | 212 |
| SIEBOLD-SIMS Uterusschere | 106 |
| SIEBOLD Uterusschere | 106 |
| Siebschalen für Sterilisation | 744 |
| Silberdraht | 690 |
| Silberklammern | 690 |
| SILVER Dermatome | 41 |
| SIMON-HEANEY Wundhaken | 254 |
| SIMON Fistelhaken | 221 |
| SIMON Scharfe Löffel | 605 |
| SIMON Uteruslöffel | 466 |
| SIMON Wundhaken | 254 |
| SIMPSON-BRAUN Geburtszangen | 478 |
| SIMPSON Uterussonden | 446 |
| SIMS-MAIER Korn- und Tupferzangen | 205 |
| SIMS-SIEBOLD Uterusschere | 106 |
| SIMS DURACUT Uterusscheren | 60 |
| SIMS Mastdarm-Rektum-Spekula | 405-406 |
| SIMS Scheidenspekula | 438 |
| SIMS Uterusküretten | 467 |
| SIMS Uterusscheren | 104-105 |
| SIMS Uterussonden | 446 |
| SINGLEY (TUTTLE) Lungenfaßpinzetten | 149 |
| Sinusklemmen | 204 |
| Skalpelloffeln | 34-35 |
| Skalpelloffeln | 34-35 |
| SMELLIE Perforatorium | 485 |
| SMILLIE Meniskusmesser | 643 |
| SMILLIE Wund- und Meniskushaken | 641 |
| SMITH-BUIE Analspreizer | 408 |
| SMITH-FERRIS-CUSHING Laminektomie-Zangen | 713 |
| SMITH-FERRIS Chirurgische Pinzetten | 147 |
| SMITH-HEYWOOD Zungenzangen | 23 |
| SMITH-KERRISON-FERRIS Laminektomie-Stanzen | 709-710, 712 |
| SMITH-POTTS DURACUT Gefäßscheren | 56 |
| SMITH-POTTS Feine anatomische Pinzetten | 130 |
| SMITH-POTTS Feine chirurgische Pinzetten | 143 |
| SMITH-POTTS Gefäßscheren | 96-97 |
| SMITH-POTTS Präparierschere | 98 |
| SMITH-POTTS TITE GRIP Anatomische Pinzetten | 114 |
| SMITH Verbandscheren | 672 |
| SOFT-GREGORY ATRAUMATIC-GRIP Karotisklemmen | 527 |
| SOMER Uterusfaßzange | 458 |
| Sonden | 312-314 |
| Sonden, Anal- | 409 |
| Sonden, Doppel- | 694 |
| Sonden, Fistel- | 314, 409 |
| Sonden, Führungshohl- | 377-378 |
| Sonden, für Laserchirurgie | 450-451 |
| Sonden, für Laserchirurgie, Meß- | 450 |
| Sonden, Gallengang- | 415 |
| Sonden, Gallenstein- | 415 |
| Sonden, Hohl- | 314 |
| Sonden, Knopf- | 312-313, 694 |
| Sonden, Kropf- | 378 |
| Sonden, Myrtenblatt- | 313 |
| Sonden, Ohr- | 313 |

| | |
|---|---------------------------|
| Sonden, Tränenkanal- | 312 |
| Sonden, Uterus- | 446 |
| Spatel, Bauch- | 266-267 |
| Spatel, Blasen- | 268 |
| Spatel, Darm- | 266-267 |
| Spatel, Hirn- | 706 |
| Spatel, Intima- | 512-513 |
| Spatel, Lungen- | 260-265 |
| Spekula für Laserchirurgie, Endo- | 448 |
| Spekula für lumbale Bandscheibenoperationen | 295 |
| Spekula für trans-sphenoidale Hypophysektomie | 692 |
| Spekula, Endo- | 443 |
| Spekula, Mastdarm- | 405-406 |
| Spekula, Rektum- | 405-406 |
| Spekula, Scheiden- | 430-442 |
| Spekulum für Laserchirurgie, Lateral- | 448 |
| SPENCER-WELLS Arterienklemmen | 173 |
| SPENCER (NORTHBENT) Ligatur- und Fadenscheren | 352 |
| SPENCER Ligatur- und Fadenscheren | 352 |
| Spender, Bürsten- | 752 |
| Sperrer aus ALUMINIUM, Rippen- | 500-502 |
| Sperrer aus ALUMINIUM, Sternotomie- | 498 |
| Sperrer, Rippen- | 503-508 |
| Sperrer, Sternotomie- | 499 |
| Sperrer, Thorax- | 507 |
| Spezialkanülen | 328 |
| Sphinkteroskope | 407 |
| Spinal-Hohlmeißel mit Ferrozellgriff | 616 |
| Splitterpinzetten | 150 |
| Splitterzangen | 151 |
| Splitterzangen TITE GRIP | 151 |
| Spongiosa-Hohlmeißel mit Ferrozellgriff | 615 |
| Spornquetsche | 403 |
| SPRATT Scharfe Löffel | 602 |
| Spreizer, Anal- | 407-408 |
| Spreizer, Blasenhals- | 423 |
| Spreizer, Gips- | 682 |
| Spreizer, Pylorus- | 403 |
| Spreizer, Vulva- | 281 |
| Spreizer, Wirbelkörper- | 296 |
| Spreizer, Wund- | 270-280, 282-285, 287-294 |
| Spritzen | 330-332 |
| Spritzen, Insulin- | 330 |
| Spritzen, Ohr- | 332 |
| Spritzen, Tuberkulin- | 330 |
| Spritzen, Wund- und Blasen- | 331 |
| Spülschalen | 749 |
| SPURLING Laminektomie-Zangen | 717 |
| Sputumbecher | 751 |
| ST. MARKS Pelvishaken | 258 |
| ST. MARTIN feine chirurgische Pinzette | 139 |
| STACKE Knopfsonde | 313 |
| STADLER-BRAUN Damm- (Episiotomie-) Scheren | 107 |
| Stahlmaßband | 6 |
| Stahlmaßstäbe | 6 |
| STANDARD-YASARGIL Anlegepinzetten | 154 |
| STANDARD-YASARGIL Gefäßclips | 154 |
| Standgefäße | 747 |
| Stanzen, Haut- | 20 |
| Stanzen, Laminektomie- | 707-712 |
| Stanzen, Schädel- | 688 |
| Staubbinde | 570 |
| STAUDE-MOORE Hakenzange | 452 |
| Stauschlauch | 570 |
| Stechbecken | 750 |
| STEINMANN Nägel | 654 |
| STEINMANN Sehnenfaßzange | 647 |
| STELLBRING Hohlmeißelzangen | 632 |
| STELZNER (CRAFOORD) Lungenlappen- und Rektumschere | 99 |
| Sterilisier-Körbe | 745 |
| Sterilisier-Siebschalen | 744 |
| Sterilisierbehälter | 738-742 |
| Sterilisierdosen für Nadeln | 357 |
| Sterilisiergestelle für Nadeln | 736 |
| Sterilisiergestelle für Ringinstrumente | 736 |
| Sterilisierklammern | 736 |
| Sterilisierrahmen für Mikro-Instrumente | 737 |
| Sterilisiertrommeln | 743 |
| Sterilisierzangen | 734 |

| | |
|---|----------|
| Sternotomie-Sperrer | 499 |
| Sternotomie-Sperrer aus ALUMINIUM | 498 |
| Sternnummeißel | 492 |
| Stethoskope | 5 |
| STEVENS Feine Präparier- und Sehnenscheren | 92 |
| STIEGLIZT (WILLIAMS) Splitterzangen | 151 |
| STILLE-BARRAYA Gefäß- und Tumorzinnetten | 148 |
| STILLE-CRAFOORD Feine Arterienklemmen | 170 |
| STILLE-DOYEN Wundhaken | 247 |
| STILLE-GIERTZ Rippenschere | 492 |
| STILLE-LEKSELL Hohlmeißelzangen | 635 |
| STILLE-LUER Hohlmeißelzangen | 634, 636 |
| STILLE-MAYO DURACUT Präparierscheren | 48 |
| STILLE-MAYO Präparierscheren | 85 |
| STILLE-MINI Gipsscheren | 677 |
| STILLE-RUSKIN Hohlmeißelzange | 636 |
| STILLE-STRANDELL Sehnenscheidenhaken | 225 |
| STILLE Flachmeißel | 610 |
| STILLE Gipsscheren | 677-678 |
| STILLE Handbohrapparat | 651 |
| STILLE Hohlmeißel | 610 |
| STILLE Hohlmeißelzange | 635 |
| STILLE Osteotome | 610 |
| Stimmgabeln | 4 |
| Stirnbänder | 10 |
| Stirnlampen | 11 |
| Stirnspiegel | 10 |
| STOCKMANN Penisklemme | 426 |
| Stößel | 606 |
| Stößel mit Ferrozellgriff | 606 |
| STRANDELL-STILLE Sehnenscheidenhaken | 225 |
| STRATTE TITE GRIP Nadelhalter | 347 |
| STRAUSS Penisklemme | 426 |
| STRULLY Neurochirurgische Scheren | 100 |
| SUBRAMANIAN ATRAUMATIC-GRIP Aortaklemmen | 537 |
| SULLIVAN (BROPHY) Feine Präparierscheren | 93 |
| SUPER Stethoskop | 5 |
| SWEET-LAHEY Präparier- und Ligaturklemme | 189 |
| SWITZERLAND MOD. Mikro-Pinzetten (Uhrmacher Modelle) | 120 |
| SYSTRUNK Nagelspaltschere | 81 |

T

| | |
|--|---------------|
| TAKAHASHI Laminektomie-Zangen | 714 |
| Tamponadeführer | 447 |
| Tamponzangen | 208 |
| TARNIER Geburtszange | 480 |
| TAYLOR-CUSHING Feine anatomische Pinzetten | 130 |
| TAYLOR-CUSHING Feine chirurgische Pinzette | 143 |
| TAYLOR-CUSHING Ohr- und Nasenpinzetten | 136 |
| TAYLOR-CUSHING TITE GRIP Anatomische Pinzette | 114 |
| TAYLOR-SCHMIEDEN Duraschere | 100 |
| TAYLOR Perkussionshammer | 2 |
| TAYLOR Seitenvälvn für Wundspreizer | 287 |
| TEALE Hakenzangen | 456 |
| Tenotom | 37 |
| THOMAS-PRICE Bronchusklemmen | 566 |
| THOMS-ALLIS Darm- und Gewebefaßzange | 385 |
| THOMS-GAYLOR Uterus-Biopsiezange | 460 |
| Thoraxklemme | 564 |
| Thoraxsperrer | 507 |
| THOREK-METZENBAUM DURACUT Adnexscheren | 54 |
| THOREK Präparierscheren | 98 |
| THORLAKSON ATRAUMATIC-GRIP Obere Verschußklemme | 398 |
| THORLAKSON ATRAUMATIC-GRIP Untere Verschußklemmen | 399 |
| THORLAKSON Wundhaken | 230, 256-257 |
| Tiefenmesser für Laserchirurgie | 451 |
| TISCHLER-BABY Uterus-Biopsiezange | 464 |
| TISCHLER-MORGAN Uterus-Biopsiezange | 464 |
| TISCHLER Uterus-Biopsiezangen | 465 |
| TITAN-LINE Bulldogklemmen aus Titan | 160-161 |
| TITAN-LINE Feine Arterienklemmen | 164, 166, 168 |
| TITE GRIP Chirurgische Pinzetten | 117-118 |
| TITE GRIP Darmfaßzangen | 388 |
| TITE GRIP Drahtfaßzangen | 663 |
| TITE GRIP Drahtspannzangen | 662 |
| TITE GRIP Gewebefaß-Pinzetten | 116 |
| TITE GRIP Gewebefaßzangen | 388 |
| TITE GRIP Knüpfpinzetten | 113 |

| | |
|---|-------------------|
| TITE GRIP Mikro-Nadelhalter | 338-339 |
| TITE GRIP Mikro-Pinzetten | 118 |
| TITE GRIP Nadelhalter | 340-350 |
| TITE GRIP Nadelhalter für Linkshänder | 341 |
| TITE GRIP Nadelzieh-Pinzetten | 116 |
| TITE GRIP Pinzetten, anatomisch | 113-115 |
| TITE GRIP Raspeln | 596-597 |
| TITE GRIP Splitterzangen | 151 |
| TOENNIS-ADSON DURACUT Präparierscheren | 49 |
| TOENNIS-ADSON Präparierscheren | 89 |
| TOENNIS-OLIVECRONA (SCOVILLE) Klammer-Anlegezangen für Silberklammern | 690 |
| TOENNIS Dura-Dissektoren | 700 |
| TOENNIS Nadelhalter | 371 |
| TOENNIS Präparierscheren | 83 |
| TOENNIS TITE GRIP Nadelhalter | 350 |
| TOHOKU Tuchklammern | 202 |
| TÖNNIS Duramesser | 37 |
| Tonsillenkanülen | 328 |
| Tonsillenklemmen | 179 |
| Tonsillenscheren | 103 |
| Tourniquets | 518 |
| TOWNSEND Uterus-Biopsiezangen | 465 |
| Trachealdilatator | 728 |
| Trachealhäkchen | 217, 219-220, 728 |
| Trachealhaken | 226 |
| Trachealkanülen | 725-727 |
| Tracheotomiebestecke | 729-730 |
| Tracheotomieinstrumente | 728 |
| Tracheotomietrokar für Notfälle | 728 |
| Tränenkanalsonden | 312 |
| Transformator | 472 |
| Transformator, klein für Stirnlampen | 11 |
| TRELAT Raspatorien | 582 |
| TRELAT Scheidenspekula | 431 |
| Trichter | 751 |
| Trigeminus-Schere | 100 |
| TROELTSCH (WILDE) Ohr- und Nasenpinzetten | 137 |
| TROELTSCH Ohr- und Nasenpinzetten | 137 |
| TROEMNER Perkussionshammer | 3 |
| Trokare | 318 |
| Trokare, Gallenblasen- | 318 |
| Trokare, Kieferhöhlen- | 319-320 |
| Trokare, Not-Tracheotomie- | 728 |
| TROUSSEAU Trachealdilatator | 728 |
| TROUTMAN-BARRAQUER Mikro-Nadelhalter | 360 |
| TROUTMANN Rasierklingen-Halter und -Brecher | 36 |
| TUBBS Aorta-Dilatator | 511 |
| Tuberkulin-Spritze | 330 |
| Tuchklammern | 200-202 |
| TUFFIER Bauch- und Darmspatel | 267 |
| TUFFIER Rippensperrerr | 506 |
| Tumorfaspinzetten | 126-127 |
| Tumorpinzetten | 148-149 |
| Tunnelier-Instrumente | 517 |
| Tunnelier-Satz | 516 |
| TUOHY Kanülen zur Lumbalpunktion | 328 |
| Tupferträger | 473 |
| Tupferzangen | 204-207, 209-210 |
| TUTTLE (SINGLEY) Lungenfaspinzetten | 149 |
| TYRELL (GRAEFE) Hauthäkchen (Irishäkchen) | 216 |

U

| | |
|---|---------|
| UCKERMANN Watteträger | 317 |
| UECKERMANN-DENKER Not-Tracheotomietrokare | 728 |
| UFFENORDE Scharfe Löffel | 601 |
| ULRICH Fistelmesser | 37 |
| ULRICH Knochenhalte-zangen | 627 |
| ULRICH Korn- und Tupferzangen | 206 |
| UNIVERSAL Drahtscheren | 665 |
| UNIVERSAL DURACUT Drahtscheren | 665 |
| UNIVERSAL Trokare | 318 |
| UNNA-VIDAL Komedonenquetscher | 19 |
| UNNA Komedonenquetscher | 19 |
| Unterarm-Wundspreizer | 271 |
| Unterbindungsnadeln | 374-376 |
| Untere Verschlussklemmen ATRAUMATIC-GRIP | 399 |

| | |
|---------------------------------------|---------|
| Urethrographie-Instrument | 426 |
| Urologie-Instrumente | 425-426 |
| US-ARMY (PARKER-LANGENBECK) Wundhaken | 231 |
| USA MOD. Anatomische Pinzetten | 133 |
| USA MOD. Chirurgische Pinzetten | 145 |
| USA MOD. Gipsspreizer | 682 |
| USA MOD. Nabelschnurschere | 108 |
| USA MOD. Scharfe Löffel | 601 |
| Uterus-Biopsiezange | 460-465 |
| Uterus-Depressor | 447 |
| Uterus-Dilatatoren | 443-445 |
| Uterusfaßzangen | 458 |
| Uterusklemmzange | 481 |
| Uterusküretten | 466-470 |
| Uteruslöffel | 466 |
| Uterusscheren | 104-106 |
| Uterusscheren DURACUT | 60 |
| Uterussonden | 446 |

V

| | |
|--|--------------|
| VALLEIX Uterussonden | 446 |
| Valven für BALFOUR Bauchdeckenhalter | 303 |
| Valven für HENLEY Wundspreizer | 283 |
| Valven für KIRSCHNER-BALFOUR Bauchdeckenhalter | 307 |
| Valven für KIRSCHNER Bauchdeckenhalter | 307 |
| Valven für SCOVILLE Wundspreizer | 287 |
| Valven für Wundspreizer | 289, 293 |
| VAN BUREN Dilatationsbougies | 424 |
| VAN BUREN Sequesterzangen | 623 |
| VAN DOREN Uterus-Biopsiezange | 461 |
| VANNAS-YASARGIL Mikro-Scheren | 66 |
| VANNAS Mikro-Scheren | 62-63, 65 |
| VANNAS MOD. TÜBINGEN Mikro-Scheren | 62 |
| VARCO Feine Arterienklemme | 170 |
| VASCULAR-RYDER TITE GRIP Nadelhalter | 340 |
| VASCULAR PERFECT-GRIP Nadelhalter | 364-365 |
| Vena Cava-Klemmen ATRAUMATIC-GRIP | 550 |
| Vena Cava-Schere | 99 |
| Venenhaken | 217, 222-223 |
| Venenschere | 63 |
| Venenstripper | 315 |
| Ventil-Sprechkanülen | 726-727 |
| Verbandscheren | 672-674 |
| Verbandscheren DURACUT | 673 |
| Verbindungsstücke für Spritzen | 333 |
| VERBRUGGE-MÜLLER Knochenhebel | 579 |
| VERBRUGGE Knochenhalte-zangen | 628 |
| VERESS Peritoneal-Pneu-Kanülen | 329 |
| VERNET-GIL (MARBERGER) Venen- und Hilushaken | 223 |
| VICKERS Finger-Wundspreizer | 270 |
| VICKERS Hand- und Carpal- Tunnel-Wundspreizer | 271 |
| VICKERS Hand- und Unterarm-Wundspreizer | 271 |
| VICKERS Handhalter | 644 |
| VICKERS Mehrfach-Bohrdrahtspender | 657 |
| VIDAL-UNNA Komedonenquetscher | 19 |
| VIDAL Lupusschaber | 19 |
| VIRCHOW Hirnmesser | 40 |
| VIRTUS (RALKS) Splitterzange | 151 |
| WISE Mikro-Knüpfpinzetten | 122 |
| VOGEL Kieferhöhlenpunktionskanülen | 319 |
| VOLKMANN Scharfe Löffel | 600, 602 |
| VOLKMANN Scharfe Löffel mit Ferrozellgriff | 606 |
| VOLKMANN Wund- und Knochenhaken | 232 |
| VOLKMANN Wundhaken | 233-234 |
| VON PETZ Magen- und Darm-Nähapparat | 404 |
| Vorbohrer für Schädelhalter | 689 |
| Vulva-Spreizer | 281 |

W

| | |
|--|-----|
| WAGENER Ohrhäkchen | 213 |
| WAGNER Hammer | 620 |
| WAGNER Knochenhebel | 577 |
| WAGNER Raspatorien mit Ferrozellgriff | 591 |
| WALB Organmesser | 40 |
| WALDMANN Damm- (Episiotomie-) Scheren | 107 |
| WALTON-LISTON (BÖHLER) Knochensplitterzangen | 638 |

| | |
|---|---------------------------|
| WANGENSTEEN Nadelhalter | 369 |
| WANGENSTEEN TITE GRIP Anatomische Pinzetten | 115 |
| WANGENSTEEN TITE GRIP Nadelhalter | 347 |
| Warmlicht-Proximalbeleuchtung für Amnioskop Tuben | 472 |
| WARTENBERG Algesimeter | 4 |
| Waschschüsseln | 749 |
| Wasserstrahlreinigungspistole | 754-755 |
| WATSON-CHEYNE Dissektor | 574 |
| WATSON-WILLIAMS Raspel | 593 |
| Watteträger | 409, 316-317, 473 |
| WAUGH Feine anatomische Pinzette | 130 |
| WAUGH Feine chirurgische Pinzette | 143 |
| WEBER Ästhesiometer | 4 |
| WEBER ATRAUMATIC-GRIP Aorta-Anastomosenklemmen | 548 |
| WEBSTER Nadelhalter | 363 |
| WEBSTER TITE GRIP Nadelhalter | 342 |
| WEIL-BLAKESLEY Laminektomie-Zangen | 714 |
| WEISSBARTH Scheidenspekulum | 442 |
| WEITLANER Wundspreizer | 272-274 |
| WELLS-SPENCER Arterienklemmen | 173 |
| WERTHEIM-CULLEN Nierenstieltklemme | 191 |
| WERTHEIM-DE BAKEY (ROGERS) ATRAUMATIC-GRIP Parametriumklemmen | 197 |
| WERTHEIM (BOZEMANN) TITE GRIP Nadelhalter | 346 |
| WERTHEIM Hysterektomieklammern | 194-195 |
| WERTHEIM Uterusscheren | 105 |
| WEST Flachmeißel | 607 |
| WEST Hohlmeißel | 607 |
| WIENER MOD. Fadenfänger | 378 |
| WIENER Raspeln | 593 |
| WILDE (TROELTSCH) Ohr- und Nasenpinzetten | 137 |
| WILLETT Kopfschwartenzange | 481 |
| WILLIAMS-WATSON Raspel | 593 |
| WILLIAMS (STIEGLITZ) Splitterzangen | 151 |
| WILLIAMS Darm- und Gewebefaßzange | 388 |
| WILLIGER Elevatorien | 574 |
| WILLIGER Hammer | 617 |
| WILLIGER Raspatorien | 582 |
| WILLIGER Scharfe Löffel | 598, 600 |
| Winkelmesser | 7 |
| WINTER Plazentare- und Abortuszangen | 482 |
| WINTER Stethoskop | 5 |
| Wirbelkörper-Biopsieinstrumentarium | 720-721 |
| Wirbelkörperspreizer | 296 |
| WITTNER Uterus-Biopsiezangen | 462 |
| WOLFF Gipsabreißzangen | 682 |
| WOLFSON-DE MARTEL Dickdarm-Anastomosen-Klemmen | 402 |
| WOLFSON-DE MARTEL Klemmenhalter | 402 |
| WOLFSON-DE MARTEL Klemmenschießzange | 402 |
| WOOD-CRILE Nadelhalter | 366, 368 |
| WOOD-CRILE TITE GRIP Nadelhalter | 343 |
| WOOD-CRILE TITE GRIP Nadelhalter für Linkshänder | 341 |
| WRIGLEY Geburtszange | 480 |
| WULLSTEIN Mikro-Absaugrohr | 321 |
| WULLSTEIN Saugkanüle | 322 |
| WULLSTEIN Wundspreizer | 275 |
| Wundhäkchen | 212, 216-221 |
| Wundhaken | 222-259, 261-265, 641 |
| Wundhaken, Kropf- | 224 |
| Wundklammern | 379 |
| Wundnahtbesteck | 380 |
| Wundnahtpinzette | 378 |
| Wundspreizer | 270-280, 282-285, 287-294 |
| Wundspreizer für die Wirbelsäule | 285, 288, 290-292, 294 |
| Wundspreizer, Appendektomie- | 284 |
| Wundspreizer, Blasen- | 310 |
| Wundspreizer, Finger- | 270 |
| Wundspreizer, Hand- und Carpal- Tunnel- | 271 |
| Wundspreizer, Hand- und Unterarm- | 271 |
| Wundspreizer, Hemilaminektomie- | 277 |
| Wundspreizer, Laminektomie- | 276, 279-280, 284, 286 |
| Wundspritzen | 331 |
| WYLIE ATRAUMATIC-GRIP Aorta-Anastomosenklemmen | 549 |

Y

| | |
|--------------------------------------|---------|
| YANKAUER Saugrohre | 325-326 |
| YASARGIL-MINI Anlegepinzetten | 154 |

| | |
|---|----------|
| YASARGIL-MINI Gefäßclips | 154 |
| YASARGIL-SAMII Tumor- und Gewebefaßpinzetten | 126 |
| YASARGIL-STANDARD Anlegepinzetten | 154 |
| YASARGIL-STANDARD Gefäßclips | 154 |
| YASARGIL-VANNAS Mikro-Scheren | 66 |
| YASARGIL Dissektoren | 694 |
| YASARGIL Fadenführer | 697 |
| YASARGIL Federhaken zur Galea-Fixation | 691 |
| YASARGIL Gefäßmesser | 695 |
| YASARGIL Hypophysenzange | 719 |
| YASARGIL Mikro-Pinzetten | 125 |
| YASARGIL Mikro-Präparierscheren | 67 |
| YASARGIL Mikro-Scheren | 66-67 |
| YASARGIL PERFECT-GRIP Mikro-Nadelhalter | 362 |
| YASARGIL Raspatorien | 694-695 |
| YASARGIL Saugrohre | 324 |
| YASARGIL Scharfer Löffel | 695 |
| YASARGIL Tumor- und Gewebefaßpinzetten | 126 |
| YEOMAN Mastdarm-Biopsiezangen | 412 |
| YOUNG-HRYNTSCHAK Bumerang-Nadelhalter | 372 |
| YOUNG-MILLIN Bumerang-Nadelhalter | 372 |
| YOUNG Bulbus-Haken | 422 |
| YOUNG Prostatahaken | 422 |
| YOUNG Zungenzange | 23 |
| YOUNGE-KEVOURKIAN Endocervix-Biopsieküretten | 459 |
| YOUNGE-KEVOURKIAN Uterus-Biopsiezange | 463, 465 |

Z

| | |
|---|---------------|
| Zahnfleischscheren | 94 |
| Zahnfleischscheren DURACUT | 55 |
| Zahnprothesenschale | 751 |
| Zangen, Abfall- | 735 |
| Zangen, Abortus- | 482-483 |
| Zangen, Anlege- | 155, 158, 160 |
| Zangen, ATRAUMATIC-GRIP, Darmfaß- | 389 |
| Zangen, ATRAUMATIC-GRIP, Gewebefaß- | 389 |
| Zangen, Darmfaß- | 383-388 |
| Zangen, Drahtbiege- | 666 |
| Zangen, Drahtfaß- | 663-664 |
| Zangen, Drahtkneif- | 666 |
| Zangen, DURACUT, Drahtkneif- | 667 |
| Zangen, Entfernung- | 160 |
| Zangen, Fadenführungs- | 423 |
| Zangen, Faß- | 423 |
| Zangen, für Bulldogklemmen, Anlege- | 527 |
| Zangen, für Bulldogklemmen, Entfernung- | 527 |
| Zangen, für Klammern, Abnehm- | 691 |
| Zangen, für Klammern, Anlege- | 690-691 |
| Zangen, für Wundklammern, Entfernung- | 379 |
| Zangen, Gallenstein- | 418-419 |
| Zangen, Gewebefaß- | 383-388 |
| Zangen, Gipsabreiß- | 682 |
| Zangen, Haken- | 452-456 |
| Zangen, Hohlmeißel- | 494, 631-636 |
| Zangen, Hypophysen- | 719 |
| Zangen, IUP (Intrauterinpressar) Faß- | 447 |
| Zangen, Kappen- | 735 |
| Zangen, Kapsel-faß- | 423 |
| Zangen, Klammeranlege- | 379 |
| Zangen, Klemmenschieß- | 402 |
| Zangen, Knochenfaß- | 493 |
| Zangen, Knochenhalte- | 624-629 |
| Zangen, Knochensplitter- | 494, 637-639 |
| Zangen, Knorpelfaß- | 640 |
| Zangen, Kopfschwarten- | 481 |
| Zangen, Korn- | 204-207 |
| Zangen, Laminektomie- | 713-719 |
| Zangen, Meniskusfaß- | 640 |
| Zangen, Nagel- | 17 |
| Zangen, Nagelauseiß- | 645 |
| Zangen, Nagelhaut- | 17 |
| Zangen, Nagelspalt- | 17, 645 |
| Zangen, Nierenstein- | 420-421 |
| Zangen, Ovarien- | 457 |
| Zangen, Patella- | 623 |
| Zangen, Plazentare- | 482-483 |
| Zangen, Polypen- | 457 |

| | |
|---|------------------|
| Zangen, Repositions- | 622-623 |
| Zangen, Rippenfaß- | 493 |
| Zangen, Rundmeißel- | 494 |
| Zangen, Schädelstanz- | 688 |
| Zangen, Schneide- | 666 |
| Zangen, Schwamm- | 209-210 |
| Zangen, Sehnendurchzieh- | 649 |
| Zangen, Sehnenfaß- | 647 |
| Zangen, Sehnenführungs- | 648 |
| Zangen, Sequester- | 623 |
| Zangen, Splitter- | 151 |
| Zangen, Sterilisier- | 734 |
| Zangen, Tampon- | 208 |
| Zangen, TITE GRIP, Darmfaß- | 388 |
| Zangen, TITE GRIP, Drahtfaß- | 663 |
| Zangen, TITE GRIP, Drahtspann- | 662 |
| Zangen, TITE GRIP, Gewebefaß- | 388 |
| Zangen, TITE GRIP, Splitter- | 151 |
| Zangen, Tupfer- | 204-207, 209-210 |
| Zangen, Uterus-Biopsie- | 460-465 |
| Zangen, Uterusfaß- | 458 |
| Zangen, Uterusklemm- | 481 |
| Zangen, Zungen- | 23 |
| ZAUFAL-JANSEN Hohlmeißelzangen | 633 |
| ZENKER Präparier- und Ligaturklemmen | 188 |
| ZENKER Wundhaken | 259 |
| ZIEGLER Reflexspiegel | 10 |
| ZIEGLER Stirnband | 10 |
| ZIEGLER Stirnspiegel | 10 |
| ZIELKE Hohlmeißel mit Ferrozellgriff | 614 |
| Zirkel | 7 |
| ZOELLNER Mikro-Absaugrohr | 321 |
| Zubehör für LEYLA Retraktoren | 703, 705 |
| Zughebel für Geburtszangen | 479 |
| Zungenspatel | 12 |
| Zungenzangen | 23 |
| ZWEIFEL TITE GRIP Nadelhalter | 349 |
| Zwischenknochenmesser | 39 |
| Zylinder für Spritzen | 330-331 |

A

- Abdominal Retractors 248-249, 297-309
 Abdominal Scissors 106
 Abdominal Spatulas 266-267
ABRAMS Pleura Puncture Needle 329, 518
 Accessory Lenses 9
ADAIR-ALLIS Intestinal and Tissue Grasping Forceps 384
ADAIR Uterine Tenaculum Forceps 452
ADAMS-MAYO Appendectomy Retractors 284
ADLERKREUTZ Vascular and Tumor Forceps 148
 Adnex Scissors, DURACUT 54
ADSON-ANDERSON Self-Retaining Retractor 276
ADSON-BABY Dissecting and Ligature Forceps 180
ADSON-BECKMANN Laminectomy Retractors 279
ADSON-BROWN Delicate Tissue Forceps 141
ADSON-BROWN TITE GRIP Tissue Forceps 117
ADSON-MICRO Delicate Dissecting Forceps 129
ADSON-MICRO Delicate Tissue Forceps 140-141
ADSON-MICRO TITE GRIP Tissue Forceps 117
ADSON-TOENNIS Dissecting Scissors 89
ADSON-TOENNIS DURACUT Dissecting Scissors 49
ADSON Delicate Dissecting Forceps 129
ADSON Delicate Haemostatic Forceps 169
ADSON Delicate Tissue Forceps 140-141
ADSON Drill Guide and Dura Protecting Forceps 650
ADSON Hemi-Laminectomy Retractors 277
ADSON Laminectomy Retractors 276, 280
ADSON Needle Holders 367
ADSON Nerve and Vessel Hooks 215
ADSON Raspatories 586
ADSON Self-Retaining Retractors 273, 276-278
ADSON Suction Cannulae 323
ADSON TITE GRIP Dissecting Forceps 113
ADSON TITE GRIP Tissue Forceps 117
ADSON Twist Drill 652
 Aesthesiometer 4
ALAN-PARK Rectal Retractor 408
ALDERDYCE Dissector 574
ALDINGER-HOHMANN Bone Lever 580
ALEXANDER-FARABEUF Rib Raspatories 497
ALEXANDER Cervical Biopsy and Specimen Forceps 463
ALEXANDER Chisels 609
ALEXANDER Gouges 609
ALEXANDER Osteotomes 609
 Algesimeters 4
ALLEN Intestinal Clamp Forceps 390
ALLIS-ADAIR Intestinal and Tissue Grasping Forceps 384
ALLIS-BABY Intestinal and Tissue Grasping Forceps 383
ALLIS-BOYS Intestinal and Tissue Grasping Forceps 384
ALLIS-JUDD Intestinal and Tissue Grasping Forceps 384
ALLIS-OCHSNER Intestinal and Tissue Grasping Forceps 383
ALLIS-THOMS Intestinal and Tissue Grasping Forceps 385
ALLIS ATRAUMATIC-GRIP Intestinal and Tissue Grasping Forceps 389
ALLIS Intestinal and Tissue Grasping Forceps 383-385
ALLISON Lung Spatula 260
ALM Self-Retaining Retractors 270
ALY Algesimeter 4
AMANN Uterine Gauze Packer 447
 Amnioscopic Tubes 472
 Amniocopy and Micro-Bloodletting Instruments 472-473
 Amniotome 477
 Amputation and Resection Saws 572-573
 Amputation Knives 38-39
 Amputation Retractors 571
 Anastomosis (Vena Cava) Clamps 565
 Anastomosis and Intestinal Clamp Forceps 402
 Anastomosis Clamps, ATRAUMATIC-GRIP 520-523, 542-544, 559-560
 Anastomosis Clamps, Colon 402
 Anastomosis Sigmoid Forceps 400
ANDERSON-ADSON Self-Retaining Retractor 276
ANDREW-PYNCHON Suction Tube 325
 Anoscopes 407
 Antrum Trocar Needles 319
 Antrum Trocars 319-320
 Antrum Wash Cannulae 322
 Aorta-Anastomosis Clamps, ATRAUMATIC-GRIP 548-549
 Aorta-Aneurysma Clamps, ATRAUMATIC-GRIP 545-547
 Aortic Aneurysma Clamp, ATRAUMATIC-GRIP 561
 Aortic Clamps, ATRAUMATIC-GRIP 537-540, 561
 Aortic Dilators 511
 Apparatus and Pencils for Marking and Writing 757
 Appendectomy Clamp 403
 Appendectomy Retractors 284
 Applicators, Cotton 316-317
 Applying and Removing Forceps for Bulldog Clamps 160, 527
 Applying and Removing Forceps for Scalp Hemostasis Clips 691
 Applying Forceps for Approximators 158
 Applying Forceps for Vessel Clips 154-156
 Approximation Forceps 378
 Approximators 157-159
ARMY-US (PARKER-LANGENBECK) Retractors 231
ARMYTAGE-GREEN Caesarean Section Haemostatic Forceps 481
 Arteriotomy Scissors 95
ARTHUR Splinter Forceps 151
 Aspirating and Specimen Curettes 471
 Aspirating Curettes 471
 ATRAUMATIC-GRIP Anastomosis Clamps 520-523, 542-544, 559-560
 ATRAUMATIC-GRIP Aorta-Anastomosis Clamps 548-549
 ATRAUMATIC-GRIP Aorta-Aneurysma Clamps 545-547
 ATRAUMATIC-GRIP Aortic Aneurysma Clamp 561
 ATRAUMATIC-GRIP Aortic Clamps 537-540, 561
 ATRAUMATIC-GRIP Blood Vessel Clamps 556
 ATRAUMATIC-GRIP Bronchus Clamps 552
 ATRAUMATIC-GRIP Bulldog Clamps 525-528, 556
 ATRAUMATIC-GRIP Carotid Clamps 524, 527, 537
 ATRAUMATIC-GRIP Coarctation Clamps 532-533, 557
 ATRAUMATIC-GRIP Delicate Haemostatic Forceps 165, 167
 ATRAUMATIC-GRIP Dissecting and Ligature Forceps 551
 ATRAUMATIC-GRIP Hysterectomy Forceps 197
 ATRAUMATIC-GRIP Iliac Clamps 558
 ATRAUMATIC-GRIP Intestinal and Tissue Grasping Forceps 389
 ATRAUMATIC-GRIP Intestinal Clamp Forceps 391-393, 395-396
 ATRAUMATIC-GRIP Kidney Clamps 190
 ATRAUMATIC-GRIP Ligature and Dissecting Forceps 551
 ATRAUMATIC-GRIP Lower Occlusive Clamps 399
 ATRAUMATIC-GRIP Multi-Purpose Clamps 520-523, 530, 553-554, 556, 562
 ATRAUMATIC-GRIP Patent Ductus Clamps 531, 556
 ATRAUMATIC-GRIP Peripheral Vascular Clamps 534-536, 558
 ATRAUMATIC-GRIP Renal Artery Clamp 537, 558
 ATRAUMATIC-GRIP Sigmoid Anastomosis Forceps 400-401
 ATRAUMATIC-GRIP Stomach Clamp Forceps 397
 ATRAUMATIC-GRIP Tangential Occlusion Clamps 541, 562
 ATRAUMATIC-GRIP Upper Occlusive Clamp 398
 ATRAUMATIC-GRIP Vascular Clamps 520-523, 529-530, 534, 537, 555, 558, 561-562
 ATRAUMATIC-GRIP Vascular Forceps 135
 ATRAUMATIC-GRIP Vena-Cava Clamps 550
 ATRAUMATIC GRIP Dissecting and Ligature Forceps 186
 ATRAUMATIC GRIP Haemostatic Forceps 176
 ATRAUMATIC GRIP Profunda Clamps 534
 Atrium Retractors 509
AUFRICHT Plastic Surgery Scissors 82
AUFRICHT Rasps 593
 Auricle Clamps 564
AUSTIN Micro Suture Tying Forceps 122
 Autopsy Knife 40
AUVARD-BERLIND Vaginal Speculum 441
AUVARD Vaginal Specula 441

B

- BABCOCK** ATRAUMATIC-GRIP Intestinal and Tissue Grasping Forceps 389
BABCOCK Intestinal and Tissue Grasping Forceps 385
BABCOCK TITE GRIP Intestinal and Tissue Grasping Forceps 388
BABY-ADSON Dissecting and Ligature Forceps 180
BABY-ALLIS Intestinal and Tissue Grasping Forceps 383
BABY-BAILEY Rib Contractor 508
BABY-BALFOUR Abdominal Retractor 300
BABY-COLLIN Abdominal Retractor 297
BABY-CRILE Delicate Haemostatic Forceps 166
BABY-DOYEN ATRAUMATIC-GRIP Intestinal Clamp Forceps 391
BABY-DOYEN Intestinal Clamp Forceps 391
BABY-FINOCHIETTO-HAIGHT Rib Spreaders from ALUMINIUM 501
BABY-FINOCHIETTO Rib Spreaders 503

| | | | |
|--|---------|---|--------------|
| BABY-GELPI Vaginal Retractor | 281 | BERLIND-AUVARD Vaginal Speculum | 441 |
| BABY-GILLIES Needle Holders with Scissors | 370 | BERLINER Percussion Hammer | 2 |
| BABY-GILLIES TITE GRIP Needle Holder | 348 | BERNHARD Towel Clamps | 201 |
| BABY-GOSSET Abdominal Retractor | 299 | BETHUNE Rib Shears | 493 |
| BABY-KELLY Delicate Haemostatic Forceps | 168 | BEYER Bone Rongeurs | 632-633 |
| BABY-KOCHER ATRAUMATIC-GRIP Intestinal Clamp Forceps | 391 | BEYER Laminectomy Punch | 707 |
| BABY-KOCHER Intestinal Clamp Forceps | 391 | BIEMER-MÜLLER Approximators | 157 |
| BABY-LEXER Dissecting Scissors | 87 | BIEMER Vein Scissors | 63 |
| BABY-MEEKER Dissecting and Ligature Forceps | 180 | BIEMER Vessel Clips | 156 |
| BABY-METZENBAUM Dissecting Scissors | 89 | BIER Amputation and Resection Saw | 573 |
| BABY-MIKULICZ Peritoneum Forceps | 192 | Bile Duct Dilators, Common | 416 |
| BABY-MIXTER Dissecting and Ligature Forceps | 180 | BILL Traction Handle for Forceps | 479 |
| BABY-MOSQUITO (HARTMANN) Delicate Haemostatic Forceps | 164 | Binocular Head Magnifiers | 8-9 |
| BABY-OLSEN-HEGAR TITE GRIP Needle Holder | 348 | Binocular Magnifying Spectacles | 9 |
| BABY-OVERHOLT Dissecting and Ligature Forceps | 183 | Biopsy Curettes | 459-460 |
| BABY-PAYR Intestinal and Stomach Clamp | 403 | Biopsy Instruments, Bone | 669 |
| BABY-ROUX Retractors | 228 | Biopsy Instruments, Vertebral | 720-721 |
| BABY-SATINSKY Anastomosis (Vena Cava) Clamp | 565 | Biopsy Needles | 329, 518 |
| BABY-TISCHLER Cervical Biopsy and Specimen Forceps | 464 | Biopsy Specimen Forceps, Rectal | 412 |
| BACKHAUS Towel Clamps | 201 | BIRCHER-GANSKE Meniscus and Cartilage Grasping Forceps | 640 |
| BADGLEY Self-Retaining Retractors | 286 | BIRCHER Meniscus Knives | 643 |
| BAHNSON-DE BAKEY ATRAUMATIC-GRIP Aorta-Aneurysma Clamps | 545 | Bladder and Wound Syringes | 331 |
| BAILEY-BABY Rib Contractor | 508 | Bladder Neck Spreader | 423 |
| BAILEY-GIBBON Rib Contractor | 508 | Bladder Retractors | 310 |
| BAILEY (DE MARTEL) Conductor for Wire Saws | 687 | Bladder Spatulas | 268 |
| BAILEY ATRAUMATIC-GRIP Aortic Clamps | 538 | Blades | 36 |
| BAILEY Rib Contractor | 508 | Blades, Micro for Bloodletting | 473 |
| BAINBRIDGE-DE BAKEY ATRAUMATIC-GRIP Vascular Clamps | 530 | BLAKE-MAYO Gall Stone Forceps | 418 |
| BAINBRIDGE Intestinal Clamp Forceps | 390 | BLAKE Gall Stone Forceps | 418 |
| BAKES Common Bile Duct Dilators | 416 | BLAKE Uterine Curette | 466 |
| BALFOUR-BABY Abdominal Retractor | 300 | BLAKESLEY-WEIL Laminectomy Rongeurs | 714 |
| BALFOUR-KIRSCHNER Valve for Abdominal Retractors | 307 | BLESSING DURACUT Scissors for Rectal Surgery | 59 |
| BALFOUR Abdominal Retractors | 300-301 | Blood Vessel Clamps, ATRAUMATIC-GRIP | 556 |
| BALFOUR Central Valves for Abdominal Retractors | 303 | BLOUNT Hib Levers | 580 |
| BALFOUR Lateral Valves for Abdominal Retractors | 303 | BLOUNT Retractors for Knee | 641 |
| BALFOUR modif. Abdominal Retractors | 302 | BLUMENTHAL Bone Rongeurs | 631 |
| BALFOUR Side-Arms for Abdominal Retractors | 303 | BLUNT Safety Pin | 736 |
| BALLENGER-FOERSTER Dressing and Sponge Holding Forceps | 209 | BOETTCHER Tonsil Scissors | 103 |
| BALLENTINE-HEANEY Hysterectomy Forceps | 196 | BÖHLER (WALTON-LISTON) Bone Cutting Forceps | 638 |
| BALLENTINE Hysterectomy Forceps | 196 | BÖHLER Bone Rongeurs | 633 |
| Bandage and Cloth Scissors | 674 | BÖHLER Wire Traction Bows | 654 |
| Bandage Compressions | 570 | Bone Biopsy Instruments | 669 |
| Bandage Scissors | 672-674 | Bone Biopsy Trephines | 669 |
| Bandage Scissors, DURACUT | 673 | Bone Clamps | 630 |
| BARNES Suction Cannula | 321 | Bone Curettes | 598-606 |
| BARR Rectal Retractor | 408 | Bone Cutting Forceps | 494, 637-639 |
| BARRAQUER-TROUTMAN Micro Needle Holders | 360 | Bone Files | 592, 594-595 |
| BARRAQUER Cilia Forceps | 152 | Bone Holding and Rib Forceps | 493 |
| BARRAQUER Micro Needle Holders | 360 | Bone Holding Forceps | 624-629 |
| BARRAYA-STILLE Vascular and Tumor Forceps | 148 | Bone Levers | 576-581 |
| Barrels | 330-331 | Bone Retractors | 232 |
| BARRETT Uterine Tenaculum Forceps | 452 | Bone Rongeurs | 631-636 |
| BARTH Bone Curette | 599 | Bone Wires | 660 |
| Basins, Triangular | 750 | BONN MOD. Delicate Tissue Forceps | 138 |
| Baskets, Brush and Towel | 753 | BONNEY Dissecting Forceps | 134 |
| Baskets, Sterilizing | 745 | BONNEY Tissue Forceps | 147 |
| Baskets, Towel and Brush | 753 | BONNEY TITE GRIP Dissecting Forceps | 115 |
| BAUMGARTNER-HEGAR TITE GRIP Needle Holder | 342 | BONNEY TITE GRIP Tissue Forceps | 118 |
| BAUMGARTNER Needle Holders | 366 | Boomerang Needle Holders | 372 |
| BAUMGARTNER TITE GRIP Needle Holder | 342 | BOSE Trachea Retractors | 728 |
| BEACHAM Amniotome | 477 | Bougies, Dilating | 424 |
| BECK-COOLEY ATRAUMATIC-GRIP Anastomosis Clamps | 560 | Bowl for Dentures | 751 |
| BECK-DE BAKEY ATRAUMATIC-GRIP Anastomosis Clamps | 543 | Bowls, Kidney | 750 |
| BECK-DE BAKEY ATRAUMATIC-GRIP Aortic Clamps | 537 | Bowls, Solution | 749 |
| BECK-DE BAKEY ATRAUMATIC-GRIP Vena-Cava Clamps | 550 | Bowls, Wash | 749 |
| BECKMANN-ADSON Laminectomy Retractors | 279 | Boxes, Instrument | 746 |
| BECKMANN-EATON Laminectomy Retractors | 280 | Boxes, Sterilizing | 739-742 |
| BECKMANN Laminectomy Retractors | 280 | BOYS-ALLIS Intestinal and Tissue Grasping Forceps | 384 |
| Bed Pan | 750 | BOZEMANN-DOUGLAS Uterine Dressing Forceps | 208 |
| BEEBEE Wire Cutting Scissors | 665 | BOZEMANN (WERTHEIM) TITE GRIP Needle Holders | 346 |
| BEER Cilia Forceps | 152 | BOZEMANN Uterine Dressing Forceps | 208 |
| BELMONT-RUMEL Tourniquets | 518 | Brain Clips | 690 |
| BENGOLEA Delicate Haemostatic Forceps | 172 | Brain Knives | 40 |
| BENNETT Bone Levers | 581 | Brain Retractors, Self-Retaining | 702-705 |
| BENSON Pylorus Spreader | 403 | Brain Spatulas | 706 |
| BERGER Binocular Head Magnifiers | 8 | BRAND Tendon Holding Forceps | 648 |
| BERGER Cervical Biopsy and Specimen Forceps | 462 | BRAUN-SIMPSON Forceps | 478 |
| BERGMANN Cloth Scissors and Plaster-of-Paris Shears | 675 | BRAUN-STADLER Perineum (Episiotomy) Scissors | 107 |
| BERGMANN Mallets | 621 | BRAUN Cranioclast | 485 |

| | |
|--|--------------|
| BRAUN Decapitating Hook | 485 |
| BRAUN Uterine Depressor | 447 |
| BRAUN Uterine Tenaculum Forceps | 452, 454 |
| BRAWLEY Rasp | 593 |
| Breakers, Plaster | 682 |
| BREISKY Vaginal Specula | 438, 440 |
| BRIDGE Dissecting and Ligature Forceps | 187 |
| BRINKERHOFF Rectal Specula | 406 |
| Bronchus Clamps, ATRAUMATIC-GRIP | 552 |
| Bronchus Forceps | 566 |
| BROPHY (SULLIVAN) Delicate Dissecting Scissors | 93 |
| BROPHY Delicate Dissecting Forceps | 131 |
| BROPHY Delicate Tissue Forceps | 143 |
| BROWN-ADSON Delicate Tissue Forceps | 141 |
| BROWN-ADSON TITE GRIP Tissue Forceps | 117 |
| BROWN Needle Holders | 366 |
| BROWN Tissue Seizing Forceps | 148 |
| BROWNE-DENIS Abdominal Retractor | 305 |
| BRUENINGS Tongue Depressor | 12 |
| BRUNNER Retractors for Deep Surgery | 252-253 |
| BRUNNER Sigmoid Anastomosis Forceps | 400 |
| BRUNS Plaster-of-Paris Shears | 676 |
| BRUNS Bone Curettes | 602-603 |
| BRUNS DURACUT Plaster-of-Paris Shears | 676 |
| Brush and Towel Baskets | 753 |
| Brush Dispensers | 752 |
| Brushes, Cleaning | 756 |
| Brushes, Cleaning for Trachea Tubes | 727 |
| Brushes, Nail | 752 |
| BUCHWALD Tongue Depressor | 12 |
| BUCK-GRAMCKO Bone Lever | 576 |
| BUCK Percussion Hammer | 3 |
| BUELAU Empyema Trocar | 318 |
| BUIE-SMITH Rectal Retractor | 408 |
| BUIE Pressure Clamp | 409 |
| Bulbus Hooks | 422 |
| Bulldog Clamps | 163 |
| Bulldog Clamps, ATRAUMATIC-GRIP | 525-528, 556 |
| Bulldog Clamps, Micro | 162 |
| Bulldog Clamps, TITAN LINE | 160-161 |
| BUMM Placenta and Ovum Curettes | 484 |
| BUMM Uterine Curettes | 470 |
| BUNNELL Hand Drill | 653 |
| BUNNELL Tendon Passing Instrument | 646 |
| BUNNELL Tendon Strippers | 646 |
| BURFORD-FINOCCHIETTO Rib Spreaders | 503 |
| BURFORD-FINOCCHIETTO Rib Spreaders from ALUMINIUM | 502 |
| BURKE Cervical Biopsy and Specimen Forceps | 464 |
| Burrs | 652 |
| BUSH Umbilical Cord Scissors | 108 |
| Buttoned Probes | 312-313, 694 |

C

| | |
|--|---------------|
| Caesarean Section Haemostatic Forceps | 481 |
| Calipers | 7 |
| CALNE ATRAUMATIC-GRIP Vena-Cava Clamps | 550 |
| CANAD. MODELL Meniscus Knives | 643 |
| CANNON Endarterectomy Set | 515 |
| CANNON Endarterectomy Stripper | 514 |
| CANNON Intima Knife | 513 |
| CANNON Intima Spatula | 513 |
| Cannulae, Antrum Wash | 322 |
| Cannulae, Suction | 320-323 |
| Cannulae, Trocar | 721 |
| Cannulae, Vascular Irrigation | 322 |
| CAPLAN DURACUT Septum Scissors | 59 |
| Capsule Forceps | 423 |
| CARMALT-ROCHESTER Haemostatic Forceps | 178 |
| Carotid Clamps, ATRAUMATIC-GRIP | 524, 527, 537 |
| CAROTIS-DE BAKEY ATRAUMATIC-GRIP Bulldog Clamps | 525 |
| Carpal Tunnel and Hand Retractor | 271 |
| Carrier for Clips | 690-691 |
| Carrier for Micro Blades | 473 |
| CARROLL Needle Holders | 366 |
| CARROLL Tendon Holding Forceps | 648 |
| CARROLL TITE GRIP Needle Holder | 344 |
| Cartilage Grasping and Meniscus Forceps | 640 |

| | |
|---|---|
| Cartilage Scissors | 82 |
| Cases, Sterilizing and Storing | 738 |
| CASPAR Exploration and Coagulation Hooks | 215 |
| CASPAR Laminectomy Rongeurs | 718-719 |
| CASPAR Raspatories | 585 |
| CASPAR Retractor | 245 |
| CASPAR Self-Retaining Retractors | 288-294 |
| CASPAR Specula for Lumbar Vertebral Operations | 295 |
| CASTANEDA ATRAUMATIC-GRIP Anastomosis Clamps | 520 |
| CASTANEDA ATRAUMATIC-GRIP Multi-Purpose Clamps | 520 |
| CASTANEDA Rib Spreaders from ALUMINIUM | 500 |
| CASTROVIEJO-MICRO Micro Needle Holders | 358 |
| CASTROVIEJO Calipers | 7 |
| CASTROVIEJO Delicate Tissue Forceps | 138 |
| CASTROVIEJO Needle Holder | 363 |
| CASTROVIEJO Razor Blade Holders and Breakers | 36 |
| CASTROVIEJO TITE GRIP Micro Needle Holders | 338-339 |
| Catgut | 353 |
| Catheter Introducing Forceps | 32 |
| Catheter Introducing Instrument | 425 |
| Catheters, Eustachian | 322 |
| Catheters, Metal | 424 |
| Catheter Guides | 425 |
| CATLIN Amputation Knives | 38 |
| Cerclage Instruments | 660 |
| Cervical Biopsy and Specimen Forceps | 460-465 |
| Cervical Spine Retractors | 285 |
| Cervical Traction Tongs | 689 |
| Cervical Vertebral Column Retractors | 290-292 |
| CHAMPY Bone Biopsy Trephines | 669 |
| CHAPUT Intestinal and Tissue Grasping Forceps | 383 |
| CHARRIÈRE Amputation and Resection Saw | 572-573 |
| CHEATTLE Sterilizing Forceps | 734 |
| CHERON Sponge and Dressing Forceps | 207 |
| CHEVALIER-JACKSON Trachea Tubes | 726 |
| CHEVALIER Rib Spreaders | 507 |
| CHEYNE-WATSON Dissector | 574 |
| CHILDE Approximation Forceps | 378 |
| Chisel Blades, Interchangeable | 611 |
| Chisels | 607, 609-611 |
| Chisels, Sternum | 492 |
| Cilia Forceps | 152 |
| Circumcision Clamp | 426 |
| Circumcision Instruments | 426 |
| CITELLI Laminectomy Punches | 707 |
| Clamp Closing Forceps | 402 |
| Clamp Holders | 402 |
| Clamps, Anastomosis (Vena Cava) | 565 |
| Clamps, Appendectomy | 403 |
| Clamps, ATRAUMATIC-GRIP, Anastomosis | 520-523, 542-544, 559-560 |
| Clamps, ATRAUMATIC-GRIP, Aorta-Anastomosis | 548-549 |
| Clamps, ATRAUMATIC-GRIP, Aorta-Aneurysma | 545-547 |
| Clamps, ATRAUMATIC-GRIP, Aortic | 537-540, 561 |
| Clamps, ATRAUMATIC-GRIP, Aortic Aneurysma | 561 |
| Clamps, ATRAUMATIC-GRIP, Blood Vessel | 556 |
| Clamps, ATRAUMATIC-GRIP, Bronchus | 552 |
| Clamps, ATRAUMATIC-GRIP, Bulldog | 525-528, 556 |
| Clamps, ATRAUMATIC-GRIP, Carotid | 524, 527, 537 |
| Clamps, ATRAUMATIC-GRIP, Coarctation | 532-533, 557 |
| Clamps, ATRAUMATIC-GRIP, Iliac | 558 |
| Clamps, ATRAUMATIC-GRIP, Kidney | 190 |
| Clamps, ATRAUMATIC-GRIP, Lower Occlusive | 399 |
| Clamps, ATRAUMATIC-GRIP, Multi-Purpose Clamps | 520-523, 530, 553-554, 556, 562 |
| Clamps, ATRAUMATIC-GRIP, Patent Ductus | 531, 556 |
| Clamps, ATRAUMATIC-GRIP, Peripheral Vascular | 534-536, 558 |
| Clamps, ATRAUMATIC-GRIP, Profunda | 534 |
| Clamps, ATRAUMATIC-GRIP, Renal Artery | 537, 558 |
| Clamps, ATRAUMATIC-GRIP, Tangential Occlusion | 541, 562 |
| Clamps, ATRAUMATIC-GRIP, Upper Occlusive | 398 |
| Clamps, ATRAUMATIC-GRIP, Vascular | 520-523, 529-530, 534, 537, 555, 558, 561-562 |
| Clamps, ATRAUMATIC-GRIP, Vena Cava | 550 |
| Clamps, Auricle | 564 |
| Clamps, Bone | 630 |
| Clamps, Bulldog | 163 |
| Clamps, Circumcision | 426 |
| Clamps, Colon-Anastomosis | 402 |
| Clamps, Fixation for the Spermatic Cord | 425 |

| | |
|--|--------------|
| Clamps, Intestinal and Stomach | 403 |
| Clamps, Kidney | 190 |
| Clamps, Kidney Pedicle | 191 |
| Clamps, Micro Bulldog | 162 |
| Clamps, Muscular | 728 |
| Clamps, Penis | 426 |
| Clamps, Pressure | 409 |
| Clamps, Stomach and Intestinal | 403 |
| Clamps, TITAN LINE, Bulldog | 160-161 |
| Clamps, Towel | 200-202 |
| Clamps, Tubing | 203 |
| Clamps, Umbilical Cord | 486 |
| Clamps, Vascular, Semi-Flexible | 563 |
| Clamps, Vena Cava (Anastomosis) | 565 |
| CLAR Head Light | 11 |
| Cleaning Brush for Trachea Tubes | 727 |
| Cleaning Brushes | 756 |
| CLEVELAND Bone Cutting Forceps | 637 |
| Clip Applying and Removing Forceps | 379 |
| Clip Applying Forceps | 690 |
| Clip Carrier | 690-691 |
| Clip Instruments | 690-691 |
| Clips, Brain | 690 |
| Clips, Scalp Hemostasis | 691 |
| Clips, Suture | 379 |
| Clips, Suture | 404 |
| Cloth and Bandage Scissors | 674 |
| Cloth Scissors | 674-675 |
| CLOWARD Lamina Spreaders | 296 |
| CLOWARD Retractors for Cervical Spine | 285 |
| Coagulation and Exploration Hooks | 215 |
| COAKLEY Antrum Trocar | 319 |
| Coarctation Clamps, ATRAUMATIC-GRIP | 532-533, 557 |
| COBB Raspatories | 589, 591 |
| COBB Spinal Gouges | 616 |
| COLCLOUGH (KERRISON-LOVE) Laminectomy Punches | 710-711 |
| Cold-Light Proximal Illumination for Amnioscopic Tubes | 472 |
| COLLER-CRILE Delicate Haemostatic Forceps | 167 |
| COLLIER Needle Holder | 363 |
| COLLIN-BABY Abdominal Retractor | 297 |
| COLLIN-DUVAL Intestinal and Tissue Grasping Forceps | 386 |
| COLLIN-DUVAL Intestinal Forceps | 149 |
| COLLIN-FARABEUF Raspatories | 588 |
| COLLIN-HARTMANN Retractor | 229 |
| COLLIN-LANDAU Vaginal Specula | 431 |
| COLLIN Abdominal Retractors | 297-298 |
| COLLIN ATRAUMATIC-GRIP Intestinal and Tissue Grasping Forceps | 389 |
| COLLIN Clip Removing Forceps | 379 |
| COLLIN Dynamometer | 6 |
| COLLIN Intestinal and Tissue Grasping Forceps | 386 |
| COLLIN Mallet | 617 |
| COLLIN Retractors | 227 |
| COLLIN Sponge and Dressing Forceps | 207 |
| COLLIN Tongue Holding Forceps | 23 |
| COLLIN Umbilical Cord Clamp | 486 |
| COLLIN Uterine Elevating Forceps | 458 |
| COLLIN Vaginal Specula | 431 |
| Colon-Anastomosis Clamps | 402 |
| Comedo Extractors | 19 |
| Common Bile Duct Dilators | 416 |
| Compression Bandage | 570 |
| Compression Tube | 570 |
| Comprimeter | 570 |
| Conductors, Ligature | 377-378 |
| Conductors, Wire Saws | 687 |
| CONE Cranial Punch Rongeur | 688 |
| Conisation Pin | 447 |
| Connecting Pieces for Syringes | 333 |
| Containers | 747 |
| CONTOUR SCALP Self-Retaining Retractors | 276 |
| Contractors, Rib | 508 |
| CONVERSE (GILLIES) Dura and Skin Retractors | 216 |
| CONVERSE TITE GRIP Needle Holder | 342 |
| COOLEY-BECK ATRAUMATIC-GRIP Anastomosis Clamps | 560 |
| COOLEY-DERRA ATRAUMATIC-GRIP Anastomosis Clamps | 559 |
| COOLEY-REYNOLDS ATRAUMATIC-GRIP Anastomosis Clamps | 559 |
| COOLEY Aortic Dilator | 511 |
| COOLEY ATRAUMATIC-GRIP Anastomosis Clamps | 560 |
| COOLEY ATRAUMATIC-GRIP Aortic Aneurysma Clamp | 561 |
| COOLEY ATRAUMATIC-GRIP Aortic Clamp | 561 |
| COOLEY ATRAUMATIC-GRIP Bulldog Clamps | 556 |
| COOLEY ATRAUMATIC-GRIP Coarctation Clamps | 557 |
| COOLEY ATRAUMATIC-GRIP Iliac Clamps | 558 |
| COOLEY ATRAUMATIC-GRIP Multi-Purpose Clamps | 556, 562 |
| COOLEY ATRAUMATIC-GRIP Patent Ductus Clamps | 556 |
| COOLEY ATRAUMATIC-GRIP Peripheral Vascular Clamp | 558 |
| COOLEY ATRAUMATIC-GRIP Renal Artery Clamps | 558 |
| COOLEY ATRAUMATIC-GRIP Tangential Occlusion Clamps | 562 |
| COOLEY ATRAUMATIC-GRIP Vascular Clamps | 555 |
| COOLEY Atrium Retractors | 509 |
| COOLEY Intracardiac Suction Tube | 327 |
| COOLEY Left Ventricular Sump Suction Tube | 327 |
| COOLEY Sternotomy Spreaders | 499 |
| COOLEY Sternotomy Spreaders from ALUMINIUM | 498 |
| COOLEY Suction Tubes | 327 |
| COOLEY Vascular Dilators | 510 |
| COOLEY Vascular Suction Tube | 327 |
| COOPER Ligature Needle | 374 |
| Coronary Artery Scissors | 95 |
| CORWIN-HEGAR TITE GRIP Wire Twisting Forceps | 662 |
| CORYLLOS Retractors and Lung Spatulas | 261 |
| COTTLE-NEIVERT Hook for Posterior Nares | 221 |
| COTTLE Dura and Skin Retractor | 217 |
| COTTLE DURACUT Nasal Scissors | 58 |
| COTTLE Hook for Plastic Surgery | 218 |
| COTTLE Mallet | 620 |
| COTTLE Nasal Scissors | 102 |
| COTTLE Osteotomes | 608 |
| COTTLE Rasp | 593 |
| COTTLE Raspatory | 583, 585 |
| Cotton and Sponge Holder | 473 |
| Cotton Applicators | 316-317 |
| Cotton Carrier | 409 |
| Cover Glass Forceps | 152 |
| CRAFOORD-DE BAKEY ATRAUMATIC-GRIP Aorta-Aneurysma Clamps | 546 |
| CRAFOORD-STILLE Delicate Haemostatic Forceps | 170 |
| CRAFOORD (STELZNER) Lobectomy and Rectal Scissors | 99 |
| CRAFOORD Auricle Clamps | 564 |
| CRAFOORD Delicate Haemostatic Forceps | 171 |
| CRAIG-KOGLER Vertebral Biopsy Instruments | 720-721 |
| Cranial Opening Instruments | 687 |
| Cranial Punch Rongeur | 688 |
| Cranial Rongeur | 688 |
| Cranial Rongeur Forceps | 688 |
| Cranioclast | 485 |
| CRILE-BABY Delicate Haemostatic Forceps | 166 |
| CRILE-COLLER Delicate Haemostatic Forceps | 167 |
| CRILE-MICRO Delicate Haemostatic Forceps | 166 |
| CRILE-MURRAY Needle Holders | 366 |
| CRILE-RANKIN-DE BAKEY ATRAUMATIC-GRIP Delicate Haemostatic Forceps | 167 |
| CRILE-RANKIN (OCHSNER-DIXON) Delicate Haemostatic Forceps | 167 |
| CRILE-RANKIN Delicate Haemostatic Forceps | 167 |
| CRILE-WOOD Needle Holders | 366, 368 |
| CRILE-WOOD TITE GRIP Needle Holders | 343 |
| CRILE-WOOD TITE GRIP Needle Holders for Left-Hander | 341 |
| CRILE Delicate Haemostatic Forceps | 166 |
| CRILE Needle Holders | 371 |
| CRILE Nerve and Vessel Hooks | 214 |
| CRILE Retractor | 227 |
| CRILE TITAN LINE Delicate Haemostatic Forceps | 166 |
| CRUTCHFIELD Cervical Traction Tongs | 689 |
| CRUTCHFIELD Drill Point for Cervical Traction Tongs | 689 |
| Cryothyrotomy Trocars | 728 |
| Crypt Hooks | 409 |
| CULLEN-WERTHEIM Kidney Pedicle Clamp | 191 |
| Cups, Storing | 737 |
| Curettes | 692 |
| Curettes, Aspirating | 471 |
| Curettes, Aspirating and Specimen | 471 |
| Curettes, Biopsy | 459-460 |
| Curettes, Bone | 598-606 |
| Curettes, Endocervical Biopsy | 459-460 |
| Curettes, Endometrical Biopsy | 459 |
| Curettes, Endometrical Suction Biopsy | 459 |
| Curettes, Lupus | 20 |
| Curettes, Ovum and Placenta | 484 |
| Curettes, Placenta and Ovum | 484 |

| | |
|--|---------|
| Curettes, Secretion | 425 |
| Curettes, Specimen and Aspirating | 471 |
| Curettes, Uterine | 466-470 |
| CURTIS Tissue Forceps | 147 |
| CUSCO Vaginal Specula | 430-431 |
| CUSHING-LANDOLT Specula for Trans-Sphenoidal Hypophysectomy | 692 |
| CUSHING-SMITH-FERRIS Laminectomy Rongeurs | 713 |
| CUSHING-TAYLOR Delicate Dissecting Forceps | 131 |
| CUSHING-TAYLOR Delicate Tissue Forceps | 143 |
| CUSHING-TAYLOR Ear and Nasal Dressing Forceps | 136 |
| CUSHING-TAYLOR TITE GRIP Dissecting Forceps | 114 |
| CUSHING Brain Spatulas | 706 |
| CUSHING Decompression Hook | 701 |
| CUSHING Delicate Dissecting Forceps | 130 |
| CUSHING Delicate Tissue Forceps | 142 |
| CUSHING Drills | 652 |
| CUSHING Dura Hook | 218 |
| CUSHING Laminectomy Rongeurs | 715 |
| CUSHING Nerve and Vessel Hooks | 214 |
| CUSHING TITE GRIP Dissecting Forceps | 114 |
| CUSHING Vein Retractors | 222-223 |
| Cuticle Nippers | 17 |
| Cuticle Scissors | 16 |
| Cutters | 667-668 |
| Cutters, DURACUT, Wire | 667 |
| CUZZI Placenta and Ovum Scoops | 484 |
| CZERNY Rectal Speculum | 405 |
| CZERNY Uterine Tenaculum Forceps | 455 |

D

| | |
|--|---------------|
| DAHLGREN Cranial Rongeur | 688 |
| DALE ATRAUMATIC-GRIP Peripheral Vascular Clamps | 535 |
| DANDY Delicate Haemostatic Forceps | 165 |
| DANDY Nerve and Vessel Hooks | 214 |
| DARDIK ATRAUMATIC-GRIP Multi-Purpose Clamps | 554 |
| DARTIGUES Kidney Elevating Forceps | 421 |
| DAUBENSPECK Bone Curette | 604 |
| DAVIDSON Scapula Retractors | 260 |
| DAVIS-RAGNELL Hook for Plastic Surgery | 226 |
| DAVIS Brain Spatulas | 706 |
| DAY Ear Hooklets | 213 |
| DE BAKEY-BAHNSON ATRAUMATIC-GRIP Aorta-Aneurysma Clamps | 545 |
| DE BAKEY-BAINBRIDGE ATRAUMATIC-GRIP Vascular Clamps | 530 |
| DE BAKEY-BECK ATRAUMATIC-GRIP Anastomosis Clamps | 543 |
| DE BAKEY-BECK ATRAUMATIC-GRIP Aortic Clamps | 537 |
| DE BAKEY-BECK ATRAUMATIC-GRIP Vena-Cava Clamps | 550 |
| DE BAKEY-CAROTIS ATRAUMATIC-GRIP Bulldog Clamps | 525 |
| DE BAKEY-CRAFOORD ATRAUMATIC-GRIP Aorta-Aneurysma Clamps | 546 |
| DE BAKEY-CRILE-RANKIN ATRAUMATIC-GRIP Delicate Haemostatic Forceps | 167 |
| DE BAKEY-DERRA ATRAUMATIC-GRIP Anastomosis Clamps | 542 |
| DE BAKEY-DIETRICH ATRAUMATIC-GRIP Bulldog Clamps | 526 |
| DE BAKEY-GLOVER ATRAUMATIC-GRIP Bulldog Clamps | 525 |
| DE BAKEY-GUYON ATRAUMATIC-GRIP Kidney Clamps | 190 |
| DE BAKEY-HALSTED-MOSQUITO ATRAUMATIC-GRIP Delicate Haemostatic Forceps | 165 |
| DE BAKEY-HARKEN ATRAUMATIC-GRIP Dissecting and Ligature Forceps | 551 |
| DE BAKEY-HEANY (ROGERS) Hysterectomy Forceps | 197 |
| DE BAKEY-MORRIS ATRAUMATIC-GRIP Aortic Clamps | 540 |
| DE BAKEY-PEAN ATRAUMATIC-GRIP Haemostatic Forceps | 176 |
| DE BAKEY-PEAN ATRAUMATIC-GRIP Vascular Clamps | 529 |
| DE BAKEY-POTTS ATRAUMATIC-GRIP Patent Ductus Clamps | 531 |
| DE BAKEY-REYNOLDS ATRAUMATIC-GRIP Anastomosis Clamps | 542 |
| DE BAKEY-RUMEL ATRAUMATIC-GRIP Dissecting and Ligature Forceps | 186 |
| DE BAKEY-SATINSKY ATRAUMATIC-GRIP Bulldog Clamps | 525 |
| DE BAKEY-SATINSKY ATRAUMATIC-GRIP Tangential Occlusion Clamps | 541 |
| DE BAKEY-WERTHEIM (ROGERS) Parametrium Forceps | 197 |
| DE BAKEY (GARRET) Vascular Dilators | 510 |
| DE BAKEY Arteriotomy Scissors | 95 |
| DE BAKEY ATRAUMATIC-GRIP Anastomosis Clamps | 543 |
| DE BAKEY ATRAUMATIC-GRIP Aorta-Aneurysma Clamps | 545, 547 |
| DE BAKEY ATRAUMATIC-GRIP Aortic Clamps | 539 |
| DE BAKEY ATRAUMATIC-GRIP Bulldog Clamps | 526, 528 |
| DE BAKEY ATRAUMATIC-GRIP Coarctation Clamps | 532-533 |
| DE BAKEY ATRAUMATIC-GRIP Dissecting and Ligature Forceps | 551 |
| DE BAKEY ATRAUMATIC-GRIP Multi-Purpose Clamps | 530, 553 |
| DE BAKEY ATRAUMATIC-GRIP Patent Ductus Clamps | 531 |
| DE BAKEY ATRAUMATIC-GRIP Peripheral Vascular Clamps | 534-536 |
| DE BAKEY ATRAUMATIC-GRIP Renal Artery Clamp | 537 |
| DE BAKEY ATRAUMATIC-GRIP Tangential Occlusion Clamps | 541 |
| DE BAKEY ATRAUMATIC-GRIP Vascular Clamps | 529 |
| DE BAKEY ATRAUMATIC-GRIP Vascular Forceps | 135 |
| DE BAKEY DURACUT Vascular Scissors | 57 |
| DE BAKEY Rib Spreaders | 504-505 |
| DE BAKEY Suction Tube | 325 |
| DE BAKEY TITE GRIP Needle Holders | 343 |
| DE BAKEY TITE GRIP Needlepulling Tissue Forceps | 116 |
| DE BAKEY Vascular Scissors | 96 |
| DE MARTEL-WOLFSON Clamp Closing Forceps | 402 |
| DE MARTEL-WOLFSON Clamp Holders | 402 |
| DE MARTEL-WOLFSON Colon-Anastomosis Clamps | 402 |
| DE MARTEL (BAILEY) Conductor for Wire Saws | 687 |
| DE VILBISS Cranial Rongeur | 688 |
| DE VILBISS Vaginal Specula | 433 |
| DEAN DURACUT Gum Scissors | 55 |
| DEAN Tonsil Scissors | 103 |
| DEAVER-FORD Retractors and Lung Spatulas | 263 |
| DEAVER Retractors and Lung Spatulas | 264-265 |
| DEAVER Surgical Scissors | 71 |
| Decapitating Hook | 485 |
| Decapitating Scissors | 109 |
| Decompression Hook | 701 |
| Deep Hand and Forearm Retractor | 271 |
| Delicate Dissecting Forceps | 128-131 |
| Delicate Dissecting Scissors | 92-93 |
| Delicate Haemostatic Forceps | 164-172 |
| Delicate Haemostatic Forceps, ATRAUMATIC-GRIP | 165, 167 |
| Delicate Haemostatic Forceps, TITAN LINE | 164, 166, 168 |
| Delicate Scissors, DURACUT | 45 |
| Delicate Surgical Scissors | 68-70 |
| Delicate Tissue Forceps | 138-143 |
| DEMEL Wire Guides | 660 |
| DENHARDT Mouth Gag | 22 |
| DENIS-BROWNE Abdominal Retractor | 305 |
| DENKER-UECKERMANN Cryothyrotomy Trocars | 728 |
| Deponettes | 738 |
| Depressors, Tongue | 12 |
| Depressors, Uterine | 447 |
| Depth Ruler for Laser Surgery | 451 |
| DERF Needle Holder | 363 |
| DERF TITE GRIP Needle Holder | 342 |
| DERJERINE Percussion Hammers | 2 |
| Dermal Punches | 20 |
| Dermatomes | 41-42 |
| DERRA-COOLEY ATRAUMATIC-GRIP Anastomosis Clamps | 559 |
| DERRA-DE BAKEY ATRAUMATIC-GRIP Anastomosis Clamps | 542 |
| DESCHAMPS Ligature Needles | 374-376 |
| DESJARDINS Gall Duct Probes | 415 |
| DESJARDINS Gall Stone Forceps | 419 |
| DESMARRES Vein Retractors | 222 |
| DEUCHER Abdominal Retractor | 299 |
| DEVIN ATRAUMATIC-GRIP Carotid Clamps | 524 |
| DIEFFENBACH Bulldog Clamps | 163 |
| DIETRICH-DE BAKEY ATRAUMATIC-GRIP Bulldog Clamps | 526 |
| DIETRICH-HEGEMANN DURACUT Vascular Scissors | 56 |
| DIETRICH-HEGEMANN Vascular Scissors | 96 |
| DIETRICH ATRAUMATIC-GRIP Aortic Clamps | 539 |
| DIETRICH Micro Bulldog Clamps | 162 |
| DIETRICH TITE GRIP Micro Needle Holders | 339 |
| DIETRICH Vascular Scissors | 97 |
| Dilating Bougies | 424 |
| Dilators and Intima Spatulas | 512 |
| Dilators, Aortic | 511 |
| Dilators, Common Bile Duct | 416 |
| Dilators, Trachea | 728 |
| Dilators, Uterine | 443-445 |
| Dilators, Vascular | 510 |
| DINGMANN Bone Holding Forceps | 624 |
| DINGMANN modif. Bone Holding Forceps | 624 |
| Directors | 314 |
| Directors, Enucleator | 378 |
| Dispensers, Brush | 752 |
| Dispensers, Wire Drills | 656-657 |

| | |
|---|-----------------------|
| Dissecting and Ligature Forceps | 564 |
| Dissecting and Ligature Forceps, ATRAUMATIC-GRIP | 186, 551 |
| Dissecting Forceps | 132-134, 180-189 |
| Dissecting Forceps, Delicate | 128-131 |
| Dissecting Forceps, TITE GRIP | 113-115 |
| Dissecting Scissors | 81-91, 95, 98 |
| Dissecting Scissors, Delicate | 92-93 |
| Dissecting Scissors, DURACUT | 47-54 |
| Dissecting Scissors, Micro | 65, 67 |
| Dissectors | 574, 693-694, 696-697 |
| Dissectors, Dura | 699-700 |
| DITTEL Catheter Guide | 425 |
| DIXON-LOVELACE Delicate Haemostatic Forceps | 169 |
| DIXON-OCHSNER (CRILE-RANKIN) Delicate Haemostatic Forceps | 167 |
| DIXON (PEAN) Haemostatic Forceps | 174 |
| DOCKHORN Retractors | 245 |
| Double Picks | 212 |
| DOUGLAS-BOZEMANN Uterine Dressing Forceps | 208 |
| DOUGLAS Antrum Trocar | 320 |
| DOUGLAS Cilia Forceps | 152 |
| DOYEN-BABY ATRAUMATIC-GRIP Intestinal Clamp Forceps | 391 |
| DOYEN-BABY Intestinal Clamp Forceps | 391 |
| DOYEN-STILLE Retractors | 247 |
| DOYEN Abdominal Retractors | 248-249 |
| DOYEN Abdominal Scissors | 106 |
| DOYEN ATRAUMATIC-GRIP Intestinal Clamp Forceps | 392-393 |
| DOYEN Director | 314 |
| DOYEN Intestinal Clamp Forceps | 392-393 |
| DOYEN Mallets | 618 |
| DOYEN Myoma Screws | 458 |
| DOYEN Polypus and Ovum Forceps | 457 |
| DOYEN Rib Raspatories | 495 |
| DOYEN Towel Clamps | 200 |
| DOYEN Vaginal Specula and Retractors | 439 |
| Dressing and Sponge Forceps | 204-207 |
| Dressing and Sponge Holding Forceps | 209-210 |
| Drill Guide Forceps | 650 |
| Drill Points for Cervical Traction Tongs | 689 |
| Drilling Chucks | 653 |
| Drills | 652 |
| Drills, Finger Nail | 645 |
| Drills, Hand | 653 |
| Drills, Hand Bone | 651-653 |
| Drills, Twist | 652 |
| Drills, Wire | 655 |
| Drums, Sterilizing | 743 |
| DUBOIS Decapitating (Embryotomy) Scissors | 109 |
| DUPLAY Uterine Tenaculum Forceps | 453 |
| Dura Dissectors | 699-700 |
| Dura Hooks | 217-218 |
| Dura Knives | 37 |
| Dura Protecting Forceps | 650 |
| Dura Retractors | 212 |
| Dura Scissors | 100 |
| Dura Separators | 698 |
| DURACUT Adnex Scissors | 54 |
| DURACUT Bandage Scissors | 673 |
| DURACUT Delicate Scissors | 45 |
| DURACUT Dissecting Scissors | 47-54 |
| DURACUT Episiotomy Scissors | 60 |
| DURACUT Gum Scissors | 55 |
| DURACUT Gynecological Scissors | 60 |
| DURACUT Iris Scissors | 45 |
| DURACUT Ligature Scissors | 353 |
| DURACUT Nasal Scissors | 58 |
| DURACUT Parametrium Scissors | 60 |
| DURACUT Perineum Scissors | 60 |
| DURACUT Plaster-of-Paris Shears | 676 |
| DURACUT Plastic Surgery Scissors | 45 |
| DURACUT Rectal Scissors | 59 |
| DURACUT Septum Scissors | 59 |
| DURACUT Surgical Scissors | 46 |
| DURACUT Uterine Scissors | 60 |
| DURACUT Vascular and Fistula Scissors | 45 |
| DURACUT Vascular Scissors | 56-57 |
| DURACUT Wire Cutters | 667 |
| DURACUT Wire Cutting Scissors | 665 |
| DURANTE Vascular and Tumor Forceps | 149 |
| DUVAL-COLLIN Intestinal and Tissue Grasping Forceps | 386 |

| | |
|--|---------|
| DUVAL-COLLIN Intestinal Forceps | 149 |
| DUVAL Intestinal and Tissue Grasping Forceps | 386-387 |
| DUVAL Intestinal Forceps | 149 |
| DUVAL TITE GRIP Intestinal and Tissue Grasping Forceps | 388 |
| Dynamometers | 6 |

E

| | |
|--|---------|
| Ear Dressing Forceps | 136-137 |
| Ear Hooklets | 213 |
| Ear Syringes | 332 |
| EASTMAN-RICHARDSON Retractors | 250 |
| EATON-BECKMANN Laminectomy Retractors | 280 |
| ECHLIN Bone Rongeurs | 634 |
| EDER Cotton Carrier | 409 |
| EICKEN-KILLIAN Antrum Wash Cannulae | 322 |
| EISELSBERG Ligature Scissors | 352 |
| Elevators | 574-575 |
| Embryotomy Scissors | 109 |
| EMMET Fistula Hook | 221 |
| EMMET Hook for Laser Surgery | 449 |
| EMMET Sponge and Dressing Forceps | 207 |
| Empyema Trocar | 318 |
| Enderectomy Set | 515 |
| Enderectomy Stripper | 514-515 |
| Endocervical Biopsy Curettes | 459-460 |
| Endometrial Biopsy Curette | 459 |
| Endometrial Suction Biopsy Curettes | 459 |
| Endospecula | 443 |
| Endospecula for Lasersurgery | 448 |
| ENGEL Plaster Saw | 679 |
| ENGL. MOD. Towel Clamps | 200 |
| Enterotomy Scissors | 109 |
| Enucleator Directors | 378 |
| Enucleators | 693 |
| Episiotomy Scissors | 107 |
| Episiotomy Scissors, DURACUT | 60 |
| ERRICO Burr | 652 |
| ESMARCH Cloth Scissors and Plaster-of-Paris Shears | 675 |
| ESMARCH Compression Bandage | 570 |
| ESMARCH Compression Tube | 570 |
| ESMARCH Plaster Knife | 679 |
| EUFRATE PASQUE TITE GRIP Needle Holders | 344 |
| Eustachian Catheters | 322 |
| EWALD Delicate Dissecting Forceps | 129 |
| EWALD Delicate Tissue Forceps | 140 |
| Examination & Measuring Instruments | 6 |
| Exploration and Coagulation Hooks | 215 |
| Extractors, Comedo | 19 |
| Eye Needles | 354 |

F

| | |
|---|--------------|
| FAHLBUSCH-HARDY Dissectors | 693 |
| FANSLER-IVES Anoscope | 407 |
| FARABEUF-ALEXANDER Rib Raspatories | 497 |
| FARABEUF-COLLIN Raspatories | 588 |
| FARABEUF-LAMBOTTE Bone Holding Forceps | 626 |
| FARABEUF Raspatories | 588 |
| FARABEUF Retractors | 227 |
| FARRELL (LATHBURY) Cotton Applicators | 316 |
| FAURE Peritoneum Forceps | 193 |
| FAVALORO Coronary Artery Scissors | 95 |
| FEHLAND ATRAUMATIC GRIP Sigmoid Anastomosis Forceps | 400-401 |
| FEILCHENFELD Splinter Forceps | 150 |
| FEIN Cotton Applicators | 317 |
| FERGUSON Operating Scissors | 80 |
| FERGUSON Surgical Suture Needles | 356 |
| FERGUSON (FRAZIER) Suction Cannulae | 323 |
| FERGUSON Bone Holding Forceps | 624 |
| FERRIS-SMITH-CUSHING Laminectomy Rongeurs | 713 |
| FERRIS-SMITH-KERRISON Laminectomy Punches | 709-710, 712 |
| FERRIS-SMITH Tissue Forceps | 147 |
| Files, Bone | 592, 594-595 |
| Finger Nail Drill | 645 |
| Finger Nail Instruments | 645 |
| Finger Retractors | 271 |

- Finger Ring Saws 645
- FINOCHIETTO-BABY-HAIGHT** Rib Spreaders from ALUMINIUM 501
- FINOCHIETTO-BABY** Rib Spreaders 503
- FINOCHIETTO-BURFORD** Rib Spreaders 503
- FINOCHIETTO-BURFORD** Rib Spreaders from ALUMINIUM 502
- FINOCHIETTO-INFANT** Rib Spreaders from ALUMINIUM 501
- FINOCHIETTO-RIENHOFF** Rib Spreaders 506
- FINOCHIETTO modif.** Rid Spreaders from ALUMINIUM 500
- FINOCHIETTO** Needle Holders 369
- FINOCHIETTO** Rib Spreaders 503
- FINOCHIETTO** Rib Spreaders from ALUMINIUM 501
- FINOCHIETTO** Thoracic and Ligature Forceps 564
- FINOCHIETTO TITE GRIP** Needle Holders 346
- FINSEN** Self-Retaining Retractors 270
- FISCH** Dura Retractor 212
- FISCHER** Tendon Stripper 646
- Fistula Hooks 221
- Fistula Knife 37
- Fistula Probes 314, 409
- Fistula Scissors 80
- Fistula Scissors, DURACUT 45
- Fixation Clamp for the Spermatic Cord 425
- Fixation Device for Abdominal Retractors 309
- Flap Knife 39
- FLETCHER (JAVERTS)** Dressing and Sponge Holding Forceps 210
- FOERSTER-BALLENGER** Dressing and Sponge Holding Forceps 209
- FOERSTER (FORBES)** Dressing and Sponge Holding Forceps 210
- FOERSTER** Abdominal Retractors 308
- FOMON** Bone Files 595
- FOMON** DURACUT Nasal Scissors 58
- FOMON** Hooks for Posterior Nares 221
- FOMON** Lower Lateral Scissors 81
- FOMON** Nasal Scissors 102
- FOMON** Plastic Surgery Scissors 82
- FOMON** Rasps 595
- FOMON TITE GRIP** Rasps 597
- FORBES (FOERSTER)** Dressing and Sponge Holding Forceps 210
- Forceps 478-480
- Forceps, Anastomosis and Intestinal Clamp 402
- Forceps, Applying and Removing for Bulldog Clamps 160, 527
- Forceps, Applying and Removing for Scalp Hemostasis Clips 691
- Forceps, Applying for Approximators 158
- Forceps, Applying for Vessel Clips 154-156
- Forceps, Approximation 378
- Forceps, ATRAUMATIC-GRIP, Delicate Haemostatic 165, 167
- Forceps, ATRAUMATIC-GRIP, Dissecting and Ligature 186, 551
- Forceps, ATRAUMATIC-GRIP, Haemostatic 176
- Forceps, ATRAUMATIC-GRIP, Hysterectomy 197
- Forceps, ATRAUMATIC-GRIP, Intestinal and Tissue Grasping 389
- Forceps, ATRAUMATIC-GRIP, Intestinal Clamp 391-393, 395-396
- Forceps, ATRAUMATIC-GRIP, Ligature and Dissecting 186, 551
- Forceps, ATRAUMATIC-GRIP, Sigmoid Anastomosis 400-401
- Forceps, ATRAUMATIC-GRIP, Stomach Clamp 397
- Forceps, ATRAUMATIC-GRIP, Tissue and Intestinal Grasping 389
- Forceps, ATRAUMATIC-GRIP, Vascular 135
- Forceps, Bone and Rib Holding 493
- Forceps, Bone Cutting 494, 637-639
- Forceps, Bone Holding 624-629
- Forceps, Bronchus 566
- Forceps, Caesarean Section Haemostatic 481
- Forceps, Capsule 423
- Forceps, Cartilage Grasping and Meniscus 640
- Forceps, Catheter Introducing 32
- Forceps, Cervical Biopsy and Specimen 460-465
- Forceps, Cilia 152
- Forceps, Clamp Closing 402
- Forceps, Clip Applying 690
- Forceps, Clip Applying and Removing 379
- Forceps, Cover Glass 152
- Forceps, Cranial Rongeur 688
- Forceps, Dissecting 132-134, 180-189
- Forceps, Dissecting and Ligature 564
- Forceps, Dissecting, Delicate 128-131
- Forceps, Dressing and Sponge 204-207
- Forceps, Dressing and Sponge Holding 209-210
- Forceps, Drill Guide 650
- Forceps, Dura Protecting 650
- Forceps, Ear Dressing 136-137
- Forceps, Gall Stone 418-419
- Forceps, Grasping 149
- Forceps, Guide 473
- Forceps, Haemorrhoidal 410
- Forceps, Haemostatic 173-179
- Forceps, Haemostatic, Delicate 164-172
- Forceps, Hysterectomy 194-196
- Forceps, Intestinal 149
- Forceps, Intestinal and Anastomosis Clamp 402
- Forceps, Intestinal and Tissue Grasping 383-388
- Forceps, Intestinal Clamp 390-394, 396
- Forceps, Intra Uterine Device (IUP) 447
- Forceps, Kidney Elevating 421
- Forceps, Kidney Stone 420-421
- Forceps, Ligature 152, 180-189
- Forceps, Ligature and Dissecting 564
- Forceps, Ligature and Thoracic 564
- Forceps, Ligature Carrying 423
- Forceps, Lung Dissecting 149
- Forceps, Membrane Puncturing 477
- Forceps, Meniscus and Cartilage Grasping 640
- Forceps, Micro 120-125
- Forceps, Micro Grasping 124
- Forceps, Micro Suture Tying 121-123
- Forceps, Microscopic 121
- Forceps, Nail Extracting 645
- Forceps, Nail Splitter 17
- Forceps, Nail Splitting 645
- Forceps, Nasal Dressing 136-137
- Forceps, Ovum and Placenta 482-483
- Forceps, Ovum and Polypus 457
- Forceps, Parametrium 197
- Forceps, Patella 623
- Forceps, PERFECT GRIP, Micro Grasping 124
- Forceps, PERFECT GRIP, Micro Suture Tying 123
- Forceps, Peritoneum 192-193
- Forceps, Pick-Up 735
- Forceps, Placenta and Ovum 482-483
- Forceps, Polypus and Ovum 457
- Forceps, Prostatic Lobe Holding 423
- Forceps, Rectal Biopsy Specimen 412
- Forceps, Removing and Applying for Bulldog Clamps 160, 527
- Forceps, Removing and Applying for Scalp Hemostasis Clips 691
- Forceps, Reposition 622-623
- Forceps, Rib and Bone Holding 493
- Forceps, Scalp Flap 481
- Forceps, Sequestrum 623
- Forceps, Sigmoid Anastomosis 400
- Forceps, Sinus 204
- Forceps, Specimen and Cervical Biopsy 460-465
- Forceps, Splinter 150-151
- Forceps, Sponge and Dressing 204-207
- Forceps, Sponge Holding and Dressing 209-210
- Forceps, Sterilizing 734-735
- Forceps, Tendon Holding 648
- Forceps, Tendon Interlacing 649
- Forceps, Tendon Passing 649
- Forceps, Tendon Seizing 647
- Forceps, Thoracic and Ligature 564
- Forceps, Tissue 144-148
- Forceps, Tissue and Intestinal Grasping 383-388
- Forceps, Tissue Seizing 148
- Forceps, Tissue, Delicate 138-143
- Forceps, TITAN LINE Haemostatic, Delicate 164, 166, 168
- Forceps, TITE GRIP, Dissecting 113-115
- Forceps, TITE GRIP, Intestinal and Tissue Forceps 388
- Forceps, TITE GRIP, Micro 118
- Forceps, TITE GRIP, Needlepulling Tissue 116
- Forceps, TITE GRIP, Splinter 151
- Forceps, TITE GRIP, Suture Tying 113
- Forceps, TITE GRIP, Tissue 117
- Forceps, TITE GRIP, Tissue and Intestinal Forceps 388
- Forceps, TITE GRIP, Wire Holding 663
- Forceps, TITE GRIP, Wire Twisting 662
- Forceps, Tongue Holding 23
- Forceps, Tonsil 179
- Forceps, Tumor 148-149
- Forceps, Tumor and Tissue Grasping 126-127
- Forceps, Tunneling Tubes 517
- Forceps, Uterine Dressing 208

| | |
|---|---------|
| Forceps, Uterine Elevating | 458 |
| Forceps, Uterine Tenaculum | 452-456 |
| Forceps, Vascular | 148-149 |
| Forceps, Wire Holding | 663-664 |
| FORD-DEAVER Retractors and Lung Spatulas | 263 |
| Forearm and Deep Hand Retractor | 271 |
| Fork, Implant | 693 |
| FOSS Retractors and Lung Spatulas | 263 |
| FOX-GOLDMAN DURACUT Gum Scissors | 55 |
| FOX-GOLDMAN Gum Scissors | 94 |
| FOX Lupus Curettes | 20 |
| FRANZ Abdominal Retractor | 304 |
| FRAZIER (FERGUSSON) Suction Cannulae | 323 |
| FRAZIER Dura and Skin Retractor | 216 |
| FRAZIER Dura Separator | 698 |
| FRAZIER Suction Cannulae | 323 |
| FREER Chisels | 607 |
| FREER Raspatories | 583 |
| FREER Retractor | 218 |
| FRENCH EYE TITE GRIP Needle Holders | 340 |
| FRENZEL Tongue Depressor | 12 |
| FREY-SAUERBRUCH Rib Shears | 493 |
| FRIEDMAN-LUER Bone Rongeur | 631 |
| FRITSCH Retractors | 250 |
| FROHN Cotton Applicators | 316 |
| Front and Lateral Cutter | 668 |
| FRYKHOLM Bone Rongeurs | 635 |
| Funnels | 751 |

G

| | |
|--|---------|
| Galea Hooks | 691 |
| Gall Bladder Scoop | 417 |
| Gall Bladder Trocars | 318 |
| Gall Duct Probes | 415 |
| Gall Stone Forceps | 418-419 |
| Gall Stone Probe | 415 |
| Gall Stone Scoops | 417 |
| GALLAHER Rasp | 592 |
| GANSKE-BIRCHER Meniscus and Cartilage Grasping Forceps | 640 |
| GARRET (DE BAKEY) Vascular Dilators | 510 |
| GAYLOR-THOMS Cervical Biopsy and Specimen Forceps | 460 |
| GEISSENDOERFER-OVERHOLT Dissecting and Ligature Forceps | 184 |
| GELPI-BABY Vaginal Retractor | 281 |
| GELPI-SELETZ Vaginal Retractors | 281 |
| GELPI Vaginal Retractors | 281 |
| GEMINI-MIXTER Dissecting and Ligature Forceps | 181 |
| GEMINI Dissecting and Ligature Forceps | 181 |
| Genito-Urinary Instruments | 425-426 |
| GERALD Delicate Dissecting Forceps | 130 |
| GERALD Delicate Tissue Forceps | 142 |
| GERALD TITE GRIP Dissecting Forceps | 114 |
| GERALD TITE GRIP Tissue Forceps | 117 |
| GERSTER Traction Bar for Bone Clamps | 630 |
| GERZOG Mallet | 618 |
| GIBBON-BAILEY Rib Contractor | 508 |
| GIERTZ-STILLE Rib Shears | 492 |
| GIGLI (OLIVECRONA) Wire Saws | 687 |
| GIGLI Hook Handles for Wire Saws | 687 |
| GIL-VERNET (MARBERGER) Vein and Hilar Retractors | 223 |
| GILLIES-BABY Needle Holders with Scissors | 370 |
| GILLIES-BABY TITE GRIP Needle Holder | 348 |
| GILLIES (CONVERSE) Dura and Skin Retractors | 216 |
| GILLIES Delicate Tissue Forceps | 142 |
| GILLIES Needle Holders with Scissors | 370 |
| GILLIES Skin Retractor | 216 |
| GILLIES TITE GRIP Needle Holders | 348 |
| GILLIES TITE GRIP Tissue Forceps | 117 |
| Glass Pipette for Micro-Bloodletting | 473 |
| GLASSMANN (KILNER) Surgical and Dissecting Scissors | 83 |
| GLOVER-DE BAKEY ATRAUMATIC-GRIP Bulldog Clamps | 525 |
| GLOVER ATRAUMATIC-GRIP Anastomosis Clamps | 544 |
| GLUCK Rib Shears | 492 |
| GOELET Retractor | 229 |
| Goitre Retractor | 224 |
| GOLDMAN-FOX DURACUT Gum Scissors | 55 |
| GOLDMAN-FOX Gum Scissors | 94 |
| Goniometer | 7 |

| | |
|---|--------------|
| GOOD Tonsil Scissors | 103 |
| GOODELL Uterine Dilator | 443 |
| GORNEY DURACUT Septum Scissors | 59 |
| GORNEY Plastic Surgery Scissors | 82 |
| GOSSET-BABY Abdominal Retractor | 299 |
| GOSSET Abdominal Retractors | 299-300 |
| Gouge Blades, Interchangeable | 611 |
| Gouges | 607, 609-616 |
| Gouges for Scoliosis Operations | 614 |
| Gouges, Spinal | 616 |
| Gouges, Spongiosa | 615 |
| GOURDET Uterine Scoops | 466 |
| GRAEFE (TYRELL) Skin Retractors | 216 |
| GRAEFE Delicate Dissecting Forceps | 128 |
| GRAEFE Delicate Tissue Forceps | 139 |
| GRAEFE Strabismus Hooks | 213 |
| GRAEFE Tissue Forceps | 148 |
| GRAHAM Dura Hook | 217 |
| GRAMCKO-BUCK Bone Lever | 576 |
| Grasping Forceps | 149 |
| GRAVE modif. Vaginal Specula | 432 |
| GRAVE Vaginal Specula | 432-433 |
| GREEN-ARMYTAGE Caesarean Section Haemostatic Forceps | 481 |
| GREEN-SENN Retractors | 224 |
| GREEN Thyroid Gland Retractor | 243 |
| GREEN Towel Clamps | 200 |
| GREGORY-SOFT ATRAUMATIC-GRIP Carotid Clamps | 527 |
| GREGORY ATRAUMATIC-GRIP Profunda Clamps | 534 |
| GRONINGEN Nerve and Vessel Hooks | 215 |
| GROSS Sponge and Dressing Forceps | 204 |
| GRUENWALD-LOVE Laminectomy Rongeurs | 716 |
| GRUENWALD (JANSEN) Ear and Nasal Dressing Forceps | 136 |
| GRUENWALD Ear and Nasal Dressing Forceps | 136 |
| Guide Forceps | 473 |
| Guide Needles | 334 |
| Guides, Catheter | 425 |
| Guides, Ligature | 697 |
| Guides, Wire | 660-661 |
| Gum Scissors | 94 |
| Gum Scissors, DURACUT | 55 |
| GUNNAR-HEY Tube Milking Roller | 203 |
| GUTHRIE Skin Retractors | 218 |
| GUYON-DE BAKEY ATRAUMATIC-GRIP Kidney Clamps | 190 |
| GUYON Catheter Guide | 425 |
| GUYON Catheter Introducing Instrument | 425 |
| GUYON Kidney Clamp | 190 |
| Gynecological Scissors, DURACUT | 60 |

H

| | |
|---|---------------|
| HABERER Abdominal and Intestinal Spatula | 267 |
| Haemorrhoidal Forceps | 410 |
| Haemorrhoidal Ligators | 410 |
| Haemorrhoidal Suction Ligators | 411 |
| Haemostatic Forceps | 173-179 |
| Haemostatic Forceps, ATRAUMATIC-GRIP | 176 |
| Haemostatic Forceps, Delicate | 164-172 |
| Haemostatic Forceps, TITAN LINE, Delicate | 164, 166, 168 |
| HAIGHT-FINOCHIETTO-BABY Rib Spreaders from ALUMINIUM | 501 |
| HAIGHT Rib Spreaders | 506 |
| HAJEK-KOFLER Laminectomy Punches | 708 |
| HAJEK Mallets | 617 |
| HALLE Bone Curettes | 604 |
| HALLE Dura Knife | 37 |
| HALLE Intima Spatulas | 512 |
| HALLE Raspatory | 582 |
| HALSEY Needle Holder | 363 |
| HALSEY TITE GRIP Needle Holder for Left-Hander | 341 |
| HALSEY TITE GRIP Needle Holders | 342 |
| HALSTED-MICRO Delicate Haemostatic Forceps | 164 |
| HALSTED-MOSQUITO-DE BAKEY ATRAUMATIC-GRIP Delicate Haemostatic Forceps | 165 |
| HALSTED-MOSQUITO (HEISS) Delicate Haemostatic Forceps | 170 |
| HALSTED-MOSQUITO Delicate Haemostatic Forceps | 164-165 |
| HALSTED-MOSQUITO TITAN LINE Delicate Haemostatic Forceps | 164 |
| HALSTED Delicate Haemostatic Forceps | 169, 171 |
| Hammers | 2-3 |
| Hand and Carpal Tunnel Retractor | 271 |

- Hand Bone Drill 651-653
 Hand Drill 653
 Handles for Interchangeable Chisel Blades 611
 Handles for Interchangeable Gouge Blades 611
 Handles for Interchangeable Osteotome Blades 611
 Handles, Hook for Wire Saws 687
 Handles, Laryngeal Mirrors 13
 Handles, Scalpel 34-35
 Handles, Traction for Forceps 479
 Handrestrainer 644
 Hands, Lead 644
HARDY-FAHLBUSCH Dissectors 693
HARDY Curettes 692
HARDY Dissectors 693
HARDY Enucleators 693
HARDY Implant Fork 693
HARKEN-DE BAKEY ATRAUMATIC-GRIP Dissecting and
 Ligature Forceps 551
HARRINGTON-MAYO Dissecting Scissors 86
HARRINGTON Retractors and Lung Spatulas 262
HARTMANN-COLLIN Retractor 229
HARTMANN (BABY-MOSQUITO) Delicate Haemostatic Forceps 164
HARTMANN Cervical Biopsy and Specimen Forceps 462
HARTMANN Eustachian Catheters 322
HARTMANN Tuning Forks 4
HASSETLINE Umbilical Cord Clamps 486
HAVERFIELD-SCOVILLE Self-Retaining Retractors 286
HAYES ATRAUMATIC-GRIP Sigmoid Anastomosis Forceps 400
 Head Bands 10-11
 Head Extractor 481
 Head Lamps 11
 Head Light 11
 Head Mirrors 10
HEANEY-BALLENTINE Hysterectomy Forceps 196
HEANEY-DE BAKEY (ROGERS) Hysterectomy Forceps 197
HEANEY-REZEK Hysterectomy Forceps 196
HEANEY-SIMON Retractor for Deep Surgery 254
HEANEY Hysterectomy Forceps 196
HEANEY Needle Holders 369
HEANEY Tissue Forceps 147
HEANEY TITE GRIP Needle Holders 346
HEATH-RICHTER Clip Removing Forceps 379
HEATH Mallet 620
HEGAR-BAUMGARTNER TITE GRIP Needle Holder 342
HEGAR-CORWIN TITE GRIP Wire Twisting Forceps 662
HEGAR-MAYO Needle Holders 367
HEGAR-MAYO TITE GRIP Needle Holders 345
HEGAR-MAYO TITE GRIP Needle Holders for Left-Hander 341
HEGAR-OLSEN-BABY TITE GRIP Needle Holder 348
HEGAR-OLSEN Needle Holders with Scissors 370
HEGAR-OLSEN TITE GRIP Needle Holders 348
HEGAR Uterine Dilators 444-445
HEGEMANN-DIETRICH DURACUT Vascular Scissors 56
HEGEMANN-DIETRICH Vascular Scissors 96
HEGENBARTH Clip Applying Forceps 379
HEIFETZ Brain Spatulas 706
HEIFETZ Tumor and Tissue Grasping Forceps 127
HEISS (HALSTED-MOSQUITO) Delicate Haemostatic Forceps 170
HEISS (MIXTER-PAUL) Dissecting and Ligature Forceps 182
HEISTER Mouth Gag 22
 Hemi-Laminectomy Retractors 277
HEMINGWAY Bone Curettes 599
HENLEY Self-Retaining Retractors 282-283
HENNIG Plaster Spreader 682
HERRICK Kidney Pedicle Clamp 191
HEY-GUNNAR Tube Milking Roller 203
HEYMANN DURACUT Nasal Scissors 58
HEYMANN Nasal Scissors 101
HEYWOOD-SMITH Polypus and Ovum Forceps 457
HEYWOOD-SMITH Tongue Holding Forceps 23
 Hib Levers 580
HIBBS Retractors 231
HIBBS Spinal Retractors 231
 Hilar Retractors 223
HIRSCHMANN Anoscopes 407
HOEN Raspatories 586
HOGLUND-LOWMAN Bone Clamp 630
HOHMANN-ALDINGER Bone Lever 580
HOHMANN-LANGE Bone Lever 577
HOHMANN-LANGE modif. Bone Lever 577
HOHMANN-MINI Bone Levers 576
HOHMANN Bone Levers 578-580
HOKE Osteotomes 607
HOLSHER Nerve Root Retractor 701
HOLZBACH Hysterectomy Forceps 194
 Hook Handles for Wire Saws 687
 Hooklets, Ear 213
 Hooks 696
 Hooks, Bulbus 422
 Hooks, **CASPAR** Self-Retaining Retractors 289
 Hooks, Coagulation and Exploration 215
 Hooks, Crypt 409
 Hooks, Decapitating 485
 Hooks, Decompression 701
 Hooks, Dura 217-218
 Hooks, Exploration and Coagulation 215
 Hooks, Fistula 221
 Hooks, Galea 691
 Hooks, Laser Surgery 449
 Hooks, Nerve 213-215
 Hooks, Plastic Surgery 217-218, 226
 Hooks, Posterior Nares 221
 Hooks, **SCOVILLE** Self-Retaining Retractors 287
 Hooks, Spring for Galea Fixation 691
 Hooks, Strabismus 213
 Hooks, Suture 518
 Hooks, Vessel 213-215
HOPKINS-JOHNS Applying and Removing Forceps for Bulldog Clamps 527
HOPKINS-JOHNS Bulldog Clamps 163
HOPKINS Plaster Knives 679
HORGAN Central Valve for Abdominal Retractors 303
HORNE-JOBSON Cotton Applicators 317
HORSLEY-LISTON-KEY Bone Cutting Forceps 494
HORSLEY Dura Separator 698
HÖSEL Retractors 246
HOSPITAL-PROVIDENCE Delicate Haemostatic Forceps 168
HOUSE Bone Curettes 598
HOWARD Raspatory 583
HRYNTSCHAK-YOUNG Boomerang Needle Holder 372
HUDSON Hand Bone Drill 652
HULKA-KENWICK Uterine Tenaculum Forceps 453
HULKA Uterine Tenaculum Forceps 453
HUMBY Dermatome 42
HUNTER Splinter Forceps 150
HURD Ligature Needles 374
 Hysterectomy Forceps 194-196
 Hysterectomy Forceps ATRAUMATIC-GRIP 197
 Hystero-Salpingography Instrumentation 474
- I
- Identification Labels 743
 Iliac Clamps, ATRAUMATIC-GRIP 558
 Implant Fork 693
 Incision Scissors 80
INFANT-FINOCHIETTO Rib Spreaders from ALUMINIUM 501
INGE Lamina Spreaders 296
 Injection Needle 486
 Instrument Boxes 746
 Instrument Care Lubricant 733
 Instrument Storing Trays 748
 Insuline Syringes 330
 Interosseous Knife 39
 Intestinal and Anastomosis Clamp Forceps 402
 Intestinal and Stomach Clamps 403
 Intestinal and Stomach Suturing Apparatus 404
 Intestinal and Tissue Grasping Forceps 383-388
 Intestinal and Tissue Grasping Forceps, ATRAUMATIC-GRIP 389
 Intestinal and Tissue Grasping Forceps, TITE GRIP 388
 Intestinal Clamp Forceps 390-394, 396
 Intestinal Clamp Forceps, ATRAUMATIC GRIP 391-393, 395-396
 Intestinal Forceps 149
 Intestinal Needles 354
 Intestinal Spatulas 266-267
 Intima Knife 513
 Intima Spatulas 512-513
 Intima Spatulas and Dilators 512

| | |
|------------------------------------|-----|
| Intra Uterine Device (IUP) Forceps | 447 |
| Intracardiac Suction Tube | 327 |
| IOWA Injection Needle | 486 |
| IOWA Membrane Puncturing Forceps | 477 |
| IOWA Trumpet Needle Guide | 486 |
| Iris Scissors, DURACUT | 45 |
| Irrigators | 751 |
| ISRAEL Retractors | 237 |
| IUD (Intra Uterine Device) Forceps | 447 |
| IVES-FANSLER Anoscope | 407 |

J

| | |
|--|----------|
| JACKSON-CHEVALIER Trachea Tubes | 726 |
| JACKSON Tendon Seizing Forceps | 647 |
| JACKSON Trachea Retractor | 217, 226 |
| JACKSON Vaginal Specula | 438 |
| JACOBS Uterine Tenaculum Forceps | 456 |
| JACOBSON Buttoned Probe | 694 |
| JACOBSON Micro Scissors | 64 |
| JACOBSON PERFECT GRIP Micro Needle Holders | 359 |
| JACOBSON Suture Pusher | 694 |
| JACOBSON TITE GRIP Micro Needle Holders | 338 |
| JACOBSON Twin Probe | 694 |
| JACOBSON Vessel Knife | 694 |
| JAMESON Delicate Dissecting Scissors | 93 |
| JAMESON Needle Holders | 368 |
| JANET Barrels | 331 |
| JANET Wound and Bladder Syringes | 331 |
| JANSEN-ZAUFAL Bone Rongeur | 633 |
| JANSEN (GRUENWALD) Ear and Nasal Dressing Forceps | 136 |
| JANSEN Bone Curettes | 599 |
| JANSEN Bone Rongeurs | 632 |
| JANSEN Ear and Nasal Dressing Forceps | 136 |
| JANSEN Head Lamp | 11 |
| JANSEN Raspatory | 587 |
| JANSEN Self-Retaining Retractors | 272 |
| Jars | 747 |
| JAVERTS (FLECHTER) Dressing and Sponge Holding Forceps | 210 |
| JAVID ATRAUMATIC-GRIP Carotid Clamps | 537 |
| JOHNSON-HORNE Cotton Applicators | 317 |
| JOHNS-HOPKINS Applying and Removing Forceps for Bulldog Clamps | 527 |
| JOHNS-HOPKINS Bulldog Clamps | 163 |
| JONES-LELAND ATRAUMATIC-GRIP Peripheral Vascular Clamps | 534 |
| JONES Towel Clamps | 200 |
| JORGENSON Dissecting Scissors | 98 |
| JOSEPH Bone File | 592 |
| JOSEPH DURACUT Plastic Surgery Scissors | 45 |
| JOSEPH Hooks for Plastic Surgery | 217, 219 |
| JOSEPH Plastic Surgery Scissors | 70 |
| JOSEPH Raspatory | 582 |
| JOSEPH Rhinoplastic Knife | 37 |
| JUDD-ALLIS Intestinal and Tissue Grasping Forceps | 384 |
| JUDD-MASSON Bladder Retractor | 310 |

K

| | |
|--|----------|
| KADER Abdominal and Intestinal Spatulas | 267 |
| KALLMORGEN Vaginal Specula and Retractors | 434 |
| KALT Needle Holder | 363 |
| KALT Vascular Suture Needles | 354 |
| KATSCH Comedo Extractor | 19 |
| KAY-LAMBERT ATRAUMATIC-GRIP Aorta-Anastomosis Clamps | 549 |
| KAZANJIAN Bone Cutting Forceps | 637 |
| KELLY-BABY Delicate Haemostatic Forceps | 168 |
| KELLY-RANKIN Delicate Haemostatic Forceps | 169 |
| KELLY Delicate Haemostatic Forceps | 168 |
| KELLY DURACUT Vascular and Fistula Scissors | 45 |
| KELLY Polypus and Ovum Forceps | 457 |
| KELLY Retractors | 251, 255 |
| KELLY Retractors for Deep Surgery | 255 |
| KELLY Sphincteroscopes | 407 |
| KELLY TITAN LINE Delicate Haemostatic Forceps | 168 |
| KELLY Vascular and Fistula Scissors | 80 |
| KENWICK-HULKA Uterine Tenaculum Forceps | 453 |
| KERN-LANE Bone Holding Forceps | 625 |
| KERN-MINI Bone Holding Forceps | 625 |

| | |
|---|---------------|
| KERRISON-LOVE (COLCLOUGH) Laminectomy Punches | 710-711 |
| KERRISON-SMITH-FERRIS Laminectomy Punches | 709-710, 712 |
| KERRISON Laminectomy Punches | 707 |
| KEVOURKIAN-PACIFIC Cervical Biopsy and Specimen Forceps | 464 |
| KEVOURKIAN-YOUNGE Cervical Biopsy and Specimen Forceps | 463, 465 |
| KEVOURKIAN-YOUNGE Endocervical Biopsy Curettes | 459 |
| KEY-LISTON-HORSLEY Bone Cutting Forceps | 494 |
| KEY Raspatories | 589 |
| KEYES Dermal Punch Set | 20 |
| KEYES Dermal Punches | 20 |
| Kidney Bowls | 750 |
| Kidney Clamps | 190 |
| Kidney Clamps, ATRAUMATIC-GRIP | 190 |
| Kidney Elevating Forceps | 421 |
| Kidney Pedicle Clamps | 191 |
| Kidney Stone Forceps | 420-421 |
| KIELAND-LUIKART Forceps | 479 |
| KIELAND Forceps | 479 |
| KILLIAN-EICKEN Antrum Wash Cannulae | 322 |
| KILLIAN (MÜHLING) Septum Scissors | 102 |
| KILLIAN Raspatories | 583 |
| KILNER (GLASSMANN) Surgical and Dissecting Scissors | 83 |
| KILNER Delicate Dissecting Scissors | 93 |
| KILNER Skin Retractors | 216 |
| KILNER TITE GRIP Needle Holder | 342 |
| KIRK Mallet | 618 |
| KIRKLIN Vein Retractors | 223 |
| KIRSCHNER-BALFOUR Valve for Abdominal Retractors | 307 |
| KIRSCHNER Abdominal Retractors | 306 |
| KIRSCHNER Ligature Conductor | 377 |
| KIRSCHNER Valves for Abdominal Retractors | 307 |
| KIRSCHNER Wire Drills | 655 |
| KIRSCHNER Wire Traction Bows | 658-659 |
| KLAPP Tendon Sheath Retractor | 225 |
| KLEINERT-KUTZ Tendon Passing Forceps | 649 |
| KLEINSCHMIDT Spur Crusher and Appendectomy Clamp | 403 |
| KLIMA-ROSEGGER Sternum Puncture Needles | 329, 518 |
| KLINGENBERGH-LOTH Dissecting Scissors | 98 |
| KNAPP Delicate Surgical Scissors | 68 |
| KNAPP Retractors | 218 |
| KNIGHT DURACUT Nasal Scissors | 58 |
| KNIGHT Nasal Scissors | 101 |
| Knives, Amputation | 38-39 |
| Knives, Autopsy | 40 |
| Knives, Brain | 40 |
| Knives, Dura | 37 |
| Knives, Fistula | 37 |
| Knives, Flap | 39 |
| Knives, Interosseous | 39 |
| Knives, Intima | 513 |
| Knives, Meniscus | 642-643 |
| Knives, Periosteum | 39 |
| Knives, Phalangeal | 39 |
| Knives, Plaster | 679 |
| Knives, Post Mortem | 40 |
| Knives, Resection | 38-39 |
| Knives, Rhinoplastic | 37 |
| Knives, Vessel | 694-695 |
| Knot Tier and Ligature Adjuster | 378 |
| KNOWLES Bandage Scissors | 673 |
| KNUTSON Urethrography Instrument | 426 |
| KOCHER-BABY ATRAUMATIC-GRIP Intestinal Clamp Forceps | 391 |
| KOCHER-BABY Intestinal Clamp Forceps | 391 |
| KOCHER-LANGENBECK Retractors | 240 |
| KOCHER-OCHSNER Haemostatic Forceps | 177 |
| KOCHER ATRAUMATIC-GRIP Intestinal Clamps | 395 |
| KOCHER Bladder Spatula | 268 |
| KOCHER Director Eucleator | 378 |
| KOCHER Haemostatic Forceps | 176 |
| KOCHER Intestinal Clamp Forceps | 392-394 |
| KOCHER Retractors | 235, 242, 244 |
| KOCHER Retractors and Bone Retractors | 232 |
| KOENIG Ligature Conductors | 377 |
| KOERTE-LUER Gall Stone Scoops | 417 |
| KOERTE Retractors | 236 |
| KOFLER-HAJEK Laminectomy Punches | 708 |
| KOGAN Endospecula | 443 |
| KOGAN Endospecula for Laser Surgery | 448 |
| KOGLER-CRAIG Vertebral Biopsy Instruments | 720-721 |

| | |
|--|---------|
| KÖLN MOD. Scalp Hemostasis Clips | 691 |
| KÖNIG-ROSER Mouth Gag | 22 |
| KÖNIG Raspatory | 582 |
| KONRICH Sterilizing Drums | 743 |
| KOOS Vessel Knives | 695 |
| KRAUS Vessel Knife | 695 |
| KRAUSE Antrum Trocar | 319 |
| KRAYENBÜHL Nerve and Vessel Hooks | 215 |
| KRISTELLER Vaginal Specula and Retractors | 434-437 |
| KROENLEIN Haemostatic Forceps | 173 |
| KRONECKER Ligature Needles | 374 |
| KÜHNE Cover Glass Forceps | 152 |
| KUTZ-KLEINERT Tendon Passing Forceps | 649 |

L

| | |
|--|------------------------|
| LA GRANGE Gum Scissors | 94 |
| Labels, Identification | 743 |
| Lable Rack | 743 |
| LABORDE Trachea Dilator | 728 |
| Lachrymal Probes | 312 |
| LAHEY-SWEET Dissecting and Ligature Forceps | 189 |
| LAHEY Dissecting and Ligature Forceps | 189 |
| LAHEY Goitre Retractor | 224 |
| LAHEY Retractors | 219 |
| LAHEY Uterine Tenaculum Forceps | 454 |
| LAMBERT-KAY ATRAUMATIC-GRIP Aorta-Anastomosis Clamps | 549 |
| LAMBERT-LOWMAN Bone Clamp | 630 |
| LAMBOTTE-FARABEUF Bone Holding Forcpes | 626 |
| LAMBOTTE-MINI Osteotomes | 608 |
| LAMBOTTE Bone Holding Forcpes | 626-627 |
| LAMBOTTE Osteotomes | 608 |
| LAMBOTTE Rib Raspatories | 497 |
| Lamina Spreaders | 296 |
| Laminectomy Punches | 707-712 |
| Laminectomy Retractors | 276, 279-280, 284, 286 |
| Laminectomy Rongeurs | 713-719 |
| LANDAU-COLLIN Vaginal Specula | 431 |
| LANDAU Vaginal Specula | 440 |
| LANDOLT-CUSHING Specula for Trans-Sphenoidal Hypophysectomy | 692 |
| LANDOLT Raspatory | 585 |
| LANE-KERN Bone Holding Forcpes | 625 |
| LANE-MURPHY Luxation Lever | 581 |
| LANE Bone Holding Forcpes | 625 |
| LANE Towel Clamps | 201 |
| LANGE-HOHMANN Bone Lever | 577 |
| LANGE-HOHMANN modif. Bone Lever | 577 |
| LANGE Bandage Scissors | 672 |
| LANGENBECK-KOCHER Retractors | 240 |
| LANGENBECK-MINI Retractors | 224 |
| LANGENBECK-PARKER (US-ARMY) Retractors | 231 |
| LANGENBECK-RYDER TITE GRIP Needle Holders | 350 |
| LANGENBECK Amputation and Resection Saw | 572 |
| LANGENBECK Bone Holding Forcpes | 624 |
| LANGENBECK Elevators | 575 |
| LANGENBECK Flap Knife | 39 |
| LANGENBECK Raspatories | 587 |
| LANGENBECK Resection Knives | 38 |
| LANGENBECK Retractors | 238-239 |
| LANGENBECK TITE GRIP Needle Holders | 350 |
| Laryngeal Mirrors | 13-14 |
| Laryngoscopes | 24-31 |
| Laser Surgery Instruments | 448-451 |
| Lateral and Front Cutter | 668 |
| Lateral Speculum for Lasersurgery | 448 |
| Lateral Valves for SCOVILLE Self-Retaining Retractors | 287 |
| Lateral Valves for TAYLOR Self-Retaining Retractors | 287 |
| LATHBURY (FARRELL) Cotton Applicators | 316 |
| LAWRENCE Dissecting and Ligature Forceps | 187 |
| LAWTON-MATHIEU TITE GRIP Needle Holder | 349 |
| LAWTON TITE GRIP Needle Holder | 349 |
| LAZAR Micro Suture Tying Forceps | 121 |
| Lead Hands | 644 |
| LEBSCHÉ Sternum Chisel | 492 |
| LEES ATRAUMATIC-GRIP Bronchus Clamps | 552 |
| Left-Hander Needle Holders, TITE GRIP | 341 |
| Left Ventricular Sump Suction Tube | 327 |
| LEGUEU Bladder Spatula | 268 |
| LEKSELL-STILLE Bone Rongeurs | 635 |
| LELAND-JONES ATRAUMATIC-GRIP Peripheral Vascular Clamps | 534 |
| LEMMON Intima Spatulas | 512 |
| LEMPERT Bone Curettes | 604 |
| LEMPERT Bone Rongeurs | 631-632 |
| LEMPERT Raspatories | 584 |
| Lenses, Accessory | 9 |
| LERICHE Delicate Haemostatic Forceps | 165 |
| Levers, Bone | 576-581 |
| Levers, Hib | 580 |
| Levers, Luxation | 581 |
| Levers, Obstetric | 481 |
| LEWIN Reposition Forceps | 622 |
| LEWIS Rasps | 592 |
| LEXER-BABY Dissecting Scissors | 87 |
| LEXER-MAYO Dissecting Scissors | 87 |
| LEXER-MAYO DURACUT Dissecting Scissors | 48 |
| LEXER-MINI Osteotomes | 612 |
| LEXER Dissecting Scissors | 87 |
| LEXER DURACUT Dissecting Scissors | 49 |
| LEXER Gouges | 613 |
| LEXER Osteotomes | 612-613 |
| LEXER Spongiosa Gouges | 615 |
| LEYLA Self-Retaining Brain Retractors | 702-705 |
| LICHTENBERG TITE GRIP Needle Holder | 349 |
| LICHTWITZ Antrum Trocar Needles | 319 |
| LICHTWITZ Antrum Trocars | 320 |
| LICHTWITZ V. EICKEN Antrum Trocar Needles | 319 |
| Ligators, Haemorrhoidal | 410 |
| Ligature Adjuster and Knot Tier | 378 |
| Ligature and Dissecting Forceps | 564 |
| Ligature and Dissecting Forceps, ATRAUMATIC-GRIP | 186, 551 |
| Ligature and Thoracic Forceps | 564 |
| Ligature Carrying Forceps | 423 |
| Ligature Conductors | 377-378 |
| Ligature Forceps | 152, 180-189 |
| Ligature Guides | 697 |
| Ligature Needles | 374-376 |
| Ligature Rubber Rings | 410 |
| Ligature Scissors | 352 |
| Ligature Scissors, DURACUT | 353 |
| LINDORF TITE GRIP Wire Twisting Forceps | 662 |
| Liquid Concentrate for Surgical Instrument Care | 733 |
| LISTER Bandage and Cloth Scissors | 674 |
| LISTER Bandage Scissors | 673 |
| LISTER DURACUT Bandage Scissors | 673 |
| LISTER modif. Bandage Scissors | 673 |
| LISTER Sinus Forceps | 204 |
| LISTON-KEY-HORSLEY Bone Cutting Forceps | 494 |
| LISTON-LITTAUER Bone Cutting Forceps | 637 |
| LISTON-RUSKIN Bone Cutting Forceps | 638 |
| LISTON-WALTON (BÖHLER) Bone Cutting Forceps | 638 |
| LISTON Amputation Knives | 38 |
| LISTON Bone Cutting Forceps | 637, 639 |
| LITTAUER-LISTON Bone Cutting Forceps | 637 |
| LITTAUER Cilia Forceps | 152 |
| LITTAUER Ligature Scissors | 352 |
| LITTLER Dissecting Scissors | 81 |
| Liver Blind Puncture Needles | 329 |
| Liver Puncture Controlled Needles | 329 |
| Liver Retractors | 255 |
| Lobectomy Scissors | 99 |
| LOCKHART-MUMMERY Fistula Probe | 314 |
| LOCKLIN DURACUT Gum Scissors | 55 |
| LOCKLIN Gum Scissors | 94 |
| LOCKWOOD Intestinal and Tissue Grasping Forceps | 386 |
| LONG Hysterectomy Forceps | 194 |
| LORNA Towel Clamps | 202 |
| LOTH-KLINGENBERGH Dissecting Scissors | 98 |
| LOTH-SCHOEMAKER Ligature Scissors | 352 |
| LOUTE Wire Tightener | 660 |
| LOVE-GRUENWALD Laminectomy Rongeurs | 716 |
| LOVE-KERRISON (COLCLOUGH) Laminectomy Punches | 710-711 |
| LOVE Nerve Root Retractors | 701 |
| LOVELACE-DIXON Delicate Haemostatic Forceps | 169 |
| LOVELACE Intestinal and Tissue Grasping Forceps | 387 |
| LOWER Dissecting and Ligature Forceps | 189 |
| Lower Lateral Scissors | 81 |
| Lower Occlusive Clamps, ATRAUMATIC-GRIP | 399 |

LOWMAN-HOGLUND Bone Clamp 630
LOWMAN Bone Clamps 630
LOWMANN-LAMBERT Bone Clamp 630
LUCAE Ear and Nasal Dressing Forceps 136
LUCAE Ear Hooklets 213
LUCAE Mallet 617
LUCAE Tuning Fork 4
LUCAS Bone Curettes 599
LUER-FRIEDMAN Bone Rongeur 631
LUER-KOERTE Gall Stone Scoops 417
LUER-STILLE Bone Rongeurs 634, 636
LUER Bone Rongeurs 631-632
LUER Retractor 227
LUER Trachea Tubes 725
LUIKART-KIELAND Forceps 479
Lumbar Puncture Needles 328
Lumbar Vertebral Column, Retractors 294
Lumbar Vertebral Operations, Specula 295
Lung Dissecting Forceps 149
Lung Retractors 260
Lung Spatulas 260-265
Lupus Curettes 20
Lupus Scraper 19
Luxation Lever 581

M

MAGILL Catheter Introducing Forceps 32
Magnifying Glass 9
MAIER-SIMS Sponge and Dressing Forceps 205
MAIER Sponge and Dressing Forceps 205
Mallets 617-621
MALTZ Rasp 593
MALTZ TITE GRIP Rasps 596
MARBACH Perineum (Episiotomy) Scissors 107
MARBERGER (GIL-VERNET) Vein and Hilar Retractors 223
Marking and Writing Pencils and Marking Apparatus 757
MARKS ST. Pelvis Retractors 258
MARKWALDER Rib Rongeur 494
MARQUARDT Bone Rongeur 634
MARTIN Meniscus and Cartilage Grasping Forceps 640
MARTIN Pelvimeter 477
MARTIN Retractor for Deep Surgery 254
MARTIN ST. Delicate Tissue Forceps 139
MARTINI Bone Curettes 598
MASSON-JUDD Bladder Retractor 310
MASSON Needle Holders 368
MASSON TITE GRIP Needle Holder 347
MASTIN Muscular Clamp 728
MATHIEU-LAWTON TITE GRIP Needle Holder 349
MATHIEU Needle Holders 371
MATHIEU Rectal Speculum 405
MATHIEU Retractors 226, 231
MATHIEU TITE GRIP Needle Holders 349
MATHIEU Vaginal Specula and Retractors 439
MATSON Rib Raspatories 497
MATZENAUER Vaginal Specula 440
MAUNDER Oral Screw 22
MAYFIELD Bone Rongeur 633
MAYO-ADAMS Appendectomy Retractors 284
MAYO-BLAKE Gall Stone Forceps 418
MAYO-HARRINGTON Dissecting Scissors 86
MAYO-HEGAR Needle Holders 367
MAYO-HEGAR TITE GRIP Needle Holders 345
MAYO-HEGAR TITE GRIP Needle Holders for Left-Hander 341
MAYO-LEXER Dissecting Scissors 87
MAYO-LEXER DURACUT Dissecting Scissors 48
MAYO-NOBLE Dissecting Scissors 86
MAYO-ROBSON ATRAUMATIC-GRIP Intestinal Clamp Forceps 396
MAYO-ROBSON Intestinal Clamp Forceps 396
MAYO-STILLE Dissecting Scissors 85
MAYO-STILLE DURACUT Dissecting Scissors 48
MAYO Abdominal Retractor 249
MAYO Dissecting Scissors 84
MAYO DURACUT Dissecting Scissors 47
MAYO Gall Stone Scoop 417
MAYO Safety Pins 736
MAYO Tongue Depressor 12

MAYO Vascular and Tumor Forceps 149
MC DONALD Dissector 574
MC GIVNEY Haemorrhoidal Forceps 410
MC INDOE Bone Cutting Forceps 638
MC INDOE Cartilage Scissors 82
MC INDOE Delicate Dissecting Forceps 130
MC INDOE TITE GRIP Dissecting Forceps 113
MC INTOSH Laryngoscopes 24-27
MC KENTY Raspatory 582
MC KENZIE Burr 652
MC KENZIE Clip Applying Forceps 690
MC KENZIE Silver Brain Clips 690
MC KENZIE Silver Clip Carrier 690
MC KENZIE Silver Wire 690
MC PHERSON Micro Suture Tying Forceps 122
MEAD Bone Rongeurs 631
MEAD Mallet 618
Measuring & Examination Instruments 6
Measuring Instruments 7
Measuring Instruments for Laser Surgery 448
Measuring Jugs 751
Measuring Probe for Laser Surgery 450
Meatotome 426
Medicine Cup 751
Medicine Spoon 751
MEEKER-BABY Dissecting and Ligature Forceps 180
MEEKER Dissecting and Ligature Forceps 187
Membrane Puncturing Forceps 477
MENGHINI Liver Blind Puncture Needles 329
MENGHINI Needles for Controlled Liver Puncture 329
Meniscus and Cartilage Grasping Forceps 640
Meniscus Knives 642-643
MERCEDES Thoracic Retractor 507
Metal Catheters 424
Metal Handles for Laryngeal Mirrors 13
METZENBAUM-BABY Dissecting Scissors 89
METZENBAUM-NELSON Dissecting Scissors 91
METZENBAUM-NELSON DURACUT Dissecting Scissors 53
METZENBAUM-THOREK DURACUT Adnex Scissors 54
METZENBAUM Dissecting Scissors 88-90
METZENBAUM DURACUT Dissecting Scissors 49-52, 54
MEYERDING Laminectomy Retractors 284
MEYERDING Retractors 225
MICHEL Clip Applying and Removing Forceps 379
MICHEL Clip Applying Forceps 379
MICHEL Rhinoscopic Mirrors 14
MICHEL Suture Clips 379
MICRO-ADSON Delicate Dissecting Forceps 129
MICRO-ADSON Delicate Tissue Forceps 140-141
MICRO-ADSON TITE GRIP Tissue Forceps 117
MICRO-CASTROVIEJO Micro Needle Holders 358
MICRO-CRILE Delicate Haemostatic Forceps 166
MICRO-HALSTED Delicate Haemostatic Forceps 164
Micro Blades for Bloodletting 473
Micro Bloodletting and Amnioscopy Instruments 472-473
Micro Bulldog Clamps 162
Micro Dissecting Scissors 65, 67
Micro Forceps 120-125
Micro Forceps (Jeweler Patterns) 120
Micro Forceps, TITE GRIP 118
Micro Grasping Forceps 124
Micro Grasping Forceps, PERFECT GRIP 124
Micro Instruments 694-697
Micro Needle Holders 358-362
Micro Needle Holders, PERFECT GRIP 359, 361-362
Micro Needle Holders, TITE GRIP 338-339
Micro Scissors 62-67
Micro Suction Tubes 321
Micro Suture Tying Forceps 121-123
Micro Suture Tying Forceps, PERFECT GRIP 123
Microscopic Forceps 121
MIDDELDORF Retractors 243
MIKULICZ-BABY Peritoneum Forceps 192
MIKULICZ Liver Retractors 255
MIKULICZ Peritoneum Forceps 192-193
MIKULICZ Retractors for Deep Surgery 255
MILAN Endocervical Biopsy Curettes 460
MILLER-SENN Retractors 226
MILLER Laryngoscopes 28-31

- MILLER** Rasps 592
MILLER TITE GRIP Rasps 596
MILLES Micro Scissors 64
MILLIGAN Dura Separator 698
MILLIN-YOUNG Boomerang Needle Holder 372
MILLIN Bladder Neck Spreader 423
MILLIN Bladder Retractors 310
MILLIN Capsule Forceps 423
MILLIN Ligature Carrying Forceps 423
MILLIN Prostatic Lobe Holding Forceps 423
MINI-HOHMANN Bone Levers 576
MINI-KERN Bone Holding Forceps 625
MINI-LAMBOTTE Osteotomes 608
MINI-LANGENBECK Retractors 224
MINI-LEXER Osteotomes 612
MINI-STILLE Plaster-of-Paris Shears 677
Mini-Transformer 11
MINI-YASARGIL Applying Forceps for Vessel Clips 154
MINI-YASARGIL Vessel Clips 154
MIOTTI-OVERHOLT Dissecting and Ligature Forceps 185
Mirrors 11, 13-14
Mirrors, Head 10
Mirrors, Laryngeal 13-14
Mirrors, Rhinoscopic 14
MIXTER-BABY Dissecting and Ligature Forceps 180
MIXTER-GEMINI Dissecting and Ligature Forceps 181
MIXTER-O'SHAUGNESSY Dissecting and Ligature Forceps 182
MIXTER-OVERHOLT Dissecting and Ligature Forceps 183
MIXTER-PAUL (HEISS) Dissecting and Ligature Forceps 182
MIXTER Dissecting and Ligature Forceps 182, 188-189
MIXTER Gall Stone Forceps 419
MIXTER Surgical Scissors 79
MOBERG Retractors 224
MOD. BONN Delicate Tissue Forceps 138
MOD. ENGL. Towel Clamps 200
MOD. KÖLN Scalp Hemostasis Clips 691
MOD. MÜNCHEN Endometrial Biopsy Curette 459
MOD. SWITZERLAND Micro Forceps (Jeweler Patterns) 120
MOD. TÜBINGEN VANNAS Micro Scissors 62
MOD. USA Bone Curettes 601
MOD. USA Dissecting Forceps 133
MOD. USA Plaster Spreader 682
MOD. USA Tissue Forceps 145
MOD. USA Umbilical Cord Scissors 108
MOD. WIENER Suture Catcher 378
MODELL CANAD. Meniscus Knives 643
MODELL RUSS. Vascular and Tumor Forceps 149
MOGEN Circumcision Clamp 426
MOLDESTAD Vein Retractor 217
MÖLTGEN Goniometer 7
MOORE-STAUDE Uterine Tenaculum Forceps 452
MOORE Gall Bladder Scoop 417
MORGAN-TISCHLER Cervical Biopsy and Specimen Forceps 464
MORRIS-DE BAKEY ATRAUMATIC-GRIP Aortic Clamps 540
MORSE Sternotomy Spreaders 499
MOSQUITO-BABY (HARTMANN) Delicate Haemostatic Forceps 164
MOSQUITO-HALSTED-DE BAKEY ATRAUMATIC-GRIP Delicate Haemostatic Forceps 165
MOSQUITO-HALSTED (HEISS) Delicate Haemostatic Forceps 170
MOSQUITO-HALSTED Delicate Haemostatic Forceps 164-165
MOSQUITO-HALSTED TITAN LINE Delicate Haemostatic Forceps 164
MOTT-PARKER Retractors 228
Mounting Frame for Abdominal Retractors 309
Mouth Gags 22
MOYNIHAN Gall Stone Probe 415
MOYNIHAN Haemostatic Forceps 178
MÜHLING (KILLIAN) Septum Scissors 102
MÜHLING Raspatories 584
MÜLLER-BIEMER Approximators 157
MÜLLER-VERBRUGGE Bone Levers 579
MÜLLER Approximators 158
Multi Purpose Clamps, ATRAUMATIC-GRIP 520-523, 530, 553-554, 556, 562
MUMMERY-LOCKHART Fistula Probe 314
MÜNCHEN MOD. Endometrial Biopsy Curette 459
MURLESS Head Extractor 481
MURPHY-LANE Luxation Lever 581
MURPHY Head Band 10
MURRAY-CRILE Needle Holders 366
Muscular Clamp 728
MUSEUX Uterine Tenaculum Forceps 456
MYERS Vein Strippers 315
Myoma Screws 458
Myrtle Leaf Probes 313
- ## N
- NABATOFF** Vein Strippers 315
NAEGELE Forceps 478
NAGEL Micro Scissors 67
Nail Extracting Forceps 645
Nail Files 18
Nail Nippers 17
Nail Scissors 16
Nail Splitter Forceps 17
Nail Splitting Forceps 645
Nail Splitting Scissors 81
Nailbrush 752
Nasal Dressing Forceps 136-137
Nasal Scissors 101-102
Nasal Scissors, DURACUT 58
Nasal Suction Tubes 324
Needle Guide, Trumpet 486
Needle Holders 363-371
Needle Holders with Scissors 370
Needle Holders, Boomerang 372
Needle Holders, Micro 358-362
Needle Holders, PERFECT GRIP 364
Needle Holders, PERFECT GRIP, Micro 359, 361-362
Needle Holders, PERFECT GRIP, TITAN LINE 365
Needle Holders, TITAN LINE, PERFECT GRIP 365
Needle Holders, TITE GRIP 340-350
Needle Holders, TITE GRIP, for Left-Hander 341
Needle Holders, TITE GRIP, Micro 338-339
Needle Sterilizing Boxes 357
Needlepulling Tissue Forceps, TITE GRIP 116
Needles, Antrum Trocar 319
Needles, Biopsy 329, 518
Needles, Controlled Liver Puncture 329
Needles, Eye 354
Needles, Guide 334
Needles, Injection 486
Needles, Intestinal 354
Needles, Ligature 374-376
Needles, Liver Blind Puncture 329
Needles, Lumbar Puncture 328
Needles, Pleura Puncture 329, 518
Needles, Pneumoperitoneum 329
Needles, REVERDIN 373
Needles, Septum 328
Needles, Special 328
Needles, Sternum Puncture 329, 518
Needles, Surgical, Suture 354-356
Needles, Suture Sterilizing Rack 736
Needles, Tonsil 328
Needles, Vascular Suture 354
NEFF Meniscus Knives 642
NEGUS Haemostatic and Tonsil Forceps 179
NEIVERT-COTTLE Hook for Posterior Nares 221
NEIVERT Needle Holder 363
NEIVERT TITE GRIP Needle Holder 342
NELATON Director 314
NELSON-METZENBAUM Dissecting Scissors 91
NELSON-METZENBAUM DURACUT Dissecting Scissors 53
NELSON Tissue Forceps 148
NELSON Trocars 318
Nerve Dissecting Scissors 93
Nerve Hooks 213-215
Nerve Root Retractors 701
Neurosurgical Scissors 100
NEW ORLEANS Needle Holders 367
NEW ORLEANS TITE GRIP Needle Holder 344
NEWS Trachea Retractor 217
NOBLE-MAYO Dissecting Scissors 86
NORTHBENT (SPENCER) Ligature Scissors 352
NOTO Polypus and Ovum Forceps 457
NOTT Vaginal Specula 433

NOVAK Endometrical Suction Biopsy Curette 459
Nurses, Set for 18
Nursing Articles 751

O

O'BRIEN Ligature Scissors 352
Obstetric Instruments 481, 486
Obstetric Lever 481
Obturator 721
OBWEGESER Soft Tissue Retractors 241
OBWEGESER TITE GRIP Suture Tying Forceps 113
OCHSNER-ALLIS Intestinal and Tissue Grasping Forceps 383
OCHSNER-DIXON (CRILE-RANKIN) Delicate Haemostatic Forceps 167
OCHSNER-KOCHER Haemostatic Forceps 177
OCHSNER-ROCHESTER Haemostatic Forceps 178
OCHSNER ATRAUMATIC-GRIP Aortic Clamps 539
OCHSNER Gall Bladder Trocars 318
OCHSNER Gall Duct Probe 415
OCHSNER Ligature Forceps 152
O'CONNOR-O'SULLIVAN Abdominal Retractor 304
O'CONNOR Skin Retractor 217
OEHLER TITE GRIP Tissue Forceps 118
OLDBERG Pituitary Rongeur 719
OLIVECRONA-TOENNIS (SCOVILLE) Clip Applying Forceps 690
OLIVECRONA (GIGLI) Wire Saws 687
OLIVECRONA Brain Spatulas 706
OLIVECRONA Dura Dissectors 700
OLIVECRONA Trigeminal Scissors 100
OLLIER Retractor 236
OLSEN-HEGAR-BABY TITE GRIP Needle Holder 348
OLSEN-HEGAR Needle Holders with Scissors 370
OLSEN-HEGAR TITE GRIP Needle Holders 348
OMBREDANNE Mallet 621
Operating Scissors 80
Oral Screw 22
Oscillating Plaster Saw 680-681
O'SHAUGNESSY-MIXTER Dissecting and Ligature Forceps 182
Osteotome Blades, Interchangeable 611
Osteotomes 607-613
O'SULLIVAN-O'CONNOR Abdominal Retractor 304
OVERHOLT-BABY Dissecting and Ligature Forceps 183
OVERHOLT-GEISSENDOERFER Dissecting and Ligature Forceps 184
OVERHOLT-MIOTTI Dissecting and Ligature Forceps 185
OVERHOLT-MIXTER Dissecting and Ligature Forceps 183
OVERHOLT Dissecting and Ligature Forceps 183, 185
Ovum and Placenta Curettes 484
Ovum and Placenta Forceps 482-483
Ovum and Placenta Scoops 484
Ovum and Polypus Forceps 457

P

PACIFIC-KEVOURKIAN Cervical Biopsy and Specimen Forceps 464
Pan, Bed 750
Parametrium Forceps 197
Parametrium Scissors, DURACUT 60
PARK-ALAN Rectal Retractor 408
PARKER-LANGENBECK (US-ARMY) Retractors 231
PARKER-MOTT Retractors 228
PARKER Retractors 228
PASQUE EUFRATE TITE GRIP Needle Holders 344
Patella Forceps 623
Patent Ductus Clamps, ATRAUMATIC-GRIP 531, 556
PAUFIQUE Delicate Tissue Forceps 139
PAUL-MIXTER (HEISS) Dissecting and Ligature Forceps 182
PAUL Tendon Sheath Retractor 225
PAYR-BABY Intestinal and Stomach Clamp 403
PAYR Intestinal and Stomach Clamp 403
PAYR Ligature Conductors 377
PAYR Vascular Suture Needles 354
PEAN-DE BAKEY ATRAUMATIC-GRIP Haemostatic Forceps 176
PEAN-DE BAKEY ATRAUMATIC-GRIP Vascular Clamps 529
PEAN-ROCHESTER Haemostatic Forceps 175
PEAN (DIXON) Haemostatic Forceps 174
PEAN Haemostatic Forceps 173-174
PEDERSON Vaginal Specula 432-433

PEERS Towel Clamps 202
PEET Splinter Forceps 151
PEET TITE GRIP Splinter Forceps 151
PELTESON Cotton Applicators 317
Pelvimeter 477
Pelvis Retractors 256-258
Pencils and Apparatus for Marking and Writing 757
PENFIELD Dura Dissectors 699
Penis Clamps 426
PENNINGTON Intestinal and Tissue Grasping Forceps 387
Percussion Hammers 2-3
PERCY Amputation Retractors 571
PERFECT GRIP Micro Grasping Forceps 124
PERFECT GRIP Micro Needle Holders 359, 361-362
PERFECT GRIP Micro Suture Tying Forceps 123
PERFECT GRIP Needle Holders 364
PERFECT GRIP TITAN LINE Needle Holders 365
Perforator 485
Perineum Scissors 107
Perineum Scissors, DURACUT 60
Periosteum Knife 39
Peripheral Vascular Clamps, ATRAUMATIC-GRIP 534-536, 558
Peritoneum Forceps 192-193
PERMAN Abdominal Retractor 299
PERTHES Reamers 650
PETZ VON Stomach and Intestinal Suturing Apparatus 404
Phalangeal Knife 39
PHANEUF Hysterectomy Forceps 194
Pick-Up Forceps 735
Picks, Double 212
PIERCE Antrum Trocar 319
PIFFARD Lupus Curettes 20
PINARD Stethoscope 5
Pins 654
Pins, Conisation 447
Pins, Safety for Holding Ring Handle Instruments 736
PIPER Forceps 480
Pistol, Water Jet with Several Tips 754-755
Pituitary Instruments 692-693
Pituitary Rongeurs 719
Placenta and Ovum Curettes 484
Placenta and Ovum Forceps 482-483
Placenta and Ovum Scoops 484
Plaster-of-Paris Shears 675-678
Plaster-of-Paris Shears, DURACUT 676
Plaster Breakers 682
Plaster Knives 679
Plaster Saw 679
Plaster Saw, Oscillating 680-681
Plaster Spreaders 682
Plastic Surgery Hook 217-218, 226
Plastic Surgery Scissors 70, 82
Plastic Surgery Scissors, DURACUT 45
PLESTER Self-Retaining Retractors 275
Pleura Puncture Needle 518
Pneumoperitoneum Needles 329
Polypus and Ovum Forceps 457
POOLE Suction Tubes 325
Post Mortem Knives 40
POTTS-DE BAKEY ATRAUMATIC-GRIP Patent Ductus Clamps 531
POTTS-SMITH Delicate Dissecting Forceps 131
POTTS-SMITH Delicate Tissue Forceps 143
POTTS-SMITH Dissecting Scissors 98
POTTS-SMITH DURACUT Vascular Scissors 56
POTTS-SMITH TITE GRIP Dissecting Forceps 114
POTTS-SMITH Vascular Scissors 96-97
POZZI Uterine Tenaculum Forceps 453
PRATT Fistula Probes (Crypt Hooks) 409
PRATT Rectal Speculum 405
PRATT Uterine Tenaculum Forceps 455
PREP LUBE Instrument Care Lubricant 733
PRESBYTERIAN Tubing Clamp 203
Pressure Clamp 409
PRICE-THOMAS Bronchus Forceps 566
Probes 312-314
Probes with eye 313
Probes, Buttoned 312-313, 694
Probes, Fistula 314, 409
Probes, Gall Duct 415

| | |
|---|---------|
| Probes, Gall Stone | 415 |
| Probes, Lachrymal | 312 |
| Probes, Laser Surgery | 450-451 |
| Probes, Measuring, for Laser Surgery | 450 |
| Probes, Myrtle Leaf | 313 |
| Probes, Rectal | 409 |
| Probes, Twin | 694 |
| Probes, Uterine | 446 |
| Profunda Clamps, ATRAUMATIC GRIP | 534 |
| Prostatectomy Instruments | 423 |
| Prostatic Lobe Holding Forceps | 423 |
| Prostatic Retractors | 422 |
| PROVIDENCE-HOSPITAL Delicate Haemostatic Forceps | 168 |
| Punches, Dermal | 20 |
| Punches, Laminectomy | 707-712 |
| Pusher, Suture | 694 |
| PUTTI Rasps | 594 |
| PVC-Tubing for Micro-Bloodletting | 473 |
| Pylorus Spreader | 403 |
| PYNCHON-ANDREW Suction Tube | 325 |

Q

| | |
|---------------------------------------|-----|
| QUERVAIN Elevator | 575 |
| QUINBY Gum Scissors | 94 |
| QUINKE Lumbar Puncture Needles | 328 |

R

| | |
|---|----------------------------|
| RABINER Percussion Hammer | 3 |
| Racks, Lable | 743 |
| Racks, Safety for Holding Ring Handle Instruments | 736 |
| Racks, Sterilizing | 736-737 |
| Racks, Sterilizing for Suture Needles | 736 |
| RADOLF Nail Extracting Forceps | 645 |
| RAGNELL-DAVIS Hook for Plastic Surgery | 226 |
| RAGNELL DURACUT Dissecting Scissors | 49 |
| RAGNELL Surgical and Dissecting Scissors | 83 |
| RALK Hand Drill | 653 |
| RALKS (VIRTUS) Splinter Forceps | 151 |
| RAMPLEY Dressing and Sponge Holding Forceps | 210 |
| RANDALL Endometrial Suction Biopsy Curette | 459 |
| RANDALL Kidney Stone Forceps | 420-421 |
| RANEY Applying and Removing Forceps | 691 |
| RANEY Scalp Hemostasis Clip Carrier | 691 |
| RANEY Scalp Hemostasis Clips | 691 |
| RANKIN-CRILE-DE BAKEY ATRAUMATIC-GRIP Delicate Haemostatic Forceps | 167 |
| RANKIN-CRILE (OCHSNER-DIXON) Delicate Haemostatic Forceps | 167 |
| RANKIN-CRILE Delicate Haemostatic Forceps | 167 |
| RANKIN-KELLY Delicate Haemostatic Forceps | 169 |
| Raspatories | 582-591, 694-697 |
| Raspatories, Rib | 495-497 |
| Rasps | 592-595 |
| Rasps, TITE GRIP | 596-597 |
| RAY Curettes | 692 |
| Razor Blade Holders and Breakers | 36 |
| Reamers | 650 |
| RECAMIER Placenta and Ovum Curettes | 484 |
| RECAMIER Uterine Curettes | 468 |
| Rectal Biopsy Specimen Forceps | 412 |
| Rectal Probes | 409 |
| Rectal Retractor | 407-408 |
| Rectal Scissors | 99 |
| Rectal Scissors, DURACUT | 59 |
| Rectal Specula | 405-406 |
| REDO Intestinal Clamp Forceps | 390 |
| REDON Guide Needles | 334 |
| REINER Plaster Knife | 679 |
| Removing and Applying Forceps for Bulldog Clamps | 160, 527 |
| Removing and Applying Forceps for Scalp Hemostasis Clips | 691 |
| Renal Artery Clamp, ATRAUMATIC-GRIP | 537, 558 |
| Reposition Forceps | 622-623 |
| RESANO ATRAUMATIC-GRIP Sigmoid Anastomosis Forceps | 400-401 |
| Resection and Amputation Saws | 572-573 |
| Resection Knives | 38-39 |
| Retractors | 212, 216-251, 261-265, 721 |

| | |
|---|------------------------|
| Retractors, Abdominal | 248-249, 297-309 |
| Retractors, Amputation | 571 |
| Retractors, Appendectomy | 284 |
| Retractors, Atrium | 509 |
| Retractors, Bladder | 310 |
| Retractors, Bone | 232 |
| Retractors, Cervical Spine | 285 |
| Retractors, Cervical Vertebral Column | 290-292 |
| Retractors, Deep Hand and Forearm | 271 |
| Retractors, Deep Surgery | 252-259 |
| Retractors, double-ended | 226-230 |
| Retractors, Dura | 212, 216-217 |
| Retractors, Finger | 271 |
| Retractors, Goitre | 224 |
| Retractors, Hand and Carpal Tunnel | 271 |
| Retractors, Hemi-Laminectomy | 277 |
| Retractors, Hilar | 223 |
| Retractors, Knee | 641 |
| Retractors, Laminectomy | 276, 279-280, 284, 286 |
| Retractors, Liver | 255 |
| Retractors, Lumbar Vertebral Column | 294 |
| Retractors, Lung | 260 |
| Retractors, Micro Surgery | 212 |
| Retractors, Nerve Root | 701 |
| Retractors, Pelvis | 256-258 |
| Retractors, Prostatic | 422 |
| Retractors, Rectal | 407-408 |
| Retractors, Scapula | 260 |
| Retractors, Self-Retaining | 270-285 |
| Retractors, Self-Retaining for Brain | 702-705 |
| Retractors, Self-Retaining for Fixation to Operating Table | 704 |
| Retractors, Self-Retaining for Skull Mounting | 702 |
| Retractors, Skin | 216-218 |
| Retractors, Soft Tissue | 241 |
| Retractors, Spinal | 231 |
| Retractors, Tendon Sheath | 225 |
| Retractors, Thoracic | 507 |
| Retractors, Thyroid Gland | 243 |
| Retractors, Trachea | 217, 219-220, 226 |
| Retractors, Trachea | 728 |
| Retractors, Vaginal | 281 |
| Retractors, Vaginal and Specula | 434-437, 439 |
| Retractors, Vein | 217, 222-223 |
| Retractors, Vertebral Column | 288 |
| REVERDIN Abdominal and Intestinal Spatula | 267 |
| REVERDIN Needles | 373 |
| REYNOLDS-COOLEY ATRAUMATIC-GRIP Anastomosis Clamps | 559 |
| REYNOLDS-DE BAKEY ATRAUMATIC-GRIP Anastomosis Clamps | 542 |
| REYNOLDS Delicate Dissecting Scissors | 93 |
| REZEK-HEANEY Hysterectomy Forceps | 196 |
| Rhinoplastic Knives | 37 |
| Rhinoscopic Mirrors | 14 |
| Rib and Bone Holding Forceps | 493 |
| Rib Contractors | 508 |
| Rib Raspatories | 495-497 |
| Rib Rongeurs | 494 |
| Rib Shears | 492-493 |
| Rib Spreaders | 503-508 |
| Rib Spreaders from ALUMINIUM | 500-502 |
| RICARD Abdominal Retractors | 298 |
| RICHARDSON-EASTMAN Retractors | 250 |
| RICHARDSON Retractors | 251 |
| RICHTER-HEATH Clip Removing Forceps | 379 |
| RICHTER Operating Scissors | 80 |
| RIENHOFF-FINOCHIETTO Rib Spreaders | 506 |
| ROBB Intima Spatulas and Dilators | 512 |
| ROBERTS Haemostatic Forceps | 178 |
| ROBSON-MAYO ATRAUMATIC-GRIP Intestinal Clamp Forceps | 396 |
| ROBSON-MAYO Intestinal Clamp Forceps | 396 |
| ROCHARD Abdominal Retractors | 309 |
| ROCHARD Fixation Device for Abdominal Retractors | 309 |
| ROCHARD Mounting Frame for Abdominal Retractors | 309 |
| ROCHESTER-CARMALT Haemostatic Forceps | 178 |
| ROCHESTER-OCHSNER Haemostatic Forceps | 178 |
| ROCHESTER-PEAN Haemostatic Forceps | 175 |
| ROEDER Towel Clamps | 201 |
| ROGERS (DE BAKEY-HEANY) Hysterectomy Forceps | 197 |
| ROGERS (DE BAKEY-WERTHEIM) Parametrium Forceps | 197 |
| ROGGE Sterilizing Forceps | 734 |

| | |
|---|----------|
| Roller, Tube Milking | 203 |
| ROLLET Retractor | 218 |
| Rongeurs, Bone | 631-636 |
| Rongeurs, Cranial | 688 |
| Rongeurs, Cranial Punch | 688 |
| Rongeurs, Laminectomy | 713-719 |
| Rongeurs, Pituitary | 719 |
| Rongeurs, Rib | 494 |
| ROSCHKE Rectal Retractor | 407 |
| ROSE Retractors | 227 |
| ROSEGER-KLIMA Sternum Puncture Needles | 329, 518 |
| ROSEN Suction Cannulae | 320 |
| ROSER-KÖNIG Mouth Gag | 22 |
| RÖTTGEN-RUSKIN Bone Rongeur | 636 |
| ROUX-BABY Retractors | 228 |
| ROUX Retractors | 229 |
| RUDD Haemorrhoidal Ligator | 410 |
| Ruler | 6 |
| RUMEL-BELMONT Tourniquets | 518 |
| RUMEL-DE BAKEY ATRAUMATIC-GRIP Dissecting and Ligature Forceps | 186 |
| RUMEL Dissecting and Ligature Forceps | 186 |
| RUSKIN-LISTON Bone Cutting Forceps | 638 |
| RUSKIN-RÖTTGEN Bone Rongeur | 636 |
| RUSKIN-STILLE Bone Rongeur | 636 |
| RUSKIN Bone Cutting Forceps | 638 |
| RUSKIN Bone Rongeurs | 633-634 |
| RUSS, MODELL Vascular and Tumor Forceps | 149 |
| RUST Amputation and Resection Saw | 573 |
| RYDEL-SEIFFER Tuning Fork | 4 |
| RYDER-LANGENBECK TITE GRIP Needle Holders | 350 |
| RYDER-VASCULAR TITE GRIP Needle Holders | 340 |
| RYDER TITE GRIP Needle Holders | 340 |

S

| | |
|--|---------|
| SAALFELD Comedo Extractors | 19 |
| SACHS Dura Hook | 217 |
| SACHS Dura Separators | 698 |
| SACHS Fistula Hook | 221 |
| SACHSE Meatotome | 426 |
| SAENGER Placenta and Ovum Forceps | 483 |
| Safety Pins for Holding Ring Handle Instruments | 736 |
| Safety Racks for Holding Ring Handle Instruments | 736 |
| SALENIUS Meniscus Knives | 642 |
| SALING Amnioscopic Tubes | 472 |
| Salpingograph | 474 |
| SAMII-YASARGIL Tumor and Tissue Grasping Forceps | 126 |
| SAMII Tumor and Tissue Grasping Forceps | 127 |
| SANVENERO Plastic Surgery Scissors | 70 |
| SAROT Bronchus Forceps | 566 |
| SAROT Delicate Haemostatic Forceps | 171 |
| SAROT TITE GRIP Needle Holder | 344 |
| SATINSKY-BABY Anastomosis (Vena Cava) Clamp | 565 |
| SATINSKY-DE BAKEY ATRAUMATIC-GRIP Bulldog Clamps | 525 |
| SATINSKY-DE BAKEY ATRAUMATIC-GRIP Tangential Occlusion Clamps | 541 |
| SATINSKY Anastomosis (Vena Cava) Clamps | 565 |
| SATINSKY Vena Cava Scissors | 99 |
| SATTERLEE Amputation and Resection Saws | 572 |
| SAUER Delicate Tissue Forceps | 138 |
| SAUERBRUCH-FREY Rib Shears | 493 |
| SAUERBRUCH-SCHNEIDER Raspatory | 588 |
| SAUERBRUCH Needle Sterilizing Boxes | 357 |
| SAUERBRUCH Pick-Up Forceps | 735 |
| SAUERBRUCH Retractors | 242 |
| SAUERBRUCH Rib Shears | 492 |
| Saws, Amputation and Resection | 572-573 |
| Saws, Finger Ring | 645 |
| Saws, Plaster | 679 |
| Saws, Plaster, Oscillating | 680-681 |
| Saws, Resection and Amputation | 572-573 |
| Saws, Wire | 687 |
| SCALP CONTOUR Self-Retaining Retractors | 276 |
| Scalp Flap Forceps | 481 |
| Scalp Hemostasis Clips | 691 |
| Scalpel Blades, Sterile | 34-35 |
| Scalpel Handles | 34-35 |

| | |
|--|---------------|
| Scapula Retractors | 260 |
| SCHAAF Cilia Forceps | 152 |
| SCHÄDEL Towel Clamps | 200 |
| SCHAMBERG Comedo Extractor | 19 |
| SCHEDE Bone Curettes | 602 |
| SCHERBACK Vaginal Specula | 442 |
| SCHINK Dermatome | 41 |
| SCHMID Intima Spatulas | 513 |
| SCHMID Vascular Irrigation Cannulae | 322 |
| SCHMIEDEN-TAYLOR Dura Scissors | 100 |
| SCHMIEDEN Ligature Conductor | 378 |
| SCHNEIDER-SAUERBRUCH Raspatory | 588 |
| SCHNEIDER Raspatory | 588 |
| SCHNIDT Haemostatic and Tonsil Forceps | 179 |
| SCHOEMAKER-LOTH Ligature Scissors | 352 |
| SCHRÖDER Uterine Scoops | 466 |
| SCHRÖDER Uterine Tenaculum Forceps | 452, 454 |
| SCHUBERT Cervical Biopsy and Specimen Forceps | 461 |
| SCHULTZE Salpingograph | 474 |
| SCHUMACHER Cervical Biopsy and Specimen Forceps | 463 |
| SCHUMACHER Umbilical Cord Scissors | 108 |
| SCHWARTZ Applying Forceps for Vessel Clips | 155 |
| SCHWARTZ Vessel Clips | 155 |
| Scissors, Abdominal | 106 |
| Scissors, Arteriotomy | 95 |
| Scissors, Bandage | 672-674 |
| Scissors, Bandage and Cloth | 674 |
| Scissors, Cartilage | 82 |
| Scissors, Cloth | 674-675 |
| Scissors, Cloth and Bandage | 674 |
| Scissors, Coronary Artery | 95 |
| Scissors, Cuticle | 16 |
| Scissors, Decapitating | 109 |
| Scissors, Dissecting | 81-91, 95, 98 |
| Scissors, Dissecting, Delicate | 92-93 |
| Scissors, Dura | 100 |
| Scissors, DURACUT, Adnex | 54 |
| Scissors, DURACUT, Bandage | 673 |
| Scissors, DURACUT, Delicate | 45 |
| Scissors, DURACUT, Dissecting | 47-54 |
| Scissors, DURACUT, Episiotomy | 60 |
| Scissors, DURACUT, Fistula | 45 |
| Scissors, DURACUT, Gum | 55 |
| Scissors, DURACUT, Gynecological | 60 |
| Scissors, DURACUT, Iris | 45 |
| Scissors, DURACUT, Ligature | 353 |
| Scissors, DURACUT, Nasal | 58 |
| Scissors, DURACUT, Parametrium | 60 |
| Scissors, DURACUT, Perineum | 60 |
| Scissors, DURACUT, Plastic Surgery | 45 |
| Scissors, DURACUT, Rectal | 59 |
| Scissors, DURACUT, Septum | 59 |
| Scissors, DURACUT, Surgical | 46 |
| Scissors, DURACUT, Uterine | 60 |
| Scissors, DURACUT, Vascular | 45, 56-57 |
| Scissors, DURACUT, Wire Cutting | 665 |
| Scissors, Embryotomy | 109 |
| Scissors, Enterotomy | 109 |
| Scissors, Episiotomy | 107 |
| Scissors, Fistula | 80 |
| Scissors, Gum | 94 |
| Scissors, Incision | 80 |
| Scissors, Ligature | 352 |
| Scissors, Lobectomy | 99 |
| Scissors, Lower Lateral | 81 |
| Scissors, Micro | 62-67 |
| Scissors, Micro Dissecting | 65, 67 |
| Scissors, Nail | 16 |
| Scissors, Nail Splitting | 81 |
| Scissors, Nasal | 101-102 |
| Scissors, Nerve Dissecting | 93 |
| Scissors, Neurosurgical | 100 |
| Scissors, Operating | 80 |
| Scissors, Perineum | 107 |
| Scissors, Plastic Surgery | 70, 82 |
| Scissors, Rectal | 99 |
| Scissors, Septum | 102 |
| Scissors, Surgical | 71-83 |
| Scissors, Surgical, Delicate | 68-70 |

- Scissors, Tendon 92
 Scissors, Tonsil 103
 Scissors, Trigeminal 100
 Scissors, Umbilical Cord 108
 Scissors, Uterine 104-106
 Scissors, Vascular 80, 95-98
 Scissors, Vein 63
 Scissors, Vena Cava 99
 Scissors, Wire Cutting 665
 Scoops 695-696
 Scoops, Gall Bladder 417
 Scoops, Gall Stone 417
 Scoops, Ovum and Placenta 484
 Scoops, Placenta and Ovum 484
 Scoops, Uterine 466
SCOVILLE-HAVERFIELD Self-Retaining Retractors 286
SCOVILLE (OLIVECRONA-TOENNIS) Clip Applying Forceps 690
SCOVILLE Hooks for Self-Retaining Retractors 287
SCOVILLE Lateral Valves for Self-Retaining Retractors 287
SCOVILLE Nerve Root Retractors 701
SCOVILLE Self-Retaining Retractors 286
 Scrapers, Lupus 19
 Screws, Myoma 458
 Screws, Oral 22
SCUDDER ATRAUMATIC-GRIP Stomach Clamp Forceps 397
SEALY Delicate Surgical Scissors 68
SEBILEAU Elevator 575
 Secretion Curette 425
SEDILLOT Raspatories 586
SEGD Hysterectomy Forceps 195-196
SEIFFER-RYDEL Tuning Fork 4
SELETZ-GELPI Vaginal Retractors 281
 Self-Retaining Brain Retractors 702-705
 Self-Retaining Retractors 270-285
 Self-Retaining Retractors for Fixation to Operating Table 704
 Self-Retaining Retractors for Skull Mounting 702
SELLHEIM Obstetric Lever 481
SELLORS Rib Spreader 508
SEMB Bone Cutting Forceps 494
SEMB Dissecting and Ligature Forceps 564
SEMB Lung Retractors 260
SEMB Rib and Bone Holding Forceps 493
SEMB Rib Raspatories 496
SEMB Rib Rongeur 494
SEMKEN Delicate Dissecting Forceps 130
SEMKEN Delicate Tissue Forceps 142
SEMKEN TITE GRIP Dissecting Forceps 113
SEMKEN TITE GRIP Tissue Forceps 117
SEMM Abdominal Retractor 305
SEMM Vaginal Specula 432
SENN-GREEN Retractors 224
SENN-MILLER Retractors 226
 Sensibility Instruments 4
 Separators, Dura 698
 Septum Needles 328
 Septum Scissors 102
 Septum Scissors, DURACUT 59
 Sequestrum Forceps 623
 Set for Nurses 18
SEUTIN Cloth Scissors and Plaster-of-Paris Shears 675
SEWALL Raspatory 582
SHAMBAUGH Retractors for Micro Surgery 212
 Shears, DURACUT, Plaster-of-Paris 676
 Shears, Plaster-of-Paris 675-678
 Shears, Rib 492-493
 Side-Arms for **BALFOUR** Abdominal Retractors 303
SIEBOLD-SIMS Uterine Scissors 106
SIEBOLD Uterine Scissors 106
 Sigmoid Anastomosis Forceps 400
 Sigmoid Anastomosis Forceps, ATRAUMATIC-GRIP 400-401
SILVER Dermatome 41
 Silver Wire 690
SIMON-HEANEY Retractor for Deep Surgery 254
SIMON Bone Curettes 605
SIMON Fistula Hook 221
SIMON Retractors for Deep Surgery 254
SIMON Uterine Scoops 466
SIMPSON-BRAUN Forceps 478
SIMPSON Uterine Probes 446
SIMS-MAIER Sponge and Dressing Forceps 205
SIMS-SIEBOLD Uterine Scissors 106
SIMS DURACUT Uterine Scissors 60
SIMS Rectal Specula 405-406
SIMS Uterine Curettes 467
SIMS Uterine Probes 446
SIMS Uterine Scissors 104-105
SIMS Vaginal Specula 438
SINGLEY (TUTTLE) Lung Dissecting Forceps 149
 Sinus Forceps 204
 Skin Retractors 216-218
 Skin Straightening Plate for **SCHINK** Dermatome 41
SMELLIE Perforator 485
SMILLIE Meniscus Knives 643
SMILLIE Retractors for Knee 641
SMITH-BUIE Rectal Retractor 408
SMITH-FERRIS-CUSHING Laminectomy Rongeurs 713
SMITH-FERRIS-KERRISON Laminectomy Punches 709-710, 712
SMITH-FERRIS Tissue Forceps 147
SMITH-HEYWOOD Polypus and Ovum Forceps 457
SMITH-HEYWOOD Tongue Holding Forceps 23
SMITH-POTTS Delicate Dissecting Forceps 131
SMITH-POTTS Delicate Tissue Forceps 143
SMITH-POTTS Dissecting Scissors 98
SMITH-POTTS DURACUT Vascular Scissors 56
SMITH-POTTS TITE GRIP Dissecting Forceps 114
SMITH-POTTS Vascular Scissors 96-97
SMITH Bandage Scissors 672
SOFT-GREGORY ATRAUMATIC-GRIP Carotid Clamps 527
 Soft Tissue Retractors 241
 Solution Bowls 749
SOMER Uterine Elevating Forceps 458
 Spare Blade for **HUMBY** Dermatome 42
 Spare Blade for **SCHINK** Dermatome 41
 Spare Bulbs for Head Lamps 11
 Spatulas, Abdominal 266-267
 Spatulas, Bladder 268
 Spatulas, Brain 706
 Spatulas, Intestinal 266-267
 Spatulas, Intima 512-513
 Spatulas, Intima and Dilators 512
 Spatulas, Lung 260-265
 Speaking Tubes, Valve 726-727
 Special Needles 328
 Specimen and Aspirating Curettes 471
 Specimen and Cervical Biopsy Forceps 460-465
 Specula, Endo- 443
 Specula, Endo- for Lasersurgery 448
 Specula, Lateral for Lasersurgery 448
 Specula, Lumbar Vertebral Operations 295
 Specula, Rectal 405-406
 Specula, Trans-Sphenoidal Hypophysectomy 692
 Specula, Vaginal 430-442
 Specula, Vaginal and Retractors 434-437, 439
SPENCER-WELLS Haemostatic Forceps 173
SPENCER (NORTHBENT) Ligature Scissors 352
SPENCER Ligature Scissors 352
 Sphincteroscopes 407
 Spinal Gouges 616
 Spinal Retractors 231
 Splinter Forceps 150-151
 Splinter Forceps, TITE GRIP 151
 Sponge and Cotton Holder 473
 Sponge and Dressing Forceps 204-207
 Sponge Holding and Dressing Forceps 209-210
 Spongiosa Gouges 615
SPRATT Bone Curettes 602
 Spreaders, Bladder Neck 423
 Spreaders, Lamina 296
 Spreaders, Plaster 682
 Spreaders, Pylorus 403
 Spreaders, Rib 503-508
 Spreaders, Rib, from ALUMINIUM 500-502
 Spring Hooks for Galea Fixation 691
 Spur Crusher 403
SPURLING Laminectomy Rongeurs 717
 Sputum Cup 751
ST. MARKS Pelvis Retractors 258
ST. MARTIN Delicate Tissue Forceps 139

| | |
|--|----------|
| STADLER-BRAUN Perineum (Episiotomy) Scissors | 107 |
| STANDARD-YASARGIL Applying Forceps for Vessel Clips | 154 |
| STANDARD-YASARGIL Vessel Clips | 154 |
| STAUDE-MOORE Uterine Tenaculum Forceps | 452 |
| Steel Rules | 6 |
| Steel Tape Measure | 6 |
| STEINMANN Pins | 654 |
| STEINMANN Tendon Seizing Forceps | 647 |
| STELLBRING Bone Rongeurs | 632 |
| STELZNER (CRAFOORD) Lobectomy and Rectal Scissors | 99 |
| Sterile Scalpel Blades | 34-35 |
| Sterilizing and Storing Cases | 738 |
| Sterilizing Baskets | 745 |
| Sterilizing Boxes | 739-742 |
| Sterilizing Boxes for Needles | 357 |
| Sterilizing Drums | 743 |
| Sterilizing Forceps | 734-735 |
| Sterilizing Rack for Suture Needles | 736 |
| Sterilizing Racks | 736-737 |
| Sterilizing Trays | 744 |
| Sterotomy Spreaders | 499 |
| Sterotomy Spreaders from ALUMINIUM | 498 |
| Sternum Chisel | 492 |
| Sternum Puncture Needles | 329, 518 |
| Stethoscopes | 5 |
| STEVENS Delicate Dissecting and Tendon Scissors | 92 |
| STIEGLITZ (WILLIAMS) Splinter Forceps | 151 |
| STILLE-BARRAYA Vascular and Tumor Forceps | 148 |
| STILLE-CRAFOORD Delicate Haemostatic Forceps | 170 |
| STILLE-DOYEN Retractors | 247 |
| STILLE-GIERTZ Rib Shears | 492 |
| STILLE-LEKSELL Bone Rongeurs | 635 |
| STILLE-LUER Bone Rongeurs | 634, 636 |
| STILLE-MAYO Dissecting Scissors | 85 |
| STILLE-MAYO DURACUT Dissecting Scissors | 48 |
| STILLE-MINI Plaster-of-Paris Shears | 677 |
| STILLE-RUSKIN Bone Rongeur | 636 |
| STILLE-STRANDELL Tendon Sheath Retractor | 225 |
| STILLE Bone Rongeurs | 635 |
| STILLE Chisels | 610 |
| STILLE Gouges | 610 |
| STILLE Hand Bone Drill | 651 |
| STILLE Osteotomes | 610 |
| STILLE Plaster-of-Paris Shears | 677-678 |
| STOCKMANN Penis Clamp | 426 |
| Stomach and Intestinal Clamps | 403 |
| Stomach and Intestinal Suturing Apparatus | 404 |
| Stomach Clamp Forceps, ATRAUMATIC-GRIP | 397 |
| Stopcocks for Syringes | 333 |
| Storing and Sterilizing Cases | 738 |
| Storing Cup | 737 |
| Strabismus Hooks | 213 |
| STRANDELL-STILLE Tendon Sheath Retractor | 225 |
| STRATTE TITE GRIP Needle Holders | 347 |
| STRAUSS Penis Clamp | 426 |
| Strippers, Endarterectomy | 514-515 |
| Strippers, Tendon | 646 |
| Strippers, Vein | 315 |
| STRULLY Neurosurgical Scissors | 100 |
| SUBRAMANIAN ATRAUMATIC-GRIP Aortic Clamps | 537 |
| Suction Adapter | 320 |
| Suction Cannulae | 320-323 |
| Suction Handle | 320 |
| Suction Tubes | 324-327 |
| Suction Tubes, Intracardiac | 327 |
| Suction Tubes, Left Ventricular Sump | 327 |
| Suction Tubes, Micro | 321 |
| Suction Tubes, Nasal | 324 |
| Suction Tubes, Vascular | 327 |
| SULLIVAN (BROPHY) Delicate Dissecting Scissors | 93 |
| SUPER Stethoscope | 5 |
| Surgical Scissors | 71-83 |
| Surgical Scissors, Delicate | 68-70 |
| Surgical Scissors, DURACUT | 46 |
| Surgical Suture Needles | 354-356 |
| Suture Catcher | 378 |
| Suture Clips | 379, 404 |
| Suture Hooks | 518 |
| Suture Instruments | 378 |

| | |
|--|---------|
| Suture Material | 353 |
| Suture Needle Sterilizing Rack | 736 |
| Suture Needles, Surgical | 354-356 |
| Suture Needles, Vascular | 354 |
| Suture Pusher | 694 |
| Suture Silk | 353 |
| Suture Tying Forceps, TITE GRIP | 113 |
| Suturing Apparatus, Intestinal and Stomach | 404 |
| Suturing Instrument Set | 380 |
| SWEET-LAHEY Dissecting and Ligature Forceps | 189 |
| SWITZERLAND MOD. Micro Forceps (Jeweler Patterns) | 120 |
| Syringes | 330-332 |
| Syringes, Connecting Pieces | 333 |
| Syringes, Ear | 332 |
| Syringes, Insuline | 330 |
| Syringes, Stopcocks | 333 |
| Syringes, Tuberkuline | 330 |
| Syringes, Wound and Bladder | 331 |
| SYSTRUNK Nail Splitting Scissors | 81 |

T

| | |
|---|---------------|
| TAKAHASHI Laminectomy Rongeurs | 714 |
| Tampers | 606 |
| Tangential Occlusion Clamps, ATRAUMATIC-GRIP | 541, 562 |
| Tape Measure | 6 |
| TARNIER Forceps | 480 |
| TAYLOR-CUSHING Delicate Dissecting Forceps | 131 |
| TAYLOR-CUSHING Delicate Tissue Forceps | 143 |
| TAYLOR-CUSHING Ear and Nasal Dressing Forceps | 136 |
| TAYLOR-CUSHING TITE GRIP Dissecting Forceps | 114 |
| TAYLOR-SCHMIEDEN Dura Scissors | 100 |
| TAYLOR Lateral Valves for Self-Retaining Retractors | 287 |
| TAYLOR Percussion Hammers | 2 |
| TEALE Uterine Tenaculum Forceps | 456 |
| Tenaculum Forceps, Uterine | 452-456 |
| Tendon Holding Forceps | 648 |
| Tendon Interlacing Forceps | 649 |
| Tendon Passing and Tunneling Instrument | 646 |
| Tendon Passing Forceps | 649 |
| Tendon Passing Instruments | 646 |
| Tendon Scissors | 92 |
| Tendon Seizing Forceps | 647 |
| Tendon Sheath Retractors | 225 |
| Tendon Strippers | 646 |
| Tenotome | 37 |
| THOMAS-PRICE Bronchus Forceps | 566 |
| THOMS-ALLIS Intestinal and Tissue Grasping Forceps | 385 |
| THOMS-GAYLOR Cervical Biopsy and Specimen Forceps | 460 |
| Thoracic and Ligature Forceps | 564 |
| Thoracic Retractor | 507 |
| THOREK-METZENBAUM DURACUT Adnex Scissors | 54 |
| THOREK Dissecting Scissors | 98 |
| THORLAKSON ATRAUMATIC-GRIP Lower Occlusive Clamps | 399 |
| THORLAKSON ATRAUMATIC-GRIP Upper Occlusive Clamp | 398 |
| THORLAKSON Pelvis Retractors | 256-257 |
| THORLAKSON Retractors | 230, 256 |
| Thyroid Gland Retractor | 243 |
| TISCHLER-BABY Cervical Biopsy and Specimen Forceps | 464 |
| TISCHLER-MORGAN Cervical Biopsy and Specimen Forceps | 464 |
| TISCHLER Cervical Biopsy and Specimen Forceps | 465 |
| Tissue and Intestinal Grasping Forceps | 383-388 |
| Tissue and Intestinal Grasping Forceps, ATRAUMATIC-GRIP | 389 |
| Tissue and Intestinal Grasping Forceps, TITE GRIP | 388 |
| Tissue Forceps | 144-148 |
| Tissue Forceps, Delicate | 138-143 |
| Tissue Forceps, TITE GRIP | 117 |
| Tissue Grasping Forceps | 126-127 |
| Tissue Seizing Forceps | 148 |
| TITAN LINE Bulldog Clamps | 160-161 |
| TITAN LINE Delicate Haemostatic Forceps | 164, 166, 168 |
| TITAN LINE PERFECT GRIP Needle Holders | 365 |
| TITE GRIP Dissecting Forceps | 113-115 |
| TITE GRIP Intestinal and Tissue Grasping Forceps | 388 |
| TITE GRIP Micro Forceps | 118 |
| TITE GRIP Micro Needle Holders | 338-339 |
| TITE GRIP Needle Holders | 340-350 |
| TITE GRIP Needle Holders for Left-Hander | 341 |

- TITE GRIP Needlepulling Tissue Forceps 116
 TITE GRIP Rasps 596-597
 TITE GRIP Splinter Forceps 151
 TITE GRIP Suture Tying Forceps 113
 TITE GRIP Tissue Forceps 117
 TITE GRIP Wire Holding Forceps 663
 TITE GRIP Wire Twisting Forceps 662
TOENNIS-ADSON Dissecting Scissors 89
TOENNIS-ADSON DURACUT Dissecting Scissors 49
TOENNIS-OLIVECRONA (SCOVILLE) Clip Applying Forceps 690
TOENNIS Dura Dissectors 700
TOENNIS Dura Knives 37
TOENNIS Needle Holders 371
TOENNIS Surgical and Dissecting Scissors 83
TOENNIS TITE GRIP Needle Holders 350
TOHOKU Towel Clamps 202
 Tongue Depressors 12
 Tongue Holding Forceps 23
 Tonsil Forceps 179
 Tonsil Needles 328
 Tonsil Scissors 103
 Tourniquets 518
 Towel and Brush Baskets 753
 Towel Clamps 200-202
TOWNSEND Cervical Biopsy and Specimen Forceps 465
 Trachea Dilators 728
 Trachea Retractors 217, 219-220, 226, 728
 Trachea Tubes 725-727
 Tracheotomy Instruments 728
 Tracheotomy Set 729-730
 Traction Bar for Bone Clamps 630
 Traction Handle for Forceps 479
 Trans-Sphenoidal Hypophysectomy Specula 692
 Transformer 11
 Trays 748
 Trays, Instrument Storing 748
 Trays, Sterilizing 744
TRELAT Raspatory 582
TRELAT Vaginal Specula 431
 Trephines 721
 Trephines, Bone Biopsy 669
 Triangular Basins 750
 Trigeminal Scissors 100
 Trocar Antrum Needles 319
 Trocar Cannula 721
 Trocars 318, 721
 Trocars, Antrum 319-320
 Trocars, Cryothyrotomy 728
 Trocars, Empyema 318
 Trocars, Gall Bladder 318
TROELTSCH (WILDE) Ear and Nasal Dressing Forceps 137
TROELTSCH Ear and Nasal Dressing Forceps 137
TROEMNER Percussion Hammer 3
TROUSSEAU Trachea Dilator 728
TROUTMAN-BARRAQUER Micro Needle Holders 360
TROUTMAN Razor Blade Holder and Breaker 36
 Trumpet Needle Guide 486
TUBBS Aortic Dilator 511
 Tube Milking Roller 203
 Tuberkuline Syringe 330
 Tubes, Amnioscopic 472
 Tubes, Compression 570
 Tubes, Suction 324-327
 Tubes, Trachea 725-727
 Tubes, Tunneling 517
 Tubes, Valve Speaking 726-727
 Tubing Clamps 203
TÜBINGEN MOD. VANNAS Micro Scissors 62
TUFFIER Abdominal and Intestinal Spatula 267
TUFFIER Rib Spreaders 506
 Tumor Forceps 148-149
 Tumor Grasping Forceps 126-127
 Tuning Forks 4
 Tunneling and Tendon Passing Instrument 646
 Tunneling Instruments for Bypass Grafting 517
 Tunneling Set 516
 Tunneling Tubes 517
TUOHY Lumbar Puncture Needles 328
TUTTLE (SINGLEY) Lung Dissecting Forceps 149
 Twin Probe 694
 Twinlenses for **BERGER** Binocular Head Magnifiers 8
 Twist Drill 652
TYRELL (GRAEFE) Skin Retractors 216
- U**
- UCKERMANN** Cotton Applicators 317
UECKERMANN-DENKER Cryothyrotomy Trocars 728
UFFENORDE Bone Curettes 601
ULRICH Bone Holding Forceps 627
ULRICH Fistula Knife 37
ULRICH Sponge and Dressing Forceps 206
 Umbilical Cord Clamps 486
 Umbilical Cord Scissors 108
UNIVERSAL DURACUT Wire Cutting Scissors 665
UNIVERSAL Trocars 318
UNIVERSAL Wire Cutting Scissors 665
UNNA-VIDAL Comedo Extractor 19
UNNA Comedo Extractors 19
 Upper Occlusive Clamp, ATRAUMATIC-GRIP 398
 Urethrography Instrument 426
 Urinary-Genito Instruments 425-426
US-ARMY (PARKER-LANGENBECK) Retractors 231
USA MOD. Bone Curettes 601
USA MOD. Dissecting Forceps 133
USA MOD. Plaster Spreader 682
USA MOD. Tissue Forceps 145
USA MOD. Umbilical Cord Scissors 108
 Uterine Curettes 466-470
 Uterine Depressor 447
 Uterine Dilator 443-445
 Uterine Dressing Forceps 208
 Uterine Elevating Forceps 458
 Uterine Gauze Packer 447
 Uterine Probes 446
 Uterine Scissors 104-106
 Uterine Scissors, DURACUT 60
 Uterine Scoops 466
 Uterine Tenaculum Forceps 452-456
- V**
- V. EICKEN LICHTWITZ** Antrum Trocar Needles 319
 Vaginal Retractors 281
 Vaginal Retractors and Specula 434-437, 439
 Vaginal Specula 430-442
 Vaginal Specula and Retractors 434-437, 439
VALLEIX Uterine Probes 446
 Valve Ejector for **CASPAR** Self-Retaining Retractors 289
 Valve Speaking Tubes 726-727
 Valves for **KIRSCHNER-BALFOUR** Abdominal Retractors 307
 Valves for **KIRSCHNER** Abdominal Retractors 307
 Valves, Blunt for **CASPAR** Self-Retaining Retractors 293
 Valves, Central for **BALFOUR** Abdominal Retractors 303
 Valves, Central for **HORGAN** Abdominal Retractors 303
 Valves, Lateral for **BALFOUR** Abdominal Retractors 303
 Valves, Lateral for **CASPAR** Self-Retaining Retractors 289, 293
 Valves, Medial for **CASPAR** Self-Retaining Retractors 293
VAN BUREN Dilating Bougies 424
VAN BUREN Sequestrum Forceps 623
VAN DOREN Cervical Biopsy and Specimen Forceps 461
VANNAS MOD. TÜBINGEN Micro Scissors 62
VANNAS-YASARGIL Micro Scissors 66
VANNAS Micro Scissors 62-63, 65
VARCO Delicate Haemostatic Forceps 170
VASCULAR-RYDER TITE GRIP Needle Holders 340
 Vascular Clamps, ATRAUMATIC-GRIP 520-523, 529-530, 534, 537, 555, 558, 561-562
 Vascular Clamps, Semi-Flexible 563
 Vascular Dilators 510
 Vascular Forceps 148-149
 Vascular Forceps, ATRAUMATIC-GRIP 135
 Vascular Irrigation Cannulae 322
VASCULAR PERFECT GRIP Needle Holders 364
 Vascular Scissors 80, 95-98
 Vascular Scissors, DURACUT 45, 56-57

| | |
|---|---------------|
| Vascular Suction Tube | 327 |
| Vascular Suture Needles | 354 |
| VASCULAR TITAN LINE PERFECT GRIP Needle Holders | 365 |
| Vein Retractor | 217, 222-223 |
| Vein Scissors | 63 |
| Vein Strippers | 315 |
| Vena-Cava (Anastomosis) Clamps | 565 |
| Vena-Cava Clamps, ATRAUMATIC-GRIP | 550 |
| Vena Cava Scissors | 99 |
| VERBRUGGE-MÜLLER Bone Levers | 579 |
| VERBRUGGE Bone Holding Forceps | 628 |
| VERESS Pneumoperitoneum Needles | 329 |
| VERNET-GIL (MARBERGER) Vein and Hilar Retractors | 223 |
| Vertebral Biopsy Instruments | 720-721 |
| Vertebral Column Retractors | 288 |
| Vessel Clips | 154-156 |
| Vessel Hooks | 213-215 |
| Vessel Knives | 694-695 |
| VICKERS Deep Hand and Forearm Retractor | 271 |
| VICKERS Finger Retractors | 271 |
| VICKERS Hand and Carpal Tunnel Retractor | 271 |
| VICKERS Handrestrainer | 644 |
| VICKERS Wire Drill Dispenser | 657 |
| VIDAL-UNNA Comedo Extractor | 19 |
| VIDAL Lupus Scraper | 19 |
| VIRCHOW Brain Knives | 40 |
| VIRTUS (RALKS) Splinter Forceps | 151 |
| WISE Micro Suture Tying Forceps | 122 |
| VOGEL Antrum Trocar Needles | 319 |
| VOLKMANN Bone Curettes | 600, 602, 606 |
| VOLKMANN Retractors | 233-234 |
| VOLKMANN Retractors and Bone Retractors | 232 |
| VON PETZ Stomach and Intestinal Suturing Apparatus | 404 |

W

| | |
|---|----------|
| WAGENER Ear Hooklets | 213 |
| WAGNER Bone Lever | 577 |
| WAGNER Mallet | 620 |
| WAGNER Raspatories | 591 |
| WALB Post Mortem Knives | 40 |
| WALDMANN Perineum (Episiotomy) Scissors | 107 |
| WALTON-LISTON (BÖHLER) Bone Cutting Forceps | 638 |
| WANGENSTEEN Needle Holders | 369 |
| WANGENSTEEN TITE GRIP Dissecting Forceps | 115 |
| WANGENSTEEN TITE GRIP Needle Holder | 347 |
| Warm-Light Proximal Illumination for Amnioscopic Tubes | 472 |
| WARTENBERG Algesimeter | 4 |
| Wash Bowls | 749 |
| Water Jet Pistol with Several Tips | 754-755 |
| WATSON-CHEYNE Dissector | 574 |
| WATSON-WILLIAMS Rasp | 593 |
| WAUGH Delicate Dissecting Forceps | 131 |
| WAUGH Delicate Tissue Forceps | 143 |
| WEBER Aesthesiometer | 4 |
| WEBER ATRAUMATIC-GRIP Aorta-Anastomosis Clamps | 548 |
| WEBSTER Needle Holder | 363 |
| WEBSTER TITE GRIP Needle Holder | 342 |
| WEIL-BLAKESLEY Laminectomy Rongeurs | 714 |
| WEISSBARTH Vaginal Speculum | 442 |
| WEITLANER Self-Retaining Retractors | 272-274 |
| WELLS-SPENCER Haemostatic Forceps | 173 |
| WERTHEIM-CULLEN Kidney Pedicle Clamp | 191 |
| WERTHEIM-DE BAKEY (ROGERS) Parametrium Forceps | 197 |
| WERTHEIM (BOZEMANN) TITE GRIP Needle Holders | 346 |
| WERTHEIM Hysterectomy Forceps | 194-195 |
| WERTHEIM Uterine Scissors | 105 |
| WEST Chisels | 607 |
| WEST Gouges | 607 |
| WIENER MOD. Suture Catcher | 378 |
| WIENER Rasps | 593 |
| WILDE (TROELTSCH) Ear and Nasal Dressing Forceps | 137 |
| WILLETT Scalp Flap Forceps | 481 |
| WILLIAMS-WATSON Rasp | 593 |
| WILLIAMS (STIEGLITZ) Splinter Forceps | 151 |
| WILLIAMS Intestinal and Tissue Grasping Forceps | 388 |
| WILLIGER Bone Curettes | 598, 600 |
| WILLIGER Elevators | 574 |

| | |
|--|--------------|
| WILLIGER Mallet | 617 |
| WILLIGER Raspatories | 582 |
| WINTER Placenta and Ovum Forceps | 482 |
| WINTER Stethoscope | 5 |
| Wire Bending and Cutting Pliers | 666 |
| Wire Cutters, DURACUT | 667 |
| Wire Cutting Pliers | 666 |
| Wire Cutting Scissors | 665 |
| Wire Cutting Scissors, DURACUT | 665 |
| Wire Drill Dispenser | 656-657 |
| Wire Drills | 655 |
| Wire Guides | 660-661 |
| Wire Holding Forceps | 663-664 |
| Wire Holding Forceps, TITE GRIP | 663 |
| Wire Saws | 687 |
| Wire Tightener | 660 |
| Wire Traction Bows | 654, 658-659 |
| Wire Twisting Forceps, TITE GRIP | 662 |
| Wires, Bone | 660 |
| Wires, Silver | 690 |
| WITTNER Cervical Biopsy and Specimen Forceps | 462 |
| WOLFF Plaster Breakers | 682 |
| WOLFSON-DE MARTEL Clamp Closing Forceps | 402 |
| WOLFSON-DE MARTEL Clamp Holders | 402 |
| WOLFSON-DE MARTEL Colon-Anastomosis Clamps | 402 |
| WOOD-CRILE Needle Holders | 366, 368 |
| WOOD-CRILE TITE GRIP Needle Holders | 343 |
| WOOD-CRILE TITE GRIP Needle Holders for Left-Hander | 341 |
| Wound and Bladder Syringes | 331 |
| WRIGLEY Forceps | 480 |
| Writing and Marking Pencils and Marking Apparatus | 757 |
| WULLSTEIN Micro Suction Tube | 321 |
| WULLSTEIN Self-Retaining Retractors | 275 |
| WULLSTEIN Suction Cannula | 322 |
| WYLIE ATRAUMATIC-GRIP Aorta-Anastomosis Clamps | 549 |

Y

| | |
|---|----------|
| YANKAUER Suction Tubes | 325-326 |
| YASARGIL-MINI Applying Forceps for Vessel Clips | 154 |
| YASARGIL-MINI Vessel Clips | 154 |
| YASARGIL-SAMIII Tumor and Tissue Grasping Forceps | 126 |
| YASARGIL-STANDARD Applying Forceps for Vessel Clips | 154 |
| YASARGIL-STANDARD Vessel Clips | 154 |
| YASARGIL-VANNAS Micro Scissors | 66 |
| YASARGIL Dissector | 694 |
| YASARGIL Ligature Guides | 697 |
| YASARGIL Micro Dissecting Scissors | 67 |
| YASARGIL Micro Forceps | 125 |
| YASARGIL Micro Scissors | 66 |
| YASARGIL PERFECT GRIP Micro Needle Holders | 362 |
| YASARGIL Pituitary Rongeur | 719 |
| YASARGIL Raspatories | 694-695 |
| YASARGIL Scoop | 695 |
| YASARGIL Spring Hooks for Galea Fixation | 691 |
| YASARGIL Suction Tubes | 324 |
| YASARGIL Tumor and Tissue Grasping Forceps | 126 |
| YASARGIL Vessel Knives | 695 |
| YEOMAN Rectal Biopsy Specimen Forceps | 412 |
| YOUNG-HRYNTSCHAK Boomerang Needle Holder | 372 |
| YOUNG-MILLIN Boomerang Needle Holder | 372 |
| YOUNG Bulbus Hooks | 422 |
| YOUNG Tongue Holding Forceps | 23 |
| YOUNGE-KEVOURKIAN Cervical Biopsy and Specimen Forceps | 463, 465 |
| YOUNGE-KEVOURKIAN Endocervical Biopsy Curettes | 459 |

Z

| | |
|---|-----|
| ZAUFAL-JANSEN Bone Rongeur | 633 |
| ZENKER Dissecting and Ligature Forceps | 188 |
| ZENKER Retractors for Deep Surgery | 259 |
| ZIEGLER Head Band | 10 |
| ZIEGLER Head Mirrors | 10 |
| ZIELKE Gouges for Scoliosis Operations | 614 |
| ZOELLNER Micro Suction Tube | 321 |
| ZWEIFEL TITE GRIP Needle Holder | 349 |

A

ABRAMS Aguja 518
ABRAMS Aguja para la punción de la pleura 329
 Abre-bocas 22
ADAIR Pinza para coger el cuello del útero 452
ADAIR-ALLIS Pinza intestinal y para tejidos 384
ADAMS-MAYO Separadores para apendectomía 284
 Adaptador de tubo para curetas de aspiración 471
ADLERKREUTZ Pinzas para vasos y tumores 148
ADSON Cánulas para aspiración 323
ADSON Ganchos para nervios y vasos 215
ADSON Periostótomos 586
ADSON Pinza-guía para taladros 650
ADSON Pinzas de disección TITE GRIP 113
ADSON Pinzas finas de disección 129
ADSON Pinzas finas quirúrgicas 140-141
ADSON Pinzas hemostáticas finas 169
ADSON Pinzas quirúrgicas TITE GRIP 117
ADSON Porta-agujas 367
ADSON Separadores con retenida automática 273, 278
ADSON Separadores para hemi-laminectomía 277
ADSON Separadores para laminectomía 276, 280
ADSON Taladro espiral 652
ADSON-ANDERSON Separador con retenida automática 276
ADSON-BABY Pinzas de disección y ligaduras 180
ADSON-BECKMANN Separadores para laminectomía 279
ADSON-BROWN Pinza quirúrgica TITE GRIP 117
ADSON-BROWN Pinzas finas quirúrgicas 141
ADSON-MICRO Pinzas finas de disección 129
ADSON-MICRO Pinzas finas quirúrgicas 140-141
ADSON-MICRO Pinzas quirúrgicas TITE GRIP 117
ADSON-TOENNIS Tijeras de disección 89
ADSON-TOENNIS Tijeras DURACUT de disección 49
 Agrafes (Grapas) 379
 Agrafes para suturar de plata alemana 404
 Agujas de biopsia 518
 Agujas de guía 334, 486
 Agujas de repuesto 372
 Agujas de **REVERDIN** 373
 Agujas especiales 328
 Agujas hipodérmica 486
 Agujas **KIRSCHNER** 655
 Agujas para amígdalas 328
 Agujas para biopsia 329
 Agujas para el neumoperitoneo 329
 Agujas para el tabique nasal 328
 Agujas para la punción de la pleura 329
 Agujas para la punción del esternón 329
 Agujas para la punción del hígado 329
 Agujas para ligaduras 374-376
 Agujas para punción lumbar 328
 Agujas para suturas intestinales 354
 Agujas para suturas oculares 354
 Agujas pasa-hilos 660-661
 Agujas quirúrgicas para sutura 354-356
 Agujas vasculares 354
ALAN-PARK Separador para el recto 408
ALDERDYCE Disecador 574
ALDINGER-HOHMANN Elevador para huesos 580
ALEXANDER Cinceles 609
ALEXANDER Gubias 609
ALEXANDER Osteótomos 609
ALEXANDER Pinza saca-bocados para biopsia 463
ALEXANDER-FARABEU Periostótomos costales 497
 Algesímetros 4
 Alicates corta y cierra-alambres 666-668
 Alicates corta-alambres 666-668
 Alicates corta-alambres DURACUT 667
 Alicates de corte frontal y lateral 668
ALLEN Pinzas-clamps intestinales 390
ALLIS ATRAUMATIC-GRIP Pinzas intestinales y para tejidos 389
ALLIS Pinzas intestinales y para tejidos 383-385
ALLIS-ADAIR Pinza intestinal y para tejidos 384
ALLIS-BABY Pinzas intestinales y para tejidos 383
ALLIS-BOYS Pinza intestinal y para tejidos 384
ALLIS-JUDD Pinzas intestinales y para tejidos 384
ALLIS-OCHSNER Pinza intestinal y para tejidos 383

ALLISON Espátula para el pulmón 260
ALLIS-THOMS Pinza intestinal y para tejidos 385
ALM Separadores con retenida automática 270
ALY Algesímetro 4
AMANN Conductor de tapones 447
 Amniótomo 477
 Amputación 570
ANDERSON-ADSON Separador con retenida automática 276
ANDREW-PYNCHON Tubos para aspiración 325
 Anillos de goma para ligadura 410
 Anoscopios 407
 Aparato para marcar y escribir sobre metal 757
 Aparato para suturar estomacal e intestinal 404
 Aproximadores 157-159
 Aproximadores para costillas 508
ARMYTAGE-GREEN Pinza-clamp uterina para hemostasis 481
ARTHUR Pinza para espinas 151
 Artículos para enfermería 751
 Aspiradores micro 321
 ATRAUMATIC GRIP Pinzas vasculares 135
 ATRAUMATIC-GRIP Clamps Bulldog 525-528, 556
 ATRAUMATIC-GRIP Pinza-clamp oclusiva superior 398
 ATRAUMATIC-GRIP Pinza-clamp para arteria renal 537
 ATRAUMATIC-GRIP Pinza-clamp para vasos periféricos 558
 ATRAUMATIC-GRIP Pinzas de disección y ligaduras 186
 ATRAUMATIC-GRIP Pinzas hemostáticas 176
 ATRAUMATIC-GRIP Pinzas hemostáticas finas 165, 167
 ATRAUMATIC-GRIP Pinzas intestinales y para tejidos 389
 ATRAUMATIC-GRIP Pinzas para anastomosis del recto 400-401
 ATRAUMATIC-GRIP Pinzas para disección y ligaduras 551
 ATRAUMATIC-GRIP Pinzas patente de conducto 531, 556
 ATRAUMATIC-GRIP Pinzas-clamps bronquiales 552
 ATRAUMATIC-GRIP Pinzas-clamps de varias aplicaciones 520-523, 530, 553-556
 ATRAUMATIC-GRIP Pinzas-clamps estomacales 397
 ATRAUMATIC-GRIP Pinzas-clamps intestinales 391, 395-396
 ATRAUMATIC-GRIP Pinzas-clamps oclusiva inferior 399
 ATRAUMATIC-GRIP Pinzas-clamps para anastomosis 520-523, 542-544, 548-549, 559-560
 ATRAUMATIC-GRIP Pinzas-clamps para anastomosis de aorta 548-549
 ATRAUMATIC-GRIP Pinzas-clamps para aneurisma de aorta 545-547, 561
 ATRAUMATIC-GRIP Pinzas-clamps para aorta 537-540, 561
 ATRAUMATIC-GRIP Pinzas-clamps para arterias renales 558
 ATRAUMATIC-GRIP Pinzas-clamps para carótida 524, 537
 ATRAUMATIC-GRIP Pinzas-clamps para coarctación 532-533, 557
 ATRAUMATIC-GRIP Pinzas-clamps para histerectomía 197
 ATRAUMATIC-GRIP Pinzas-clamps para iliaca 558
 ATRAUMATIC-GRIP Pinzas-clamps para la profunda 534
 ATRAUMATIC-GRIP Pinzas-clamps para oclusión tangencial 541, 562
 ATRAUMATIC-GRIP Pinzas-clamps para renal 190
 ATRAUMATIC-GRIP Pinzas-clamps para vasos periféricos 534-536
 ATRAUMATIC-GRIP Pinzas-clamps para vena cava 550
 ATRAUMATIC-GRIP Pinzas-clamps vasculares 520-523, 530, 534, 537, 555-556, 558, 561-562
AUFRIEHT Escofina 593
AUFRIEHT Tijeras para la cirugía plástica 82
AUSTIN Micro-pinzas de ligadura 122
AUVARD Espéculos vaginales 441
AUVARD-BERLIND Espéculo vaginal 441

B

BABCOCK ATRAUMATIC-GRIP Pinzas intestinales y para tejidos 389
BABCOCK Pinzas intestinales y para tejidos 385
BABCOCK TITE GRIP Pinzas intestinales y para tejidos 388
BABY-ADSON Pinzas de disección y ligaduras 180
BABY-ALLIS Pinzas intestinales y para tejidos 383
BABY-BAILEY Aproximador para costillas 508
BABY-BALFOUR Separador abdominal 300
BABY-COLLIN Separadores abdominales 297
BABY-CRIE Pinzas hemostáticas finas 166
BABY-DOYEN ATRAUMATIC-GRIP Pinzas-clamps intestinales 391
BABY-DOYEN Pinzas-clamps intestinales 391
BABY-FINOCCHIETTO Separador costal 503
BABY-GELPI Separador para la vulva 281
BABY-GILLIES Porta-agujas con tijera 370
BABY-GILLIES TITE GRIP Porta-agujas 348
BABY-GOSSET Separador abdominal 299

| | |
|--|--------------|
| BABY-HAIGHT-FINOCHIETTO Separador costal | 501 |
| BABY-KELLY Pinzas hemostáticas finas | 168 |
| BABY-KOCHER ATRAUMATIC-GRIP Pinzas-clamps intestinales | 391 |
| BABY-KOCHER Pinzas-clamps intestinales | 391 |
| BABY-LEXER Tijeras de disección | 87 |
| BABY-MEEKER Pinzas de disección y ligaduras | 180 |
| BABY-METZENBAUM Tijeras de disección | 89 |
| BABY-MIKULICZ Pinza-clamp para peritoneo | 192 |
| BABY-MIXTER Pinzas de disección y ligaduras | 180 |
| BABY-MOSQUITO Pinzas hemostáticas finas | 164 |
| BABY-OLSEN-HEGAR TITE GRIP Porta-agujas | 348 |
| BABY-OVERHOLT Pinza de disección y ligaduras | 183 |
| BABY-PAYR Pinzas-clamps intestinales y estomacales | 403 |
| BABY-ROUX Separadores | 228 |
| BABY-SATINSKY Pinza-clamp para anastomosis (vena cava) | 565 |
| BABY-TISCHLER Pinza saca-bocados para biopsia | 464 |
| BACKHAUS Pinzas de campo | 201 |
| BADGLEY Separador para laminectomía | 286 |
| BAHNSON-DE BAKEY ATRAUMATIC-GRIP Pinzas-clamps para aneurisma de aorta | 545 |
| BAILEY (DE MARTEL) Conductor para sierras de hilo | 687 |
| BAILEY Aproximador para costillas | 508 |
| BAILEY ATRAUMATIC-GRIP Pinzas-clamps para aorta | 538 |
| BAILEY-BABY Aproximador para costillas | 508 |
| BAILEY-GIBBON Aproximador para costillas | 508 |
| BAINBRIDGE Pinzas-clamps intestinales | 390 |
| BAINBRIDGE-DE BAKEY ATRAUMATIC-GRIP Pinzas-clamps vasculares | 530 |
| BAKES Dilatadores para el conducto biliar | 416 |
| BALFOUR modif. Separadores abdominales | 302 |
| BALFOUR Separadores abdominales | 300-301, 303 |
| BALFOUR-BABY Separador abdominal | 300 |
| BALFOUR-KIRSCHNER Valvas para separadores abdominales | 307 |
| BALLENGER-FOERSTER Pinzas para torundas y esponjas | 209 |
| BALLENTINE Pinza-clamp para histerectomía | 196 |
| BALLENTINE-HEANEY Pinza-clamp para histerectomía | 196 |
| Bandeja rectangular | 748 |
| Bandejas | 748 |
| Bandejas de esterilización | 744 |
| Bandejas para instrumentos | 748 |
| Bandejas universales | 748 |
| BARNES Cánula para aspiración | 321 |
| BARR Separador para el recto | 408 |
| Barra de tracción para pinzas porta-huesos | 630 |
| BARRAQUER Micro-Porta-agujas | 360 |
| BARRAQUER Pinza depilatoria | 152 |
| BARRAQUER-TROUTMAN Micro-Porta-agujas | 360 |
| BARRAYA-STILLE Pinzas para vasos y tumores | 148 |
| BARRETT Pinza para coger el cuello del útero | 452 |
| BARTH Cucharilla cortante | 599 |
| Bastidores para la fijación a las barras laterales | 309 |
| BAUMGARTNER Porta-agujas | 366 |
| BAUMGARTNER TITE GRIP Porta-agujas | 342 |
| BAUMGARTNER-HEGAR TITE GRIP Porta-agujas | 342 |
| BEACHAM Amniótomo | 477 |
| BECK-COOLEY ATRAUMATIC-GRIP Pinzas-clamps para anastomosis | 560 |
| BECK-DE BAKEY ATRAUMATIC-GRIP Pinza-clamp para aorta | 537 |
| BECK-DE BAKEY ATRAUMATIC-GRIP Pinzas-clamps para anastomosis | 543 |
| BECK-DE BAKEY ATRAUMATIC-GRIP Pinzas-clamps para vena cava | 550 |
| BECKMAN Separador para laminectomía | 280 |
| BECKMANN-ADSON Separadores para laminectomía | 279 |
| BECKMANN-EATON Separador para laminectomía | 280 |
| BEEBEE Cizallas corta-alambres | 665 |
| BEER Pinza depilatoria | 152 |
| BELMONT-RUMEL Torniquetes | 518 |
| BENGOLEA Pinzas hemostáticas finas | 172 |
| BENNETT Elevadores para huesos | 581 |
| BENSON Separador para píloro | 403 |
| BERGER Lupas frontales binoculares | 8 |
| BERGER Pinza saca-bocados para biopsia | 462 |
| BERGMANN Tijera para tela, cizalla para escayolas | 675 |
| BERLIND-AUARD Espéculo vaginal | 441 |
| BERLINER Martillos de percusión | 2 |
| BERMANN Martillos | 621 |
| BERNHARD Pinza de campo | 201 |
| BETHUNE Costótomo | 493 |
| BEYER Pinza cortante para laminectomía | 707 |
| BEYER Pinzas-gubias | 632-633 |

| | |
|--|----------|
| BIEMER Clips vasculares | 156 |
| BIEMER Tijeras para venas | 63 |
| BIEMER-MÜLLER Aproximadores | 157 |
| BIER Sierra para amputación y resección | 573 |
| BILL Tractor | 479 |
| BIRCHER Bisturíes para menisco | 643 |
| BIRCHER-GANSKE Pinzas para menisco y cartilago | 640 |
| Bisturíes para menisco | 642-643 |
| Bisturíes para rinoplastia | 37 |
| BLAKE Cureta uterina | 466 |
| BLAKE Pinzas para los cálculos biliares | 418 |
| BLAKE-MAYO Pinzas para los cálculos biliares | 418 |
| BLAKESLEY-WEIL Pinzas cortantes para laminectomía | 714 |
| BLESSING Tijera DURACUT para la cirugía del recto | 59 |
| BLOUNT Elevadores para caderas | 580 |
| BLOUNT Separadores para rodilla | 641 |
| BLUMENTHAL Pinza-gubia | 631 |
| BLUNT Imperdible para instrumentos | 736 |
| BOETTCHER Tijera para amígdalas | 103 |
| BÖHLER (LISTON-WALTON) Pinzas cortantes para huesos | 638 |
| BÖHLER Estribos para extensión | 654 |
| BÖHLER Pinzas-gubias | 633 |
| Bombilla de repuesto | 472 |
| BONNEY Pinza de disección | 134 |
| BONNEY Pinza de disección TITE GRIP | 115 |
| BONNEY Pinzas quirúrgicas | 147 |
| BONNEY Pinzas quirúrgicas TITE GRIP | 118 |
| BOSE Separadores para la tráquea | 728 |
| BOYS-ALLIS Pinza intestinal y para tejidos | 384 |
| BOZEMANN (WERTHEIM) TITE GRIP Porta-agujas | 346 |
| BOZEMANN Pinzas para tapones | 208 |
| BOZEMANN-DOUGLAS Pinza para tapones | 208 |
| BRAND Pinzas-conductoras de tendón | 648 |
| BRAUN Craneoclasto | 485 |
| BRAUN Depresor uterino | 447 |
| BRAUN Gancho para decapitación | 485 |
| BRAUN Pinza para coger el cuello del útero | 452, 454 |
| BRAUN-SIMPSON Fórceps | 478 |
| BRAUN-STADLER Tijera para perineo (episiotomía) | 107 |
| BRAWLEY Escofina | 593 |
| BREISKY Espéculos vaginales | 438, 440 |
| BRIDGE Pinza de disección y ligaduras | 187 |
| BRINKERHOFF Espéculo para el recto | 406 |
| BROPHY (SULLIVAN) Tijeras finas de disección | 93 |
| BROPHY Pinzas finas de disección | 131 |
| BROPHY Pinzas finas quirúrgicas | 143 |
| BROWN Pinzas agarre de tejidos | 148 |
| BROWN Porta-agujas | 366 |
| BROWN-ADSON Pinza quirúrgica TITE GRIP | 117 |
| BROWN-ADSON Pinzas finas quirúrgicas | 141 |
| BROWNE-DENIS Separador abdominal | 305 |
| BRUENINGS Depresor lingual | 12 |
| BRUNNER Pinza para anastomosis del recto | 400 |
| BRUNNER Separadores para cirugía profunda | 252-253 |
| BRUNS Cizallas para escayolas | 676 |
| BRUNS Cucharillas cortantes | 602-603 |
| BRUNS DURACUT Cizalla para escayolas | 676 |
| BUCHWALD Depresor lingual | 12 |
| BUCK Martillos de percusión | 3 |
| BUCK-GRAMCKO Elevador para huesos | 576 |
| BUELAU Trocar para punción torácica | 318 |
| BUIE Pinza-clamp de presión progresiva | 409 |
| BUIE-SMITH Separador para el recto | 408 |
| Bujías dilatadoras | 424 |
| Bulldog clamps TITAN-LINE | 160-161 |
| Bulldog Micro-Clamps | 162 |
| BUMM Curetas para aborto y placenta | 484 |
| BUMM Curetas uterinas | 470 |
| BUNNELL Conductor de tendones | 646 |
| BUNNELL Mondador de tendones | 646 |
| BUNNELL Perforador de mano | 653 |
| BURFORD-FINOCHIETTO Separadores costales | 502-503 |
| BURKE Pinza saca-bocados para biopsia | 464 |
| BUSH Tijeras umbilicales | 108 |

C

| | |
|-----------------------------------|---------|
| Cajas de esterilización | 738-743 |
|-----------------------------------|---------|

| | | | |
|--|-----------------------|--|----------|
| Cajas para conservación | 738 | CLOWARD Separadores para la columna cervical | 285 |
| Cajas para instrumentos | 746 | COAKLEY Cánula para punción del seno maxilar | 319 |
| Calibrador | 7 | COBB Gubias espinales | 616 |
| CALNE ATRAUMATIC-GRIP Pinza-clamp para vena cava | 550 | COBB Periostótomos | 589, 591 |
| CANAD. MOD. Bisturíes para menisco | 643 | COLCLOUGH (LOVE-KERRISON) Pinzas cortantes para laminectomía | 710-711 |
| CANNON Cuchillo para la íntima | 513 | COLLER-CRILE Pinzas hemostáticas finas | 167 |
| CANNON Espátula para la íntima | 513 | COLLIER Porta-agujas | 363 |
| CANNON Juego para endarterectomía | 515 | COLLIN ATRAUMATIC-GRIP Pinzas intestinales y para tejidos | 389 |
| CANNON Sondas para endarterectomía | 514 | COLLIN Clamp umbilical | 486 |
| Cánulas para aspiración | 320-323 | COLLIN Dinamómetro | 6 |
| Cánulas para irrigación | 322 | COLLIN Espéculos vaginales | 431 |
| Cánulas para irrigación del seno maxilar | 322 | COLLIN Martillo | 617 |
| Cánulas para punción del seno maxilar | 319-320 | COLLIN Pinza intestinal y para tejidos | 386 |
| Cánulas traqueales | 725-727 | COLLIN Pinza para el útero | 458 |
| Cánulas vasculares para irrigación | 322 | COLLIN Pinza para quitar agrafes | 379 |
| CAPLAN Tijera DURACUT para el tabique nasal | 59 | COLLIN Pinza para vendajes y torundas | 207 |
| CARMALT-ROCHESTER Pinzas hemostáticas | 178 | COLLIN Pinza tira-lengua | 23 |
| CAROTIS-DE BAKEY ATRAUMATIC-GRIP Clamp Bulldog | 525 | COLLIN Separadores | 227 |
| CARROLL Pinza-conductora de tendón | 648 | COLLIN Separadores abdominales | 297-298 |
| CARROLL Porta-agujas | 366 | COLLIN-BABY Separadores abdominales | 297 |
| CARROLL TITE GRIP Porta-agujas | 344 | COLLIN-DUVAL Pinza intestinal | 149 |
| CASPAR Espéculos para la cirugía lumbar vertebral | 295 | COLLIN-DUVAL Pinzas intestinales y para tejidos | 386 |
| CASPAR Ganchos para exploración y coagulación | 215 | COLLIN-FARABEUF Periostótomos | 588 |
| CASPAR Periostótomos | 585 | COLLIN-HARTMANN Separador | 229 |
| CASPAR Pinzas cortantes para laminectomía | 718-719 | COLLIN-LANDAU Espéculos vaginales | 431 |
| CASPAR Separador | 245 | Combinación tapa/pinza | 735 |
| CASPAR Separador para la cirugía lumbar vertebral | 294 | Compases | 7 |
| CASPAR Separador para la columna cervical | 290-292 | Compresores uretrales | 426 |
| CASPAR Separador para la columna vertebral | 288 | Conductor de tapones | 447 |
| CASTANEDA ATRAUMATIC-GRIP Pinzas-clamps de varias aplicaciones | 520 | Conductor de tendones | 646 |
| CASTANEDA ATRAUMATIC-GRIP Pinzas-clamps para anastomosis | 520 | Conductor para sierras de hilo | 687 |
| CASTANEDA Separadores costales | 500 | CONE Pinza saca-bocado craneal | 688 |
| CASTROVIEJO Compás | 7 | CONTOUR SCALP Separadores con retenida automática | 276 |
| CASTROVIEJO Pinza para sujetar y romper hojas de afeitar | 36 | CONVERSE (GILLIES) Ganchos para piel y dura-madre | 216 |
| CASTROVIEJO Pinzas finas quirúrgicas | 138 | CONVERSE TITE GRIP Porta-agujas | 342 |
| CASTROVIEJO Porta-agujas | 363 | COOLEY ATRAUMATIC-GRIP Clamps Bulldog | 556 |
| CASTROVIEJO TITE GRIP Micro-Porta-agujas | 338-339 | COOLEY ATRAUMATIC-GRIP Pinzas patente de conducto | 556 |
| CASTROVIEJO-MICRO Micro-Porta-agujas | 358 | COOLEY ATRAUMATIC-GRIP Pinzas-clamps de varias aplicaciones | 562 |
| Catéter de eustaquio | 322 | COOLEY ATRAUMATIC-GRIP Pinzas-clamps para anastomosis | 560 |
| Catgut | 353 | COOLEY ATRAUMATIC-GRIP Pinzas-clamps para aneurisma de aorta | 561 |
| CATLIN Cuchillo para amputación | 38 | COOLEY ATRAUMATIC-GRIP Pinzas-clamps para aorta | 561 |
| Cepillo de uñas | 752 | COOLEY ATRAUMATIC-GRIP Pinzas-clamps para arterias renales | 558 |
| Cepillos de limpieza | 756 | COOLEY ATRAUMATIC-GRIP Pinzas-clamps para coarctación | 557 |
| Cestas de esterilización | 744-745 | COOLEY ATRAUMATIC-GRIP Pinzas-clamps para iliaca | 558 |
| Cestas para cepillos | 753 | COOLEY ATRAUMATIC-GRIP Pinzas-clamps para la pediatría | 555 |
| Cestas para toallas | 753 | COOLEY ATRAUMATIC-GRIP Pinzas-clamps para oclusión tangencial | 562 |
| CHAMPY Trépanos | 669 | COOLEY ATRAUMATIC-GRIP Pinzas-clamps para varias aplicaciones | 556 |
| CHAPUT Pinza intestinal y para tejidos | 383 | COOLEY ATRAUMATIC-GRIP Pinzas-clamps para vasos periféricos | 558 |
| CHARRIÈRE Sierras para amputación y resección | 572-573 | COOLEY Dilatadores de aorta | 511 |
| CHEATTLE Pinzas para esterilización | 734 | COOLEY Dilatadores vasculares | 510 |
| CHERON Pinza para vendajes y torundas | 207 | COOLEY Separadores atrium | 509 |
| CHEVALIER Separador costal | 507 | COOLEY Separadores para esternotomía | 498-499 |
| CHEVALIER-JACKSON Cánula traqueal | 726 | COOLEY Tubo para aspiración | 327 |
| CHEYNE-WATSON Disecador | 574 | COOLEY Tubo para aspiración intracardiaco | 327 |
| CHILDE Pinzas aproximadoras sin porta-clips | 378 | COOLEY Tubo para aspiración vascular | 327 |
| Cilindros | 330-331 | COOLEY-BECK ATRAUMATIC-GRIP Pinzas-clamps para anastomosis | 560 |
| Cinceles | 607, 609-611, 613-614 | COOLEY-DERRA ATRAUMATIC-GRIP Pinzas-clamps para anastomosis | 559 |
| Cinceles para esternón | 492 | COOLEY-REYNOLDS ATRAUMATIC-GRIP Pinzas-clamps para anastomosis | 559 |
| Cinceles, hojas intercambiables | 611 | COOPER Agujas para ligaduras | 374 |
| Cintas | 10 | Copas graduadas | 751 |
| Cintas métricas | 6 | CORWIN-HEGAR TITE-GRIP Pinza cierra-hilos | 662 |
| CITELLI Pinza cortante para laminectomía | 707 | CORYLLOS Separadores y espátulas para el pulmón | 261 |
| Cizallas corta-alambres | 665 | Costótomos | 492-493 |
| Cizallas corta-alambres DURACUT | 665 | COTTLE Escofina | 593 |
| Cizallas para escayolas | 675-678 | COTTLE Gancho para la cirugía plástica | 218 |
| Cizallas para escayolas DURACUT | 676 | COTTLE Gancho para piel y dura-madre | 217 |
| Clamps Bulldog | 160-163 | COTTLE Martillo | 620 |
| Clamps Bulldog ATRAUMATIC-GRIP | 525-528, 556 | COTTLE Osteótomos | 608 |
| Clamps Bulldog TITAN-LINE | 160-161 | COTTLE Periostótomo | 583, 585 |
| Clamps para anastomosis del colon | 402 | COTTLE Tijera nasal | 102 |
| Clamps umbilicales | 486 | COTTLE Tijeras DURACUT nasales | 58 |
| Clamps-Micro Bulldog | 162 | COTTLE-NEIVERT Gancho para las coanas | 221 |
| CLAR Lámpara frontale para corriente de baja tensión | 11 | CRAFOORD (STELZNER) Tijera para lobectomía y recto | 99 |
| Clavija cónica | 447 | CRAFOORD Pinza hemostática fina | 171 |
| Clavos | 654 | CRAFOORD Pinzas para la aurícula atril | 564 |
| CLEVELAND Pinzas cortantes para huesos | 637 | | |
| Clips vasculares | 154-156 | | |
| CLOWARD Separadores para cuerpos vertebrales | 296 | | |

CRAFOORD-DE BAKEY ATRAUMATIC-GRIP Pinzas-clamps para aneurisma de aorta 546

CRAFOORD-STILLE Pinzas hemostáticas finas 170

CRAIG-KOGLER Juego para la biopsia vertebral 720-721

Craneoclasto 485

CRILE Ganchos para nervios y vasos 214

CRILE Pinzas hemostáticas finas TITAN-LINE 166

CRILE Porta-agujas 371

CRILE Separadores 227

CRILE-BABY Pinzas hemostáticas finas 166

CRILE-COLLER Pinzas hemostáticas finas 167

CRILE-MICRO Pinzas hemostáticas finas 166

CRILE-MURRAY Porta-agujas 366

CRILE-RANKIN (OCHSNER-DIXON) Pinzas hemostáticas finas 167

CRILE-RANKIN-DE BAKEY ATRAUMATIC-GRIP Pinzas hemostáticas finas 167

CRILE-WOOD Porta-agujas 366, 368

CRILE-WOOD TITE GRIP Porta-agujas 343

CRILE-WOOD TITE GRIP Porta-agujas para zurdos 341

CRUTCHFIELD Perforadores iniciales 689

CRUTCHFIELD Pinzas de tracción craneal 689

Cubetas 750

Cubetas para soluciones 749

Cubetas triangulares 750

Cuchara graduada 751

Cucharillas cortantes 598-606, 695-696

Cucharillas para aborto 484

Cucharillas para la vesícula biliar 417

Cucharillas para los cálculos biliares 417

Cucharillas para placenta 484

Cucharillas para secreción 425

Cucharillas uterinas 466

Cuchillos interóseos 39

Cuchillos para amputación 38-39

Cuchillos para autopsia 40

Cuchillos para cerebro 40

Cuchillos para dura-madre 37

Cuchillos para escayolas 679

Cuchillos para falanges 39

Cuchillos para la íntima 513

Cuchillos para lóbulos 39

Cuchillos para periostio 39

Cuchillos para resección 38-39

Cuchillos para vasos 694-695

Cuchillos post mortem 40

CULLEN-WERTHEIM Pinza-clamp para pedículo renal 191

Cuñas 750

Curetas 692

Curetas aspiradora para biopsia endo-uterina 459

Curetas de aspiración 471

Curetas de biopsia de aspiración 471

Curetas para aborto 484

Curetas para biopsia 459-460

Curetas para biopsia endo-cerviz 459

Curetas para biopsia endo-uterina 459

Curetas para lupus 20

Curetas para placenta 484

Curetas uterinas 466-470

CURTIS Pinza quirúrgica 147

CUSCO Espéculos vaginales 431

CUSCO Espéculos vaginales para vírgenes 430

CUSHING Espátula cerebral 706

CUSHING Gancho para decompresión 701

CUSHING Gancho para dura-madre 218

CUSHING Ganchos para nervios y vasos 214

CUSHING Pinzas cortantes para laminectomía 715

CUSHING Pinzas de disección TITE GRIP 114

CUSHING Pinzas finas de disección 130

CUSHING Pinzas finas quirúrgicas 142

CUSHING Separadores para venas 222-223

CUSHING Taladro 652

CUSHING-FERRIS-SMITH Pinzas cortantes para laminectomía 713

CUSHING-LANDOLT Espéculos para la hipofisectomía 692

CUSHING-TAYLOR Pinza de disección TITE GRIP 114

CUSHING-TAYLOR Pinza fina de disección 131

CUSHING-TAYLOR Pinza fina quirúrgica 143

CUSHING-TAYLOR Pinzas auriculares y nasales 136

CUZZI Cucharilla para aborto y placenta 484

CZERNY Espéculo para el recto 405

CZERNY Pinza para coger el cuello útero 455

D

DAHLGREN Pinza saca-bocado craneal 688

DALE ATRAUMATIC-GRIP Pinzas-clamps para vasos periféricos 535

DANDY Ganchos para nervios y vasos 214

DANDY Pinzas hemostáticas finas 165

DARDIK ATRAUMATIC-GRIP Pinzas-clamps de varias aplicaciones 554

DARTIGUES Pinza para sostener el riñón 421

DAUBENSPECK Cucharilla cortante 604

DAVIDSON Separadores para scápula 260

DAVIS Espátula cerebral 706

DAVIS-RAGNELL Gancho para cirugía plástica 226

DAY Ganchitos auriculares 213

DE BAKEY (GARRETT) Dilatadores vasculares 510

DE BAKEY ATRAUMATIC-GRIP Clamps Bulldog 526, 528

DE BAKEY ATRAUMATIC-GRIP Pinzas para disección y ligaduras 551

DE BAKEY ATRAUMATIC-GRIP Pinzas patente de conducto 531

DE BAKEY ATRAUMATIC-GRIP Pinzas-clamps de varias aplicaciones 530, 553

DE BAKEY ATRAUMATIC-GRIP Pinzas-clamps para anastomosis 543

DE BAKEY ATRAUMATIC-GRIP Pinzas-clamps para aneurisma de aorta 545, 547

DE BAKEY ATRAUMATIC-GRIP Pinzas-clamps para aorta 539

DE BAKEY ATRAUMATIC-GRIP Pinzas-clamps para arteria renal 537

DE BAKEY ATRAUMATIC-GRIP Pinzas-clamps para coarctación 532-533

DE BAKEY ATRAUMATIC-GRIP Pinzas-clamps para oclusión tangencial 541

DE BAKEY ATRAUMATIC-GRIP Pinzas-clamps para vasos periféricos 535-536

DE BAKEY ATRAUMATIC-GRIP Pinzas-clamps vasculares 529

DE BAKEY ATRAUMATIC GRIP Pinzas vasculares 135

DE BAKEY Pinzas para tejidos y tirar uñas TITE GRIP 116

DE BAKEY Separadores costales 504-505

DE BAKEY Tijera para arteriotomía 95

DE BAKEY Tijeras DURACUT vasculares 57

DE BAKEY Tijeras vasculares 96

DE BAKEY TITE GRIP Porta-agujas 343

DE BAKEY Tubos para aspiración 325

DE BAKEY-BAHNSON ATRAUMATIC-GRIP Pinzas-clamps para aneurisma de aorta 545

DE BAKEY-BAINBRIDGE ATRAUMATIC-GRIP Pinzas-clamps vasculares 530

DE BAKEY-BECK ATRAUMATIC-GRIP Pinza-clamp para aorta 537

DE BAKEY-BECK ATRAUMATIC-GRIP Pinzas-clamps para anastomosis 543

DE BAKEY-BECK ATRAUMATIC-GRIP Pinzas-clamps para vena cava 550

DE BAKEY-CAROTIS ATRAUMATIC-GRIP Clamp Bulldog 525

DE BAKEY-CRAFOORD ATRAUMATIC-GRIP Pinzas-clamps para aneurisma de aorta 546

DE BAKEY-CRILE-RANKIN ATRAUMATIC-GRIP Pinzas hemostáticas finas 167

DE BAKEY-DERRA ATRAUMATIC-GRIP Pinzas-clamps para anastomosis 542

DE BAKEY-DIETRICH ATRAUMATIC-GRIP Clamps Bulldog 526

DE BAKEY-GLOVER ATRAUMATIC-GRIP Clamps Bulldog 525

DE BAKEY-GUYON ATRAUMATIC-GRIP Pinzas-clamps para renal 190

DE BAKEY-HARKEN ATRAUMATIC-GRIP Pinzas para disección y ligaduras 551

DE BAKEY-HEANEY (ROGERS) ATRAUMATIC-GRIP Pinzas-clamps para histerectomía 197

DE BAKEY-MORRIS ATRAUMATIC-GRIP Pinzas-clamps para aorta 540

DE BAKEY-MOSQUITO-HALSTED ATRAUMATIC-GRIP Pinzas hemostáticas finas 165

DE BAKEY-PEAN ATRAUMATIC-GRIP Pinzas-clamps vasculares 529

DE BAKEY-PEAN ATRAUMATIC-GRIP Pinzas hemostáticas 176

DE BAKEY-POTTS ATRAUMATIC-GRIP Pinzas patente de conducto 531

DE BAKEY-REYNOLDS ATRAUMATIC-GRIP Pinzas-clamps para anastomosis 542

DE BAKEY-RUMEL ATRAUMATIC-GRIP Pinzas de disección y ligaduras 186

DE BAKEY-SATINSKY ATRAUMATIC-GRIP Clamps Bulldog 525

DE BAKEY-SATINSKY ATRAUMATIC-GRIP Pinzas-clamps para oclusión tangencial 541

DE BAKEY-WERTHEIM (ROGERS) ATRAUMATIC-GRIP Pinzas-clamps parametrium 197

DE MARTEL (BAILEY) Conductor para sierras de hilo 687

| | |
|--|-----------------------|
| DE MARTEL-WOLFSON Clamps para anastomosis del colón | 402 |
| DE MARTEL-WOLFSON Pinza para cerrar los clamps | 402 |
| DE MARTEL-WOLFSON Porta-clamp | 402 |
| DE VILBISS Espéculo vaginal | 433 |
| DE VILBISS Pinza saca-bocado craneal | 688 |
| DEAN Tijera para amígdalas | 103 |
| DEAN Tijeras DURACUT para encías | 55 |
| DEAVER Separadores y espátulas para el pulmón | 264-265 |
| DEAVER Tijeras para cirugía | 71 |
| DEAVER-FORD Separador y espátula para el pulmón | 263 |
| DEJERINE Martillos de percusión | 2 |
| DEMEL Agujas pasa-hilos | 660 |
| DENHARDT Abre-boca | 22 |
| DENIS-BROWNE Separador abdominal | 305 |
| DENKER-UECKERMANN Trocares traqueales | 728 |
| Deponette | 738 |
| Depresores linguales | 12 |
| Depresores uterinos | 447 |
| DERF Porta-agujas | 363 |
| DERF TITE GRIP Porta-agujas | 342 |
| Dermátomos | 41-42 |
| Dermátomos para hojas de afeitar corrientes | 41 |
| DERRA-COOLEY ATRAUMATIC-GRIP Pinzas-clamps para anastomosis | 559 |
| DERRA-DE BAKEY ATRAUMATIC-GRIP Pinzas-clamps para anastomosis | 542 |
| DESCHAMPS Agujas para ligaduras | 374-376 |
| DESJARDINS Pinzas para los cálculos biliares | 419 |
| DESJARDINS Sonda para el conducto biliar | 415 |
| DESMARRES Separadores para venas (separadores para párpados) | 222 |
| Detergente para instrumentos | 733 |
| DEUCHER Separador abdominal | 299 |
| DEVIN ATRAUMATIC-GRIP Pinzas-clamps para carótida | 524 |
| Diapasónes | 4 |
| DIEFFENBACH Clamps Bulldog | 163 |
| DIETRICH ATRAUMATIC-GRIP Pinza-clamp para aorta | 539 |
| DIETRICH Micro-Clamps Bulldog | 162 |
| DIETRICH Tijera vascular | 97 |
| DIETRICH TITE GRIP Micro-Porta-agujas | 339 |
| DIETRICH-DE BAKEY ATRAUMATIC-GRIP Clamps Bulldog | 526 |
| DIETRICH-HEGEMANN Tijeras DURACUT vasculares | 56 |
| DIETRICH-HEGEMANN Tijeras vasculares | 96 |
| Dilatador para el cuello vesical | 423 |
| Dilatadores de aorta | 511 |
| Dilatadores para el conducto biliar | 416 |
| Dilatadores para la íntima | 512 |
| Dilatadores para la tráquea | 728 |
| Dilatadores uterinos | 443-445 |
| Dilatadores vasculares | 510 |
| Dinamómetros | 6 |
| DINGMANN modif. Pinzas para huesos | 624 |
| DINGMANN Pinzas para huesos | 624 |
| Disecadores | 574, 693-694, 696-697 |
| Disecadores para dura-madre | 698-700 |
| Dispensadores de agujas | 656-657 |
| Distribuidores de cepillos | 752 |
| DITTEL Guía para catéteres (introducción) | 425 |
| DIXON-LOVELACE Pinzas hemostáticas finas | 169 |
| DIXON-OCHSNER (CRILE-RANKIN) Pinzas hemostáticas finas | 167 |
| DOCKHORN Separadores | 245 |
| DOUGLAS Cánula para punción del seno maxilar | 320 |
| DOUGLAS Pinza depilatoria | 152 |
| DOUGLAS-BOZEMANN Pinza para tapónes | 208 |
| DOYEN ATRAUMATIC-GRIP Pinzas-clamps intestinales | 392-393 |
| DOYEN Martillos | 618 |
| DOYEN Periostótomos costales | 495 |
| DOYEN Pinza de campo | 200 |
| DOYEN Pinza para pólipos uterinos y ovarios | 457 |
| DOYEN Pinzas-clamps intestinales | 392-393 |
| DOYEN Separadores abdominales | 248-249 |
| DOYEN Sonda acanalada | 314 |
| DOYEN Tijeras abdominales | 106 |
| DOYEN Tirabuzón para mioma | 458 |
| DOYEN Valvas vaginales | 439 |
| DOYEN-BABY ATRAUMATIC-GRIP Pinzas-clamps intestinales | 391 |
| DOYEN-BABY Pinzas-clamps intestinales | 391 |
| DOYEN-STILLE Separadores | 247 |
| DUBOIS Tijeras para decapitación | 109 |
| DUPLAY Pinza para coger el cuello del útero | 453 |

| | |
|--|---------|
| DURACUT Alicates corta-alambres | 667 |
| DURACUT Cizallas corta-alambres | 665 |
| DURACUT Cizallas para escayolas | 676 |
| DURACUT Tijeras | 59 |
| DURACUT Tijeras adnex | 54 |
| DURACUT Tijeras de disección | 47-53 |
| DURACUT Tijeras finas | 45 |
| DURACUT Tijeras nasales | 58 |
| DURACUT Tijeras para cirugía | 46 |
| DURACUT Tijeras para el tabique nasal | 59 |
| DURACUT Tijeras para encías | 55 |
| DURACUT Tijeras para ginecología | 60 |
| DURACUT Tijeras para iridectomía | 45 |
| DURACUT Tijeras para la cirugía plástica | 45 |
| DURACUT Tijeras para la cirugía del recto | 59 |
| DURACUT Tijeras para ligaduras | 353 |
| DURACUT Tijeras para perineo | 60 |
| DURACUT Tijeras para vasos y fístulas | 45 |
| DURACUT Tijeras para vendajes | 673 |
| DURACUT Tijeras parametrium | 60 |
| DURACUT Tijeras uterinas | 60 |
| DURACUT Tijeras vasculares | 56-57 |
| DURANTE Pinzas para vasos y tumores | 149 |
| DUVAL Pinza intestinal | 149 |
| DUVAL Pinzas intestinales y para tejidos | 386-387 |
| DUVAL TITE GRIP Pinza intestinal y para tejidos | 388 |
| DUVAL-COLLIN Pinza intestinal | 149 |
| DUVAL-COLLIN Pinzas intestinales y para tejidos | 386 |

E

| | |
|--|---------|
| EASTMAN-RICHARDSON Separadores | 250 |
| EATON-BECKMANN Separador para laminectomía | 280 |
| ECHLIN Pinzas-gubias | 634 |
| EDER Porta-algodón | 409 |
| EICKEN-KILLIAN Cánulas para irrigación del seno maxilar | 322 |
| EISELBERG Tijera para ligadura | 352 |
| Elevadores | 574-575 |
| Elevadores para cabeza | 481 |
| Elevadores para caderas | 580 |
| Elevadores para huesos | 576-581 |
| Elevadores para luxación | 581 |
| Embudos | 751 |
| EMMET Gancho para fistulas | 221 |
| EMMET Pinza para vendajes y torundas | 207 |
| Empujador de sutura | 694 |
| Enchufe de conexión | 320 |
| Endoespéculos | 443 |
| Endoespéculos para cerviz y uretra | 448 |
| ENGEL Sierra para escayolas | 679 |
| ENGL. MOD. Pinza de campo | 200 |
| Enucleadores | 693 |
| ERRICO Fresa | 652 |
| Escariadores | 650 |
| Escofinas | 592-595 |
| Escofinas TITE GRIP | 596-597 |
| Escupideras | 751 |
| Esfinteroscopios | 407 |
| ESMARCH Cuchillo para escayolas | 679 |
| ESMARCH Tijeras para tela, cizallas para escayolas | 675 |
| ESMARCH Tubo-compresión | 570 |
| ESMARCH Venda-compresión | 570 |
| Espátulas abdominales e intestinales | 266-267 |
| Espátulas cerebrales | 706 |
| Espátulas para el pulmón | 260-265 |
| Espátulas para la íntima | 512-513 |
| Espátulas para la vesícula | 268 |
| Espátulas y dilatadores para la íntima | 512 |
| Espéculo lateral | 448 |
| Espéculos para el recto | 405-406 |
| Espéculos para la cirugía lumbar vertebral | 295 |
| Espéculos para la hipofisectomía | 692 |
| Espéculos vaginales | 430-442 |
| Espéculos vaginales para la cirugía con laser | 433 |
| Espejos frontales | 10 |
| Espejos laríngeos | 13-14 |
| Estesiometros | 4 |
| Estetoscopios | 5 |

| | |
|--|--------------|
| Estiletos para el canal lacrimonal | 312 |
| Estribos para extensión | 654, 658-659 |
| Estuches para esterilizar agujas | 357 |
| Estuches para sutura | 380 |
| EUFRATE PASQUE TITE GRIP Porta-agujas | 344 |
| EWALD Pinza fina de disección | 129 |
| EWALD Pinza fina quirúrgica | 140 |

F

| | |
|--|--------------|
| FAHLBUSCH-HARDY Disecadores | 693 |
| FANSLER-IVES Anoscopios | 407 |
| FARABEUF Periostótomos | 588 |
| FARABEUF Separadores | 227 |
| FARABEUF-ALEXANDER Periostótomos costales | 497 |
| FARABEUF-COLLIN Periostótomos | 588 |
| FARABEUF-LAMBOTTE Pinza para huesos | 626 |
| FARRELL (LATHBURY) Porta-algodones | 316 |
| FAURE Pinza-clamp para peritoneo | 193 |
| FAVALORO Tijera para arteria coronar | 95 |
| FEHLAND ATRAUMATIC-GRIP Pinzas para anastomosis del recto | 401 |
| FEILCHENFELD Pinza para espinas | 150 |
| FEIN Porta-algodones | 317 |
| FERGUSON Agujas quirúrgicas para sutura | 356 |
| FERGUSON (FRAZIER) Cánulas para aspiración | 323 |
| FERGUSON Pinza para huesos | 624 |
| FERRIS-SMITH Pinzas quirúrgicas | 147 |
| FERRIS-SMITH-CUSHING Pinzas cortantes para laminectomía | 713 |
| FERRIS-SMITH-KERRISON Pinzas cortantes para laminectomía | 709-710, 712 |
| Finas pinzas de disección | 128-131 |
| Finas pinzas hemostáticas | 164 |
| Finas pinzas hemostáticas ATRAUMATIC-GRIP | 165, 167 |
| Finas pinzas hemostáticas TITAN-LINE | 166, 168 |
| Finas tijeras de disección | 93 |
| Finas tijeras de disección y tenotomía | 92 |
| Finas tijeras DURACUT | 45 |
| Finas tijeras para cirugía | 68-70 |
| FINOCHIETTO modif. Separadores costales | 500 |
| FINOCHIETTO Pinza de torácica y ligadura | 564 |
| FINOCHIETTO Porta-agujas | 369 |
| FINOCHIETTO Separadores costales | 501, 503 |
| FINOCHIETTO TITE GRIP Porta-agujas | 346 |
| FINOCHIETTO-BABY Separador costal | 503 |
| FINOCHIETTO-BABY-HAIGHT Separador costal | 501 |
| FINOCHIETTO-BURFORD Separadores costales | 502-503 |
| FINOCHIETTO-INFANT Separador costal | 501 |
| FINOCHIETTO-RIENHOFF Separador costal | 506 |
| FINSEN Separadores con retenida automática | 270 |
| FISCH Ganchito para dura-madre | 212 |
| FISCHER Mondador de tendones | 646 |
| FLETCHER (JAVERTS) Pinza para torundas y esponjas | 210 |
| FOERSTER Separador abdominal | 308 |
| FOERSTER Valvas para separadores | 308 |
| FOERSTER-(FORBES) Pinza para torundas y esponjas | 210 |
| FOERSTER-BALLENGER Pinzas para torundas y esponjas | 209 |
| FOMON Escofinas con filo de lima y filo de escofina | 595 |
| FOMON Gancho para las coanas | 221 |
| FOMON Tijera para ala nasal | 81 |
| FOMON Tijeras DURACUT nasales | 58 |
| FOMON Tijeras nasales | 102 |
| FOMON Tijeras para la cirugía plástica | 82 |
| FOMON TITE GRIP Escofinas | 597 |
| FORBES (FOERSTER) Pinza para torundas y esponjas | 210 |
| Fórceps | 478-480 |
| FORD-DEAVER Separador y espátula para el pulmón | 263 |
| FOSS Separador y espátula para el pulmón | 263 |
| FOX Curetas para lupus | 20 |
| FOX-GOLDMANN Tijeras DURACUT para encías | 55 |
| FOX-GOLDMANN Tijeras para encías | 94 |
| FRANZ Separador abdominal | 304 |
| FRAZIER (FERGUSON) Cánulas para aspiración | 323 |
| FRAZIER Cánulas para aspiración | 323 |
| FRAZIER Disecador para dura-madre | 698 |
| FRAZIER Gancho para piel y dura-madre | 216-217 |
| FREER Cinceles | 607 |
| FREER Periostótomos | 583 |
| FREER Separador | 218 |

| | |
|--|-----|
| FRENCH EYE TITE GRIP Micro-Porta-agujas | 340 |
| FRENZEL Depresor lingual | 12 |
| Fresas | 652 |
| FREY-SAUERBRUCH Costótomo | 493 |
| FRIEDMAN-LUER Pinza-gubia | 631 |
| FRICTSCH Separadores | 250 |
| FROHN Porta-algodones | 316 |
| FRYKHOLM Pinzas-gubias | 635 |

G

| | |
|--|--------------|
| Gafas de lupa binocular | 9 |
| GALLAHER Escofina | 592 |
| Ganchitos auriculares | 213 |
| Ganchitos para dura-madre | 212 |
| Ganchos | 449, 696 |
| Ganchos con muelle para la fijación de la galea | 691 |
| Ganchos para cirugía plástica | 271-218, 226 |
| Ganchos para cripta (Sondas para fistula) | 409 |
| Ganchos para decapitación | 485 |
| Ganchos para decompresión | 701 |
| Ganchos para dura-madre | 217-218 |
| Ganchos para el bulbus | 422 |
| Ganchos para estrabismo | 213 |
| Ganchos para exploración y coagulación | 215 |
| Ganchos para fistulas | 221 |
| Ganchos para galea | 691 |
| Ganchos para iris | 216-218 |
| Ganchos para la microcirugía | 212 |
| Ganchos para las coanas | 221 |
| Ganchos para nervios y vasos | 213-215 |
| Ganchos para piel | 216-218 |
| Ganchos para piel y dura-madre | 216-217 |
| Ganchos para separadores | 287, 289 |
| GANSKE-BIRCHER Pinzas para menisco y cartilago | 640 |
| GARRETT (DE BAKEY) Dilatadores vasculares | 510 |
| Garrotes | 22 |
| Garrotes de madera | 22 |
| GAYLOR-THOMS Pinza saca-bocados para biopsia | 460 |
| GEISSENDOERFER-OVERHOLT Pinzas de disección y ligaduras | 184 |
| GELPI Separadores para la vulva | 281 |
| GELPI-BABY Separador para la vulva | 281 |
| GELPI-SELETZ Separador para la vulva | 281 |
| GEMINI Pinzas de disección y ligaduras | 181 |
| GEMINI-MIXTER Pinzas de disección y ligaduras | 181 |
| GERALD Pinza de disección TITE GRIP | 114 |
| GERALD Pinza quirúrgica TITE GRIP | 117 |
| GERALD Pinzas finas de disección | 130 |
| GERALD Pinzas finas quirúrgicas | 142 |
| GERSTER Barra de tracción para pinzas porta-huesos | 630 |
| GERZOG Martillo | 618 |
| GIBBON-BAILEY Aproximador para costillas | 508 |
| GIERTZ-STILLE Costótomo | 492 |
| GIGLI (OLIVECRONA) Sierras de hilo | 687 |
| GIGLI Mango con gancho | 687 |
| GILLIES (CONVERSE) Ganchos para piel y dura madre | 216 |
| GILLIES Gancho para piel | 216 |
| GILLIES Pinza quirúrgica TITE GRIP | 117 |
| GILLIES Pinzas finas quirúrgicas | 142 |
| GILLIES Porta-agujas con tijera | 370 |
| GILLIES TITE GRIP Porta-agujas | 348 |
| GILLIES-BABY Porta-agujas con tijera | 370 |
| GILLIES-BABY TITE GRIP Porta-agujas | 348 |
| GIL-VERNET (MARBERGER) Separadores para venas y hilares | 223 |
| GLASSMANN (KILNER) Tijeras para la cirugía y disección | 83 |
| GLOVER ATRAUMATIC-GRIP Pinzas-clamps para anastomosis | 544 |
| GLOVER-DE BAKEY ATRAUMATIC-GRIP Clamps Bulldog | 525 |
| GLUCK Costótomo | 492 |
| GOELET Separador | 229 |
| GOLDMANN-FOX Tijeras DURACUT para encías | 55 |
| GOLDMANN-FOX Tijeras para encías | 94 |
| Goniómetro para extremidades | 7 |
| GOOD Tijera para amígdalas | 103 |
| GOODELL Dilatador uterino | 443 |
| GORNEY Tijera DURACUT para el tabique nasal | 59 |
| GORNEY Tijeras para la cirugía plástica | 82 |
| GOSSET Separador abdominal | 299-300 |
| GOSSET-BABY Separador abdominal | 299 |

GOURDET Cucharillas uterinas 466
GRAEFE (TYRELL) Ganchos para iris 216
GRAEFE (TYRELL) Ganchos para piel 216
GRAEFE Ganchos para estrabismo. 213
GRAEFE Pinza quirúrgica 148
GRAEFE Pinzas finas de disección 128
GRAEFE Pinzas finas quirúrgicas 139
GRAHAM Gancho para dura-madre 217
GRAMCKO-BUCK Elevador para huesos 576
 Grapas (Agrafes) 379
 Grapas de plata en tubo de plástico. 690
GRAVE Espéculos vaginales 432
GRAVE Espéculos vaginales para la cirugía con laser 433
GRAVE modif. Espéculos vaginales 432
GREEN Pinza de campo 200
GREEN Separador para la glándula tiroidea 243
GREEN-ARMYTAGE Pinza-clamp uterina para hemostasis 481
GREEN-SENN Separadores 224
GREGORY ATRAUMATIC-GRIP Pinzas-clamps para la profunda 534
GREGORY-SOFT ATRAUMATIC-GRIP Clamps Bulldog 527
GRONINGEN Ganchos para nervios y vasos 215
GROSS Pinzas para vendajes y torundas 204
GRUENWALD (JANSEN) Pinzas auriculares y nasales 136
GRUENWALD-LOVE Pinzas cortantes para laminectomía 716
 Gubias 607, 609-616
 Gubias de esponjosa 615
 Gubias espinales 616
 Gubias, hojas intercambiables 611
 Guía-ligadura 697
 Guías para catéteres (introdutor) 425
GUNNAR-HEY Rodillo para tubos 203
GUTHRIE Ganchos para piel 218
GUYON Guía para catéteres (introdutor) 425
GUYON Instrumento para introducir catéteres 425
GUYON Pinza-clamp para renal 190
GUYON-DE BAKEY ATRAUMATIC-GRIP Pinzas-clamps para renal 190

H

HABERER Espátula abdominal e intestinal 267
HAIGHT Separador costal 506
HAIGHT-FINOCCHIETTO-BABY Separador costal 501
HAJEK Martillos 617
HAJEK-KOFLER Pinzas cortantes para laminectomía 708
HALLE Cucharillas cortantes 604
HALLE Cuchillo para dura-madre 37
HALLE Espátula para la íntima 512
HALLE Periestótomos 582
HALSEY Porta-agujas 363
HALSEY TITE GRIP Porta-agujas 342
HALSEY TITE GRIP Porta-agujas para zurdos 341
HALSTED Pinzas hemostáticas finas 169, 171
HALSTED-MICRO Pinzas hemostáticas finas 164
HALSTED-MOSQUITO (HEISS) Pinzas hemostáticas finas 170
HALSTED-MOSQUITO Pinzas hemostáticas finas 164-165, 170
HALSTED-MOSQUITO-DE BAKEY ATRAUMATIC-GRIP Pinzas hemostáticas finas 165
HARDY Curetas 692
HARDY Disecadores 693
HARDY Enucleadores 693
HARDY Horquilla para implantar 693
HARDY-FAHLBUSCH Disecadores 693
HARKEN-DE BAKEY ATRAUMATIC-GRIP Pinzas para disección y ligaduras 551
HARRINGTON Separadores y espátulas para el pulmón 262
HARRINGTON-MAYO Tijeras de disección 86
HARTMANN Cateter de eustaquio 322
HARTMANN Diapasónes 4
HARTMANN Pinza saca-bocados para biopsia 462
HARTMANN Pinzas hemostáticas finas 164
HARTMANN-COLLIN Separador 229
HASSELTIME Clamps umbilicales 486
HAVERFIELD-SCOVILLE Separador para laminectomía 286
HAYES ATRAUMATIC-GRIP Pinza para anastomosis del recto 400
HEANEY Pinzas quirúrgicas 147
HEANEY Pinzas-clamps para histerectomía 196
HEANEY Porta-agujas 369
HEANEY TITE GRIP Porta-agujas 346

HEANEY-BALLENTINE Pinza-clamp para histerectomía 196
HEANEY-DE BAKEY (ROGERS) ATRAUMATIC-GRIP Pinzas-clamps para histerectomía 197
HEANEY-REZEK Pinza-clamp para histerectomía 196
HEANEY-SIMON Separador para cirugía profunda 254
HEATH Martillo 620
HEATH-RICHTER Pinza para quitar agrafes 379
HEGAR Dilatadores uterinos. 444-445
HEGAR-BABY-OLSEN TITE GRIP Porta-agujas 348
HEGAR-BAUMGARTNER TITE GRIP Porta-agujas 342
HEGAR-CORWIN TITE-GRIP Pinza cierra-hilos 662
HEGAR-MAYO Porta-agujas 367
HEGAR-MAYO TITE GRIP Porta-agujas 345
HEGAR-MAYO TITE GRIP Porta-agujas para zurdos 341
HEGAR-OLSEN Porta-agujas con tijera 370
HEGAR-OLSEN TITE GRIP Porta-agujas 348
HEGEMANN-DIETRICH Tijeras DURACUT vasculares 56
HEGEMANN-DIETRICH Tijeras vasculares 96
HEGENBARTH Pinza para poner agrafes 379
HEIFETZ Espátulas cerebrales 706
HEIFETZ Pinzas de agarre para tejido y tumor 127
HEISS (HALSTED-MOSQUITO) Pinzas hemostáticas finas 170
HEISS (MIXTER-PAUL) Pinza de disección y ligaduras 182
HEISTER Abre-boca 22
HEMINGWAY Cucharillas cortantes 599
HENLEY Separadores con retenida automática 282-283
HENNIG Separador para escayolas 682
HERRICK Pinza-clamp para pedúnculo renal 191
HEY-GUNNAR Rodillo para tubos 203
HEYMANN Tijeras DURACUT nasales 58
HEYMANN Tijeras nasales 101
HEYWOOD-SMITH Pinza para pólipos uterinos y ovarios 457
HEYWOOD-SMITH Pinza tira-lengua 23
HIBBS Separadores 231
HIBBS Separadores espinales 231
 Hilo de plata 690
 Hilos de cerclaje 660
HIRSCHMANN Anoscopios 407
 Histerómetros 446
HOEN Periestótomos 586
HOGLUND-LOWMAN Pinza porta-huesos 630
HOHMANN Elevadores para huesos 578-580
HOHMANN-ALDINGER Elevador para huesos 580
HOHMANN-LANGE Elevadores para huesos 577
HOHMANN-LANGE modif. Elevadores para huesos 577
HOHMANN-MINI Elevadores para huesos 576
 Hojas 36
 Hojas de afeitar 36
 Hojas de bisturíes 34-35
 Hojas de micro-bisturí 473
 Hojas intercambiables 611
HOKÉ Osteótomos 607
HOLSHER Separador para la raíz de nervios 701
HOLZBACH Pinzas-clamps para histerectomía 194
HOPKINS Cuchillos para escayolas 679
HOPKINS-JOHNS ATRAUMATIC-GRIP Pinza para poner y quitar clamps Bulldog 527
HOPKINS-JOHNS Clamps Bulldog 163
HORGAN Separador abdominal 303
HORNE-JOBSON Porta-algodones 317
 Horquilla para implantar 693
 Horquilla para ligadura 378
HORSLEY Disecador para dura-madre 698
HORSLEY-LISTON-KEY Pinza cortante para huesos 494
HÖSEL Separadores 246
HOSPITAL-PROVIDENCE Pinzas hemostáticas finas 168
HOUSE Cucharillas cortantes 598
HOWARD Periestótomos 583
HRYNTSCHAK-YOUNG Porta-agujas de bumerang 372
HUDSON Perforador de mano 652
HULKA Pinza para coger el cuello del útero 453
HULKA-KENWICK Pinza para coger el cuello del útero 453
HUMBY Dermátomo 42
HUNTER Pinzas para espinas 150
HURD Agujas para ligaduras 374

I

| | |
|---|----------|
| Iluminaciones-proximales | 472 |
| Imperdibles para esterilización, Porta-instrumentos | 736 |
| INFANT-FINOCCHIETTO Separador costal | 501 |
| INGE Separadores para cuerpos vertebrales | 296 |
| Instrumental para grapar | 690-691 |
| Instrumental para histero-salpingografía | 474 |
| Instrumental para la amniocopia | 472-473 |
| Instrumental para la micro-extracción de sangre | 472-473 |
| Instrumentos de cerclaje | 660 |
| Instrumentos de medición | 7 |
| Instrumentos de uretrografía | 426 |
| Instrumentos para apertura craneana | 687 |
| Instrumentos para biopsia ósea | 669 |
| Instrumentos para circuncisión | 426 |
| Instrumentos para exámenes y medición | 6 |
| Instrumentos para examinar la sensibilidad | 4 |
| Instrumentos para introducir catéteres | 425 |
| Instrumentos para la cirugía laser | 448-451 |
| Instrumentos para la hipofisectomía | 692-693 |
| Instrumentos para la prostatectomía | 423 |
| Instrumentos para la urología | 425-426 |
| Instrumentos para medir | 448 |
| Instrumentos para microrcirugía | 694-697 |
| Instrumentos para obstétrica | 481, 486 |
| Instrumentos para sutura | 378 |
| Instrumentos para traqueotomía | 728 |
| Instrumentos para tunelar e injertar Bypass | 517 |
| Instrumentos para uñas | 645 |
| IOWA Aguja de guía | 486 |
| IOWA Aguja hipodérmica | 486 |
| IOWA Pinza para la vejiga amniótica | 477 |
| Irrigadores | 751 |
| ISRAEL Separadores | 237 |
| IVES-FANSLER Anoscopios | 407 |

J

| | |
|---|----------|
| JACKSON Espéculos vaginales | 438 |
| JACKSON Pinza para agarrar el tendón | 647 |
| JACKSON Separador para la tráquea | 217, 226 |
| JACKSON-CHEVALIER Cánula traqueal | 726 |
| JACOBS Pinza para coger el cuello útero | 456 |
| JACOBSON Cuchillo para vasos | 694-695 |
| JACOBSON Empujador de sutura | 694 |
| JACOBSON Micro-tijeras | 64 |
| JACOBSON PERFECT-GRIP Micro-Porta-agujas | 359 |
| JACOBSON Sonda abotonada | 694 |
| JACOBSON Sonda doble | 694 |
| JACOBSON TITE GRIP Micro-Porta-agujas | 338 |
| JAMESON Porta-agujas | 368 |
| JAMESON Tijeras finas de disección | 93 |
| JANET Cilindros | 331 |
| JANET Jeringas para enjuagar la vejiga y heridas | 331 |
| JANSEN (GRUENWALD) Pinzas auriculares y nasales | 136 |
| JANSEN Cucharillas cortantes | 599 |
| JANSEN Lámpara frontal para corriente de baja tensión | 11 |
| JANSEN Periostótomo | 587 |
| JANSEN Pinzas-gubias | 632 |
| JANSEN Separadores con retenida automática | 272 |
| JANSEN-ZAUFAL Pinza-gubia | 633 |
| JAVERTS (FLETCHER) Pinza para torundas y esponjas | 210 |
| DAVID ATRAUMATIC-GRIP Pinzas-clamps para carótida | 537 |
| Jeringa para tuberculina | 330 |
| Jeringas | 330-332 |
| Jeringas auriculares | 332 |
| Jeringas para enjuagar la vejiga y heridas | 331 |
| Jeringas para insulina | 330 |
| JOBSON-HORNE Porta-algodones | 317 |
| JOHNS-HOPKINS ATRAUMATIC-GRIP Pinza para poner y quitar clamps Bulldog | 527 |
| JOHNS-HOPKINS Clamps Bulldog | 163 |
| JONES Pinzas de campo | 200 |
| JONES-LELAND ATRAUMATIC-GRIP Pinzas-clamps para vasos periféricos | 534 |
| JORGENSON Tijera de disección | 98 |

| | |
|--|----------|
| JOSEPH Bisturí para rinoplastia | 37 |
| JOSEPH Gancho para cirugía plástica | 217, 219 |
| JOSEPH Lima para huesos | 592 |
| JOSEPH Periostótomo | 582 |
| JOSEPH Tijeras DURACUT para la cirugía plástica | 45 |
| JOSEPH Tijeras para la cirugía plástica | 70 |
| JUDD-ALLIS Pinzas intestinales y para tejidos | 384 |
| JUDD-MASSON Separador para la vejiga | 310 |
| Juego para biopsia vertebral | 720-721 |
| Juego para endarterectomía | 515 |
| Juego para traqueotomía | 729-730 |
| Juego para tunelar | 516 |
| Juego para várices | 315 |

K

| | |
|--|--------------|
| KADER Espátulas abdominales e intestinales | 267 |
| KALLMORGEN Espéculos vaginales | 434 |
| KALLMORGEN Juego de espéculos y valvas vaginales | 434 |
| KALLMORGEN Valvas vaginales | 434 |
| KALT Agujas vasculares | 354 |
| KALT Porta-agujas | 363 |
| KATSCH Sacacomedones | 19 |
| KAY-LAMBERT ATRAUMATIC-GRIP Pinzas-clamps para anastomosis de aorta | 549 |
| KAZANJIAN Pinza cortante para huesos | 637 |
| KELLY Esfinteroscopios | 407 |
| KELLY Pinza para pólipos uterinos y ovarios | 457 |
| KELLY Pinzas hemostáticas finas | 168 |
| KELLY Pinzas hemostáticas finas TITAN-LINE | 168 |
| KELLY Separadores | 251 |
| KELLY Separadores para cirugía profunda | 255 |
| KELLY Tijeras DURACUT para vasos y fístulas | 45 |
| KELLY Tijeras para vasos y fístulas | 80 |
| KELLY-BABY Pinzas hemostáticas finas | 168 |
| KELLY-RANKIN Pinzas hemostáticas finas | 169 |
| KENWICK-HULKA Pinza para coger el cuello del útero | 453 |
| KERN-LANE Pinza para huesos | 625 |
| KERN-MINI Pinza para huesos | 625 |
| KERRISON Pinza cortante para laminectomía | 707 |
| KERRISON-FERRIS-SMITH Pinzas cortantes para laminectomía | 709-710, 712 |
| KERRISON-LOVE (COLCLOUGH) Pinzas cortantes para laminectomía | 710-711 |
| KEVOURKIAN-PACIFIC Pinza saca-bocados para biopsia | 464 |
| KEVOURKIAN-YOUNGE Curetas para biopsia endo-cerviz | 459 |
| KEVOURKIAN-YOUNGE Pinzas saca-bocados para biopsia | 463, 465 |
| KEY Periostótomos | 589 |
| KEYES Trépanos cutáneos | 20 |
| KEY-HORSLEY-LISTON Pinza cortante para huesos | 494 |
| KIELAND Fórceps | 479 |
| KIELAND-LUIKART Fórceps | 479 |
| KILLIAN (MÜHLING) Tijera para el tabique nasal | 102 |
| KILLIAN Periostótomos | 583 |
| KILLIAN-EICKEN Cánulas para irrigación del seno maxilar | 322 |
| KILNER (GLASSMANN) Tijeras para la cirugía y disección | 83 |
| KILNER Ganchos para piel | 216 |
| KILNER Tijeras finas de disección | 93 |
| KILNER TITE GRIP Porta-agujas | 342 |
| KIRK Martillo | 618 |
| KIRKLIN Separadores para venas | 223 |
| KIRSCHNER Agujas | 655 |
| KIRSCHNER Estribos para extensión | 658-659 |
| KIRSCHNER Separadores abdominales | 306 |
| KIRSCHNER Sondas conductoras | 377 |
| KIRSCHNER Valvas para separadores abdominales | 307 |
| KIRSCHNER-BALFOUR Valvas para separadores abdominales | 307 |
| KLAPP Separadores para vainas tendinosas | 225 |
| KLEINERT-KUTZ Pinza para pasar tendones | 649 |
| KLEINSCHMIDT Machacadora para espora y clamp para apendectomía | 403 |
| KLIMA-ROSEGGGER Agujas | 518 |
| KLIMA-ROSEGGGER Agujas para la punción del esternón | 329 |
| KLINGENBERGH-LOTH Tijera de disección | 98 |
| KNAPP Separadores | 218 |
| KNAPP Tijeras finas para cirugía | 68 |
| KNIGHT Tijeras DURACUT nasales | 58 |
| KNIGHT Tijeras nasales | 101 |

| | |
|--|---------------|
| KNOWLES Tijera para vendajes | 673 |
| KNUTSON Instrumento de uretrografía | 426 |
| KOCHER ATRAUMATIC-GRIP Pinzas-clamps intestinales | 395 |
| KOCHER Espátula para la vesícula | 268 |
| KOCHER Pinzas hemostáticas | 176 |
| KOCHER Pinzas-clamps intestinales | 392-394 |
| KOCHER Separadores | 235, 242, 244 |
| KOCHER Sondas para bocio | 378 |
| KOCHER Separadores y separadores para huesos | 232 |
| KOCHER-BABY ATRAUMATIC-GRIP Pinzas-clamps intestinales | 391 |
| KOCHER-BABY Pinzas-clamps intestinales | 391 |
| KOCHER-LANGENBECK Separadores | 240 |
| KOCHER-OCHSNER Pinzas hemostáticas | 177 |
| KOENIG Sondas conductoras | 377 |
| KOERTE Separadores | 236 |
| KOERTE-LUER Cucharillas para los cálculos biliares | 417 |
| KOFLER-HAJEK Pinzas cortantes para laminectomía | 708 |
| KOGAN Endoespéculos para cerviz y uretra | 443, 448 |
| KÖLN MOD. Pinza hemostática para cuero cabelludo | 691 |
| KÖNIG Periostótomo | 582 |
| KÖNIG-ROSER Abre-boca | 22 |
| KONRICH Tambores de esterilización | 743 |
| KOOS Cuchillos para vasos | 695 |
| KRAUS Cuchillo para vasos | 695 |
| KRAUSE Cánula para punción del seno maxilar | 319 |
| KRAYENBÜHL Ganchos para nervios y vasos | 215 |
| KRISTELLER Espéculos y valvas vaginales | 434-437 |
| KRISTELLER Espéculos vaginales | 434-437 |
| KRISTELLER Valvas vaginales | 434-437 |
| KROENLEIN Pinza hemostática | 173 |
| KRONECKER Agujas para ligaduras | 374 |
| KÜHNE Pinza porta-laminilla | 152 |
| KUTZ-KLEINERT Pinza para pasar tendones | 649 |

L

| | |
|---|---------|
| LA GRANGE Tijera para encías | 94 |
| LABORDE Dilatador para la tráquea | 728 |
| LAHEY Pinza de disección y ligaduras | 189 |
| LAHEY Pinza para coger el cuello útero | 454 |
| LAHEY Separador para bocio | 224 |
| LAHEY Separadores | 219 |
| LAHEY-SWEET Pinza de disección y ligaduras | 189 |
| LAMBERT-KAY ATRAUMATIC-GRIP Pinzas-clamps para anastomosis de aorta | 549 |
| LAMBERT-LOWMAN Pinza porta-huesos | 630 |
| LAMBOTTE Osteótomos | 608 |
| LAMBOTTE Periostótomos costales | 497 |
| LAMBOTTE Pinzas para huesos | 626-627 |
| LAMBOTTE-FARABEUF Pinza para huesos | 626 |
| LAMBOTTE-MINI Osteótomos | 608 |
| Lámparas frontales para corriente de baja tensión | 11 |
| LANDAU Espéculos vaginales | 440 |
| LANDAU-COLLIN Espéculos vaginales | 431 |
| LANDOLT Periostótomo | 585 |
| LANDOLT-CUSHING Espéculos para la hipofisectomía | 692 |
| LANE Pinza de campo | 201 |
| LANE Pinza para huesos | 625 |
| LANE-KERN Pinza para huesos | 625 |
| LANE-MURPHY Elevador para luxación | 581 |
| LANGE Tijera para vendajes | 672 |
| LANGE-HOHMANN Elevadores para huesos | 577 |
| LANGE-HOHMANN modif. Elevadores para huesos | 577 |
| LANGENBECK Cuchillo para lóbulos | 39 |
| LANGENBECK Cuchillo para resección | 38 |
| LANGENBECK Elevadores | 575 |
| LANGENBECK Periostótomos | 587 |
| LANGENBECK Pinza para huesos | 624 |
| LANGENBECK Separadores | 238-239 |
| LANGENBECK Sierra para amputación y resección | 572 |
| LANGENBECK TITE GRIP Porta-agujas | 350 |
| LANGENBECK-KOCHER Separadores | 240 |
| LANGENBECK-MINI Separadores | 224 |
| LANGENBECK-PARKER (US-ARMY) Separadores | 231 |
| LANGENBECK-RYDER TITE GRIP Porta-agujas | 350 |
| Lápiz para marcar y escribir sobre metal | 757 |
| Laringoscopios | 24-31 |
| LATHBURY (FARRELL) Porta-algodones | 316 |

| | |
|---|--------------|
| LAWRENCE Pinza de disección y ligaduras | 187 |
| LAWTON TITE GRIP Porta-agujas | 349 |
| LAWTON-MATHIEU TITE GRIP Porta-agujas | 349 |
| LAZAR Micro-pinzas de ligadura | 121 |
| LEBSCHKE Cíncel para esternón | 492 |
| LEES ATRAUMATIC-GRIP Pinzas-clamps bronquiales | 552 |
| Legra para lupus | 19 |
| Legras | 694-697 |
| LEGUEU Espátula para la vesícula | 268 |
| LEKSELL-STILLE Pinzas-gubias | 635 |
| LELAND-JONES ATRAUMATIC-GRIP Pinzas-clamps para vasos periféricos | 534 |
| LEMMON Espátulas para la íntima | 512 |
| LEMPERT Cucharillas cortantes | 604 |
| LEMPERT Periostótomos | 584 |
| LEMPERT Pinzas-gubias | 631-632 |
| LERICHE Pinzas hemostáticas finas | 165 |
| LEWIN Pinza para reducción | 622 |
| LEWIS Escofina | 592 |
| LEXER Gubias | 612-613 |
| LEXER Gubias de esponjosa | 615 |
| LEXER Osteótomos | 612-613 |
| LEXER Tijeras de disección | 87 |
| LEXER Tijeras DURACUT de disección | 49 |
| LEXER-BABY Tijeras de disección | 87 |
| LEXER-MAYO Tijeras de disección | 87 |
| LEXER-MAYO Tijeras DURACUT de disección | 48 |
| LEXER-MINI Gubias | 612 |
| LEXER-MINI Osteótomos | 612 |
| LEYLA Separadores automáticos para el cerebro | 702 |
| LEYLA Separadores para la fijación a la mesa de operaciones | 704 |
| LICHTENBERG TITE GRIP Porta-agujas | 349 |
| LICHTWITZ Cánulas para punción del seno maxilar | 319-320 |
| LICHTWITZ V.EICKEN Cánula para punción del seno maxilar | 319 |
| Ligadores de aspiración para hemorroides | 411 |
| Ligadores para hemorroides | 410 |
| Limas para huesos | 592, 594-595 |
| Limas para uñas | 18 |
| LINDORF TITE-GRIP Pinza cierra-hilos | 662 |
| LISTER DURACUT Tijera para vendajes | 673 |
| LISTER modif. Tijeras para vendajes | 673 |
| LISTER Pinzas para senos | 204 |
| LISTER Tijera universal para vendajes y tela | 674 |
| LISTER Tijeras para vendajes | 673 |
| LISTON Cuchillos para amputación | 38 |
| LISTON Pinzas cortantes para huesos | 637, 639 |
| LISTON-KEY-HORSLEY Pinza cortante para huesos | 494 |
| LISTON-LITTAUER Pinza cortante para huesos | 637 |
| LISTON-RUSKIN Pinzas cortantes para huesos | 638 |
| LISTON-WALTON (BÖHLER) Pinzas cortantes para huesos | 638 |
| LITTAUER Pinza depilatoria | 152 |
| LITTAUER Tijera para ligadura | 352 |
| LITTAUER-LISTON Pinza cortante para huesos | 637 |
| LITTLER Tijera de disección | 81 |
| Llaves | 333 |
| LOCKHART-MUMMERY Sondas para fistulas | 314 |
| LOCKLIN Tijeras DURACUT para encías | 55 |
| LOCKLIN Tijeras para encías | 94 |
| LOCKWOOD Pinza intestinal y para tejidos | 386 |
| LONG Pinza-clamp para histerectomía | 194 |
| LORNA Pinzas de campo | 202 |
| LOTH-KLINGENBERGH Tijera de disección | 98 |
| LOTH-SCHOEMAKER Tijera para ligadura | 352 |
| LOUTE Tensor cierra-hilo | 660 |
| LOVE Separadores para la raíz de nervios | 701 |
| LOVE-GRUENWALD Pinzas cortantes para laminectomía | 716 |
| LOVE-KERRISON (COLCLOUGH) Pinzas cortantes para laminectomía | 710-711 |
| LOVELACE Pinza intestinal y para tejidos | 387 |
| LOVELACE-DIXON Pinzas hemostáticas finas | 169 |
| LOWER Pinza de disección y ligaduras | 189 |
| LOWMAN Pinzas porta-huesos | 630 |
| LOWMAN-HOGLUND Pinza porta-huesos | 630 |
| LOWMAN-LAMBERT Pinza porta-huesos | 630 |
| LUCAE Diapasón | 4 |
| LUCAE Ganchitos auriculares | 213 |
| LUCAE Martillo | 617 |
| LUCAE Pinzas auriculares y nasales | 136 |
| LUCAS Cucharillas cortantes | 599 |

| | |
|--|----------|
| LUER Cánulas traqueales | 725 |
| LUER Pinzas-gubias | 631-632 |
| LUER Separadores | 227 |
| LUER-FRIEDMAN Pinza-gubia | 631 |
| LUER-KOERTE Cucharillas para los cálculos biliares | 417 |
| LUER-STILLE Pinzas-gubias | 634, 636 |
| LUIKART-KIELAND Fórceps | 479 |
| Lupas frontales binoculares | 8-9 |

M

| | |
|---|--------------|
| Machacadora para espora | 403 |
| MAGILL Pinzas para introducir catéteres | 32 |
| MAIER Pinzas para vendajes y torundas | 205 |
| MAIER-SIMS Pinzas para vendajes y torundas | 205 |
| MALTZ Escofina | 593 |
| MALTZ TITE GRIP Escofinas | 596 |
| Mandriles | 653 |
| Mango con gancho | 687 |
| Mango para aspiración | 320 |
| Mango para hojas intercambiables | 611 |
| Mangos de bisturíes | 34-35 |
| Mangos metálicos para espejos laríngeos | 13 |
| Manos de plomo | 644 |
| MARBACH Tijera para perineo (episiotomía) | 107 |
| MARBERGER (GIL-VERNET) Separadores para venas y hilares | 223 |
| MARKWALDER Pinza gubia redonda | 494 |
| MARQUARDT Pinza-gubia | 634 |
| Martillos | 2-3, 617-621 |
| Martillos de percusión | 2-3 |
| MARTIN Pelvímetro | 477 |
| MARTIN Pinzas para menisco y cartilago | 640 |
| MARTIN Separador para cirugía profunda | 254 |
| MARTINI Cucharillas cortantes | 598 |
| MASSON Porta-agujas | 368 |
| MASSON TITE GRIP Porta-agujas | 347 |
| MASSON-JUDD Separador para la vejiga | 310 |
| MASTIN Pinza-clamp para músculos | 728 |
| Material para sutura | 353 |
| MATHIEU Espéculo para el recto | 405 |
| MATHIEU Espéculos vaginales | 439 |
| MATHIEU Porta-agujas | 371 |
| MATHIEU Separadores | 226, 231 |
| MATHIEU TITE GRIP Porta-agujas | 349 |
| MATHIEU Valvas vaginales | 439 |
| MATHIEU-LAWTON TITE GRIP Porta-agujas | 349 |
| MATSON Perióstotomo costal | 497 |
| MATZNAUER Espéculos vaginales | 440 |
| MAUNDER Garrote de madera | 22 |
| MAYFIELD Pinza-gubia | 633 |
| MAYO Cucharilla para los cálculos biliar | 417 |
| MAYO Depresor lingual | 12 |
| MAYO Imperdibles para instrumentos | 736 |
| MAYO Pinza para vasos y tumores | 149 |
| MAYO Separador abdominal | 249 |
| MAYO Tijeras de disección | 84 |
| MAYO Tijeras DURACUT de disección | 47 |
| MAYO-ADAMS Separadores para apendectomía | 284 |
| MAYO-BLAKE Pinzas para los cálculos biliares | 418 |
| MAYO-HARRINGTON Tijeras de disección | 86 |
| MAYO-HEGAR Porta-agujas | 367 |
| MAYO-HEGAR TITE GRIP Porta-agujas | 345 |
| MAYO-HEGAR TITE GRIP Porta-agujas para zurdos | 341 |
| MAYO-LEXER Tijeras de disección | 87 |
| MAYO-LEXER Tijeras DURACUT de disección | 48 |
| MAYO-NOBLE Tijeras de disección | 86 |
| MAYO-ROBSON ATRAUMATIC-GRIP Pinzas-clamps intestinales | 396 |
| MAYO-ROBSON Pinzas-clamps intestinales | 396 |
| MAYO-STILLE Tijeras de disección | 85 |
| MAYO-STILLE Tijeras DURACUT de disección | 48 |
| MC DONALD Disecador | 574 |
| MC GIVNEY Pinza-clamp para hemorroides | 410 |
| MC INDOE Pinza cortante para huesos | 638 |
| MC INDOE Pinza de disección TITE GRIP | 113 |
| MC INDOE Pinza fina de disección | 130 |
| MC INDOE Tijera para cartilago | 82 |
| MC INTOSH Laringoscopios | 24-27 |
| MC KENTY Perióstotomo | 582 |

| | |
|--|--------------|
| MC KENZIE Fresa | 652 |
| MC KENZIE Grapas de plata en tubo de plástico | 690 |
| MC KENZIE Hilo de plata | 690 |
| MC KENZIE Pinzas clipadoras | 690 |
| MC KENZIE Porta-grapas | 690 |
| MC PHERSON Micro-pinzas de ligadura | 122 |
| MEAD Martillo | 618 |
| MEAD Pinzas-gubias | 631 |
| Meatótomo | 426 |
| MEEKER Pinza de disección y ligaduras | 187 |
| MEEKER-BABY Pinzas de disección y ligaduras | 180 |
| MENGHINI Agujas para la punción ciega del hígado | 329 |
| MENGHINI Agujas para la punción del hígado | 329 |
| MERCEDES Separador torácico | 507 |
| METZENBAUM Tijeras de disección | 88-90 |
| METZENBAUM Tijeras DURACUT | 54 |
| METZENBAUM Tijeras DURACUT de disección | 49-52 |
| METZENBAUM-BABY Tijeras de disección | 89 |
| METZENBAUM-NELSON Tijeras de disección | 91 |
| METZENBAUM-NELSON Tijeras DURACUT de disección | 53 |
| METZENBAUM-THOREK Tijeras DURACUT adnex | 54 |
| MEYERDING Separadores | 225 |
| MEYERDING Separadores para laminectomía | 284 |
| MICHEL Agrafes (grapas) | 379 |
| MICHEL Espejos rinoscópicos | 14 |
| MICHEL Pinza para poner agrafes | 379 |
| MICHEL Pinza para poner y quitar agrafes | 379 |
| MICRO-ADSON Pinzas finas de disección | 129 |
| MICRO-ADSON Pinzas finas quirúrgicas | 140-141 |
| MICRO-ADSON Pinzas quirúrgicas TITE GRIP | 117 |
| MICRO-CASTROVIEJO Micro-Porta-agujas | 358 |
| Micro-Clamps Bulldog | 162 |
| MICRO-CRILE Pinzas hemostáticas finas | 166 |
| MICRO-HALSTED Pinzas hemostáticas finas | 164 |
| Micro-pinzas | 120-125 |
| Micro-pinzas (modelos de relojero) | 120 |
| Micro-pinzas de agarre | 124 |
| Micro-Pinzas de agarre PERFECT-GRIP | 124 |
| Micro-pinzas de ligadura | 121-123 |
| Micro-pinzas de ligadura PERFECT-GRIP | 123 |
| Micro-pinzas TITE GRIP | 118 |
| Micro-Porta-agujas | 358-362 |
| Micro-Porta-agujas PERFECT-GRIP | 359, 361-362 |
| Micro-Porta-Agujas TITE GRIP | 338-339 |
| Micro-tijeras | 62-67 |
| Micro-tijeras de disección | 65 |
| MIDDELDFORF Separadores | 243 |
| MIKULICZ Pinzas-clamps para peritoneo | 192-193 |
| MIKULICZ Separadores para cirugía profunda | 255 |
| MIKULICZ-BABY Pinza-clamp para peritoneo | 192 |
| MILAN Cureta para biopsia endo-cerviz | 460 |
| MILLER Escofinas | 592 |
| MILLER Laringoscopios | 28-31 |
| MILLER TITE GRIP Escofinas | 596 |
| MILLER-SENN Separadores | 226 |
| MILLESÍ Micro-tijeras | 64 |
| MILLIGAN Disecador para dura-madre | 698 |
| MILLIN Dilatador para el cuello vesical | 423 |
| MILLIN Pinza capsular | 423 |
| MILLIN Pinza para coger los lóbulos anteriores | 423 |
| MILLIN Pinza porta-ligaduras supra-pubiana | 423 |
| MILLIN Separadores para la vejiga | 310 |
| MILLIN-YOUNG Porta-agujas de bumerang | 372 |
| MINI-HOHMANN Elevadores para huesos | 576 |
| MINI-KERN Pinza para huesos | 625 |
| MINI-LAMBOTTE Osteótomos | 608 |
| MINI-LANGENBECK Separadores | 224 |
| MINI-LEXER Gubias | 612 |
| MINI-LEXER Osteótomos | 612 |
| MINI-STILLE Cizalla para escayolas | 677 |
| MINI-YASARGIL Clips vasculares | 154 |
| MINI-YASARGIL Pinzas para aplicar clips vasculares | 154 |
| MIOTTI-OVERHOLT Pinzas de disección y ligaduras | 185 |
| MIXTER Pinza para los cálculos biliar | 419 |
| MIXTER Pinzas de disección y ligaduras | 182, 188-189 |
| MIXTER Tijeras para cirugía | 79 |
| MIXTER-BABY Pinzas de disección y ligaduras | 180 |
| MIXTER-GEMINI Pinzas de disección y ligaduras | 181 |
| MIXTER-O'SHAUGNESSY Pinza de disección y ligaduras | 182 |

| | |
|---|--------------|
| MIXTER-OVERHOLT Pinza de disección y ligaduras | 183 |
| MIXTER-PAUL (HEISS) Pinza de disección y ligaduras | 182 |
| MOBERG Separadores | 224 |
| MOD. BONN Pinzas finas quirúrgicas | 138 |
| MOD. CANAD. Bisturíes para menisco | 643 |
| MOD. KÖLN Pinza hemostática para cuero cabelludo | 691 |
| MOD. MÜNCHEN Cureta para biopsia endo-uterina | 459 |
| MOD. RUSS. Pinzas para vasos y tumores | 149 |
| MOD. SWITZERLAND Micro-pinzas (modelos de relojero) | 120 |
| MOD. TÜBINGEN VANNAS Micro-tijeras | 62 |
| MOD. USA Cucharillas cortantes | 601 |
| MOD. USA Pinzas de disección | 133 |
| MOD. USA Pinzas quirúrgicas | 145 |
| MOD. USA Separador para escayolas | 682 |
| MOD. USA Tijera umbilical | 108 |
| MOD. WIENER Porta-ligadura | 378 |
| MOGEN Instrumento para circuncisión | 426 |
| MOLDESTAD Separador para venas | 217 |
| MÖLTGEN Goniómetro para extremidades | 7 |
| Mondador de tendones | 646 |
| MOORE Cucharilla para la vesícula biliar | 417 |
| MOORE-STAUDE Pinza para coger el cuello del útero | 452 |
| MORGAN-TISCHLER Pinza saca-bocados para biopsia | 464 |
| MORRIS-DE BAKEY ATRAUMATIC-GRIP Pinzas-clamps para aorta | 540 |
| MORSE Separador para esternotomía | 499 |
| MOSQUITO-BABY Pinzas hemostáticas finas | 164 |
| MOSQUITO-HALSTED Pinzas hemostáticas finas | 164-165, 170 |
| MOSQUITO-HALSTED-DE BAKEY ATRAUMATIC-GRIP Pinzas hemostáticas finas | 165 |
| MOTT-PARKER Separadores | 228 |
| MOYNIHAN Pinzas hemostáticas | 178 |
| MOYNIHAN Sonda y cucharilla para los cálculos biliares | 415 |
| MÜHLING (KILLIAN) Tijera para el tabique nasal | 102 |
| MÜHLING Periostótomos | 584 |
| MÜLLER Aproximadores | 158 |
| MÜLLER-BIEMER Aproximadores | 157 |
| MÜLLER-VERBRUGGE Elevadores para huesos | 579 |
| MUMMERY-LOCKHART Sondas para fistulas | 314 |
| MÜNCHEN MOD. Cureta para biopsia endo-uterina | 459 |
| MURLESS Elevador para cabeza | 481 |
| MURPHY Cinta | 10 |
| MURPHY-LANE Elevador para luxación | 581 |
| MURRAY-CRILE Porta-agujas | 366 |
| MUSEUX Pinzas para coger el cuello útero | 456 |
| MYERS Sondas para várices | 315 |

N

| | |
|--|-----|
| NABATOFF Juego para várices | 315 |
| NAEGLE Fórceps | 478 |
| NAGEL Micro-tijeras | 67 |
| NEFF Bisturíes para menisco | 642 |
| NEGUS Pinzas hemostáticas y para amígdalas | 179 |
| NEIVERT Porta-agujas | 363 |
| NEIVERT TITE GRIP Porta-agujas | 342 |
| NEIVERT-COTTLE Gancho para las coanas | 221 |
| NELATON Sonda acanalada | 314 |
| NELSON Pinza quirúrgica | 148 |
| NELSON Trocares para hidrocele y punción abdominal | 318 |
| NELSON-METZENBAUM Tijeras de disección | 91 |
| NELSON-METZENBAUM Tijeras DURACUT de disección | 53 |
| NEW ORLEANS Porta-agujas | 367 |
| NEW ORLEANS TITE GRIP Porta-agujas | 344 |
| NEWS Separador para la tráquea | 217 |
| NOBLE-MAYO Tijeras de disección | 86 |
| NORTHBENT (SPENCER) Tijeras para ligaduras | 352 |
| NOTO Pinza para pólipos uterinos y ovarios | 457 |
| NOTT Espéculos vaginales | 433 |
| NOVAK Cureta aspiradora para biopsia endo-uterina | 459 |

O

| | |
|--|-----|
| O'BRIEN Tijera para ligadura | 352 |
| O'CONNOR Gancho para piel | 217 |
| O'CONNOR-O'SULLIVAN Separador abdominal | 304 |
| O'SHAUGNESSY-MIXTER Pinza de disección y ligaduras | 182 |
| O'SULLIVAN-O'CONNOR Separador abdominal | 304 |

| | |
|---|----------|
| OBWEGESER Pinza de ligadura TITE GRIP | 113 |
| OBWEGESER Separadores para tejido blando | 241 |
| OCHSNER ATRAUMATIC-GRIP Pinza-clamp para aorta | 539 |
| OCHSNER Pinza para ligadura | 152 |
| OCHSNER Sonda para el conducto biliar | 415 |
| OCHSNER Trócares para vesícula biliar | 318 |
| OCHSNER-ALLIS Pinza intestinal y para tejidos | 383 |
| OCHSNER-DIXON (CRILE-RANKIN) Pinzas hemostáticas finas | 167 |
| OCHSNER-KOCHER Pinzas hemostáticas | 177 |
| OCHSNER-ROCHESTER Pinzas hemostáticas | 178 |
| OEHLER Pinzas TITE GRIP | 118 |
| OLDBERG Pinza para hipófisis | 719 |
| OLIVECRONA (GIGLI) Sierras de hilo | 687 |
| OLIVECRONA Disecadores para dura-madre | 700 |
| OLIVECRONA Espátulas cerebrales | 706 |
| OLIVECRONA Tijera para nervio trigémino | 100 |
| OLIVECRONA-TOENNIS (SCOVILLE) Pinza para colocar grapas | 690 |
| OLLIER Separador | 236 |
| OLSEN-HEGAR Porta-agujas con tijera | 370 |
| OLSEN-HEGAR TITE GRIP Porta-agujas | 348 |
| OLSEN-HEGAR-BABY TITE GRIP Porta-agujas | 348 |
| OMBREDANNE Martillo | 621 |
| Osteótomos | 607-614 |
| Osteótomos, hojas intercambiables | 611 |
| OVERHOLT Pinzas de disección y ligaduras | 183, 185 |
| OVERHOLT-BABY Pinza de disección y ligaduras | 183 |
| OVERHOLT-GEISSENDOERFER Pinzas de disección y ligaduras | 184 |
| OVERHOLT-MIOTTI Pinzas de disección y ligaduras | 185 |
| OVERHOLT-MIXTER Pinza de disección y ligaduras | 183 |

P

| | |
|--|--------------|
| PACIFIC-KEVOURKIAN Pinza saca-bocados para biopsia | 464 |
| Palanganas | 749 |
| PARK-ALAN Separador para el recto | 408 |
| PARKER Separadores | 228 |
| PARKER-LANGENBECK (US-ARMY) Separadores | 231 |
| PARKER-MOTT Separadores | 228 |
| PASQUE EUFRATE TITE GRIP Porta-agujas | 344 |
| PAUFIQUE Pinza fina quirúrgica | 139 |
| PAUL Separador para vainas tendinosas | 225 |
| PAUL-MIXTER (HEISS) Pinza de disección y ligaduras | 182 |
| PAYR Agujas vasculares | 354 |
| PAYR Pinzas-clamps intestinales y estomacales | 403 |
| PAYR Sondas conductoras | 377 |
| PAYR-BABY Pinzas-clamps intestinales y estomacales | 403 |
| PEAN Pinzas hemostáticas | 173-174 |
| PEAN-DE BAKEY ATRAUMATIC-GRIP Pinzas-clamps vasculares | 529 |
| PEAN-DE BAKEY ATRAUMATIC-GRIP Pinzas hemostáticas | 176 |
| PEAN-ROCHESTER Pinzas hemostáticas | 175 |
| PEDERSON Espéculos vaginales | 432 |
| PEDERSON Espéculos vaginales para la cirugía con laser | 433 |
| PEERS Pinza de campo | 202 |
| PEET Pinza para espinas | 151 |
| PEET Pinzas para espinas TITE GRIP | 151 |
| PELTESON Porta-algodones | 317 |
| Pelvímetro | 477 |
| PENFIELD Disecadores para dura-madre | 699 |
| PENNINGTON Pinzas intestinales y para tejidos | 387 |
| PERCY Retractores para amputación | 571 |
| PERFECT-GRIP Micro-pinzas de agarre | 124 |
| PERFECT-GRIP Micro-pinzas de ligadura | 123 |
| PERFECT-GRIP Micro-Porta-agujas | 359, 361-362 |
| PERFECT-GRIP Porta-agujas | 364 |
| PERFECT-GRIP TITAN-LINE Porta-agujas | 365 |
| Perfora-cráneos | 485 |
| Perforador de mano | 651-653 |
| Perforadores iniciales | 689 |
| Periostótomos | 582-591 |
| Periostótomos costales | 495-497 |
| PERMAN Separador abdominal | 299 |
| PERTHES Escariadores | 650 |
| PHANEUF Pinza-clamp para histerectomía | 194 |
| PIERCE Cánula para punción del seno maxilar | 319 |
| Piezas de conexión | 333 |
| Piezas de repuesto para la sierra oscilante | 681 |
| PIFFARD Curetas para lupus | 20 |
| PINARD Estetoscopio | 5 |

| | |
|---|---|
| Pinzas agarre de tejidos | 148 |
| Pinzas agarre del pulmón | 149 |
| Pinzas aproximadoras sin porta-clips | 378 |
| Pinzas auriculares y nasales | 136-137 |
| Pinzas capsular | 423 |
| Pinzas cierra-hilos TITE GRIP | 662 |
| Pinzas clipadoras | 690 |
| Pinzas conductora para catéteres | 473 |
| Pinzas cortantes para huesos | 494, 637-639 |
| Pinzas cortantes para laminectomía | 707-719 |
| Pinzas corta-uñas | 17, 645 |
| Pinzas cuticulares | 17 |
| Pinzas de agarre | 149 |
| Pinzas de agarre para tejido y tumor | 126-127 |
| Pinzas de campo | 200-202 |
| Pinzas de disección | 132-134, 180-189 |
| Pinzas de disección TITE GRIP | 113-115 |
| Pinzas de disección y ligaduras | 180-189, 564 |
| Pinzas de disección y ligaduras ATRAUMATIC-GRIP | 186 |
| Pinzas de ligadura TITE GRIP | 113 |
| Pinzas de torácica y ligadura | 564 |
| Pinzas de tracción craneal | 689 |
| Pinzas depilatorias | 152 |
| Pinzas DIU (Dispositivo Intra-Uterino) | 447 |
| Pinzas finas de disección | 128-131 |
| Pinzas finas quirúrgicas | 138-143 |
| Pinzas gubias | 494 |
| Pinzas hemostáticas | 164-179 |
| Pinzas hemostáticas ATRAUMATIC-GRIP | 176 |
| Pinzas hemostáticas finas | 164-172 |
| Pinzas hemostáticas finas ATRAUMATIC-GRIP | 165, 167 |
| Pinzas hemostáticas finas TITAN-LINE | 166, 168 |
| Pinzas hemostáticas para cuero cabelludo | 691 |
| Pinzas intestinales | 149 |
| Pinzas intestinales y para tejidos | 383-389 |
| Pinzas intestinales y para tejidos ATRAUMATIC-GRIP | 389 |
| Pinzas intestinales y para tejidos TITE GRIP | 388 |
| Pinzas para aborto | 482-483 |
| Pinzas para agarrar el tendón | 647 |
| Pinzas para amígdalas | 179 |
| Pinzas para anastomosis del recto | 400-401 |
| Pinzas para anastomosis del recto ATRAUMATIC-GRIP | 400-401 |
| Pinzas para aplicar aproximadores | 158 |
| Pinzas para aplicar clips vasculares | 154-156 |
| Pinzas para aplicar y quitar clips hemostáticas | 691 |
| Pinzas para cerrar los clamps | 402 |
| Pinzas para coger el cuello del útero | 452-456 |
| Pinzas para coger los lóbulos anteriores | 423 |
| Pinzas para colocar grapas | 690 |
| Pinzas para desechos | 735 |
| Pinzas para disección y ligaduras ATRAUMATIC-GRIP | 551 |
| Pinzas para el útero | 458 |
| Pinzas para entrelazar tendones | 649 |
| Pinzas para espinas | 150-151 |
| Pinzas para espinas TITE GRIP | 151 |
| Pinzas para esterilización | 734 |
| Pinzas para extraer alambres | 663-664 |
| Pinzas para extraer alambres TITE GRIP | 663 |
| Pinzas para fijar el cordón espermático | 425 |
| Pinzas para fragmentos pequeños | 622 |
| Pinzas para hipófisis | 719 |
| Pinzas para huesos | 493, 624-629 |
| Pinzas para introducir catéteres | 32 |
| Pinzas para la aurícula atril | 564 |
| Pinzas para la reducción maxilar | 622 |
| Pinzas para la vejiga amniótica | 477 |
| Pinzas para ligaduras | 152, 180-189 |
| Pinzas para los cálculos biliares | 418-419 |
| Pinzas para los cálculos renales | 420-421 |
| Pinzas para menisco y cartilago | 640 |
| Pinzas para microscopia | 121 |
| Pinzas para pasar tendones | 649 |
| Pinzas para pericráneo | 481 |
| Pinzas para placenta | 482-483 |
| Pinzas para pólipos uterinos y ovarios | 457 |
| Pinzas para poner agrafes | 379 |
| Pinzas para poner y quitar agrafes | 379 |
| Pinzas para poner y quitar TITAN-LINE clamps Bulldog | 160 |
| Pinzas para quitar agrafes | 379 |
| Pinzas para reducción | 622-623 |
| Pinzas para romper escayolas | 682 |
| Pinzas para rotula | 623 |
| Pinzas para secuestro | 623 |
| Pinzas para senos | 204 |
| Pinzas para sostener el riñón | 421 |
| Pinzas para sujetar y romper hojas de afeitar | 36 |
| Pinzas para tapones | 208 |
| Pinzas para tejidos y tirar uñas TITE GRIP | 116 |
| Pinzas para torundas y esponjas | 209-210 |
| Pinzas para tubos | 203 |
| Pinzas para vasos y tumores | 148-149 |
| Pinzas para vendajes y torundas | 204-207 |
| Pinzas pasadoras | 517 |
| Pinzas patente de conducto ATRAUMATIC-GRIP | 531, 556 |
| Pinzas porta-huesos | 630 |
| Pinzas porta-laminillas | 152 |
| Pinzas porta-ligaduras supra-pubiana | 423 |
| Pinzas quirúrgicas | 144-148 |
| Pinzas quirúrgicas TITE GRIP | 117-118 |
| Pinzas saca-bocado craneal | 688 |
| Pinzas saca-bocado para biopsia | 460-465 |
| Pinzas saca-bocado para biopsia rectal | 412 |
| Pinzas tira-lenguas | 23 |
| Pinzas TITE GRIP | 118 |
| Pinzas vasculares ATRAUMATIC GRIP | 135 |
| Pinzas-clamps bronquiales | 566 |
| Pinzas-clamps bronquiales ATRAUMATIC-GRIP | 552 |
| Pinzas-clamps de presión progresiva | 409 |
| Pinzas-clamps de varias aplicaciones ATRAUMATIC-GRIP | 520-523, 530, 553-556 |
| Pinzas-clamps estomacales | 403 |
| Pinzas-clamps estomacales ATRAUMATIC-GRIP | 397 |
| Pinzas-clamps intestinales | 390-396, 403 |
| Pinzas-clamps intestinales ATRAUMATIC-GRIP | 391, 395-396 |
| Pinzas-clamps intestinales y estomacales | 403 |
| Pinzas-clamps intestinales y para anastomosis | 402 |
| Pinzas-clamps oclusiva inferior ATRAUMATIC-GRIP | 399 |
| Pinzas-clamps oclusiva superior ATRAUMATIC-GRIP | 398 |
| Pinzas-clamps para anastomosis (vena cava) | 565 |
| Pinzas-clamps para anastomosis ATRAUMATIC-GRIP | 520-523, 542-544, 548-549, 559-560 |
| Pinzas-clamps para anastomosis de aorta ATRAUMATIC-GRIP | 548-549 |
| Pinzas-clamps para aneurisma de aorta ATRAUMATIC-GRIP | 545-547, 561 |
| Pinzas-clamps para aorta ATRAUMATIC-GRIP | 537-540, 561 |
| Pinzas-clamps para arteria renal ATRAUMATIC-GRIP | 537 |
| Pinzas-clamps para arterias renales ATRAUMATIC-GRIP | 558 |
| Pinzas-clamps para carótida ATRAUMATIC-GRIP | 524, 537 |
| Pinzas-clamps para coarctación ATRAUMATIC-GRIP | 532-533, 557 |
| Pinzas-clamps para hemorroides | 410 |
| Pinzas-clamps para histerectomía | 194-197 |
| Pinzas-clamps para histerectomía ATRAUMATIC-GRIP | 197 |
| Pinzas-clamps para iliaca ATRAUMATIC-GRIP | 558 |
| Pinzas-clamps para la pediatría ATRAUMATIC-GRIP | 555 |
| Pinzas-clamps para la profunda ATRAUMATIC-GRIP | 534 |
| Pinzas-clamps para músculos | 728 |
| Pinzas-clamps para oclusión tangencial ATRAUMATIC-GRIP | 541, 562 |
| Pinzas-clamps para pedúnculo renal | 191 |
| Pinzas-clamps para peritoneo | 192-193 |
| Pinzas-clamps para renal | 190 |
| Pinzas-clamps para renal ATRAUMATIC-GRIP | 190 |
| Pinzas-clamps para vasos periféricos ATRAUMATIC-GRIP | 534-536, 558 |
| Pinzas-clamps para vena cava ATRAUMATIC-GRIP | 550 |
| Pinzas-clamps uterina para hemostasis | 481 |
| Pinzas-clamps vasculares ATRAUMATIC-GRIP | 520-523, 530, 534, 537, 555-556, 558, 561-562 |
| Pinzas-clamps vasculares semi-flexibles | 563 |
| Pinzas-conductoras de tendón | 648 |
| Pinzas-gubias | 631-636 |
| Pinzas-guías para taladros | 650 |
| PIPER Fórceps | 480 |
| Pipeta de vidrio | 473 |
| Pisón | 606 |
| Pistola-lavatoria de chorro de agua | 754-755 |
| Placas de identificación de color | 743 |
| PLESTER Separadores con retenida automática | 275 |
| POOLE Tubos para aspiración | 325 |
| Porta-agujas | 363, 366-371 |
| Porta-agujas con tijera | 370 |

| | |
|--|--------------|
| Porta-agujas de bumerang | 372 |
| Porta-agujas para zurdos TITE GRIP | 341 |
| Porta-agujas PERFECT-GRIP | 364 |
| Porta-agujas PERFECT-GRIP micro | 359, 361-362 |
| Porta-agujas PERFECT-GRIP TITAN-LINE | 365 |
| Porta-agujas TITE GRIP | 340-350 |
| Porta-agujas TITE GRIP micro | 338-339 |
| Porta-agujas-micro | 358-362 |
| Porta-algodón y -tapónes | 473 |
| Porta-algodones | 316-317, 409 |
| Porta-clamp | 402 |
| Porta-grapas | 690-691 |
| Porta-hoja micro-bisturí | 473 |
| Porta-instrumentos | 736-737 |
| Porta-ligadura | 378 |
| Porta-placas | 743 |
| POTTS-DE BAKEY ATRAUMATIC-GRIP Pinzas patente de conducto | 531 |
| POTTS-SMITH Pinzas de disección TITE GRIP | 114 |
| POTTS-SMITH Pinzas finas de disección | 131 |
| POTTS-SMITH Pinzas finas quirúrgicas | 143 |
| POTTS-SMITH Tijera de disección | 98 |
| POTTS-SMITH Tijeras DURACUT vasculares | 56 |
| POTTS-SMITH Tijeras vasculares | 96-97 |
| POZZI Pinza para coger el cuello del útero | 453 |
| PRATT Espéculo para el recto | 405 |
| PRATT Pinzas para coger el cuello útero | 455 |
| PRATT Sondas para fístula (gancho para cripta) | 409 |
| PREP LUBE Detergente para instrumentos | 733 |
| PRESBYTERIAN Pinza para tubos | 203 |
| PRICE-THOMAS Pinzas-clamps bronquiales | 566 |
| PROVIDENCE-HOSPITAL Pinzas hemostáticas finas | 168 |
| PUTTI Escofinas | 594 |
| PYNCHON-ANDREW Tubos para aspiración | 325 |

Q

| | |
|--|-----|
| QUERVAIN Elevador | 575 |
| QUINBY Tijera para encías | 94 |
| QUINKE Agujas para punción lumbar | 328 |

R

| | |
|--|---------|
| RABINER Martillos de percusión | 3 |
| RADOLF Pinza arranca-uñas | 645 |
| RAGNELL Tijeras DURACUT de disección | 49 |
| RAGNELL Tijeras para la cirugía y disección | 83 |
| RAGNELL-DAVIS Gancho para cirugía plástica | 226 |
| RALK Perforador de mano | 653 |
| RALKS (VIRTUS) Pinza para espinas | 151 |
| RAMPLEY Pinzas para torundas y esponjas | 210 |
| RANDALL Cureta aspiradora para biopsia endo-uterina | 459 |
| RANDALL Pinzas para los cálculos renales | 420-421 |
| RANEY Pinza hemostática para cuero cabelludo | 691 |
| RANEY Pinza para aplicar y quitar clips hemostáticas | 691 |
| RANEY Porta-grapas | 691 |
| RANKIN-CRILE (OCHSNER-DIXON) Pinzas hemostáticas finas | 167 |
| RANKIN-CRILE-DE BAKEY Pinzas hemostáticas finas ATRAUMATIC-GRIP | 167 |
| RANKIN-KELLY Pinzas hemostáticas finas | 169 |
| RAY Curetas | 692 |
| RECAMIER Curetas para aborto y placenta | 484 |
| RECAMIER Curetas uterinas | 468 |
| Recipientes | 747 |
| REDO Pinzas-clamps intestinales | 390 |
| REDON Agujas de guía | 334 |
| Reglas | 6 |
| REINER Cuchillo para escayolas | 679 |
| RESANO ATRAUMATIC-GRIP Pinza para anastomosis del recto | 401 |
| Retractores para amputación | 571 |
| REVERDIN Agujas | 373 |
| REVERDIN Espátula abdominal e intestinal | 267 |
| REYNOLDS Tijeras finas de disección | 93 |
| REYNOLDS-COOLEY ATRAUMATIC-GRIP Pinzas-clamps para anastomosis | 559 |
| REYNOLDS-DE BAKEY ATRAUMATIC-GRIP Pinzas-clamps para anastomosis | 542 |
| REZEK-HEANEY Pinza-clamp para histerectomía | 196 |

| | |
|---|---------|
| RICARD Separadores abdominales | 298 |
| RICHARDSON Separadores | 251 |
| RICHARDSON-EASTMAN Separadores | 250 |
| RICHTER Tijera para operaciones | 80 |
| RICHTER-HEATH Pinza para quitar agrafes | 379 |
| RIENHOFF-FINOCHIETTO Separador costal | 506 |
| ROBB Espátulas y dilatadores para la íntima | 512 |
| ROBERTS Pinzas hemostáticas | 178 |
| ROBSON-MAYO ATRAUMATIC-GRIP Pinzas-clamps intestinales | 396 |
| ROBSON-MAYO Pinzas-clamps intestinales | 396 |
| ROCHARD Bastidores para la fijación a las barras laterales | 309 |
| ROCHARD Separadores abdominales | 309 |
| ROCHESTER-CARMALT Pinzas hemostáticas | 178 |
| ROCHESTER-OCHSNER Pinzas hemostáticas | 178 |
| ROCHESTER-PEAN Pinzas hemostáticas | 175 |
| Rodillo para tubos | 203 |
| ROEDER Pinza de campo | 201 |
| ROGERS (HEANEY-DE BAKES) ATRAUMATIC-GRIP Pinzas-clamps para histerectomía | 197 |
| ROGERS (WERTHEIM-DE BAKEY) ATRAUMATIC-GRIP Pinzas-clamps parametrium | 197 |
| ROGGE Pinza para esterilización | 734 |
| ROLLET Separador | 218 |
| ROSCHKE Separador para el recto | 407 |
| ROSE Separadores | 227 |
| ROSEGGER-KLIMA Agujas | 518 |
| ROSEGGER-KLIMA Agujas para la punción del esternón | 329 |
| ROSEN Cánulas para aspiración | 320 |
| ROSER-KÖNIG Abre-boca | 22 |
| RÖTTGEN-RUSKIN Pinza-gubia | 636 |
| ROUX Separadores | 229 |
| ROUX-BABY Separadores | 228 |
| RUDD Ligador para hemorroides | 410 |
| RUMEL Pinzas de disección y ligaduras | 186 |
| RUMEL-BELMONT Torniquetes | 518 |
| RUMEL-DE BAKEY ATRAUMATIC-GRIP Pinzas de disección y ligaduras | 186 |
| RUSKIN Pinzas cortantes para huesos | 638 |
| RUSKIN Pinzas-gubias | 633-634 |
| RUSKIN-LISTON Pinzas cortantes para huesos | 638 |
| RUSKIN-RÖTTGEN Pinza-gubia | 636 |
| RUSKIN-STILLE Pinza-gubia | 636 |
| RUSS. MODELL Pinzas para vasos y tumores | 149 |
| RUST Sierra para amputación y resección | 573 |
| RYDEL-SEIFFER Diapasón | 4 |
| RYDER TITE GRIP Micro-Porta-agujas | 340 |
| RYDER-LANGENBECK TITE GRIP Porta-agujas | 350 |
| RYDER-VASCULAR TITE GRIP Micro-Porta-agujas | 340 |

S

| | |
|--|-----|
| SAALFELD Saca-comedones | 19 |
| Saca-comedones | 19 |
| SACHS Disecadores para dura-madre | 698 |
| SACHS Gancho para dura-madre | 217 |
| SACHS Gancho para fístulas | 221 |
| SACHSE Meatótomo | 426 |
| SAENGER Pinzas para aborto y placenta | 483 |
| SALENIUS Bisturíes para menisco | 642 |
| SALING Amnioscopios | 472 |
| SALING Amnioscopios para la micro-extracción de sangre | 472 |
| SAMII Pinza de agarre para tejido y tumor | 127 |
| SAMII-YASARGIL Pinza de agarre para tejido y tumor | 126 |
| SANVENERO Tijeras para la cirugía plástica | 70 |
| SAROT Pinzas hemostáticas finas | 171 |
| SAROT Pinzas-clamps bronquiales | 566 |
| SAROT TITE GRIP Porta-agujas | 344 |
| SATINSKY Pinzas-clamps para anastomosis (vena cava) | 565 |
| SATINSKY Tijera para la vena cava | 99 |
| SATINSKY-BABY Pinza-clamp para anastomosis (vena cava) | 565 |
| SATINSKY-DE BAKEY ATRAUMATIC-GRIP Clamps Bulldog | 525 |
| SATINSKY-DE BAKEY ATRAUMATIC-GRIP Pinzas-clamps para oclusión tangencial | 541 |
| SATTERLEE Sierra para amputación y resección | 572 |
| SAUER Pinza fina quirúrgica | 138 |
| SAUERBRUCH Costótomo | 492 |
| SAUERBRUCH Estuches para esterilizar agujas | 357 |
| SAUERBRUCH Pinza para desechos | 735 |

| | | | |
|--|-----------------------|---|------------------------|
| SAUERBRUCH Separadores | 242 | Separadores para la fijación a la mesa de operaciones | 704 |
| SAUERBRUCH-FREY Costótomo | 493 | Separadores para la fijación del cráneo | 702-705 |
| SAUERBRUCH-SCHNEIDER Perióstótomo | 588 | Separadores para la glándula tiroidea | 243 |
| SCALP CONTOUR Separadores con retenida automática | 276 | Separadores para la prostata | 422 |
| SCHAAF Pinza depilatoria | 152 | Separadores para la raíz de nervios | 701 |
| SCHÄDEL Pinzas de campo | 200 | Separadores para la salida de cabeza | 481 |
| SCHAMBERG Saca-comedones | 19 | Separadores para la tráquea | 728 |
| SCHEDE Cucharillas cortantes | 602 | Separadores para la vejiga | 310 |
| SCHERBACK Espéculos vaginales | 442 | Separadores para la vulva | 281 |
| SCHINK Dermátomo | 41 | Separadores para laminectomía | 276, 279-280, 284, 286 |
| SCHMID Cánulas vasculares para irrigación | 322 | Separadores para párpados | 222 |
| SCHMID Espátulas para la íntima | 513 | Separadores para pelvis | 256-258 |
| SCHMIEDEN Sonda conductora | 378 | Separadores para píloro | 403 |
| SCHMIEDEN-TAYLOR Tijera para dura-madre | 100 | Separadores para rodilla | 641 |
| SCHNEIDER Perióstótomo | 588 | Separadores para scápula | 260 |
| SCHNEIDER-SAUERBRUCH Perióstótomo | 588 | Separadores para tejido blando | 241 |
| SCHNIDT Pinzas hemostáticas y para amígdalas | 179 | Separadores para tráquea | 217, 219-220 |
| SCHOEMAKER-LOTH Tijera para ligadura | 352 | Separadores para vainas tendinosas | 225 |
| SCHRÖDER Cucharillas uterinas | 466 | Separadores para venas | 217, 222-223 |
| SCHRÖDER Pinzas para coger el cuello del útero | 452, 454 | Separadores para venas (separadores para párpados) | 222 |
| SCHUBERT Pinzas saca-bocados para biopsia | 461 | Separadores profundo para mano y antebrazo | 271 |
| SCHULTZE Salpingógrafos | 474 | Separadores torácico | 507 |
| SCHUMACHER Pinzas saca-bocados para biopsia | 463 | Separadores y contractor costal | 508 |
| SCHUMACHER Tijera umbilical | 108 | Separadores y separadores para huesos | 232 |
| SCHWARTZ Clips vasculares | 155 | Separadores abdominales | 248-249 |
| SCHWARTZ Pinzas para aplicar clips vasculares | 155 | SEUTIN Tijera para tela, cizalla para escayolas | 675 |
| SCOVILLE (OLIVECRONA-TOENNIS) Pinza para colocar grapas | 690 | SEWALL Perióstótomo | 582 |
| SCOVILLE Ganchos para separadores | 287 | SHAMBAUGH Ganchos para la microcirugía | 212 |
| SCOVILLE Separadores para la raíz de nervios | 701 | SIEBOLD Tijera uterina | 106 |
| SCOVILLE Separadores para laminectomía | 286 | SIEBOLD-SIMS Tijera uterina | 106 |
| SCOVILLE Valvas laterales para separadores | 287 | Sierra oscilante para escayolas | 680 |
| SCOVILLE-HAVERFIELD Separador para laminectomía | 286 | Sierras de hilo | 687 |
| SCUDDER ATRAUMATIC-GRIP Pinzas-clamps estomacales | 397 | Sierras para abrir anillos | 645 |
| SEALY Tijeras finas para cirugía | 68 | Sierras para amputación y resección | 572-573 |
| SEBILEAU Elevador | 575 | Sierras para escayolas | 679 |
| Seda para sutura | 353 | SILVER Dermátomo para hojas de afeitar corrientes | 41 |
| SEDILLOT Perióstótomos | 586 | SIMON Cucharillas cortantes | 605 |
| SEGOND Pinzas-clamps para histerectomía | 195-196 | SIMON Cucharillas uterinas | 466 |
| SEIFFER-RYDEL Diapasón | 4 | SIMON Gancho para fístulas | 221 |
| SELETZ-GELPI Separador para la vulva | 281 | SIMON Separadores para cirugía profunda | 254 |
| SELLHEIM Separador para la salida de cabeza | 481 | SIMON-HEANEY Separador para cirugía profunda | 254 |
| SELLORS Separador y contractor costal | 508 | SIMPSON Histerómetros | 446 |
| SEMB Perióstótomos costales | 496 | SIMPSON-BRAUN Fórceps | 478 |
| SEMB Pinza cortante para huesos | 494 | SIMS Curetas uterinas | 467 |
| SEMB Pinza gubia | 494 | SIMS Espéculos para el recto | 405-406 |
| SEMB Pinzas de disección y ligaduras | 564 | SIMS Espéculos vaginales | 438 |
| SEMB Pinzas para huesos | 493 | SIMS Histerómetros | 446 |
| SEMB Separadores para el pulmón | 260 | SIMS Tijeras DURACUT uterinas | 60 |
| SEMKEN Pinza de disección TITE GRIP | 113 | SIMS Tijeras uterinas | 104-105 |
| SEMKEN Pinza quirúrgica TITE GRIP | 117 | SIMS-MAIER Pinzas para vendajes y torundas | 205 |
| SEMKEN Pinzas finas de disección | 130 | SIMS-SIEBOLD Tijera uterina | 106 |
| SEMKEN Pinzas finas quirúrgicas | 142 | SINGLEY (TUTTLE) Pinzas agarre del pulmón | 149 |
| SEMM Espéculos vaginales | 432 | SMELLIE Perfora-cráneos | 485 |
| SEMM Separador abdominal | 305 | SMILLIE Bisturries para menisco | 643 |
| SENN-GREEN Separadores | 224 | SMILLIE Separadores para rodilla | 641 |
| SENN-MILLER Separadores | 226 | SMITH Tijeras para vendajes | 672 |
| Separadores | 212, 216-265 | SMITH-BUIE Separador para el recto | 408 |
| Separadores abdominales | 297-309 | SMITH-CUSHING-FERRIS Pinzas cortantes para laminectomía | 713 |
| Separadores atrium | 509 | SMITH-FERRIS Pinzas quirúrgicas | 147 |
| Separadores con retenida automática | 270-276, 278, 282-283 | SMITH-HEYWOOD Pinza para pólipos uterinos y ovarios | 457 |
| Separadores costales | 500-508 | SMITH-HEYWOOD Pinza tira-lengua | 23 |
| Separadores de mano y túnel de carpo | 271 | SMITH-KERRISON-FERRIS Pinzas cortantes para laminectomía | 709-710, 712 |
| Separadores espinales | 231 | SMITH-POTTS Pinza fina de disección | 131 |
| Separadores para apendectomía | 284 | SMITH-POTTS Pinzas de disección TITE GRIP | 114 |
| Separadores para bocio | 224 | SMITH-POTTS Pinzas finas quirúrgicas | 143 |
| Separadores para cirugía profunda | 252-259 | SMITH-POTTS Tijeras de disección | 98 |
| Separadores para cuerpos vertebrales | 296 | SMITH-POTTS Tijeras DURACUT vasculares | 56 |
| Separadores para dedos | 271 | SMITH-POTTS Tijeras vasculares | 96-97 |
| Separadores para dedos y pequeñas heridas | 271 | SOFT-GREGORY ATRAUMATIC-GRIP Clamps Bulldog | 527 |
| Separadores para el pulmón | 260 | SOMER Pinza para el útero | 458 |
| Separadores para el recto | 407-408 | Sondas | 312-314, 450-451 |
| Separadores para escayolas | 682 | Sondas abotonadas | 312-313, 694 |
| Separadores para esternotomía | 498-499 | Sondas con oje | 313 |
| Separadores para hemi-laminectomía | 277 | Sondas conductoras de plástico | 378 |
| Separadores para hilares | 223 | Sondas conductoras | 377-378 |
| Separadores para huesos | 232 | Sondas dobles | 694 |
| Separadores para la cirugía lumbar vertebral | 294 | Sondas forma mirto | 313 |
| Separadores para la columna cervical | 285, 290-292 | Sondas metálicas | 424 |
| Separadores para la columna vertebral | 288 | | |

| | |
|--|----------|
| Sondas para bocio..... | 378 |
| Sondas para el conducto biliar..... | 415 |
| Sondas para el recto..... | 409 |
| Sondas para endarterectomía..... | 514 |
| Sondas para fistula (gancho para cripta)..... | 409 |
| Sondas para medir..... | 450 |
| Sondas para medir la profundidad..... | 451 |
| Sondas para várices..... | 315 |
| Sondas y cucharilla para los cálculos biliares..... | 415 |
| SPENCER (NORTHBENT) Tijeras para ligaduras..... | 352 |
| SPENCER Tijeras para ligadura..... | 352 |
| SPENCER-WELLS Pinzas hemostáticas..... | 173 |
| SPRATT Cucharillas cortantes..... | 602 |
| SPURLING Pinzas cortantes para laminectomía..... | 717 |
| ST. MARKS Separadores para pelvis..... | 258 |
| ST. MARTIN Pinza fina quirúrgica..... | 139 |
| STADLER-BRAUN Tijera para perineo (episiotomía)..... | 107 |
| STANDARD-YASARGIL Clips vasculares..... | 154 |
| STANDARD-YASARGIL Pinzas para aplicar clips vasculares..... | 154 |
| STAUDE-MOORE Pinza para coger el cuello del útero..... | 452 |
| STEINMANN Clavos..... | 654 |
| STEINMANN Pinza para agarrar el tendón..... | 647 |
| STELLBRING Pinzas-gubias..... | 632 |
| STELZNER (CRAFOORD) Tijera para lobectomía y recto..... | 99 |
| STEVENS Tijeras finas de disección y tenotomía..... | 92 |
| STIEGLITZ (WILLIAMS) Pinza para espinas..... | 151 |
| STILLE Cinceles..... | 610 |
| STILLE Cizallas para escayolas..... | 677-678 |
| STILLE Gubias..... | 610 |
| STILLE Osteótomos..... | 610 |
| STILLE Perforador de mano..... | 651 |
| STILLE Pinza-gubia..... | 635 |
| STILLE-BARRAYA Pinzas para vasos y tumores..... | 148 |
| STILLE-CRAFOORD Pinzas hemostáticas finas..... | 170 |
| STILLE-DOYEN Separadores..... | 247 |
| STILLE-GIERTZ Costótomo..... | 492 |
| STILLE-LEKSELL Pinzas-gubias..... | 635 |
| STILLE-LUER Pinzas-gubias..... | 634, 636 |
| STILLE-MAYO Tijeras de disección..... | 85 |
| STILLE-MAYO Tijeras DURACUT de disección..... | 48 |
| STILLE-MINI Cizalla para escayolas..... | 677 |
| STILLE-RUSKIN Pinza-gubia..... | 636 |
| STILLE-STRANDELL Separadores para vainas tendinosas..... | 225 |
| STOCKMANN Compresor urétral..... | 426 |
| STRANDELL-STILLE Separadores para vainas tendinosas..... | 225 |
| STRATTE TITE GRIP Porta-agujas..... | 347 |
| STRAUSS Compresor uretal..... | 426 |
| STRULLY Tijera para neurocirugía..... | 100 |
| SUBRAMANIAN ATRAUMATIC-GRIP Pinzas-clamps para aorta..... | 537 |
| Sujetadores de mano..... | 644 |
| SULLIVAN (BROPHY) Tijeras finas de disección..... | 93 |
| SUPER Estetoscopio..... | 5 |
| Surtido para enfermeras..... | 18 |
| SWEET-LAHEY Pinza de disección y ligaduras..... | 189 |
| SYSTRUNK Tijera para hender las uñas..... | 81 |

T

| | |
|--|----------|
| TAKAHASHI Pinzas cortantes para laminectomía..... | 714 |
| Taladro para uñas..... | 645 |
| Taladros..... | 652 |
| Tambores de esterilización..... | 743 |
| TARNIER Fórceps..... | 480 |
| Tarros..... | 737, 747 |
| Tarros para prótesis dental..... | 751 |
| TAYLOR Martillos de percusión..... | 2 |
| TAYLOR Valvas laterales para separadores..... | 287 |
| TAYLOR-CUSHING Pinza de disección TITE GRIP..... | 114 |
| TAYLOR-CUSHING Pinza fina de disección..... | 131 |
| TAYLOR-CUSHING Pinza fina quirúrgica..... | 143 |
| TAYLOR-CUSHING Pinzas auriculares y nasales..... | 136 |
| TAYLOR-SCHMIEDEN Tijera para dura-madre..... | 100 |
| TEALE Pinza para coger el cuello útero..... | 456 |
| Tenotomos..... | 37 |
| Tensor tierra-hilo..... | 660 |
| Tensor de alambres..... | 658 |
| THOMAS-PRICE Pinzas-clamps bronquiales..... | 566 |
| THOMS-ALLIS Pinza intestinal y para tejidos..... | 385 |

| | |
|--|---------------|
| THOMS-GAYLOR Pinza saca-bocados para biopsia..... | 460 |
| THOREK Tijeras de disección..... | 98 |
| THOREK-METZENBAUM Tijeras DURACUT adnex..... | 54 |
| THORLAKSON ATRAUMATIC-GRIP Pinzas-clamps oclusiva inferior..... | 399 |
| THORLAKSON ATRAUMATIC-GRIP Pinzas-clamps oclusiva superior..... | 398 |
| THORLAKSON Separadores..... | 230 |
| THORLAKSON Separadores para pelvis..... | 256-257 |
| Tijeras abdominales..... | 106 |
| Tijeras cuticulares..... | 16 |
| Tijeras de disección..... | 81-93, 95, 98 |
| Tijeras DURACUT..... | 54, 59 |
| Tijeras DURACUT adnex..... | 54 |
| Tijeras DURACUT de disección..... | 47-53 |
| Tijeras DURACUT modelos standard..... | 46 |
| Tijeras DURACUT nasales..... | 58 |
| Tijeras DURACUT para cirugía..... | 46 |
| Tijeras DURACUT para el tabique nasal..... | 59 |
| Tijeras DURACUT para encías..... | 55 |
| Tijeras DURACUT para ginecología..... | 60 |
| Tijeras DURACUT para iridectomía..... | 45 |
| Tijeras DURACUT para la cirugía del recto..... | 59 |
| Tijeras DURACUT para la cirugía plástica..... | 45 |
| Tijeras DURACUT para perineo..... | 60 |
| Tijeras DURACUT para vasos y fistulas..... | 45 |
| Tijeras DURACUT parametrium..... | 60 |
| Tijeras DURACUT uterinas..... | 60 |
| Tijeras DURACUT vasculares..... | 56-57 |
| Tijeras enterótomos..... | 109 |
| Tijeras enterótomos para anatomía..... | 109 |
| Tijeras finas de disección..... | 93 |
| Tijeras finas de disección y tenotomía..... | 92 |
| Tijeras finas DURACUT..... | 45 |
| Tijeras finas para cirugía..... | 68-70 |
| Tijeras nasales..... | 101-102 |
| Tijeras para ala nasal..... | 81 |
| Tijeras para amígdalas..... | 103 |
| Tijeras para arteria coronar..... | 95 |
| Tijeras para arteriotomía..... | 95 |
| Tijeras para cartílago..... | 82 |
| Tijeras para cirugía..... | 71-83 |
| Tijeras para decapitación..... | 109 |
| Tijeras para dura-madre..... | 100 |
| Tijeras para el tabique nasal..... | 102 |
| Tijeras para encías..... | 94 |
| Tijeras para episiotomía..... | 107 |
| Tijeras para hender las uñas..... | 81 |
| Tijeras para incisión..... | 80 |
| Tijeras para la cirugía plástica..... | 70,82 |
| Tijeras para la vena cava..... | 99 |
| Tijeras para ligaduras..... | 352-353 |
| Tijeras para ligaduras DURACUT..... | 353 |
| Tijeras para lobectomía y recto..... | 99 |
| Tijeras para nervio trigémio..... | 100 |
| Tijeras para nervios..... | 93 |
| Tijeras para neurocirugía..... | 100 |
| Tijeras para operaciones..... | 80 |
| Tijeras para perineo..... | 107 |
| Tijeras para tela..... | 674-675 |
| Tijeras para uñas..... | 16 |
| Tijeras para vasos y fistulas..... | 80 |
| Tijeras para vendajes..... | 672-674 |
| Tijeras para vendajes DURACUT..... | 673 |
| Tijeras para vendajes y tela..... | 674 |
| Tijeras umbilicales..... | 108 |
| Tijeras uterinas..... | 104-106 |
| Tijeras vasculares..... | 95-98 |
| Tijeras-micro..... | 62-67 |
| Tijeras-micro de disección..... | 65 |
| Tirabuzones para mioma..... | 458 |
| TISCHLER Pinzas saca-bocados para biopsia..... | 465 |
| TISCHLER-BABY Pinza saca-bocados para biopsia..... | 464 |
| TISCHLER-MORGAN Pinza saca-bocados para biopsia..... | 464 |
| TITAN-LINE Clamps Bulldog..... | 160-161 |
| TITAN-LINE Pinzas hemostáticas finas..... | 166, 168 |
| TITAN-LINE Porta-agujas PERFECT-GRIP..... | 365 |
| TITE GRIP Escofinas..... | 596-597 |
| TITE GRIP Micro-pinzas..... | 118 |
| TITE GRIP Micro-Porta-agujas..... | 338-339 |
| TITE GRIP Pinza de ligadura..... | 113 |

| | |
|---|----------|
| TITE GRIP Pinzas | 118 |
| TITE GRIP Pinzas cierra-hilos | 662 |
| TITE GRIP Pinzas de disección | 113-115 |
| TITE GRIP Pinzas intestinales y para tejidos | 388 |
| TITE GRIP Pinzas para espinas | 151 |
| TITE GRIP Pinzas para extraer alambres | 663 |
| TITE GRIP Pinzas para tejidos y tirar uñas | 116 |
| TITE GRIP Pinzas quirúrgicas | 117-118 |
| TITE GRIP Porta-agujas | 340-350 |
| TITE GRIP Porta-agujas para zurdos | 341 |
| TOENNIS Cuchillo para dura-madre | 37 |
| TOENNIS Disecadores para dura-madre | 700 |
| TOENNIS Porta-agujas | 371 |
| TOENNIS Tijera para la cirugía y disección | 83 |
| TOENNIS TITE GRIP Porta-agujas | 350 |
| TOENNIS-ADSON Tijeras de disección | 89 |
| TOENNIS-ADSON Tijeras DURACUT de disección | 49 |
| TOENNIS-OLIVECRONA (SCOVILLE) Pinza para colocar grapas | 690 |
| TOHOKU Pinzas de campo | 202 |
| Torniquetes | 518, 570 |
| TOWNSEND Pinzas saca-bocados para biopsia | 465 |
| Tractor | 479 |
| Transformador | 472 |
| Transformador eléctrico pequeño para 220 voltios | 11 |
| Traqueotomía, juego | 729-730 |
| TRELAT Espéculos vaginales | 431 |
| TRELAT Periostótomo | 582 |
| Trépanos | 669 |
| Trépanos cutáneos | 20 |
| Trocares | 318-320 |
| Trocares para hidrocele y punción abdominal | 318 |
| Trocares para punción torácica | 318 |
| Trocares para vesícula biliar | 318 |
| Trocares traqueales | 728 |
| TROELTSCH (WILDE) Pinzas auriculares y nasales | 137 |
| TROEMNER Martillos de percusión | 3 |
| TROUSSEAU Dilatador para la tráquea | 728 |
| TROUTMAN Pinza para sujetar y romper hojas de afeitar | 36 |
| TROUTMAN-BARRAQUER Micro-Porta-agujas | 360 |
| TUBBS Dilatador de aorta | 511 |
| Tubos de plástico | 473 |
| Tubos nasales para aspiración | 324 |
| Tubos para aspiración | 324-327 |
| Tubos para aspiración intracardiaco | 327 |
| Tubos para aspiración vascular | 327 |
| Tubos para tunelar | 517 |
| Tubos-compresión | 570 |
| TUFFIER Espátula abdominal e intestinal | 267 |
| TUFFIER Separador costal | 506 |
| TUOHY Agujas para punción lumbar | 328 |
| TUTTLE (SINGLEY) Pinzas agarre del pulmón | 149 |
| TYRELL (GRAEFE) Ganchos para iris | 216 |
| TYRELL (GRAEFE) Ganchos para piel | 216 |

U

| | |
|--|-----|
| UCKERMANN Porta-algodones | 317 |
| UECKERMANN-DENKER Trocares traqueales | 728 |
| UFFENORDE Cucharillas cortantes | 601 |
| ULRICH Cuchillo para fístulas | 37 |
| ULRICH Pinza para huesos | 627 |
| ULRICH Pinzas para vendajes y torundas | 206 |
| UNIVERSAL Cizalla corta-alambres | 665 |
| UNIVERSAL DURACUT Cizalla corta-alambres | 665 |
| UNIVERSAL Trocares | 318 |
| UNNA Saca-comedones | 19 |
| UNNA-VIDAL Saca-comedones | 19 |
| USA MOD. Cucharillas cortantes | 601 |
| USA MOD. Pinzas de disección | 133 |
| USA MOD. Separador para escayolas | 682 |
| USA MOD. Tijera umbilical | 108 |
| US-ARMY (PARKER-LANGENBECK) Separadores | 231 |

V

| | |
|-----------------------|-----|
| VALLEIX Histerómetros | 446 |
| Valvas | 293 |

| | |
|---|---------------|
| Valvas laterales | 287, 289 |
| Valvas para separadores | 308 |
| Valvas para separadores abdominales KIRSCHNER | 307 |
| Valvas vaginales | 434-437, 439 |
| VAN BUREN Bujías dilatadoras | 424 |
| VAN BUREN Pinza para secuestro | 623 |
| VAN DOREN Pinza saca-bocados para biopsia | 461 |
| VANNAS Micro-tijeras | 62-63, 65 |
| VANNAS MOD. TÜBINGEN Micro-tijeras | 62 |
| VANNAS-YASARGIL Micro-tijeras | 66 |
| VARCO Pinzas hemostática finas | 170 |
| VASCULAR PERFECT-GRIP Porta-agujas | 364 |
| VASCULAR PERFECT-GRIP TITAN-LINE Porta-agujas | 365 |
| VASCULAR-RYDER TITE GRIP Micro-Porta-agujas | 340 |
| Vasos graduados | 751 |
| Venda-compresión | 570 |
| VERBRUGGE Pinzas para huesos | 628 |
| VERBRUGGE-MÜLLER Elevadores para huesos | 579 |
| VERESS Agujas para el neumoperitoneo | 329 |
| VERNET-GIL (MARBERGER) Separadores para venas y hilares | 223 |
| VICKERS Dispensador de agujas | 657 |
| VICKERS Separador de mano y túnel de carpo | 271 |
| VICKERS Separador para dedos | 271 |
| VICKERS Separador profundo para mano y antebrazo | 271 |
| VICKERS Sujetador de mano | 644 |
| VIDAL Legra para lupus | 19 |
| VIDAL-UNNA Saca-comedones | 19 |
| VIRCHOW Cuchillos para cerebro | 40 |
| VIRTUS (RALKS) Pinza para espinas | 151 |
| WISE Micro-pinzas de ligadura | 122 |
| VOGEL Cánula para punción del seno maxilar | 319 |
| VOLKMANN Cucharillas cortantes | 600, 602, 606 |
| VOLKMANN Separadores | 233-234 |
| VOLKMANN Separadores y separadores para huesos | 232 |
| VON PETZ Aparato para sutura estomacal e intestinal | 404 |

W

| | |
|--|----------|
| WAGENER Ganchitos auriculares | 213 |
| WAGNER Elevador para huesos | 577 |
| WAGNER Martillo | 620 |
| WAGNER Periostótomos | 591 |
| WALB Cuchillo post mortem | 40 |
| WALDMANN Tijera para perineo (episiotomía) | 107 |
| WALTON-LISTON (BÖHLER) Pinzas cortantes para huesos | 638 |
| WANGENSTEEN Pinza de disección TITE GRIP | 115 |
| WANGENSTEEN Porta-agujas | 369 |
| WANGENSTEEN TITE GRIP Porta-agujas | 347 |
| WARTENBERG Algesímetro | 4 |
| WATSON-CHEYNE Disecador | 574 |
| WATSON-WILLIAMS Escofina | 593 |
| WAUGH Pinza fina de disección | 131 |
| WAUGH Pinza fina quirúrgica | 143 |
| WEBER ATRAUMATIC-GRIP Pinzas-clamps para anastomosis de aorta | 548 |
| WEBER Estesiometro | 4 |
| WEBSTER Porta-agujas | 363 |
| WEBSTER TITE GRIP Porta-agujas | 342 |
| WEIL-BLAKESLEY Pinzas cortantes para laminectomía | 714 |
| WEISSBARTH Espéculo vaginal | 442 |
| WEITLANER Separadores con retenida automática | 272-274 |
| WELLS-SPENCER Pinzas hemostáticas | 173 |
| WERTHEIM (BOZEMANN) TITE GRIP Porta-agujas | 346 |
| WERTHEIM Pinzas-clamps para histerectomía | 194-195 |
| WERTHEIM Tijeras uterinas | 105 |
| WERTHEIM-CULLEN Pinza-clamp para pedúnculo renal | 191 |
| WERTHEIM-DE BAKEY (ROGERS) ATRAUMATIC-GRIP Pinzas-clamps parametrium | 197 |
| WEST Cinceles | 607 |
| WEST Gubias | 607 |
| WIENER Escofinas | 593 |
| WIENER MOD. Porta-ligadura | 378 |
| WILLIAMS Pinza intestinal y para tejidos | 388 |
| WILDE (TROELTSCH) Pinzas auriculares y nasales | 137 |
| WILLETT Pinza para pericráneo | 481 |
| WILLIAMS (STIEGLITZ) Pinza para espinas | 151 |
| WILLIAMS-WATSON Escofina | 593 |
| WILLIGER Cucharillas cortantes | 598, 600 |
| WILLIGER Elevadores | 574 |

| | |
|--|----------|
| WILLIGER Martillo | 617 |
| WILLIGER Periostótomos | 582 |
| WINTER Estetoscopio | 5 |
| WINTER Pinzas para aborto y placenta | 482 |
| WITTNER Pinza saca-bocados para biopsia | 462 |
| WOLFF Pinza para romper escayolas | 682 |
| WOLFSON-DE MARTEL Clamps para anastomosis del colón | 402 |
| WOLFSON-DE MARTEL Pinza para cerrar clamps | 402 |
| WOLFSON-DE MARTEL Porta-clamp | 402 |
| WOOD-CRILE Porta-agujas | 366, 368 |
| WOOD-CRILE TITE GRIP Porta-agujas | 343 |
| WOOD-CRILE TITE GRIP Porta-agujas para zurdos | 341 |
| WRIGLEY Fórceps | 480 |
| WULLSTEIN Aspirador micro | 321 |
| WULLSTEIN Cánula para aspiración | 322 |
| WULLSTEIN Separadores con retenida automática | 275 |
| WYLLIE ATRAUMATIC-GRIP Pinzas-clamps para anastomosis de aorta | 549 |

Y

| | |
|--|----------|
| YANKAUER Tubos para aspiración | 325-326 |
| YASARGIL Cucharilla cortante | 695 |
| YASARGIL Cuchillo para vasos | 695 |
| YASARGIL Disecador | 694 |
| YASARGIL Ganchos con muelle para la fijación de la galea | 691 |
| YASARGIL Guía-ligadura | 697 |
| YASARGIL Legras | 694-695 |
| YASARGIL Micro-pinzas | 125 |
| YASARGIL Micro-tijeras de disección | 67 |
| YASARGIL Mirco-tijeras | 66 |
| YASARGIL PERFECT-GRIP Micro-Porta-agujas | 362 |
| YASARGIL Pinza para hipófisis | 719 |
| YASARGIL Pinzas de agarre para tejido y tumor | 126 |
| YASARGIL Tubos para aspiración | 324 |
| YASARGIL-MINI Clips vasculares | 154 |
| YASARGIL-MINI Pinzas para aplicar clips vasculares | 154 |
| YASARGIL-SAMII Pinza de agarre para tejido y tumor | 126 |
| YASARGIL-STANDARD Clips vasculares | 154 |
| YASARGIL-STANDARD Pinzas para aplicar clips vasculares | 154 |
| YASARGIL-VANNAS Micro-tijeras | 66 |
| YEOMAN Pinzas saca-bocado para biopsia rectal | 412 |
| YOUNG Gancho para el bulbus | 422 |
| YOUNG Pinza tira-lengua | 23 |
| YOUNG Separadores para la prostata | 422 |
| YOUNGE-KEVOURKIAN Curetas para biopsia endo-cerviz | 459 |
| YOUNGE-KEVOURKIAN Pinzas saca-bocados para biopsia | 463, 465 |
| YOUNG-HRYNTSCHAK Porta-agujas de bumerang | 372 |
| YOUNG-MILLIN Porta-agujas de bumerang | 372 |

Z

| | |
|--|-----|
| ZAUFAL-JANSEN Pinza-gubia | 633 |
| ZENKER Pinzas de disección y ligaduras | 188 |
| ZENKER Separadores para cirugía profunda | 259 |
| ZIEGLER Cinta | 10 |
| ZIEGLER Espejo frontal | 10 |
| ZIELKE Gubias | 614 |
| ZOELLNER Aspirador micro | 321 |
| ZWEIFEL TITE GRIP Porta-agujas | 349 |

A

- Abaisse-langue en bois 12
 Abaisse-langues 12
 Abdominaux et intestinaux, Spatules 266-267
 Abdominaux, Ecarterus 297-309
ABRAMS Aiguille à ponction pleurale 518
ABRAMS Aiguille pour la ponction de la plèvre 329
 Accessoires pour écarteurs autofixants de **LEYLA** 703, 705
 Accessoires pour écarteurs **LEYLA** 705
ADAIR-ALLIS Pince à préhension de l'intestin 384
ADAIR Pince pour abaissement du col de l'utérus 452
ADAMS-MAYO Ecarteurs pour appendicectomie 284
ADLERKREUTZ Pincers vaisseaux et tumeurs 148
 Adnex, Ciseaux **DURACUT** 54
ADSON-ANDERSON Ecarteur autostatique 276
ADSON-ANDERSON Ecarteur pour laminectomie 276
ADSON-BABY Pincers à disséquer et à ligatures 180
ADSON-BECKMANN Ecarteurs autostatiques 279
ADSON-BROWN Pincers fines chirurgicales 141
ADSON-BROWN TITE GRIP Pincers à dissection à griffes 117
ADSON-MICRO Pincers fines à dissection 129
ADSON-MICRO Pincers fines chirurgicales 140-141
ADSON-MICRO TITE GRIP Pincers à dissection à griffes 117
ADSON-TOENNIS Ciseaux à dissection 89
ADSON-TOENNIS Ciseaux à dissection **DURACUT** 49
ADSON Canules d'aspiration 323
ADSON Crochets à nerfs et à vaisseaux 215
ADSON Ecarteur pour laminectomie 280
ADSON Ecarteurs autostatiques 273, 276, 278
ADSON Ecarteurs pour hemilaminectomie 277
ADSON Mèche hélicoidales 652
ADSON Pince-guide et pour protéger la dure-mère 650
ADSON Pincers fines à dissection 129
ADSON Pincers fines chirurgicales 140-141
ADSON Pincers hémostatiques fines 169
ADSON Porte-aiguilles 367
ADSON Rucine-raspatoire 586
ADSON TITE GRIP Pincers à dissection 113
ADSON TITE GRIP Pincers à dissection à griffes 117
 Aesthésiomètre 4
 Agrafes 379, 404
 Agrafes en argent 690
 Agrafes hémostatiques pour cuir chevelu 691
 Agrafes, Fil d'argent pour fabriquer des agrafes 690
 Agrafes, Pincers à poser 379
 Aiguille à hypodermique 486
 Aiguille à ponction pleurale 518
 Aiguille pour la ponction aveugle du foie 329
 Aiguille pour la ponction contrôlée du foie 329
 Aiguille pour la ponction du la plèvre 329
 Aiguille trompette guide 486
 Aiguilles à biopsie 518
 Aiguilles à ligatures 374-376
 Aiguilles à ponction sternale 518
 Aiguilles à suture, Support pour stériliser 736
 Aiguilles à sutures 354-356
 Aiguilles de **REVERDIN** 373
 Aiguilles et tissus, TITE GRIP Pincers pour saisir et tirer 116
 Aiguilles guides 334
 Aiguilles intestinales 354
 Aiguilles passe-fils 660
 Aiguilles pour amygdales 328
 Aiguilles pour la cloison nasale 328
 Aiguilles pour la pneumopéritone 329
 Aiguilles pour ophtalmologie 354
 Aiguilles pour ponction lombaire 328
 Aiguilles spéciales 328
 Aiguilles vasculaires 354
 Aiguilles vasculaires pour irrigation 322
 Ailes du nez, Ciseaux 81
ALAN-PARK Ecarteur rectal 408
ALDERDYCE Dissecteur 574
ALDINGER-HOHMANN Levier à os 580
 Alésiors pour étrier traction crânienne de **CRUTCHFIELD** 689
ALEXANDER-FARABEUF Rugines à costales 497
ALEXANDER Ciseaux-burins 609
ALEXANDER Gouges 609
ALEXANDER Ostéotomes 609
ALEXANDER Pince emporte-pièces à biopsie 463
 Algésimètres 4
ALLEN Pincers-clamps intestinales 390
ALLIS-ADAIR Pince à préhension de l'intestin 384
ALLIS-BABY Pince à préhension de l'intestin 383
ALLIS-BOYS Pince à préhension de l'intestin 384
ALLIS-JUDD Pincers à préhension de l'intestin 384
ALLIS-OCBSNER Pince à préhension de l'intestin 383
ALLIS-THOMS Pince à préhension de l'intestin 385
ALLIS ATRAUMATIC-GRIP Pincers à préhension de l'intestin 389
ALLIS Pincers à préhension de l'intestin 383-385
ALLISON Spatule pulmonaire 260
ALM Ecarteurs autostatiques 270
ALY Algésimètre 4
AMANN Conducteur porte-tampon 447
 Amnioscopes 472
 Amnioscopie, Instrumentation 472-473
 Amniotome 477
 Amputation 570
 Amputation et résection, Scies 572, 573
 Amygdales et hémostatiques, Pincers 179
 Amygdales, Aiguilles 328
 Amygdales, ciseaux 103
 Anastomose de l'aorte, Pincers-clamps avec denture **DE BAKEY** 548, 549
 Anastomose du rectum, Pincers-clamps 400
 Anastomose du rectum, Pincers-clamps ATRAUMATIC-GRIP 401
 Anastomose et intestinales, Pincers-clamps 402
 Anastomose, Clamps 402
 Anastomose, Pincers-clamps 520-523
 Anastomose, Pincers-clamps (veine cave) 565
 Anastomose, Pincers-clamps avec denture **COOLEY** 559-560
 Anastomose, Pincers-clamps avec denture **DE BAKEY** 542-544
 Anatomie, Ciseaux-entérotomes 109
ANDERSON-ADSON Ecarteur autostatique 276
ANDERSON-ADSON Ecarteur pour laminectomie 276
ANDREW-PYNCHON Canule d'aspiration 325
 Anévrisme de l'aorte, Pince-clamp 561
 Anévrisme de l'aorte, Pincers-clamps avec denture **DE BAKEY** 545-547
 Anus et rectum, Dilatateurs 407-408
 Anuscopes 407
 Aorte, Pince-clamp 561
 Aorte, Pince-clamp pour anévrisme 561
 Aorte, Pincers-clamps 537
 Aorte, Pincers-clamps avec denture **DE BAKEY** 538-540
 Aortiques, Dilatateurs 511
 Appareil à suture 404
 Appareil compressif 570
 Appareil et crayons pour marquer et écrire sur métal, verre, plastique etc. 757
 Appareils pâtés, Couteaux 679
 Appareils plâtrés et étoffes d'habillement, Cisailles 675
 Appareils plâtrés, Cisailles 676-678
 Appareils plâtrés, Scie 679
 Appendicectomie, Ecarteurs 284
 Appendicectomie, Ecraseur et clamp 403
 Applicateurs pour clips vasculaires 154-155
 Approximateurs 157-159
 Approximateurs, Pincers 158
ARMY-US (PARKER-LANGENBECK) Ecarteurs 231
ARMYTAGE-GREEN Pince-clamp utérine pour hémostase 481
 Artériotomie, Ciseaux 95
ARTHUR Pince à échardes 151
 Articles pour infirmières 751
 Articulation sphérique pour fixation du bras 705
 Aspirateurs ligateurs pour hémorroïdes 411
 Aspiration et biopsie, Curettes 471
 Aspiration, Canules 320-327
 Aspiration, Curettes 471
 ATRAUMATIC-GRIP Clamps Bulldog avec denture **DE BAKEY** 525-528
 ATRAUMATIC-GRIP Clamps patent-ductus avec denture **DE BAKEY** 531
 ATRAUMATIC-GRIP Pince à préhension de l'intestin 389
 ATRAUMATIC-GRIP Pincers-clamps à anastomose
 avec denture **COOLEY** 559-560
 ATRAUMATIC-GRIP Pincers-clamps à anastomose avec
 denture **DE BAKEY** 542-544
 ATRAUMATIC-GRIP Pincers-clamps à anastomose du rectum 401
 ATRAUMATIC-GRIP Pincers-clamps à bronches avec
 denture **DE BAKEY** 552
 ATRAUMATIC-GRIP Pincers-clamps à occlusion 398-399

| | |
|---|-------------------|
| ATRAUMATIC-GRIP Pincés-clamps intestinales | 391-393, 395-396 |
| ATRAUMATIC-GRIP Pincés-clamps pour anastomose de l'aorte avec denture DE BAKEY | 548-549 |
| ATRAUMATIC-GRIP Pincés-clamps pour anévrisme de l'aorte avec denture DE BAKEY | 545-547 |
| ATRAUMATIC-GRIP Pincés-clamps pour aorte avec denture DE BAKEY | 538-540 |
| ATRAUMATIC-GRIP Pincés-clamps pour coarctation avec denture COOLEY | 557 |
| ATRAUMATIC-GRIP Pincés-clamps pour coarctation avec denture DE BAKEY | 532-533 |
| ATRAUMATIC-GRIP Pincés-clamps pour la carotide avec denture LAWTON | 524 |
| ATRAUMATIC-GRIP Pincés-clamps pour veine cave avec denture DE BAKEY | 550 |
| ATRAUMATIC-GRIP Pincés-clamps stomacales | 397 |
| ATRAUMATIC-GRIP Pincés-clamps universelles avec denture DARDIK | 554 |
| ATRAUMATIC-GRIP Pincés-clamps universelles avec denture DE BAKEY | 553 |
| ATRAUMATIC-GRIP Pincés-clamps vasculaires périphériques avec denture DE BAKEY | 535-536 |
| ATRAUMATIC-GRIP Pincés à disséquer et à ligatures avec denture DE BAKEY | 551 |
| ATRAUMATIC-GRIP Pincés vasculaires | 135 |
| ATRAUMATIC-GRIP Pincés vasculaires | 520 |
| ATRAUMATIC-GRIP Pincés vasculaires avec denture COOLEY | 555-562 |
| ATRAUMATIC-GRIP Pincés vasculaires avec denture DE BAKEY | 529-530, 537, 554 |
| ATRAUMATIC-GRIP Pincés vasculaires avec denture LAWTON | 521-523 |
| ATRAUMATIC-GRIP Pincés vasculaires pour occlusion tangentielle | 541 |
| Atrium, Ecarteurs | 509 |
| AUFRICHT Ciseaux pour chirurgie plastique | 82 |
| AUFRICHT Râpes | 593 |
| Aiguilles à biopsie | 329 |
| Auriculaires et nasales, Pincés | 136-137 |
| Auriculaires, Pincés-clamps | 564 |
| Auriculaires, Sondes | 322 |
| AUSTIN Micro-pincés à ligatures | 122 |
| AUVARD-BERLIND Spéculum vaginal | 441 |
| AUVARD Spéculums vaginaux | 441 |
| Avortement et placenta, Curettes | 484 |

B

| | |
|---|--------------|
| BABCOCK ATRAUMATIC-GRIP Pincés à préhension de l'intestin | 389 |
| BABCOCK Pincés à préhension de l'intestin | 385, 388-398 |
| BABY-ADSON Pincés à disséquer et à ligatures | 180 |
| BABY-ALLIS Pince à préhension de l'intestin | 383 |
| BABY-BAILEY Rapprocheur de côtes | 508 |
| BABY-BALFOUR Ecarteur abdominal | 300 |
| BABY-COLLIN Ecarteur abdominal | 297 |
| BABY-CRILE Pincés hémostatiques fines | 166 |
| BABY-DOYEN ATRAUMATIC-GRIP Pincés-clamps intestinales | 391 |
| BABY-FINOCHIETTO-HAIGHT Ecarteur à côtes en ALUMINIUM | 501 |
| BABY-FINOCHIETTO Ecarteur à côtes | 503 |
| BABY-GILLIES Porte-aiguilles avec ciseaux | 370 |
| BABY-GILLIES TITE-GRIP Porte-aiguilles | 348 |
| BABY-GOSSET Ecarteur abdominal | 299 |
| BABY-KELLY Pincés hémostatiques fines | 168 |
| BABY-KOCHER ATRAUMATIC-GRIP Pincés-clamps intestinales | 391 |
| BABY-LEXER Ciseaux à dissection | 87 |
| BABY-MEEKER Pincés à disséquer et à ligatures | 180 |
| BABY-METZENBAUM Ciseaux à dissection | 89 |
| BABY-MIKULICZ Pincés-clamps pour péritoine | 192 |
| BABY-MIXTER Pincés à disséquer et à ligatures | 180 |
| BABY-MOSQUITO (HARTMANN) Pincés hémostatiques fines | 164 |
| BABY-OLSEN-HEGAR TITE-GRIP Porte-aiguilles | 348 |
| BABY-OVERHOLT Pincés à disséquer et à ligatures | 183 |
| BABY-PAYR Pince-clamp et écreuseur pour l'intestin et l'estomac | 403 |
| BABY-ROUX Ecarteur double | 228 |
| BABY-SATINSKI Pincés-clamps à anastomose (veine cave) | 565 |
| BABY-TISCHLER Pince emporte-pièces à biopsie | 464 |
| BACKHAUS Pincés à compresses | 201 |
| BADGLEY Ecarteur pour laminectomie | 286 |
| BAHNSON-DE BAKEY ATRAUMATIC-GRIP Pincés-clamps pour anévrisme de l'aorte | 545 |
| BAILEY-BABY Rapprocheur de côtes | 508 |
| BAILEY-GIBBON Rapprocheur de côtes | 508 |

| | |
|--|---------|
| BAILEY ATRAUMATIC-GRIP Pincés-clamp pour aorte avec denture DE BAKEY | 538 |
| BAILEY Rapprocheur de côtes | 508 |
| Bâillon | 22 |
| BAINBRIDGE-DE BAKEY ATRAUMATIC-GRIP Pincés vasculaires | 530 |
| BAINBRIDGE Pincés-clamps intestinales | 390 |
| BAKES Jeux de dilateurs biliaires | 416 |
| BALFOUR-BABY Ecarteur abdominal | 300 |
| BALFOUR-KIRSCHNER Valves pour écarteurs abdominaux | 307 |
| BALFOUR Ecarteurs abdominaux | 300-303 |
| BALFOUR modif. Ecarteurs abdominaux | 302 |
| BALLENGER-FOERSTER Pincés à tampons et éponges | 209 |
| BALLENTINE-HEANEY Pince à hystérectomie | 196 |
| BALLENTINE Pincés à hystérectomie | 196 |
| Bande compressive | 570 |
| Bandeau frontal en celluloid blanc | 10 |
| Bandeau frontal plastique noir | 10 |
| Bandeaux frontaux | 10 |
| BARNES Canule d'aspiration | 321 |
| BARR Dilatateur pour anus et rectum | 408 |
| BARRAQUER-TROUTMAN Micro-Porte-aiguilles | 360 |
| BARRAQUER Micro-Porte-aiguilles | 360 |
| BARRAQUER Pince à épiler | 152 |
| BARRAYA-STILLE Pincés vaisseaux et tumeurs | 148 |
| BARRETT Pince pour abaissement du col de l'utérus | 452 |
| BARTH Curette | 599 |
| Bases de fixation | 703 |
| Bassins | 748 |
| Bassins de lit | 750 |
| Bassins réniformes | 750 |
| Bassins triangulaires | 750 |
| BAUMGARTNER-HEGAR TITE GRIP Porte-aiguilles | 342 |
| BAUMGARTNER Porte-aiguilles | 366 |
| BAUMGARTNER TITE GRIP Porte-aiguilles | 342 |
| BEACHAM Amniotome | 477 |
| BECK-COOLEY ATRAUMATIC-GRIP Pincés-clamps à anastomose | 560 |
| BECK-DE BAKEY ATRAUMATIC-GRIP Pincés-clamps à anastomose | 543 |
| BECK-DE BAKEY ATRAUMATIC-GRIP Pincés-clamps pour veine cave | 550 |
| BECK-DE BAKEY Pince-clamp pour aorte | 537 |
| BECKMANN-ADSON Ecarteurs autostatiques | 279 |
| BECKMANN-EATON Ecarteur pour laminectomie | 280 |
| BECKMANN Ecarteur pour laminectomie | 280 |
| BEEBEE Pincés coupe-fils | 665 |
| BEER Pince à épiler | 152 |
| BELMONT-RUMEL Tourniquets | 518 |
| BENGOLEA Pincés hémostatiques fines | 172 |
| BENNETT Leviers à os | 581 |
| BENSON Ecarteur du pylore | 403 |
| BERGER Loupes binoculaires frontales | 8 |
| BERGER Pince emporte-pièces à biopsie | 462 |
| BERGMANN Cisailles pour étoffes d'habillement et appareils plâtrés | 675 |
| BERGMANN Maillets | 621 |
| BERLIND-AUVARD Spéculum vaginal | 441 |
| BERLINER Marteaux à réflexes | 2 |
| BERNHARD Pincés à compresses | 201 |
| BETHUNE Costotome | 493 |
| BEYER Pince emporte-pièces à laminectomie | 707 |
| BEYER Pincés-gouges | 632-633 |
| BIEMER-MÜLLER Approximateurs | 157 |
| BIEMER Micro-ciseaux pour veines | 63 |
| BIEMER Serre-Fines | 156 |
| BIER Scie à amputation et résection | 573 |
| Biliaires, Dilatateurs | 416 |
| Biliaires, Dilatateurs à voies | 415 |
| BILL Forceps | 479 |
| Billes, Manche | 721 |
| Biopsie endo-cervicale, Curettes | 460 |
| Biopsie et aspiration, Curettes | 471 |
| Biopsie osseuse, Instruments | 669 |
| Biopsie rectale, Pincés | 412 |
| Biopsie vertébral, Set CRAIG-KOLGER | 720-721 |
| Biopsie, Aiguilles | 329 |
| Biopsie, Aiguilles | 518 |
| Biopsie, Curettes | 459-460 |
| Biopsie, Pince emporte-pièces | 460-465 |
| BIRCHER-GANSKE Pincés à ménisque et cartilage | 640 |
| BIRCHER Bistouris à ménisque | 643 |
| Bistouris | 37, 40 |
| Bistouris à autopsie | 40 |

- Bistouris à ménisque. 642-643
 Bistouris pour plastie du nez 37
BLAKE-MAYO Pincés pour calculs biliaires 418
BLAKE Curette utérine 466
BLAKE Pincés pour calculs biliaires 418
BLAKESLEY-WEIL Pincés emporte-pièces à laminectomie 714
BLESSING Ciseaux pour chirurgie rectale DURACUT 59
BLOUNT Ecarteurs pour genou 641
BLOUNT Elévateur pour la hanche 580
BLUMENTAHL Pincés-gouges 631
BLUNT Epingle à instruments 736
BOETTCHER Ciseaux pour les amygdales 103
BÖHLER (LISTON-WALTON) Pincés coupantes 638
BÖHLER Etriers à extension 654
BÖHLER Pincés-gouges 633
 Boîte ronde pour instruments de micro-chirurgie 737
 Boîtes pour instruments 746
 Boîtes pour stérilisation 739-741
 Boîtes pour stérilisation en plastique 742
 Boîtes pour stérilisation et coservation 738
 Boîtes pour stériliser des aiguilles de suture 357
 Boîtes rondes pour stérilisation 743
BONN (MOD.) Pincés fines chirurgicales 138
BONNEY Pincés à dissection 134
BONNEY Pincés chirurgicales 147
BONNEY TITE GRIP Pince 118
BONNEY TITE GRIP Pince à dissection 115
 Boomerangs, Porte-aiguilles 372
BOSE Ecarteurs pour trachéotomie 728
 Bougies dialatatrices 424
BOYS-ALLIS Pince à préhension de l'intestin 384
BOZEMANN-DOUGLAS Pincés à pansements 208
BOZEMANN (WERTEHIM) TITE GRIP Porte-aiguilles 346
BOZEMANN Pincés à pansements 208
BRAND Conducteurs à tendons 648
 Bras de fixation à l'articulation sphérique 705
 Bras flexible pour fixation aux têtes d'accouplement 703
BRAUN-SIMPSON Forceps 478
BRAUN-STADLER Ciseaux à périnée 107
BRAUN Cranioclaste 485
BRAUN Crochet pour décapitation 485
BRAUN Dépresseur utérin 447
BRAUN Pincés pour abaissement du col de l'utérus 452, 454
BRAWLEY Râpe 593
BREISKY Spécimens vaginaux 438, 440
BRIDGE Pincés à disséquer et à ligatures 187
BRINKERHOFF Spécimens rectaux 406
 Broches-tire, Pincés 663-664
 Broches filiformes, Distributeurs 657
 Broches, Distributeurs 656
BROHPY Pincés fines à dissection 131
 Bronches, Pincés-clamps 566
 Bronches, pincés-clamps ATRAUMATIC-GRIP 552
BROPHY (SULLIVAN) Ciseaux fins à dissection 93
BROPHY Pincés fines chirurgicales 143
 Brosse à nettoyer les canules trachéales 727
 Brosse à ongles 752
 Brosses et essuie-mains, Paniers 753
 Brosses, Distributeurs 752
BROWN-ADSON Pince fine chirurgicale 141
BROWN-ADSON TITE GRIP Pincés à dissection à griffes 117
BROWN Pincés chirurgicales 148
BROWN Porte-aiguilles 366
BROWNE-DENIS Ecarteur abdominal 305
BRUENINGS Abaisse-langue 12
BRUNNER Ecarteurs pour interventions en profondeur 252-253
BRUNNER Pince-clamp à anastomose du rectum 400
BRUNS Cisailles pour appareils plâtrés 676
BRUNS Curettes 602-603
BUCHWALD Abaisse-langue 12
BUCK-GRAMCKO Levier à os 576
BUCK Marteaux à réflexes 3
BUIE-SMITH Dilatateur pour anus et rectum 408
BUIE Pince-clamp à pression 409
 Bulbus, Crochet 422
BULEAU Trocart 318
 Bulldog Clamps 163, 556
 Bulldog, Clamps avec denture **DE BAKEY ATRAUMATIC-GRIP** 525-528
 Bulldog, Clamps TITAN-LINE 160-161
 Bulldog, Micro Clamps 162
BUMM Curettes à avortement et placenta 484
BUMM Curettes utérines 470
BUNNELL Conducteur à tendons 646
BUNNELL Perforateur à mainvèle 653
BUNNELL Strippers à tendons 646
BURFORD-FINOCHIETTO Ecarteurs à côtes 503
BURFORD-FINOCHIETTO Ecarteurs à côtes en ALUMINIUM 502
 Burins-ciseaux 607, 609-610, 613-614
 Burins-ciseaux et gouges avec manche en „Ferrozell“ 614
 Burins-ciseaux spongieuse 615
 Burins-ciseaux, ostéotomes et gouges avec manche en „Ferrozell“ 611-613
BURKE Pince emporte-pièces à biopsie 464
BUSH Ciseaux pour le cordon ombilical 108
 Bypass, Tunnelisateur 517

C

- Cadres de Stérilisation 737
 Calculs biliaires, Curettes 417
 Calculs biliaires, Pincés 418-419
 Calculs rénaux, Pincés 420-421
CALNE ATRAUMATIC-GRIP Pincés-clamps pour veine cave 550
CANAD.MODELL Bistouris à ménisque 643
 Canal lacrymal, Stylets 312
CANNON Couteau pour la tunique interne 513
CANNON Sondes à endartérectomie 514
CANNON Spatule pour la tunique interne 513
 Canule de trocart 721
 Canules d'aspiration 320-327
 Canules d'irrigation 322
 Canules parlantes 726-727
 Canules pour la trachéotomie 725-727
CAPLAN Ciseaux pour septum DURACUT 59
 Capsules, Pince pour saisir 423
CARMALT-ROCHESTER Pincés hémostatiques 178
CAROLL Porte-aiguilles 366
 Carotide, Pincés-clamps 527, 537
 Carotide, Pincés-clamps avec denture **LAWTON ATRAUMATIC-GRIP** 524
CAROTIS-DE BAKEY ATRAUMATIC-GRIP Clamp Bulldog 525
 Carrées-pointes 650
CARROLL Conducteur à tendons 648
CARROLL TITE GRIP Porte-aiguilles 344
 Cartilage et ménisque, Pincés 640
 Cartilage, Ciseaux 82
CASPAR Crochets à nerfs et à vaisseaux 215
CASPAR Ecarteur pour chirurgie lombaire 294-295
CASPAR Ecarteurs 245
CASPAR Ecarteurs pour colonne vertébrale 288, 290-292
CASPAR Pincés emporte-pièces à laminectomie 718-719
CASPAR Rugines-raspatoires 585
CASTANEDA Ecarteurs à côtes en ALUMINIUM 500
CASTANEDA Pincés-clamps pour anastomose 520
CASTANEDA Pincés-clamps universelles 520
CASTROVIEJO-MICRO Micro-Porte-aiguilles 358
CASTROVIEJO Compas 7
CASTROVIEJO Pincés fines chirurgicales 138
CASTROVIEJO Pincettes pour saisir et casser les lames de rasoir 36
CASTROVIEJO Porte-aiguilles 363
CASTROVIEJO TITE GRIP Micro-Porte-aiguilles 338-339
 Catgut, fils 353
 Cathéters et tubes, Pince conductrice 473
CATLIN Couteau à amputation 38
 Cérébrales, Spatules 706
 Cerlage, Fil 660
 Cerlage, Instruments 660
 Césarienne, Levier à tête utilisé 481
 Champs en papier, Pincés 202
CHAMPY Instruments pour biopsie osseuse 669
CHAPUT Pince à préhension de l'intestin 383
CHARRIERE Scies à amputation et résection 572-573
 Chasse-greffons 606
CHEATTLE Pincés à stérilisation 734
CHERON Pincés à pansements et tampons 207
 Chevalets de stérilisation 737
CHEVALIER-JACKSON Canules pour la trachéotomie 726
CHEVALIER Ecarteur à côtes 507
CHEYNE-WATSON Dissecteur 574

| | | | |
|---|-----------------------|---|-------------------|
| CHILDE Pincés à affronter | 378 | Ciseaux vasculaires et pour fistules | 80 |
| Chirurgicales, Pincés | 144-148 | Ciseaux vasculaires et pour fistules DURACUT | 45 |
| Chirurgicales, Pincés fines | 138-143 | Ciseaux, Porte-aiguilles | 370 |
| Chirurgie laser, Instruments | 448-451 | CITELLI Pincés emporte-pièces à laminectomie | 707 |
| Chirurgie lombaire, Ecarteurs | 294-295 | Clamp-pince à pression | 409 |
| Chirurgie plastique, Ciseaux | 70, 82 | Clamp-pince musculaire | 728 |
| Chirurgie plastique, Crochet | 217-218 | Clamp-pince périphérique | 558 |
| Chirurgie, Ciseaux | 71-83 | Clamp-pince pour anévrisme de l'aorte | 561 |
| Chirurgie, Ciseaux modèles fins | 78-79 | Clamp-pince pour aorte | 561 |
| Chirurgie, Ciseaux modèles standard | 72-77 | Clamp-pince pour la carotide | 537 |
| Circoncision, Instruments | 426 | Clamp et écreuseur à appendicectomie | 403 |
| Cisaille et ciseau-burins à sternum | 492 | Clamp patent-ductus droit | 556 |
| Cisailles à pansements et étoffes d'habillement | 674 | Clamps-pincés à anastomose (veine cave) | 565 |
| Cisailles pour appareils plâtrés | 676-678 | Clamps-pincés à anastomose avec denture COOLEY | 559-560 |
| Cisailles pour étoffes d'habillement et appareils plâtrés | 675 | Clamps-pincés à anastomose avec denture DE BAKEY | 542-544 |
| Ciseau-burins et cisaille à sternum | 492 | Clamps-pincés à anastomose du rectum | 400 |
| Ciseaux-burins | 607, 609-610, 613-614 | Clamps-pincés à anastomose du rectum ATRAUMATIC-GRIP | 401 |
| Ciseaux-burins et gouges avec manche en „Ferrozell“ | 614 | Clamps-pincés à bronches | 566 |
| Ciseaux-burins spongieuse | 615 | Clamps-pincés à bronches ATRAUMATIC-GRIP | 552 |
| Ciseaux-burins, ostéotomes et gouges avec manche en „Ferrozell“ | 611-613 | Clamps-pincés à occlusion ATRAUMATIC-GRIP | 398-399 |
| Ciseaux-entérotomes | 109 | Clamps-pincés auriculaires | 564 |
| Ciseaux-entérotomes pour l'anatomie | 109 | Clamps-pincés avec denture DE BAKEY ATRAUMATIC-GRIP | 538-540 |
| Ciseaux-Micro | 62-67 | Clamps-pincés iliaques | 558 |
| Ciseaux-micro pour veines | 63 | Clamps-pincés intestinales | 390-394 |
| Ciseaux (à épisiotomie) et à périnée | 107 | Clamps-pincés intestinales ATRAUMATIC-GRIP | 395 |
| Ciseaux à artériotomie | 95 | Clamps-pincés intestinales et à anastomose | 402 |
| Ciseaux à chirurgie | 71-83 | Clamps-pincés pour anastomose | 520-523 |
| Ciseaux à chirurgie DURACUT | 46 | Clamps-Pincés pour anastomose de l'aorte ATRAUMATIC-GRIP | 548-549 |
| Ciseaux à chirurgie et à dissection | 81-83 | Clamps-pincés pour anévrisme de l'aorte ATRAUMATIC-GRIP | 545-547 |
| Ciseaux à chirurgie modèles fins | 78-79 | Clamps-pincés pour aorte | 537 |
| Ciseaux à chirurgie modèles standard | 72-77 | Clamps-pincés pour coarctation ATRAUMATIC-GRIP | 557 |
| Ciseaux à chirurgie modèles standard DURACUT | 46 | Clamps-pincés pour fémorale | 534 |
| Ciseaux à détroncation | 109 | Clamps-pincés pour hémorroïdes | 410 |
| Ciseaux à dissection | 81-93, 98 | Clamps-pincés pour la carotide | 527 |
| Ciseaux à dissection avec grands anneaux ergonomiques | 88 | Clamps-pincés pour la carotide ATRAUMATIC-GRIP | 524 |
| Ciseaux à dissection des nerfs | 93 | Clamps-pincés pour l'intestin et l'estomac | 403 |
| Ciseaux à dissection DURACUT | 47-54 | Clamps-pincés pour occlusion tangentielle | 562 |
| Ciseaux à dissection et à chirurgie | 81-83 | Clamps-pincés pour pédicules rénaux | 191 |
| Ciseaux à envies | 16 | Clamps-pincés pour péritoine | 192-193 |
| Ciseaux à épisiotomie DURACUT | 60 | Clamps-pincés pour veine cave ATRAUMATIC-GRIP | 550 |
| Ciseaux à fendre les ongles | 81 | Clamps-pincés universelles | 520-523, 530, 562 |
| Ciseaux à incision | 80 | Clamps-pincés universelles ATRAUMATIC-GRIP | 553-554 |
| Ciseaux à ligaments larges DURACUT | 60 | Clamps-pincés vasculaires périphériques | 534 |
| Ciseaux à ligatures | 352-353 | Clamps-pincés vasculaires périphériques ATRAUMATIC-GRIP | 535-536 |
| Ciseaux à lobectomie et pour le rectum | 99 | Clamps Bulldog | 163, 556 |
| Ciseaux à ongles | 16 | Clamps Bulldog avec denture DE BAKEY ATRAUMATIC-GRIP | 525-528 |
| Ciseaux à pansements | 672-673 | Clamps Bulldog TITAN-LINE | 160-161 |
| Ciseaux à périnée (à épisiotomie) | 107 | Clamps Bulldog, Pince pour poser et retirer | 527 |
| Ciseaux chirurgicaux fins | 68-70 | Clamps Micro Bulldog | 162 |
| Ciseaux coronaires | 95 | Clamps patent-ductus avec denture DE BAKEY ATRAUMATIC-GRIP | 531 |
| Ciseaux DURACUT à iridectomie | 45 | Clamps pour anastomose | 402 |
| Ciseaux fins à dissection | 92-93 | Clamps pour le cordon ombilical | 486 |
| Ciseaux fins à dissection avec grands anneaux ergonomiques | 92 | Clamps rénaux | 190 |
| Ciseaux fins à dissection et à ténotomie | 92 | CLAR Eclairer frontal complet | 11 |
| Ciseaux fins DURACUT | 45 | Clef plate pour étrier à extension | 659 |
| Ciseaux fistule et vasculaire DURACUT | 45 | Clés à vis pour scie oscillante | 681 |
| Ciseaux nasaux | 101-102 | CLEVELAND Pincés coupantes | 637 |
| Ciseaux nasaux DURACUT | 58 | Clips vasculaires, Applicateurs | 154-155 |
| Ciseaux pour ailes du nez | 81 | Clips vasculaires, Pincés | 156 |
| Ciseaux pour cartilage | 82 | Cloison des fosses nasales, Ciseaux | 102 |
| Ciseaux pour chirurgie plastique | 70, 82 | Cloison nasale, Aiguilles | 328 |
| Ciseaux pour chirurgie rectale DURACUT | 59 | Clous | 654 |
| Ciseaux pour gencive | 94 | CLOWARD Ecarteurs pour colonne cervicale | 285 |
| Ciseaux pour gencive DURACUT | 55 | CLOWARD Ecarteurs pour corps vertébraux | 296 |
| Ciseaux pour gynécologie DURACUT | 60 | COAKLEY Trocart pour la ponction du sinus maxillaire | 319 |
| Ciseaux pour interventions en profondeur | 106 | Coarctation, Pincés-clamps avec denture COOLEY | 557 |
| Ciseaux pour la chirurgie plastique DURACUT | 45 | Coarctation, Pincés-clamps avec denture DE BAKEY | 532-533 |
| Ciseaux pour la cloison des fosses nasales | 102 | COBB Gouge spinale | 616 |
| Ciseaux pour la neuro-chirurgie | 100 | COBB Rugines-raspatoires | 589 |
| Ciseaux pour la veine cave | 99 | COBB Rugines-raspatoires avec manche en „Ferrozell“ | 591 |
| Ciseaux pour le cordon ombilical | 108 | Col de l'utérus, Pincés pour abaissement | 452-456 |
| Ciseaux pour le nerf trigéminal | 100 | COLCLOUGH (LOVE-KERRISON) Pincés emporte-pièces à laminectomie | 710-711 |
| Ciseaux pour les amygdales | 103 | COLLER-CRILE Pincés hémostatiques fines | 167 |
| Ciseaux pour opérations | 80 | COLLIER Porte-aiguilles | 363 |
| Ciseaux pour septum DURACUT | 59 | COLLIN-BABY Ecarteur abdominal | 297 |
| Ciseaux utérins | 104-106 | COLLIN-DUVAL Pince intestinale | 149 |
| Ciseaux utérins DURACUT | 60 | COLLIN-DUVAL Pincés à préhension de l'intestin | 386 |
| Ciseaux vasculaires | 95-98 | COLLIN-FARABEUF Rugines-raspatoires | 588 |
| Ciseaux vasculaires DURACUT | 56-57 | | |

- COLLIN-HARTMANN** Ecarteur double 229
COLLIN-LANDAU Spéculum vaginaux 431
COLLIN ATRAUMATIC-GRIP Pincés à préhension de l'intestin 389
COLLIN Clamp pour le cordon ombilical 486
COLLIN Dynamomètre pour adultes 6
COLLIN Ecarteurs abdominaux 297-298
COLLIN Ecarteurs doubles 227
COLLIN Maillets 617
COLLIN Pince à préhension de l'intestin 386
COLLIN Pince à retirer les agrafes 379
COLLIN Pince hystérolabe 458
COLLIN Pince tire-langue 23
COLLIN Pincés à pansements et tampons 207
COLLIN Spéculum vaginaux 431
 Colonne cervicale, Ecarteurs 285
 Colonne vertébrale, Ecarteurs 288, 290-292
 Combinaison couvercle/pince 735
 Compas 7
 Compresses, Pincés 200-202
 Compresseur de l'urètre 426
 Compressif, Appareil 570
 Compressif, Tube 570
 Compressive, Bande 570
 Conducteur porte-tampon 447
 Conducteur pour scies 687
 Conducteurs à tendons 646, 648
CONE Pince crânienne 688
CONTOUR SCALP Ecarteurs autostatiques 276
CONVERSE GILLIES Crochets à peau 216
CONVERSE TITE-GRIP Porte-aiguilles 342
COOLEY-BECK ATRAUMATIC-GRIP Pincés-clamps à anastomose 560
COOLEY-DERRA ATRAUMATIC-GRIP Pincés-clamps à anastomose 559
COOLEY-REYNOLDS ATRAUMATIC-GRIP Pincés-clamps à anastomose 559
COOLEY ATRAUMATIC-GRIP Pincés-clamps à anastomose 560
COOLEY ATRAUMATIC-GRIP Pincés-clamps pour coarctation 557
COOLEY ATRAUMATIC-GRIP Pincés vasculaires 555
COOLEY Canules d'aspiration 327
COOLEY Clamps Bulldog 556
COOLEY Clamps patent-ductus droit 556
COOLEY Dilatateur aortique 511
COOLEY Dilatateurs vasculaires 510
COOLEY Ecarteur à sternotomie 499
COOLEY Ecarteurs à sternotomie en ALUMINIUM 498
COOLEY Ecarteurs atrium 509
COOLEY Pince-clamp périphérique 558
COOLEY Pince-clamp pour anévrisme de l'aorte 561
COOLEY Pince-clamp pour aorte 561
COOLEY Pincés-clamps iliaques 558
COOLEY Pincés-clamps pour occlusion tangentielle 562
COOLEY Pincés-clamps universelles 562
COOLEY Pincés hémostatiques rénales 558
COOPER Aiguille à ligatures 374
 Cordon ombilical, Ciseaux 108
 Cordon ombilical, Clamps 486
 Cordon, Pince pour fixer 425
 Coronaire, Ciseaux 95
 Corps vertébraux, Ecarteurs 296
CORWIN-HEGAR TITE GRIP Pince serre-fils 662
CORYLLOS Ecarteurs et spatules pulmonaires 261
 Coservation et stérilisation, Boîtes 738
 Costales, Rugines 495
 Costotomes 492-493
 Côtes, Ecarteurs 502-508
 Côtes, Ecarteurs en ALUMINIUM 500-502
 Côtes, Rapprocheurs 508
COTTLE-NEIVERT Crochet nasal 221
COTTLE Ciseaux nasaux DURACUT 102
COTTLE Ciseaux nasaux DURACUT 58
COTTLE Crochet à peau 217
COTTLE Crochet pour la chirurgie plastique 218
COTTLE Maillets 620
COTTLE Ostéotomes 608
COTTLE Râpe 593
COTTLE Rugines-raspatoires 583, 585
 Coupantes, Pincés 637-639
 Coupe-fils, Pincés 665-666
 Coupes limes 595
 Coupes râpes 595
 Coussin en caoutchouc de rechange pour bandeau frontal de **CLAR** 11
 Couteau à cerveau 40
 Couteau à lobe 39
 Couteau à périoste 39
 Couteau à phalanges 39
 Couteau interosseux 39
 Couteau pour la tunique interne 513
 Couteaux à amputation 38
 Couteaux à autopsie 40
 Couteaux à résection 38
 Couteaux à résection et amputation 39
 Couteaux pour appareils pâtés 679
 Couteaux pour dure-mère 37
 Couteaux pour vaisseaux 694-695
 Couvercle/pince, Combinaison 735
 Crachoir 751
CRAFOORD-DE BAKEY ATRAUMATIC-GRIP Pincés-clamps pour anévrisme de l'aorte 546
CRAFOORD-STILLE Pincés hémostatiques fines 170
CRAFOORD (STELZNER) Ciseaux à lobectomie et pour le rectum 99
CRAFOORD Pincés-clamps auriculaires 564
CRAFOORD Pincés hémostatiques fines 171
CRAIG-KOLGER Set pour la biopsie vertébrale 720-721
 Crâne, Ecarteurs autofixants 702
 Crâne, Instruments pour l'ouverture 687
 Crânienne, Pince 688
 Crâniens, Rongeurs 688
 Cranioclaste 485
 Crayons et Appareil pour marquer et écrire sur métal, verre, plastique etc. 757
CRILE-BABY Pincés hémostatiques fines 166
CRILE-COLLER Pincés hémostatiques fines 167
CRILE-MICRO Pincés hémostatiques fines 166
CRILE-MURRAY Porte-aiguilles 366
CRILE-RANKIN-DE BAKEY Pincés hémostatiques fines 167
CRILE-RANKIN (OCHSNER-DIXON) Pincés hémostatiques fines 167
CRILE-RANKIN Pincés hémostatiques fines 167
CRILE-WOOD Porte-aiguilles 366, 368
CRILE-WOOD TITE GRIP Porte-aiguilles 343
CRILE-WOOD TITE GRIP Porte-aiguilles pour gauchers 341
CRILE Crochets à nerfs et à vaisseaux 214
CRILE Ecarteur double 227
CRILE Pincés hémostatiques fines 166
CRILE Pincés hémostatiques fines en TITANE 166
CRILE Porte-aiguilles 371
 Crochet double pour saisir et soulever la peau, les tissus 212
 Crochet en bulbus 422
 Crochets 287, 289, 449, 696
 Crochets à microchirurgie 212
 Crochets à molle pour fixer la galea 691
 Crochets à nerfs et à vaisseaux 213-215
 Crochets à peau 216-217
 Crochets à plaies 218
 Crochets de galea 691
 Crochets de traction 659
 Crochets nasaux 221
 Crochets pour décapitation 485
 Crochets pour décompression 701
 Crochets pour fistules 221
 Crochets pour la chirurgie plastique 217-218
 Crochets pour la dure-mère 212, 217-218
CRUTCHFIELD Alésoir pour étrier traction crânienne de **CRUTCHFIELD** 689
CRUTCHFIELD Etrier traction crânienne 689
 Cuiller pour vésicule biliaire 417
 Cuillère pour médicaments 751
 Cuillère pour prélèvements des sécrétions 425
 Cuir chevelu, Pince 481
CULLEN-WERTHEIM Pincés-clamps pour pédicules rénaux 191
 Cupules 749
 Curette-sonde pour vésicule biliaire 415
 Curettes 598-606, 692
 Curettes à avortement et placenta 484
 Curettes à biopsie et d'aspiration 471
 Curettes d'aspiration 471
 Curettes pour biopsie 459-460
 Curettes pour biopsie endo-cervicale 460
 Curettes pour calculs biliaires 417
 Curettes pour les lupus 20
 Curettes tranchantes 695-696

| | |
|--|---------|
| Curettes utérines | 466-470 |
| CURTIS Pince chirurgicale | 147 |
| CUSCO Spéculum vaginal | 430-431 |
| CUSHING-FERRIS-SMITH Pincettes emporte-pièces à laminectomie | 713 |
| CUSHING-LANDOLT Spécule pour la hypophysectomie | 692 |
| CUSHING-TAYLOR Pince auriculaire et nasale | 136 |
| CUSHING-TAYLOR Pince fine à dissection | 131 |
| CUSHING-TAYLOR Pince fine chirurgicale | 143 |
| CUSHING-TAYLOR TITE GRIP Pince à dissection | 114 |
| CUSHING Crochet pour décompression | 701 |
| CUSHING Crochet pour la dure-mère | 218 |
| CUSHING Crochets à nerfs et à vaisseaux | 214 |
| CUSHING Ecarteurs à veines | 222-223 |
| CUSHING Perforateur | 652 |
| CUSHING Pince fine chirurgicale | 142 |
| CUSHING Pincettes emporte-pièces à laminectomie | 715 |
| CUSHING Pincettes fines à dissection | 130 |
| CUSHING Spatule cérébrale | 706 |
| CUSHING TITE GRIP Pincettes à dissection | 114 |
| Cuvettes | 749 |
| CUZZI Curettes à avortement et placenta | 484 |
| Cylindres pour seringues | 330-331 |
| Cylindriques, Récipients | 747 |
| CZERNY Pince pour abaissement du col de l'utérus | 455 |
| CZERNY Spéculum rectal | 405 |

D

| | |
|---|----------|
| DAHLGREN Rongeur crânien | 688 |
| DALE ATRAUMATIC-GRIP Pincettes-clamps vasculaires périphériques avec denture DE BAKEY | 535 |
| DANDY Crochets à nerfs et à vaisseaux | 214 |
| DANDY Pincettes hémostatiques fines | 165 |
| DARDIK ATRAUMATIC-GRIP Pincettes-clamps universelles | 554 |
| DARTIGUES Hystérolabe | 421 |
| DAUBENSPECK Curettes | 604 |
| DAVIDSON Ecarteurs à scapula | 260 |
| Daviers | 624-630 |
| Daviers à os | 493 |
| DAVIS-RAGNELL Ecarteurs pour la chirurgie plastique | 226 |
| DAVIS Spatules cérébrales | 706 |
| DAY Crochets à nerfs et à vaisseaux | 213 |
| DE BAKEY-BAINBRIDGE ATRAUMATIC-GRIP Pincettes vasculaires | 530 |
| DE BAKEY-BAHNSON ATRAUMATIC-GRIP Pincettes-clamps pour anévrisme de l'aorte | 545 |
| DE BAKEY-BECK ATRAUMATIC-GRIP Pincettes-clamps à anastomose | 543 |
| DE BAKEY-BECK ATRAUMATIC-GRIP Pincettes-clamps pour veine cave | 550 |
| DE BAKEY-BECK Pince-clamp pour aorte | 537 |
| DE BAKEY-CAROTIS ATRAUMATIC-GRIP Clamp Bulldog | 525 |
| DE BAKEY-CRAFOORD ATRAUMATIC-GRIP Pincettes-clamps pour anévrisme de l'aorte | 546 |
| DE BAKEY-CRILE-RANKIN Pincettes hémostatiques fines | 167 |
| DE BAKEY-DERRA ATRAUMATIC-GRIP Pincettes-clamps à anastomose | 542 |
| DE BAKEY-DIETRICH ATRAUMATIC-GRIP Clamps Bulldog | 526 |
| DE BAKEY-GLOVER ATRAUMATIC-GRIP Clamps Bulldog | 525 |
| DE BAKEY-GUYON Clamps rénaux | 190 |
| DE BAKEY-HALSTED-MOSQUITO Pincettes hémostatiques fines | 165 |
| DE BAKEY-HARKEN ATRAUMATIC-GRIP Pincettes à disséquer et à ligatures | 551 |
| DE BAKEY-HEANEY (ROGERS) Pincettes à hystérectomie | 197 |
| DE BAKEY-MORRIS ATRAUMATIC-GRIP Pincettes-clamps pour aorte | 540 |
| DE BAKEY-PEAN ATRAUMATIC-GRIP Pincettes vasculaires | 529 |
| DE BAKEY-PEAN Pincettes hémostatiques | 176 |
| DE BAKEY-POTTS Patent-ductus, Clamps ATRAUMATIC-GRIP | 531 |
| DE BAKEY-REYNOLDS ATRAUMATIC-GRIP Pincettes-clamps à anastomose | 542 |
| DE BAKEY-RUMEL Pincettes à disséquer et à ligatures | 186 |
| DE BAKEY-SATINSKY ATRAUMATIC-GRIP Clamps Bulldog | 525 |
| DE BAKEY-SATINSKY ATRAUMATIC-GRIP Pincettes vasculaires pour occlusion tangentielle | 541 |
| DE BAKEY-WERTHEIM (ROGERS) Pincettes à hystérectomie | 197 |
| DE BAKEY (GARRETT) Dilatateurs vasculaires | 510 |
| DE BAKEY ATRAUMATIC-GRIP Clamps Bulldog | 526, 528 |
| DE BAKEY ATRAUMATIC-GRIP Clamps patent-ductus | 531 |
| DE BAKEY ATRAUMATIC-GRIP Pince-clamp pour aorte | 539 |
| DE BAKEY ATRAUMATIC-GRIP Pincettes-clamps pour anévrisme de l'aorte | 545, 547 |
| DE BAKEY ATRAUMATIC-GRIP Pincettes-clamps pour coarctation | 532-533 |

| | |
|---|-------------------|
| DE BAKEY ATRAUMATIC-GRIP Pincettes-clamps universelles | 553 |
| DE BAKEY ATRAUMATIC-GRIP Pincettes-clamps vasculaires périphériques | 535-536 |
| DE BAKEY ATRAUMATIC-GRIP Pincettes à disséquer et à ligatures | 551 |
| DE BAKEY ATRAUMATIC-GRIP Pincettes vasculaires | 135 |
| DE BAKEY ATRAUMATIC-GRIP Pincettes vasculaires | 529-530 |
| DE BAKEY ATRAUMATIC-GRIP Pincettes vasculaires pour occlusion tangentielle | 541 |
| DE BAKEY Canule d'aspiration | 325 |
| DE BAKEY Ciseaux à artériotomie | 95 |
| DE BAKEY Ciseaux vasculaires | 96 |
| DE BAKEY Ciseaux vasculaires DURACUT | 57 |
| DE BAKEY Ecarteurs à côtes | 504, 505 |
| DE BAKEY Pince hémostatique rénale | 537 |
| DE BAKEY Pincettes-clamps universelles | 530 |
| DE BAKEY Pincettes-clamps vasculaires périphériques | 534 |
| DE BAKEY TITE GRIP Pincettes pour saisir les tissus et tirer les aiguilles | 116 |
| DE BAKEY TITE GRIP Porte-aiguilles | 343 |
| DE MARTEL-WOLFSON Clamps pour anastomose | 402 |
| DE MARTEL-WOLFSON Pince pour fermer les clamps | 402 |
| DE MARTEL Conducteur pour scies | 687 |
| DE MARTELL-WOLFSON Porte-clamps | 402 |
| DE VILBISS Rongeur crânien | 688 |
| DE VILBISS Spéculum vaginal | 433 |
| DEAN Ciseaux pour gencive DURACUT | 55 |
| DEAN Ciseaux pour les amygdales | 103 |
| DEAVER-FORD Ecarteur et spatule pulmonaire | 263 |
| DEAVER Ciseaux à chirurgie | 71 |
| DEAVER Ecarteurs et spatules pulmonaires | 264-265 |
| Décapitation, Crochet | 485 |
| Déchets, Pincettes | 735 |
| Décompression, Crochets | 701 |
| DEJERINE Marteaux à réflexes | 2 |
| DEMEL Aiguilles passe-fils | 660 |
| DENHARDT Ouvre-bouches | 22 |
| DENIS-BROWNE Ecarteur abdominal | 305 |
| DENKER-JECKERMANN Trocarts pour la trachéotomie avec canule argent | 728 |
| Dentaires, récipient à prothèses | 751 |
| Deponettes | 738 |
| Dépresseur utérin | 447 |
| DERF Porte-aiguilles | 363 |
| DERF TITE GRIP Porte-aiguilles | 342 |
| Dermatomes | 41, 42 |
| DERRA-COOLEY ATRAUMATIC-GRIP Pincettes-clamps à anastomose | 559 |
| DERRA-DE BAKEY ATRAUMATIC-GRIP Pincettes-clamps à anastomose | 542 |
| DESCHAMPS Aiguilles à ligatures | 374-376 |
| DESJARDINS Dilatateurs à voies biliaires | 415 |
| DESJARDINS Pincettes pour calculs biliaires | 419 |
| DESMARRES Ecarteurs à veines | 222 |
| Détergent pour instruments | 733 |
| Détroncation, Ciseaux | 109 |
| DEUCHER Ecarteur abdominal | 299 |
| DEVIN ATRAUMATIC-GRIP Pincettes-clamps pour la carotide avec denture LAWTON | 524 |
| Diapasons | 4 |
| Diapasons pour neurologie | 4 |
| DIEFFENBACH Clamps Bulldog | 163 |
| DIETRICH-DE BAKEY ATRAUMATIC-GRIP Clamps Bulldog | 526 |
| DIETRICH-HEGEMANN Ciseaux vasculaires | 96 |
| DIETRICH-HEGEMANN Ciseaux vasculaires DURACUT | 56 |
| DIETRICH ATRAUMATIC-GRIP Pince-clamp pour aorte avec denture DE BAKEY | 539 |
| DIETRICH Ciseaux vasculaires | 97 |
| DIETRICH Micro Clamps Bulldog | 162 |
| DIETRICH TITE GRIP Micro-Porte-aiguilles | 339 |
| Dilatateur vésicale | 423 |
| Dilatateurs à voies biliaires | 415 |
| Dilatateurs aortiques | 511 |
| Dilatateurs biliaires | 416 |
| Dilatateurs du col de l'utérus | 443-445 |
| Dilatateurs et spatules pour la tunique interne | 512 |
| Dilatateurs pour anus et rectum | 407-408 |
| Dilatateurs pour la trachéotomie | 728 |
| Dilatateurs vasculaires | 510 |
| Dilatation, bougies | 424 |
| DINGMANN Daviers | 624 |
| Disques de fixation avec fente | 659 |
| Dissecteurs | 574, 693, 696-697 |

- Dissecteurs pour la dure-mère 698-700
 Dissection des poumons, Pincés 149
 Dissection et à ligatures, Pincés 564
 Dissection et à ligatures, Pincés avec denture **DE BAKEY ATRAUMATIC-GRIP** 551
 Dissection et ténatomie, Ciseaux fins 92
 Dissection, Ciseaux 81-93, 98
 Dissection, Ciseaux **DURACUT** 47-54
 Dissection, Pincés 132-134
 Dissection, Pincés fines 128-131
 Dissection, Pincés **TITE GRIP** 113-115, 117
 Dissection, **TITE-GRIP** Pincés à dissection à griffes 117
 Dissection, **TITE-GRIP** Pincés modèles standard 115
 Disséquer et ligatures, Pincés 180-189
 Distributeurs de broches 656
 Distributeurs de broches filiformes 657
 Distributeurs de broches 752
DITTEL Mandrin pour sondes 425
DIU-Pincés 447
DIXON-LOVELACE Pincés hémostatiques fines 169
DIXON-UCHSNER CRILE-RANKIN Pincés hémostatiques fines 167
DOCKHORN Ecarteurs 245
 Doigts, Ecarteurs 271
 Double griffe pour extraction des tissus moux 721
DOUGLAS-BOZEMANN Pincés à pansements 208
DOUGLAS Pince à épiler 152
DOUGLAS Trocarts pour le sinus maxillaire 320
DOYEN-BABY ATRAUMATIC-GRIP Pincés-clamps intestinales 391
DOYEN-STILLE Ecarteurs 247
DOYEN ATRAUMATIC-GRIP Pincés-clamps intestinales 392-393
DOYEN Ciseaux pour interventions en profondeur 106
DOYEN Ecarteur intra abdominal 248-249
DOYEN Maillets 618
DOYEN Pince à compresses 200
DOYEN Pince à polypes et ovaires 457
DOYEN Rugines à costales 495
DOYEN Sonde cannelée 314
DOYEN Spéculum vaginaux 439
DOYEN Tracteurs pour fibrome 458
 Drains, Pincés à traire 203
DUBOIS Ciseaux à détroncation 109
DUPLAY Pince pour abaissement du col de l'utérus 453
DURACUT Ciseaux à chirurgie 46
DURACUT Ciseaux à chirurgie modèles standard 46
DURACUT Ciseaux à dissection 47-54
DURACUT Ciseaux à épisiotomie 60
DURACUT Ciseaux à iridectomie 45
DURACUT Ciseaux à ligaments larges 60
DURACUT Ciseaux adnex 54
DURACUT Ciseaux fins 45
DURACUT Ciseaux nasaux 58
DURACUT Ciseaux pour gencive 55
DURACUT Ciseaux pour gynécologie 60
DURACUT Ciseaux pour la chirurgie plastique 45
DURACUT Ciseaux pour septum 59
DURACUT Ciseaux utérins 60
DURACUT Ciseaux vasculaires 56-57
DURACUT Ciseaux vasculaires et pour fistules 45
DURACUT Pincés à couper le fil 667
DURANTE Pincés pour vaisseaux et tumeurs 149
 Dure-mère, Crochet 217-218
 Dure-mère, Dissecteurs 698-700
DUVAL-COLLIN Pince intestinale 149
DUVAL-COLLIN Pincés à préhension de l'intestin 386
DUVAL Pince intestinale 149
DUVAL Pincés à préhension de l'intestin 386-388
 Dynamomètre pour adultes 6
 Dynamomètres 6
- E**
- EASTMAN-RICHARDSON** Ecarteurs 250
EATON-BECKMANN Ecarteur pour laminectomie 280
 Ecarteur à goitre 224
 Ecarteur à poumons 260
 Ecarteur à veines et à hile rénal 223
 Ecarteur des côtes 508
 Ecarteur du pylore 403
 Ecarteur et rapprocheur 508
 Ecarteur pour la trachée 226
 Ecarteur pour mains 271
 Ecarteur rectal 408
 Ecarteur thoracique 507
 Ecarteurs 212-310
 Ecarteurs à côtes 502-507
 Ecarteurs à côtes en ALUMINIUM 500-502
 Ecarteurs à gaines tendineuses 225
 Ecarteurs à scapula 260
 Ecarteurs à sternotomie 499
 Ecarteurs à sternotomie en ALUMINIUM 498
 Ecarteurs à veines 217, 222-223
 Ecarteurs abdomiaux 297-309
 Ecarteurs atrium 509
 Ecarteurs autofixants au crâne 702
 Ecarteurs autofixants de **LEYLA**, accessoires 703, 705
 Ecarteurs autostatiques 270-276, 278, 282-283
 Ecarteurs doubles 226-231
 Ecarteurs du cerveau autofixants 704
 Ecarteurs et écarteurs à os 232
 Ecarteurs et spatules pulmonaires 261-265
 Ecarteurs intra abdominaux 248
 Ecarteurs **LEYLA**, Accessoires 705
 Ecarteurs pour appendicectomie 284
 Ecarteurs pour chirurgie lombaire 294-295
 Ecarteurs pour colonne cervicale 285
 Ecarteurs pour colonne vertébrale 288, 290-292
 Ecarteurs pour corps vertébraux 296
 Ecarteurs pour doigts 271
 Ecarteurs pour fixation à la table d'opération 704
 Ecarteurs pour genou 641
 Ecarteurs pour hemilaminectomie 277
 Ecarteurs pour interventions en profondeur 252-259
 Ecarteurs pour laminectomie 276, 279-280, 286
 Ecarteurs pour trachéotomie 217, 219-220, 728
 Ecarteurs prostatiques 422
 Ecarteurs spinaux 231
 Ecarteurs vésicaux 310
 Ecarteurs vulvaires 281
 Echardes, Pincés 150-151
ECHLIN Pincés-gouges 634
 Eclaireurs frontaux 11
 Eclaireurs frontaux pour courant à basse tension 11
 Ecouvillons 756
 Ecraseur et clamp à appendicectomie 403
 Ecraseurs intestinaux 403
EDER Porte-cotons 409
EICKEN-KILLIAN Canules d'irrigation 322
EICKEN (V.) LICHTWITZ Trocarts pour ponction du sinus maxillaire 319
EISELSBERG Ciseaux à ligatures 352
 Elévateurs 574-575
 Elévateurs pour la hanche 580
 Embouts pour pistolet-laveur à jet d'eau 755
EMMET Crochet 449
EMMET Crochet pour fistules 221
EMMET Pincés à pansements et tampons 207
 Emporte-pièce, Pincés à biopsie 460-465
 Endartérectomie, Jeu 515
 Endartérectomie, Sondes 514
 Endospéculum 443
ENGEL Scie pour appareils plâtrés 679
ENGL. MOD. Pincés à compresses 200
 Entonnoirs 751
 Entretien des instruments, Liquide concentré **PREP LUBE** 733
 Epiler, Pincés 152
 Epingles à instruments 736
 Episiotomie et périnée, Ciseaux 107
 Episiotomie, Ciseaux **DURACUT** 60
 Eponges et tampons, Pincés 209-210
ERRICO Fraise 652
ESMARCH Bande compressive 570
ESMARCH Cisailles pour étoffes d'habillement et appareils plâtrés 675
ESMARCH Couteau pour appareils plâtrés 679
ESMARCH Tube compressif 570
 Essuie-mains et broches, Paniers 753
 Estomac et intestin, Pincés-clamps 403
 Etiquettes d'identification, en couleur 743
 Etoffes d'habillement et appareils plâtrés, Cisailles 675

| | |
|---|--------------|
| Etoffes d'habillement et pansements, Cisailles | 674 |
| Etriers à extension | 654, 658-659 |
| Etriers traction crânienne | 689 |
| Etui pour infirmières | 18 |
| EUFRATE PASQUE TITE GRIP Porte-aiguilles | 344 |
| EWALD Pince fine chirurgicale | 140 |
| EWALD Pince fine pour dissection | 129 |
| Extension, Etriers | 654, 658-659 |
| Extraction des tissus moux, Double griffe | 721 |

F

| | |
|--|---------|
| FAHLBUSCH-HARDY Dissecteurs | 693 |
| FANSLER-IVES Anusscopes | 407 |
| FARABEUF-ALEXANDER Rugines à costales | 497 |
| FARABEUF-COLLIN Rugines-raspatoires | 588 |
| FARABEUF-LAMBOTTE Davier | 626 |
| FARABEUF Ecarteurs doubles | 227 |
| FARABEUF Rugines-raspatoires | 588 |
| FARELL LATHBURY Porte-cotons | 316 |
| FAURE Pincers-clamps pour péritoine | 193 |
| FAVALORO Ciseaux coronaires | 95 |
| FEHLAND ATRAUMATIC-GRIP Pincers-clamps à anastomose du rectum | 401 |
| FEILCHENFELD Pincers à échardes | 150 |
| FEIN Porte-cotons | 317 |
| Fémorale, Pincers-clamps | 534 |
| FERGUSON Aiguilles à sutures | 356 |
| FERGUSON Ciseaux pour opération | 80 |
| FERGUSON Davier | 624 |
| FERGUSON FRAZIER Canules d'aspiration | 323 |
| FERRIS-SMITH-CUSHING Pincers emporte-pièces à laminectomie | 713 |
| FERRIS-SMITH-KERRISON Pincers emporte-pièces à laminectomie | 709-711 |
| FERRIS-SMITH Pincers chirurgicales | 147 |
| Fibrome, Tracteurs | 458 |
| Fil d'argent pour fabriquer des agrafes | 690 |
| Fil pour ceilage | 660 |
| Fils, Catgut | 353 |
| Fils-coupe, Pincers | 665-666 |
| Fils-scies | 687 |
| FINOCHIETTO-BABY-HAIGHT Ecarteur à côtes en ALUMINIUM | 501 |
| FINOCHIETTO-BABY Ecarteur à côtes | 503 |
| FINOCHIETTO-BURFORD Ecarteurs à côtes | 503 |
| FINOCHIETTO-BURFORD Ecarteurs à côtes en ALUMINIUM | 502 |
| FINOCHIETTO-INFANT Ecarteur à côtes en ALUMINIUM | 501 |
| FINOCHIETTO-RIENHOFF Ecarteur à côtes | 506 |
| FINOCHIETTO Ecarteurs à côtes | 503 |
| FINOCHIETTO Ecarteurs à côtes en ALUMINIUM | 501 |
| FINOCHIETTO modif. Ecarteurs à côtes en ALUMINIUM | 500 |
| FINOCHIETTO Pince thoracique et pour ligatures | 564 |
| FINOCHIETTO Porte-aiguilles | 369 |
| FINOCHIETTO TITE-GRIP Porte-aiguilles | 346 |
| FINSEN Ecarteurs autostatiques | 270 |
| FISCH Crochet pour la dure-mère | 212 |
| FISCHER Strippers à tendons | 646 |
| Fistules et vasculaires, Ciseaux | 80 |
| Fistules, Crochets | 221 |
| Fistules, Sondes | 314 |
| Fistules, Sondes | 409 |
| Fixation, Bases | 703 |
| FLETCHER (JAVERTS) Pince à tampons et éponges | 210 |
| FLUHRER Sonde boutonée | 313 |
| FOERSTER-BALLENGER Pincers à tampons et éponges | 209 |
| FOERSTER Ecarteur abdominal en VINYL | 308 |
| FOERSTER FORBES Pincers à tampons et éponges | 210 |
| FOERSTER Valves en VINYL pour écarteur abdominal | 308 |
| FOMOM Ciseaux nasaux DURACUT | 58 |
| FOMON Ciseaux nasaux | 102 |
| FOMON Ciseaux pour ailes du nez | 81 |
| FOMON Ciseaux pour chirurgie plastique | 82 |
| FOMON Crochets nasaux | 221 |
| FOMON TITE-GRIP Râpes | 597 |
| FORBES (FOERSTER) Pince à tampons et éponges | 210 |
| Forceps | 478-480 |
| FORD-DEAVER Ecarteur et spatule pulmonaire | 263 |
| FOSS Ecarteur et spatule pulmonaire | 263 |
| Fourche à fil | 694 |
| Fourchette pour implants | 693 |
| FOX-GOLDMANN Ciseaux pour gencive | 94 |

| | |
|--|-----|
| FOX-GOLDMANN Ciseaux pour gencive DURACUT | 55 |
| FOX Curettes pour les lupus | 20 |
| FRANZ Ecarteur abdominal | 304 |
| FRAZIER (FERGUSON) Canules d'aspiration | 323 |
| FRAZIER Canules d'aspiration | 323 |
| FRAZIER Crochet à peau | 216 |
| FRAZIER Dissecteur pour la dure-mère | 698 |
| FREER Ciseaux-burins | 607 |
| FREER Ecarteur | 218 |
| FREER Rugines-raspatoires | 583 |
| FRENCH EYE TITE GRIP Porte-aiguilles | 340 |
| FRENZEL Abaisse-langue | 12 |
| FREY-SAUERBRUCH Costotome | 493 |
| FRIEDMAN-LUER Pince-gouge | 631 |
| FRITSCH Ecarteurs | 250 |
| FROHN Porte-cotons | 316 |
| FRYKHOLM Pincers-gouges | 635 |

G

| | |
|--|------------------------|
| Gaines tendineuses, Ecarteurs | 225 |
| Galea, Crochets | 691 |
| Galea, Crochets à molle pour fixer | 691 |
| GALLAHER Râpe | 592 |
| GANSKE-BIRCHER Pincers à ménisque et cartilage | 640 |
| GARRETT-DE BAKEY Dilatateurs vasculaires | 510 |
| Gauchers, Porte-aiguilles TITE GRIP | 341 |
| GAYLOR-THOMS Pince emporte-pièces à biopsie | 460 |
| GEISSENDOERFER -OVERHOLT Pincers à disséquer et à ligatures | 184 |
| GELPI-BABY Ecarteur vulvaire | 281 |
| GELPI-SELETZ Ecarteur vulvaire | 281 |
| GELPI Ecarteurs vulvaires | 281 |
| GEMINI-MIXTER Pincers à disséquer et à ligatures | 181 |
| GEMINI Pincers à disséquer et à ligatures | 181 |
| Gencive, Ciseaux | 94 |
| Gencive, Ciseaux DURACUT | 55 |
| Genou, Ecarteurs | 641 |
| GERALD Pince fine chirurgicale | 142 |
| GERALD Pincers fines pour dissection | 130 |
| GERALD TITE GRIP Pince à dissection | 114 |
| GERALD TITE GRIP Pince à dissection à griffes | 117 |
| GERSTER Davier | 630 |
| GERZOG Maillets | 618 |
| GIBBON-BAILEY Rapprocheur de côtes | 508 |
| GIERTZ-STILLE Costotome | 492 |
| GIGLI (OLIVECRONA) Fils-scies | 687 |
| GIGLI Poignées pour scies | 687 |
| GIL-VERNET MARBERGER Ecarteur à veines et à hile rénal | 223 |
| GILLIES-BABY Porte-aiguilles avec ciseaux | 370 |
| GILLIES-BABY TITE GRIP Porte-aiguilles | 348 |
| GILLIES (CONVERSE) Crochets à peau | 216 |
| GILLIES Crochets à peau | 216 |
| GILLIES Pince fine chirurgicale | 142 |
| GILLIES Porte-aiguilles avec ciseaux | 370 |
| GILLIES TITE GRIP Pince à dissection à griffes | 117 |
| GILLIES TITE GRIP Porte-aiguilles | 348 |
| GLASSMANN KILNER Ciseaux à chirurgie et à dissection | 83 |
| GLOVER-DE BAKEY ATRAUMATIC-GRIP Clamps Bulldog | 525 |
| GLOVER ATRAUMATIC-GRIP Pincers-clamps à anastomose avec denture DE BAKEY | 544 |
| GLUCK Costotome | 492 |
| Gobelets gradués | 751 |
| Goblet | 737, 751 |
| GOELET Ecarteur double | 229 |
| Goitre, Ecarteur | 224 |
| GOLDMANN-FOX Ciseaux pour gencive | 94 |
| GOLDMANN-FOX Ciseaux pour gencive DURACUT | 55 |
| Goniomètre | 7 |
| Goniomètre pour les membres | 7 |
| GOOD Ciseaux pour les amygdales | 103 |
| GOODELL Dilatateur du col de l'utérus | 443 |
| GORNEY Ciseaux pour chirurgie plastique | 82 |
| GORNEY Ciseaux pour septum DURACUT | 59 |
| GOSSET-BABY Ecarteur abdominal | 299 |
| GOSSET Ecarteurs abdominaux | 299-300 |
| Gouge spinale | 616 |
| Gouges | 607, 609-610, 612, 614 |
| Gouges avec manche en „Ferrozell“ | 615-616 |

- Gouges et ciseaux-burins avec manche en „Ferrozell“ 614
 Gouges et ostéotomes avec manche en „Ferrozell“ 612
 Gouges, ostéotomes et ciseaux-burins avec manche en „Ferrozell“ 611-613
 Gouges, Pincés 631-636
GOURDET Curettes utérines 466
GRAEFE (TYRELL) Crochets à peau 216
GRAEFE Crochets à nerfs et à vaisseaux 213
GRAEFE Pince chirurgicale 148
GRAEFE Pincés fines à dissection 128
GRAEFE Pincés fines chirurgicales 139
GRAHAM Crochet pour la dure-mère 217
GRAMCKO-BUCK Levier à os 576
 Grattoir pour lupus 19
GRAVE modif. Spéculum vaginal 432
GRAVE Spéculum vaginaux 432-433
GREEN-ARMYTAGE Pince-clamp utérine pour hémostase 481
GREEN-SENN Ecarteurs 224
GREEN Ecarteurs 243
GREEN Pince à compresses 200
 Greffons-chasse 606
GREGORY-SOFT ATRAUMATIC-GRIP Clamps Bulldog
 avec denture **DE BAKEY** 527
GREGORY-SOFT Pincés-clamps pour la carotide 527
GREGORY Pincés-clamps pour fémorale 534
 Griffes (double) pour extraction des tissus moux 721
GRONINGEN Crochets à nerfs et à vaisseaux 215
GROSS Pincés à pansements et tampons 204
GRUENWALD-LOVE Pincés emporte-pièces à laminectomie 716
GRUENWALD (JANSEN) Pince auriculaire et nasale 136
GRUENWALD Pincés auriculaires et nasales 136
 Guides-pincés 650
GUNNAR-HEY Pince à traire les drains 203
GUTHRIE Crochets à plaies 218
GUYON -DE BAKEY Clamps rénaux 190
GUYON Clamps rénaux 190
GUYON Mandrin pour sondes 425
GUYON Mandrin pour sondes en gomme 425
 Gynécologie, Ciseaux DURACUT 60
- ## H
- HABERER** Spatules abdominaux et intestinaux 267
HAIGHT-BABY-FINOCCHIETTO Ecarteur à côtes en ALUMINIUM 501
HAIGHT Ecarteur à côtes 506
HAJEK-KOFLER Pincés emporte-pièces à laminectomie 708
HAJEK Maillets 617
HALLE Couteau pour dure-mère 37
HALLE Curettes 604
HALLE Rugine-raspatoire 582
HALLE Spatule pour la tunique interne 512
HALSEY Porte-aiguilles 363
HALSEY TITE GRIP Porte-aiguilles 342
HALSEY TITE GRIP Porte-aiguilles pour gauchers 341
HALSTED-MICRO Pincés hémostatiques fines 164
HALSTED-MOSQUITO-DE BAKEY Pincés hémostatiques fines 165
HALSTED-MOSQUITO HEISS Pincés hémostatiques fines 170
HALSTED-MOSQUITO Pincés hémostatiques fines 164-165
HALSTED Pincés hémostatiques fines 169, 171
 Hanche, Elévateurs 580
HARDY-FAHLBUSCH Dissecteurs 693
HARDY Curettes 692
HARDY Enucléateurs 693
HARDY Fourchette pour implants 693
HARKEN-DE BAKEY ATRAUMATIC-GRIP Pincés à
 disséquer et à ligatures 551
HARRINGTON-MAYO Ciseaux à dissection 86
HARRINGTON Ecarteurs et spatules pulmonaires 262
HARTMANN-COLLIN Ecarteur double 229
HARTMANN BABY-MOSQUITO Pincés hémostatiques fines 164
HARTMANN Diapason 4
HARTMANN Pincés emporte-pièces à biopsie 462
HARTMANN Sondes auriculaires 322
HASSETTINE Clamp pour le cordon ombilical 486
HAVERFIELD-SCOVILLE Ecarteur pour laminectomie 286
HAYES ATRAUMATIC-GRIP Pince-clamp à anastomose du rectum 400
HEANEY-BALLENTINE Pince à hystérectomie 196
HEANEY-DE BAKEY (ROGERS) Pincés à hystérectomie 197
HEANEY-REZEK Pincés à hystérectomie 196
HEANEY-SIMON Ecarteur pour interventions en profondeur 254
HEANEY Pincés à hystérectomie 196
HEANEY Pincés chirurgicales 147
HEANEY Porte-aiguilles 369
HEANEY TITE GRIP Porte-aiguilles 346
HEATH-RICHTER Pince à retirer les agrafes 379
HEATH Maillet 620
HEGAR-BAUMGARTNER TITE GRIP Porte-aiguilles 342
HEGAR-CORWIN TITE GRIP Pince serre-fils 662
HEGAR-MAYO Porte-aiguilles 367
HEGAR-MAYO TITE GRIP Porte-aiguilles 345
HEGAR-MAYO TITE GRIP Porte-aiguilles pour gauchers 341
HEGAR-OLSEN-BABY TITE GRIP Porte-aiguilles 348
HEGAR-OLSEN Porte-aiguilles avec ciseaux 370
HEGAR-OLSEN TITE GRIP Porte-aiguilles 348
HEGAR Dilatateurs du col de l'utérus 444
HEGAR Jeux de dilateurs du col de l'utérus 445
HEGEMANN-DIETRICH Ciseaux vasculaires 96
HEGEMANN-DIETRICH Ciseaux vasculaires DURACUT 56
HEIFETZ Pincés pour saisir tumeurs et tissus 127
HEIFETZ Spatules cérébrales 706
HEISS (HALSTED-MOSQUITO) Pincés hémostatiques fines 170
HEISS MIXTER-PAUL Pincés à disséquer et à ligatures 182
HEISTER Ouvre-bouches 22
 Hémi laminectomie, Ecarteurs 277
HEMINGWAY Curettes 599
 Hémorroïdaux, Ligateurs 410
 Hémorroïdes, Ligateurs aspirateurs 411
 Hémorroïdes, Pincés-clamps 410
 Hémostase, Pince-clamp utérine 481
 Hémostatiques et pour amygdales, Pincés 179
 Hémostatiques rénales, Pincés 537, 558
 Hémostatiques, Pincés 173-178
 Hémostatiques, Pincés fines 164-172
 Hémostatiques, Pincés fines en TITANE 164, 166, 168
HENLEY Ecarteurs autostatiques 282-283
HENNING Pince écartante à plâtre 682
HERRICK Pincés-clamps pour pédicules rénaux 191
HEY-GUNNAR Pince à traire les drains 203
HEYMANN Ciseaux nasaux 101
HEYMANN Ciseaux nasaux DURACUT 58
HEYWOOD-SMITH Pince à polypes et ovaires 457
HEYWOOD-SMITH Pincés tire-langue 23
HIBBS Ecarteurs 231
HIBBS Ecarteurs spinaux 231
 Hile rénal et veines, Ecarteurs 223
HIRSCHMANN Anusscopes 407
HOEN Rugines-raspatoires 586
HOGLUND-LOWMAN Davier 630
HOHMANN-ALDINGER Levier à os 580
HOHMANN-LANGE Leviers à os 577
HOHMANN-MINI Leviers à os 576
HOHMANN Leviers à os 578-580
HOKE Ostéotomes 607
HOLSHER Rétracteur pour racines nerveuses 701
HOLZBACH Pincés à hystérectomie 194
HOPKINS-JOHN Clamps Bulldog 163
HOPKINS-JOHN Pince pour poser et retirer les clamps Bulldog 527
HOPKINS Couteau pour appareils plâtrés 679
HORGAN Ecarteurs abdominaux 303
HORNE-JOHNSON Porte-cotons 317
HORSLEY-KEY-LISTON Pince coupante à os 494
HORSLEY Dissecteur pour la dure-mère 698
HÖSEL Ecarteurs 246
HOSPITAL-PROVIDENCE Pincés hémostatiques fines 168
HOUSE Curettes 598
HOWARD Rugine-raspatoire 583
HRYNTSCHAK-YOUNG Porte-aiguilles boomerangs 372
HUDSON Perforateur à main 652
HULKA-KENWICK Pince pour abaissement du col de l'utérus 453
HULKA Pince pour abaissement du col de l'utérus 453
HUMBY Dermatome 42
HUNTER Pincés à échardes 150
HURD Aiguilles à ligatures 374
 Hypodermique, Aiguille 486
 Hypophyse, Pincés 719
 Hypophysectomie, Instruments 692-693
 Hypophysectomie, Spécule 692
 Hystérectomie, Pincés 194-197

| | |
|--|-----|
| Hystéro-salpingographie, Instrumentation | 474 |
| Hystérolabe | 421 |
| Hystérolabes, Pincés | 458 |
| Hystéromètre | 446 |

I

| | |
|--|------------------|
| Identifications, Etiquettes | 743 |
| Iliques, Pincés-clamps | 558 |
| Implants, Fourchette | 693 |
| Incision, Ciseaux | 80 |
| INFANT-FINOCHIETTO Ecarteur à côtes en ALUMINIUM | 501 |
| Infirmières, Articles | 751 |
| INGE Ecarteurs pour corps vertébraux | 296 |
| Instrumentation pour amnioscopie | 472-473 |
| Instrumentation pour hystéro-salpingographie | 474 |
| Instruments à ongles | 645 |
| Instruments à suture | 378, 690-691 |
| Instruments de circoncision | 426 |
| Instruments de mesure pour profondeur | 451 |
| Instruments pour biopsie osseuse | 669 |
| Instruments pour cerlage | 660 |
| Instruments pour examiner et mesurer | 6 |
| Instruments pour la chirurgie laser | 448-451 |
| Instruments pour la hypophysectomie | 692-693 |
| Instruments pour l'ouverture du crâne | 687 |
| Instruments pour l'urologie | 425-426 |
| Instruments pour mesurer | 7, 448 |
| Instruments pour mesurer la sensibilité | 4 |
| Instruments pour microchirurgie | 694-697 |
| Instruments pour obstétrique | 481 |
| Instruments pour prostatectomie | 423 |
| Instruments pour trachéotomie | 728-730 |
| Instruments, Boîtes | 746 |
| Instruments, Détergent | 733 |
| Instruments, Entretien, Liquide concentré PREP LUBE | 733 |
| Instruments, Epingles | 736 |
| Instruments, Plateaux | 748 |
| Interventions en profondeur, Ciseaux | 106 |
| Interventions en profondeur, Ecarteurs | 252-259 |
| Intestin et estomac, Pincés-clamps | 403 |
| Intestin, Pincés à préhension | 383-389 |
| Intestin, Pincés à préhension ATRAUMATIC-GRIP | 389 |
| Intestinales et anastomose, Pincés-clamps | 402 |
| Intestinales, Aiguilles | 354 |
| Intestinales, Pincés | 149 |
| Intestinales, Pincés-clamps | 390-394 |
| Intestinales, Pincés-clamps ATRAUMATIC-GRIP | 391-393, 395-396 |
| Intestinaux et abdominaux, Spatules | 266-267 |
| Intestinaux, Ecraseurs | 403 |
| Intra abdominaux, Ecarteurs | 248 |
| IOWA Aiguille à hypodermique | 486 |
| IOWA Aiguille trompette guide | 486 |
| IOWA Pince perce membrane | 477 |
| Iridectomie, Ciseaux DURACUT | 45 |
| Irrigateurs | 751 |
| Irrigation, Aiguilles vasculaires | 322 |
| Irrigation, Canules | 322 |
| ISRAEL Ecarteurs | 237 |
| IVES-FANSLER Anusscopes | 407 |

J

| | |
|---|-----|
| JACKSON-CHEVALIER Canules pour la trachéotomie | 726 |
| JACKSON Ecarteur pour la trachée | 226 |
| JACKSON Ecarteur pour trachéotomie | 217 |
| JACKSON Pince à saisir les tendons | 647 |
| JACKSON Spéculum vaginaux | 438 |
| JACOBS Pince pour abaissement du col de l'utérus | 456 |
| JACOBSON Couteau pour vaisseaux | 694 |
| JACOBSON Fourche à fil | 694 |
| JACOBSON Micro-ciseaux | 64 |
| JACOBSON Micro-Porte-aiguilles | 359 |
| JACOBSON Sonde boutonée | 694 |
| JACOBSON Sonde double | 694 |
| JACOBSON TITE GRIP Micro-Porte-aiguilles | 338 |
| JAMESON Porte-aiguilles | 368 |

| | |
|---|----------|
| JAMSON Ciseaux fins à dissection | 93 |
| JANET Cylindres pour seringues | 331 |
| JANET Seringues vésicales | 331 |
| JANSEN-ZAUFAL Pince-gouge | 633 |
| JANSEN Curette | 599 |
| JANSEN Ecarteurs autostatiques | 272 |
| JANSEN Eclairer frontal complet | 11 |
| JANSEN GRUENWALD Pince auriculaire et nasale | 136 |
| JANSEN Pince auriculaire et nasale | 136 |
| JANSEN Pincés-gouges | 632 |
| JANSEN Rugine-raspatoire | 587 |
| JAVERTS FLETCHER Pince à tampons et éponges | 210 |
| JAVID Pince-clamps pour la carotide | 537 |
| Jeu de trépan cutanés | 20 |
| Jeu d'instruments pour trachéotomie | 729-730 |
| Jeu pour endartérectomie | 515 |
| Jeu pour tunneler | 516 |
| Jeux de dilateurs biliaires | 416 |
| JOHN-HOPKINS Clamps Bulldog | 163 |
| JOHNS-HOPKINS Pince pour poser et retirer les clamps Bulldog | 527 |
| JOHNSON-HORNE Porte-cotons | 317 |
| JONES-LELAND Pincés-clamps vasculaires périphériques | 534 |
| JONES Pincés à compresses | 200 |
| JORGENSEN Ciseaux à dissection | 98 |
| JOSEPH Bistouris pour plastie du nez | 37 |
| JOSEPH Ciseaux pour chirurgie plastique | 70 |
| JOSEPH Crochet pour la chirurgie plastique | 217, 219 |
| JOSEPH DURACUT Ciseaux pour la chirurgie plastique | 45 |
| JOSEPH Lime à os | 597 |
| JOSEPH Rugine-raspatoire | 582 |
| JUDD-ALLIS Pincés à préhension de l'intestin | 384 |
| JUDD-MASSON Ecarteur vésical | 310 |

K

| | |
|---|----------|
| KADER Spatules abdominaux et intestinaux | 267 |
| KALLMORGEN Jeux de spéculums et valves vaginaux | 434 |
| KALT Aiguilles vasculaires | 354 |
| KALT Porte-aiguilles | 363 |
| KATSCH Tire-comédons | 19 |
| KAY-LAMBERT ATRAUMATIC-GRIP Pincés-clamps pour anastomose de l'aorte avec denture DE BAKEY | 549 |
| KAZANJIAN Pince coupante | 637 |
| KELLY-BABY Pincés hémostatiques fines | 168 |
| KELLY-RANKIN Pincés hémostatiques fines | 169 |
| KELLY Ciseaux vasculaires et pour fistules | 80 |
| KELLY DURACUT Ciseaux vasculaires et pour fistules | 45 |
| KELLY Ecarteur pour interventions en profondeur | 255 |
| KELLY Ecarteurs | 251 |
| KELLY Pince à polypes et ovaires | 457 |
| KELLY Pincés hémostatiques fines | 168 |
| KELLY Pincés hémostatiques fines en TITANE | 168 |
| KELLY Sphinctérosopes | 407 |
| KENWICK-HULKA Pince pour abaissement du col de l'utérus | 453 |
| KERN-LANE Davier | 625 |
| KERN-MINI Davier | 625 |
| KERRISON-LOVE (COLCLOUGH) Pincés emporte-pièces à laminectomie | 710-711 |
| KERRISON-SMITH-FERRIS Pincés emporte-pièces à laminectomie 709-711 | 707 |
| KERRISON Pincés emporte-pièces à laminectomie | 707 |
| KEVOURKIAN-PACIFIC Pince emporte-pièces à biopsie | 464 |
| KEVOURKIAN-YOUNGE Curettes pour biopsie | 459 |
| KEVOURKIAN-YOUNGE Pince emporte-pièces à biopsie | 463, 465 |
| KEY-LISTON-HORSLEY Pince coupante à os | 494 |
| KEY Rugines-raspatoires | 589 |
| KEYES Jeu de trépan cutanés | 20 |
| KEYES Trépan cutanés | 20 |
| KIELAND-LUIKART Forceps | 479 |
| KIELAND Forceps | 479 |
| KILLIAN-EICKEN Canules d'irrigation | 322 |
| KILLIAN MÜHLING Ciseaux pour cloison des fosses nasales | 102 |
| KILLIAN Rugines-raspatoires | 583 |
| KILNER (GLASSMANN) Ciseaux à chirurgie et à dissection | 83 |
| KILNER Ciseaux fins à dissection | 93 |
| KILNER Crochet à peau | 216 |
| KILNER TITE GRIP Porte-aiguilles | 342 |
| KIRK Maillets | 618 |
| KIRKLIN Ecarteurs à veines | 223 |

| | |
|--|---------------|
| KIRSCHNER Etriers à extension..... | 658-659 |
| KIRSCHNER, Broches | 655 |
| KIRSCHNER-BALFOUR Valves pour écarteurs abdominaux..... | 307 |
| KIRSCHNER Ecarteurs abdominaux | 306 |
| KIRSCHNER Valves pour écarteurs abdominaux..... | 307 |
| KLEINERT-KUTZ Pince passe-tendons..... | 649 |
| KLEINSCHMIDT Ecraseur et clamp à appendicectomie..... | 403 |
| KLIMA-ROSEGGER Aiguilles à ponction sternale | 329, 518 |
| KLINGENBERGH-LOTH Ciseaux à dissection | 98 |
| KNAPP Ciseaux chirurgicaux fins | 68 |
| KNAPP Ecarteurs | 218 |
| KNAPP Ecarteurs à gaines tendineuses | 225 |
| KNIGHT Ciseaux nasaux..... | 101 |
| KNIGHT Ciseaux nasaux DURACUT..... | 58 |
| KNOWLES Ciseaux à pansements | 673 |
| KNUTSON Uréthrographe | 426 |
| KOCHER-BABY ATRAUMATIC-GRIP Pincés-clamps intestinales | 391 |
| KOCHER-LANGENBECK Ecarteurs | 240 |
| KOCHER-OCHSNER Pincés hémostatiques | 177 |
| KOCHER ATRAUMATIC-GRIP Pincés-clamps intestinales..... | 395 |
| KOCHER Ecarteurs | 235, 242, 244 |
| KOCHER Ecarteurs et écarteurs à os | 232 |
| KOCHER Pincés-clamps intestinales | 392-394 |
| KOCHER Pincés hémostatiques | 176 |
| KOCHER Spatule vésicale | 268 |
| KOCHER Spatules à goitre | 378 |
| KOENIG Sondes conductrices..... | 377 |
| KOERTE-LUER Curettes pour calculs biliaires..... | 417 |
| KOERTE Ecarteurs | 236 |
| KOFLER-HAJEK Pincés emporte-pièces à laminectomie | 708 |
| KOGAN Endospéculum | 443 |
| KOGAN Spéculum pour urètre et col utérin | 448 |
| KOGLER-CRAIG Set pour la biopsie vertébrale | 720-721 |
| KÖLN MOD. Agrafes hémostatiques pour cuir chevelu | 691 |
| KÖNIG-ROSER Ouvre-bouches | 22 |
| KÖNIG Rugine-raspatoire | 582 |
| KONRICH Boîtes rondes pour stérilisation | 743 |
| KOOS Couteaux pour vaisseaux | 695 |
| KRAUS Couteau pour vaisseaux..... | 695 |
| KRAUSE Trocart pour la ponction du sinus maxillaire | 319 |
| KRAYENBÜHL Crochets à nerfs et à vaisseaux | 215 |
| KRISCHNER Sonde conductrice | 377 |
| KRISTELLER Jeux de spéculum et valves vaginaux | 434-437 |
| KRISTELLER Spéculum vaginaux | 434-437 |
| KRISTELLER Valves vaginales | 434-437 |
| KROENLEIN Pince hémostatique | 173 |
| KRONECKER Aiguilles à ligatures..... | 374 |
| KÜHNE Pince porte-laminaires | 152 |
| KUTZ-KLEINERT Pince passe-tendons..... | 649 |

L

| | |
|--|--------------|
| LA GRANGE Ciseaux pour gencive..... | 94 |
| LABORDE Dilatateur pour la trachéotomie | 728 |
| LAHEY-SWEET Pincés à disséquer et à ligatures | 189 |
| LAHEY Ecarteur | 219 |
| LAHEY Ecarteur à goitre | 224 |
| LAHEY Pince pour abaissement du col de l'utérus..... | 454 |
| LAHEY Pincés à disséquer et à ligatures..... | 189 |
| Lambeaux antérieur, Pince pour saisir | 423 |
| LAMBERT-KAY ATRAUMATIC-GRIP Pincés-clamps pour anastomose de l'aorte avec denture DE BAKEY..... | 549 |
| LAMBERT-LOWMAN Davier..... | 630 |
| LAMBOTE-MINI Ostéotomes..... | 608 |
| LAMBOTE Ostéotomes..... | 608 |
| LAMBOTTE-FARABEUF Davier | 626 |
| LAMBOTTE Daviers..... | 626-627 |
| LAMBOTTE Rugines à costales | 497 |
| Lame de rechange pour scie oscillante | 681 |
| Lame de rechange seule pour dermatome de HUMBLY..... | 42 |
| Lame de rechange seule pour dermatome de SCHINK | 41 |
| Lames | 36 |
| Lames-ciseaux-burins interchangeables..... | 611 |
| Lames-gouges interchangeables | 611 |
| Lames-ostéotomes interchangeables | 611 |
| Lames de bistouris, stériles..... | 34-35 |
| Lames de rasoir..... | 36 |
| Laminectomie, Ecarteurs..... | 276, 279-280 |

| | |
|--|--------------|
| Laminectomie, Pincés emporte-pièces | 707-719 |
| Lampe de rechange (halogène) pour spatules de laryngoscopie | 27, 31 |
| Lampe de rechange pour bandeau frontal de CLAR..... | 11 |
| Lampe de rechange pour bandeau frontal de JANSEN | 11 |
| Lampes de rechange pour spatules de laryngoscopie de MC INTOSH | 25, 27, 29 |
| LANDAU-COLLIN Spéculum vaginaux | 431 |
| LANDAU Spéculum vaginaux | 440 |
| LANDOLT-CUSHING Spécula pour la hypophysectomie | 692 |
| LANDOLT Rugine-raspatoire | 585 |
| LANE-KERN Davier | 625 |
| LANE-MURPHY Levier pour luxation..... | 581 |
| LANE Davier | 625 |
| LANE Pincés à compresses | 201 |
| LANGE-HOHMANN Leviers à os..... | 577 |
| LANGE Ciseaux à pansements | 672 |
| LANGENBECK-KOCHER Ecarteurs | 240 |
| LANGENBECK-MINI Ecarteurs | 224 |
| LANGENBECK-PARKER US-ARMY Ecarteurs | 231 |
| LANGENBECK-RYDER TITE GRIP Porte-aiguilles | 350 |
| LANGENBECK Couteaux à résection | 38 |
| LANGENBECK Davier | 624 |
| LANGENBECK Ecarteurs..... | 238-239 |
| LANGENBECK Elévateurs | 575 |
| LANGENBECK Rugines-raspatoires | 587 |
| LANGENBECK Scie à amputation et résection | 572 |
| LANGENBECK TITE GRIP Porte-aiguilles..... | 350 |
| Laryngoscopes | 24-31 |
| Laryngoscopes lumière froide | 26, 30 |
| Laser, Instruments pour la chirurgie | 448-451 |
| LATHBURY (FARRELL) Porte-cotons | 316 |
| LAWRENCE Pincés à disséquer et à ligatures..... | 187 |
| LAWTON-MATHIEU TITE GRIP Porte-aiguilles | 349 |
| LAWTON TITE GRIP Porte-aiguilles | 349 |
| LAZAR Micro-pincés à ligatures | 121 |
| LEBSCHKE Cisaille et ciseaux-burins à sternum | 492 |
| LEES ATRAUMATIC-GRIP Pincés-clamps à bronches avec denture DE BAKEY | 552 |
| LEGUEU Spatule vésicale | 268 |
| LEKSELL-STILLE Pincés-gouges | 635 |
| LELAND-JONES Pincés-clamps vasculaires périphériques | 534 |
| LEMMON Spatules pour la tunique interne | 512 |
| LEMPERT Curettes | 604 |
| LEMPERT Pincés-gouges | 631-632 |
| LEMPERT Rugines-raspatoires | 584 |
| Lentilles supplémentaires | 9 |
| LERICHE Pincés hémostatiques fines | 165 |
| Levier à tête utilisé en cas de césarienne | 481 |
| Levier obstétrique | 481, 486 |
| Leviers à os | 576-581 |
| Leviers pour luxation | 581 |
| LEWIN Pince à réduction..... | 622 |
| LEWIS Râpes | 592 |
| LEXER-BABY Ciseaux à dissection | 87 |
| LEXER-MAYO Ciseaux à Dissection | 87 |
| LEXER-MAYO Ciseaux à dissection DURACUT | 48 |
| LEXER-MINI Gouges | 612 |
| LEXER-MINI Ostéotomes | 612 |
| LEXER Ciseaux-burins spongieuse | 615 |
| LEXER Ciseaux à dissection | 87 |
| LEXER Ciseaux à dissection DURACUT | 49 |
| LEXER Gouges | 612-613 |
| LEXER Ostéotomes | 612-613 |
| LEYLA Articulation sphérique pour fixation du bras | 705 |
| LEYLA Base de fixation..... | 703 |
| LEYLA Bras de fixation à l'articulation sphérique | 705 |
| LEYLA Bras flexible pour fixation aux têtes d'accouplement | 703 |
| LEYLA Ecarteurs autofixant au crâne | 702, 704 |
| LEYLA Ecarteurs autofixants, Accessoires..... | 703, 705 |
| LEYLA Ecarteurs du cerveau autofixants | 704 |
| LEYLA Supports pour spatules | 703 |
| LEYLA Tête d'accouplement | 705 |
| LICHTENBERG TITE GRIP Porte-aiguilles | 349 |
| LICHTWITZ Trocarts pour la ponction du sinus maxillaire | 319-320 |
| LICHTWITZ VEICKEN Trocarts pour ponction du sinus maxillaire..... | 319 |
| Ligaments, Ciseaux DURACUT | 60 |
| Ligateurs aspirateurs pour hémorroïdes | 411 |
| Ligateurs hémorroïdaux | 410 |
| Ligatures et dissection, Pincés | 180-189, 564 |

| | |
|---|--------------|
| Ligatures et dissection, Pincés avec denture DE BAKEY | 551 |
| Ligatures et thoracique, Pince | 564 |
| Ligatures, Aiguilles | 374-376 |
| Ligatures, Ciseaux | 352-353 |
| Ligatures, Micro-pincés | 121-123 |
| Ligatures, Micro-pincés en titane | 123 |
| Ligatures, Pince | 152 |
| Ligatures, Pincés TITE GRIP | 113 |
| Limes à ongles | 18 |
| Limes à os | 592, 594-595 |
| Limes, Coupés | 595 |
| LINDORF TITE GRIP Pince serre-fils | 662 |
| Liquide concentré pour entretien des instruments PREP LUBE | 733 |
| LISTER Cisailles à pansements et étoffés d'habillement | 674 |
| LISTER Ciseaux à pansements | 673 |
| LISTER Pincés à pansements et tampons | 204 |
| LISTON-KEY-HORSLEY Pince coupante à os | 494 |
| LISTON-LITTAUER Pince coupante | 637 |
| LISTON-RUSKIN Pincés coupantes | 638 |
| LISTON-WALTON (BÖHLER) Pincés coupantes | 638 |
| LISTON Couteau à amputation | 38 |
| LISTON Pincés coupantes | 637, 639 |
| Lit, Bassins | 750 |
| LITTAUER-LISTON Pince coupante | 637 |
| LITTAUER Ciseaux à ligatures | 352 |
| LITTAUER Pince à épiler | 152 |
| LITTER Ciseaux à dissection avec chas | 81 |
| Lobectomie et rectum, Ciseaux | 99 |
| LOCKHART-MUMMERY Sondés pour fistules | 314 |
| LOCKLIN Ciseaux pour gencive | 94 |
| LOCKLIN Ciseaux pour gencive DURACUT | 55 |
| LOCKWOOD Pince à préhension de l'intestin | 386 |
| LONG Pince à hystérectomie | 194 |
| LORNA Pincés pour champs en papier | 202 |
| LOTH-KLINGENBERGH Ciseaux à dissection | 98 |
| LOTH-SCHOEMAKER Ciseaux à ligatures | 352 |
| Loupe seule | 9 |
| Loupes binoculaires | 8 |
| Loupes binoculaires frontales | 8-9 |
| LOUTE Serre-fil | 660 |
| LOVE-GRUENWALD Pincés empore-pièces à laminectomie | 716 |
| LOVE-KERRISON (COLCLOUGH) Pincés emporte-pièces à laminectomie | 710-711 |
| LOVE Rétracteurs pour racines nerveuses | 701 |
| LOVELACE-DIXON Pincés hémostatiques fines | 169 |
| LOVELACE Pince à préhension de l'intestin | 387 |
| LOWER Pincés à disséquer et à ligatures | 189 |
| LOWMAN-HOGLUND Davier | 630 |
| LOWMAN-LAMBERT Davier | 630 |
| LOWMAN Daviers | 630 |
| LUCAE Crochets à nerfs et à vaisseaux | 213 |
| LUCAE Diapason pour neurologie | 4 |
| LUCAE Maillet | 617 |
| LUCAE Pince auriculaire et nasale | 136 |
| LUCAS Curettes | 599 |
| LUER-FRIEDMAN Pince-gouge | 631 |
| LUER-KOERTE Curettes pour calculs biliaires | 417 |
| LUER-STILLE Pincés-gouges | 634, 636 |
| LUER Canules pour la trachéotomie | 725 |
| LUER Ecarteur double | 227 |
| LUER Pincés-gouges | 631-632 |
| LUIKART-KIELAND Forceps | 479 |
| Lunettes | 9 |
| Lunettes à loupes binoculaires | 9 |
| Luxation, Leviers | 581 |

M

| | |
|--|---------|
| MAGILL Pincés pour intubation | 32 |
| MAIER-SIMS Pincés à pansements et tampons | 205 |
| MAIER Pincés à pansements et tampons | 205 |
| Maillets | 617-618 |
| Maillets avec manche en „Ferrozell“ | 619 |
| Main de plomb | 644 |
| Main, Perforateur | 651-653 |
| Mains, Ecarteurs | 271 |
| MALTZ Râpe | 593 |
| MALTZ TITE-GRIP Râpes | 596 |

| | |
|--|--------|
| Manche à billes | 721 |
| Manche pour lames interchangeables | 611 |
| Manches démontables | 571 |
| Manches en métal pour miroirs laryngiens | 13 |
| Manches pour bistouris | 34-35 |
| Manches réversibles | 571 |
| Mandrin pour sondés | 425 |
| Mandrin pour sondés en gomme | 425 |
| MARBACH Ciseaux à épisiotomie | 107 |
| MARBERGER (GIL-VERNET) Ecarteurs à veines et à hile rénal | 223 |
| MARKWALDER Pince coupante pour la base des côtes | 494 |
| MARQUARDT Pince-gouge | 634 |
| Marteaux | 2-3 |
| MARTIN Curettes | 598 |
| MARTIN Ecarteur pour interventions en profondeur | 254 |
| MARTIN Pelvimètre | 477 |
| MARTIN Pincés à ménisque et cartilage | 640 |
| MASSON-JUDD Ecarteur vésical | 310 |
| MASSON Porte-aiguilles | 368 |
| MASSON TITE GRIP Porte-aiguilles | 347 |
| MASTIN Pince-clamp musculaire | 728 |
| MATHIEU-LAWTON TITE GRIP Porte-aiguilles | 349 |
| MATHIEU Ecarteurs | 231 |
| MATHIEU Ecarteurs doubles | 226 |
| MATHIEU Porte-aiguilles | 371 |
| MATHIEU Spéculum rectal | 405 |
| MATHIEU Spéculums vaginaux | 439 |
| MATHIEU TITE GRIP Porte-aiguilles | 349 |
| MATHIEU Valves vaginaux | 439 |
| MATSON Rugine à costales | 497 |
| MATZENAUER Spéculums vaginaux | 440 |
| MAUNDER Baillon en bois | 22 |
| MAYFIELD Pince-gouge | 633 |
| MAYO-ADAMS Ecarteurs pour appendicectomie | 284 |
| MAYO-BLAKE Pincés pour calculs biliaires | 418 |
| MAYO-HARRINGTON Ciseaux à dissection | 86 |
| MAYO-HEGAR Porte-aiguilles | 367 |
| MAYO-HEGAR TITE GRIP Porte-aiguilles | 345 |
| MAYO-HEGAR TITE GRIP Porte-aiguilles pour gauchers | 341 |
| MAYO-LEXER Ciseaux à dissection DURACUT | 48 |
| MAYO-LEXER Ciseaux à dissection | 87 |
| MAYO-NOBLE Ciseaux à dissection | 86 |
| MAYO-ROBSON ATRAUMATIC-GRIP Pincés-clamps intestinales | 396 |
| MAYO-ROBSON Pincés-clamps intestinales | 396 |
| MAYO-STILLE Ciseaux à dissection | 85 |
| MAYO-STILLE Ciseaux à dissection DURACUT | 48 |
| MAYO Abaisse-langue | 12 |
| MAYO Ciseaux à dissection | 84 |
| MAYO Ciseaux à dissection DURACUT | 47 |
| MAYO Curette pour calculs biliaires | 417 |
| MAYO Ecarteur intra-abdominaux | 249 |
| MAYO Epingles à instruments | 736 |
| MAYO Pince pour vaisseaux et tumeurs | 149 |
| MC DONALD Dissecteur | 574 |
| MC GIVNEY Pince-clamp pour hémorroïdes | 410 |
| MC INDOE Ciseaux pour cartilage | 82 |
| MC INDOE Pince coupante | 638 |
| MC INDOE Pince fine à dissection | 130 |
| MC INDOE TITE GRIP Pince à dissection | 113 |
| MC INTOSH Laryngoscopes | 24-27 |
| MC INTOSH Laryngoscopes lumière froide | 26 |
| MC INTOSH Spatules de laryngoscopie | 25, 27 |
| MC INTOSH Spatules de laryngoscopie avec lumière froide | 27 |
| MC INTOSH Troussés à laryngoscopie | 24, 28 |
| MC INTOSH Troussés à laryngoscopie lumière froide | 26 |
| MC KENTY Rugine-raspatoire | 582 |
| MC KENZIE Agrafes en argent | 690 |
| MC KENZIE Fil d'argent pour fabriquer des agrafes | 690 |
| MC KENZIE Fraise | 652 |
| MC KENZIE Pince pose clips | 690 |
| MC KENZIE Support porte-agraves | 690 |
| MC PHERSON Micro-pincés à ligatures | 122 |
| MEAD Maillet | 618 |
| MEAD Pincés-gouges | 631 |
| Méatotome | 426 |
| Médicaments, Cuillère | 751 |
| MEEKER-BABY Pincés à disséquer et à ligatures | 180 |
| MEEKER Pincés à disséquer et à ligatures | 187 |
| MENGHINI Aiguille pour la ponction aveugle du foie | 329 |

| | |
|--|-----------|
| MENGHINI Aiguille pour la ponction contrôlée du foie | 329 |
| Ménisque et cartilage, Pincés | 640 |
| Ménisque, Bistouris | 642-643 |
| MERCEDES Ecarteur thoracique | 507 |
| METZENBAUM-BABY Ciseaux à dissection | 89 |
| METZENBAUM-NELSON Ciseaux à dissection | 91 |
| METZENBAUM-NELSON Ciseaux à dissection modèles fins DURACUT | 53 |
| METZENBAUM-NELSON Ciseaux à dissection modèles standard DURACUT | 53 |
| METZENBAUM-THOREK Ciseaux adnex DURACUT | 54 |
| METZENBAUM Ciseaux à dissection | 88-90 |
| METZENBAUM Ciseaux à dissection DURACUT | 49 |
| METZENBAUM Ciseaux à dissection modèles fins | 90 |
| METZENBAUM Ciseaux à dissection modèles standard | 90 |
| METZENBAUM Ciseaux à dissection modèles standard DURACUT | 50-52, 54 |
| MEYERDING Ecarteurs | 225 |
| MEYERDING Ecarteurs pour appendicéctomie | 284 |
| MICHEL Agrafes | 379 |
| MICHEL Miroirs pour rhinoscopie | 14 |
| MICHEL Pince à poser et à retirer les agrafes | 379 |
| MICHEL Pince à poser les agrafes | 379 |
| MICRO-ADSON Pincés fines à dissection | 129 |
| MICRO-ADSON Pincés fines chirurgicales | 140-141 |
| MICRO-ADSON TITE GRIP Pincés à dissection à griffes | 117 |
| MICRO-CASTROVIEJO Micro-Porte-aiguilles | 358 |
| Micro-chirurgie, Boîte ronde pour instruments | 737 |
| Micro-ciseaux | 62-67 |
| Micro-ciseaux à disséquer | 65 |
| MICRO-CRILE Pincés hémostatiques fines | 166 |
| MICRO-HALSTED Pincés hémostatiques fines | 164 |
| Micro-pincés | 125 |
| Micro-pincés (modèles horloger) | 120 |
| Micro-pincés à ligatures | 121-123 |
| Micro-pincés à ligatures en titane | 123 |
| Micro-pincés en titane pour saisir les tissus | 124 |
| Micro-pincés pour saisir les tissus | 124 |
| Micro-Pincés TITE GRIP | 118 |
| Micro-Porte-aiguilles | 358-362 |
| Micro-Porte-aiguilles en TITANE | 362 |
| Micro-Porte-aiguilles TITE GRIP | 338-339 |
| Micro Clamps Bulldog | 162 |
| Micro lames | 473 |
| Microchirurgie, Crochets | 212 |
| Microchirurgie, Instruments | 694-697 |
| Microscopie, Pincés | 121 |
| MIDDELDOFF Ecarteurs | 243 |
| MIKULICZ-BABY Pincés-clamps pour péritoine | 192 |
| MIKULICZ Ecarteurs pour interventions en profondeur | 255 |
| MIKULICZ Pincés-clamps pour péritoine | 192-193 |
| MILAN Curettes pour biopsie endo-cervicale | 460 |
| MILLER-SENN Ecarteurs doubles | 226 |
| MILLER Laryngoscopes | 28, 30-31 |
| MILLER Râpes | 592 |
| MILLER Spatules de laryngoscopie | 29, 31 |
| MILLER Spatules de laryngoscopie avec lumière froide | 31 |
| MILLER TITE-GRIP Râpes | 596 |
| MILLER Trousse à laryngoscopie avec lumière froide | 30 |
| MILLER Trousses à laryngoscopie | 28, 30 |
| MILLES Micro-ciseaux | 64 |
| MILLIGAN Dissecteur pour la dure-mère | 698 |
| MILLIN-YOUNG Porte-aiguilles boomerangs | 372 |
| MILLIN Dilatateur vésicale | 423 |
| MILLIN Ecarteurs vésicaux | 310 |
| MILLIN Pince porte-fil | 423 |
| MILLIN Pince pour saisir les capsules | 423 |
| MILLIN Pince pour saisir les lambeaux antérieurs | 423 |
| MINI-HOHMANN Leviers à os | 576 |
| MINI-KERN Davier | 625 |
| MINI-LAMBOTTE Ostéotomes | 608 |
| MINI-LANGENBECK Ecarteurs | 224 |
| MINI-LEXER Gouges | 612 |
| MINI-LEXER Ostéotomes | 612 |
| MINI-STILLE Cisailles pour appareils plâtrés | 677 |
| MINI-YASARGIL Applicateurs pour clips vasculaires | 154 |
| MINI-YASARGIL Serre-Fines | 154 |
| MIOTTI-OVERHOLT Pincés à disséquer et à ligatures | 185 |
| Miroir frontal seul | 10 |
| Miroirs | 10 |

| | |
|--|--------------|
| Miroirs frontaux | 10 |
| Miroirs laryngiens avec manche fixe | 14 |
| Miroirs laryngiens sans manche | 13 |
| Miroirs pour rhinoscopie | 14 |
| MIXTER-BABY Pincés à disséquer et à ligatures | 180 |
| MIXTER-GEMINI Pincés à disséquer et à ligatures | 181 |
| MIXTER-O'SHAUGNESSY Pincés à disséquer et à ligatures | 182 |
| MIXTER-OVERHOLT Pincés à disséquer et à ligatures | 183 |
| MIXTER-PAUL (HEISS) Pincés à disséquer et à ligatures | 182 |
| MIXTER Ciseaux à chirurgie | 79 |
| MIXTER Pince pour calculs biliaires | 419 |
| MIXTER Pincés à disséquer et à ligatures | 182, 188-189 |
| MOBERG Ecarteurs | 224 |
| MOD. ENGL. Pincés à compresses | 200 |
| MOD. KÖLN Agrafes hémostatiques pour cuir chevelu | 691 |
| MOD. MÜNCHEN Curette pour biopsie | 459 |
| MOD. SWITZERLAND Micro-pincés (modèles horloger) | 120 |
| MOD. USA Ciseaux pour le cordon ombilical | 108 |
| MOD. USA Curettes | 601 |
| MOD. USA Pince écartantes à plâtre | 682 |
| MOD. USA Pincés à dissection modèles étroits | 133 |
| MOD. USA Pincés à dissection modèles standard | 133 |
| MODELL CANAD. Bistouris à ménisque | 643 |
| MODELL RUSS. Pincés pour vaisseaux et tumeurs | 149 |
| MOGEN Instrument de circoncision | 426 |
| MOLDESTAD Ecarteur à veines | 217 |
| MÖLTGEN Goniomètre pour les membres | 7 |
| MOORE-STAUDE Pince pour abaissement du col de l'utérus | 452 |
| MOORE Cuillère pour vésicule biliaire | 417 |
| MORGAN-TISCHLER Pince emporte-pièces à biopsie | 464 |
| MORRIS-DE BAKEY ATRAUMATIC-GRIP Pincés-clamps pour aorte | 540 |
| MORSE Ecarteur à sternotomie | 499 |
| MOSQUITO-BABY (HARTMANN) Pincés hémostatiques fines | 164 |
| MOSQUITO-HALSTED-DE BAKEY Pincés hémostatiques fines | 165 |
| MOSQUITO-HALSTED HEISS Pincés hémostatiques fines | 170 |
| MOSQUITO-HALSTED Pincés hémostatiques fines | 164-165 |
| MOTT-PARKER Ecarteurs doubles | 228 |
| MOYNIHAN Pincés hémostatiques | 178 |
| MOYNIHAN Sonde-curette pour vésicule biliaire | 415 |
| MÜHLING (KILLIAN) Ciseaux pour cloison des fosses nasales | 102 |
| MÜHLING Rugines-raspatoires | 584 |
| MÜLLER-BIEMER Approximateurs | 157 |
| MÜLLER-VERBRUGGE Leviers à os | 579 |
| MÜLLER Approximateurs | 158 |
| MUMMERY-LOCKHART Sondes pour fustules | 314 |
| MÜNCHEN MOD. Curette pour biopsie | 459 |
| MURLESS Levier à tête utilisé en cas de césarienne | 481 |
| MURPHY-LANE Levier pour luxation | 581 |
| MURPHY Bandeau frontal en celluloid blanc | 10 |
| MURRAY-CRILE Porte-aiguilles | 366 |
| Musculaire, Pince-clamp | 728 |
| MUSEUX Pincés pour abaissement du col de l'utérus | 456 |
| MYERS Strippers à varices | 315 |

N

| | |
|--|---------|
| NABATOFF Strippers à varices | 315 |
| NAEGELE Forceps | 478 |
| NAGEL Micro-ciseaux | 67 |
| Nasales et auriculaires, Pincés | 136-137 |
| Nasaux, Ciseaux | 101-102 |
| Nasaux, Ciseaux DURACUT | 58 |
| Nasaux, Crochets | 221 |
| NEALTON Sonde boutonnée cannelée | 314 |
| Nécessaire à suture | 380 |
| NEFF Bistouris à ménisque | 642 |
| NEGUS Pincés hémostatiques et pour amygdales | 179 |
| NEIVERT-COTTLE Crochet nasal | 221 |
| NEIVERT Porte-aiguilles | 363 |
| NEIVERT TITE GRIP Porte-aiguilles | 342 |
| NELSON-METZENBAUM Ciseaux à dissection | 91 |
| NELSON-METZENBAUM Ciseaux à dissection modèles fins DURACUT | 53 |
| NELSON-METZENBAUM Ciseaux à dissection modèles standard DURACUT | 53 |
| NELSON Pince chirurgicale | 148 |
| NELSON Trocart | 318 |
| Nerf trigéminal, Ciseaux | 100 |
| Nerfs et vaisseaux, Crochets | 213-215 |

| | |
|--|-----|
| Nerfs, Ciseaux à dissection | 93 |
| Neuro-chirurgie, Ciseaux | 100 |
| NEW ORLEANS Porte-aiguilles | 367 |
| NEW ORLEANS TITE-GRIP Porte-aiguilles | 344 |
| NEWS Ecarteur pour trachéotomie | 217 |
| NOBLE-MAYO Ciseaux à dissection | 86 |
| NORTHBENT SPENCER Ciseaux à ligatures | 352 |
| NOTO Pince à polypes et ovaires | 457 |
| NOTT Spéculum vaginaux | 433 |
| NOVAK Curette pour biopsie | 459 |

O

| | |
|--|--------------|
| O'BRIEN Ciseaux à ligatures | 352 |
| Obstétrique, Instruments | 481 |
| Obstétrique, Levier | 481, 486 |
| Obturbateur mou pour pousser les échantillons de tissu | 721 |
| OBWEGESER Ecarteurs | 241 |
| OBWEGESER TITE-GRIP Pincés à ligatures | 113 |
| Occlusion tangentielle, vasculaires, Pincés ATRAUMATIC-GRIP | 541 |
| Occlusion tangentielle, pincés-clamps | 562 |
| Occlusion, Pincés-clamps ATRAUMATIC-GRIP | 398-399 |
| OCHSNER-ALLIS Pince à préhension de l'intestin | 383 |
| OCHSNER-DIXON CRILE-RANKIN Pincés hémostatiques fines | 167 |
| OCHSNER-KOCHER Pincés hémostatiques | 177 |
| OCHSNER-ROCHESTER Pincés hémostatiques | 178 |
| OCHSNER ATRAUMATIC-GRIP Pince-clamp pour aorte avec denture DE BAKEY | 539 |
| OCHSNER Dilatateur à voies biliaires | 415 |
| OCHSNER Pince pour ligatures | 152 |
| OCHSNER trocarts | 318 |
| O'CONNOR-O'SULLIVAN Ecarteur abdominal | 304 |
| O'CONNOR Crochet à peau | 217 |
| OEHLER TITE GRIP Pincés | 118 |
| Og, Aiguilles pour ophtalmologie | 354 |
| OLDBERG Pince pour l'hypophyse | 719 |
| OLIVECRONA-TOENNIS (SCOVILLE) Pince pose clips | 690 |
| OLIVECRONA (GIGLI) Fils-scies | 687 |
| OLIVECRONA Ciseaux pour le nerf trigéminal | 100 |
| OLIVECRONA Dissecteurs pour la dure-mère | 700 |
| OLIVECRONA Spatules cérébrales | 706 |
| OLLIER Ecarteurs | 236 |
| OLSEN-HEGAR-BABY TITE GRIP Porte-aiguilles | 348 |
| OLSEN-HEGAR Porte-aiguilles avec ciseaux | 370 |
| OLSEN-HEGAR TITE GRIP Porte-aiguilles | 348 |
| OMBREDANNE Maillet | 621 |
| Ongles, Ciseaux à fendre | 81 |
| Ongles, Instruments | 645 |
| Ongles, Perceuse | 645 |
| Ongles, Pince | 645 |
| Ongles, Pince pour extraction | 645 |
| Opération, Ciseaux | 80 |
| Ophtalmologie, Aiguilles | 354 |
| Os, Daviers | 493 |
| Os, Ecarteurs | 232 |
| Os, Leviers | 576-581 |
| Os, Limes | 592, 594-595 |
| Os, Pincés coupantes | 494 |
| Os, Ponction, Tréphine | 721 |
| O'SHAUGNESSY-MIXTER Pincés à disséquer et à ligatures | 182 |
| Osseuse biopsie, Instruments | 669 |
| Ostéotomes | 607-610, 612 |
| Ostéotomes et gouges avec manche en „Ferrozell“ | 612 |
| Ostéotomes, ciseaux-burins et gouges avec manche en „Ferrozell“ | 611-613 |
| O'SULLIVAN-O'CONNOR Ecarteur abdominal | 304 |
| Ouvre-bouches | 22 |
| Ovaires et polypes, Pincés | 457 |
| OVERHOLT-BABY Pincés à disséquer et à ligatures | 183 |
| OVERHOLT-GEISSENDOERFER Pincés à disséquer et à ligatures | 184 |
| OVERHOLT-MIOTTI Pincés à disséquer et à ligatures | 185 |
| OVERHOLT-MIXTER Pincés à disséquer et à ligatures | 183 |
| OVERHOLT Pincés à disséquer et à ligatures | 183, 185 |

P

| | |
|--|-----|
| PACIFIC-KEVOURKIAN Pince emporte-pièces à biopsie | 464 |
| Paniers de stérilisation | 745 |

| | |
|--|---------|
| Paniers pour brosses et pour essuie-mains | 753 |
| Pansements et étoffes d'habillement, Cisailles | 674 |
| Pansements et tampons, Pincés | 204-207 |
| Pansements, Ciseaux | 672-673 |
| Pansements, Pincés | 208 |
| Papier, Pincés à champs | 202 |
| PARK-ALAN Ecarteur rectal | 408 |
| PARKER-LANGENBECK US-ARMY Ecarteurs | 231 |
| PARKER-MOTT Ecarteurs doubles | 228 |
| PARKER Ecarteurs doubles | 228 |
| PASQUE EUFRATE TITE GRIP Porte-aiguilles | 344 |
| Passe-fils | 697 |
| Passe-fils, Aiguilles | 660-661 |
| Patella, Pince | 623 |
| Patent-ductus, Clamps avec denture DE BAKEY ATRAUMATIC-GRIP | 531 |
| PAUFIQUE Pince fine chirurgicale | 139 |
| PAUL-MIXTER (HEISS) Pincés à disséquer et à ligatures | 182 |
| PAUL Ecarteur à gaines tendineuses | 225 |
| PAYR-BABY Pince-clamp et écraseur pour l'intestin et l'estomac | 403 |
| PAYR Aiguilles vasculaires | 354 |
| PAYR Pincés-clamps et écraseur pour l'intestin et l'estomac | 403 |
| PAYR Sondes conductrices | 377 |
| Pb Aiguilles intestinales | 354 |
| PEAN-DE BAKEY ATRAUMATIC-GRIP Pincés vasculaires | 529 |
| PEAN-DE BAKEY Pincés hémostatiques | 176 |
| PEAN-ROCHESTER Pincés hémostatiques | 175 |
| PEAN Pincés hémostatiques | 173-174 |
| Peau et tissus, Crochet double pour saisir et soulever | 212 |
| Peau, Crochets | 216-217 |
| PEDERSON Spéculum vaginaux | 432-433 |
| Pédicules rénaux, Pincés-clamps | 191 |
| PEERS Pince pour champs en papier | 202 |
| PEET Pincés à échardes | 151 |
| PELTESON Porte-cotons | 317 |
| Pelvimètre | 477 |
| PENFIELD Dissecteur pour la dure-mère | 699 |
| PENNINGTON Pincés à préhension de l'intestin | 387 |
| Perce-crâne | 485 |
| Perce membrane, Pince | 477 |
| Perceuse à ongles | 645 |
| PERCY Manches démontables | 571 |
| PERCY Manches reversibles | 571 |
| Perforateur | 652 |
| Perforateur à main | 651-653 |
| Périnée (épisiotomie), Ciseaux | 107 |
| Périphérique, Pince-clamp | 558 |
| Périphériques, vasculaires, Pincés-clamps | 534 |
| Périphériques, vasculaires, Pincés-clamps avec denture DE BAKEY ATRAUMATIC-GRIP | 535-536 |
| Péritoine, Pincés-clamps | 192-193 |
| PERMAN Ecarteur abdominal | 299 |
| PERTHES Pointes-carrées | 650 |
| PHANEUF Pincés à hystérectomie | 194 |
| Pièces de raccord | 333 |
| Pièces de rechange pour BERGER loupes binoculaires | 8 |
| Pièces de rechange pour éclairer frontal de CLAR | 11 |
| Pièces de rechange pour loupes binoculaires | 9 |
| Pied à coulisse | 7 |
| PIERCE Trocart pour la ponction du sinus maxillaire | 319 |
| PIFFARD Curettes pour les lupus | 20 |
| PINARD Stéthoscopes en aluminium | 5 |
| Pince-clamp à pression | 409 |
| Pince-clamp périphérique | 558 |
| Pince-clamp pour anévrisme de l'aorte | 561 |
| Pince-clamp pour aorte | 561 |
| Pince-clamp pour la carotide | 537 |
| Pince-clamp utérine pour hémostase | 481 |
| Pince-guide et pour protéger la dure-mère | 650 |
| Pince à ligatures TITE GRIP | 113 |
| Pince à ongles | 645 |
| Pince à poser et à retirer les agrafes | 379 |
| Pince à préhension de l'intestin ATRAUMATIC-GRIP | 389 |
| Pince conductrice pour cathéters et tubes | 473 |
| Pince crânienne | 688 |
| Pince emporte-pièces à biopsie | 460-465 |
| Pince hémostatique rénale | 537 |
| Pince patella | 623 |
| Pince perce membrane | 477 |
| Pince porte-fil | 423 |

| | | | |
|--|-------------------|--|---------|
| Pince porte-laminaires | 152 | Pincettes pour saisir et casser les lames de rasoir | 36 |
| Pince pose clips | 690 | PIPER Forceps | 480 |
| Pince pour changer les valves | 289 | Pipette en verre | 473 |
| Pince pour extraction des ongles | 645 | Pistolet-laveur à jet d'eau avec plusieurs embouts | 754 |
| Pince pour fixer le cordon | 425 | Pistolet-laveur à jet d'eau, Embouts | 755 |
| Pince pour la préhension du rein | 421 | Placenta et avortement, Curettes | 484 |
| Pince pour le cuir chevelu | 481 | Placentaires et pour poste-abortum, Pincettes | 482-483 |
| Pince pour ligatures | 152 | Plaies, Crochets | 218 |
| Pince pour poser et retirer les clamps Bulldog | 527 | Plaque pour tendre la peau seule pour dermatome de SCHINK | 41 |
| Pince pour poser et retirer les clips hémostatiques du cuir chevelu | 691 | Plateaux de stérilisation | 744 |
| Pince pour poser et retirer les clamps Bulldog TITAN-LINE | 160 | Plateaux pour instruments | 748 |
| Pince pour saisir les capsules | 423 | Plâtre, Pincettes écartantes | 682 |
| Pince pour saisir les lambeaux antérieurs | 423 | Plâtre, Scie oscillante | 680 |
| Pince pour tunnelisateur | 517 | PLESTER Ecarteurs autostatiques | 275 |
| Pince thoracique et pour ligatures | 564 | Plomb, Main | 644 |
| Pince/couvercle, Combinaison | 735 | Pneumopéritoine, Aiguilles | 329 |
| Pince-clamp musculaire | 728 | | |
| Pince à déchets | 735 | | |
| Pincettes | 668 | | |
| Pincettes-clamps à anastomose (veine cave) | 565 | | |
| Pincettes-clamps à anastomose avec denture COOLEY | 559, 560 | | |
| Pincettes-clamps à anastomose avec denture DE BAKEY | 542-544 | | |
| Pincettes-clamps à anastomose du rectum | 400 | | |
| Pincettes-clamps à anastomose du rectum ATRAUMATIC-GRIP | 401 | | |
| Pincettes-clamps à bronches | 566 | | |
| Pincettes-clamps à bronches ATRAUMATIC-GRIP | 552 | | |
| Pincettes-clamps à occlusion ATRAUMATIC-GRIP | 398-399 | | |
| Pincettes-clamps auriculaires | 564 | | |
| Pincettes-clamps iliaques | 558 | | |
| Pincettes-clamps intestinales | 390-394 | | |
| Pincettes-clamps intestinales ATRAUMATIC-GRIP | 391-393, 395-396 | | |
| Pincettes-clamps intestinales et à anastomose | 402 | | |
| Pincettes-clamps pour anastomose | 520-523 | | |
| Pincettes-clamps pour anastomose de l'aorte ATRAUMATIC-GRIP | 548-549 | | |
| Pincettes-clamps pour anévrisme de l'aorte ATRAUMATIC-GRIP | 545-547 | | |
| Pincettes-clamps pour aorte | 537 | | |
| Pincettes-clamps pour aorte ATRAUMATIC-GRIP | 538-540 | | |
| Pincettes-clamps pour coarctation avec denture COOLEY | 557 | | |
| Pincettes-clamps pour coarctation avec denture DE BAKEY | 532-533 | | |
| Pincettes-clamps pour fémorale | 534 | | |
| Pincettes-clamps pour hémorroïdes | 410 | | |
| Pincettes-clamps pour la carotide | 527 | | |
| Pincettes-clamps pour la carotide avec denture LAWTON ATRAUMATIC-GRIP | 524 | | |
| Pincettes-clamps pour l'intestin et l'estomac | 403 | | |
| Pincettes-clamps pour occlusion tangentielle | 562 | | |
| Pincettes-clamps pour pédicules rénaux | 191 | | |
| Pincettes-clamps pour péritoine | 192-193 | | |
| Pincettes-clamps pour veine cave ATRAUMATIC-GRIP | 550 | | |
| Pincettes-clamps stomacales ATRAUMATIC-GRIP | 397 | | |
| Pincettes-clamps universelles | 520-523, 530, 562 | | |
| Pincettes-clamps universelles avec denture DARDIK | 554 | | |
| Pincettes-clamps universelles avec denture DE BAKEY | 553 | | |
| Pincettes-clamps vasculaires périphériques | 534 | | |
| Pincettes-clamps vasculaires périphériques ATRAUMATIC-GRIP | 535-536 | | |
| Pincettes- DIU | 447 | | |
| Pincettes-gouges | 631-636 | | |
| Pincettes-gouges | 494 | | |
| Pincettes-guides | 650 | | |
| Pincettes-micro | 125 | | |
| Pincettes-micro (modèles horloger) | 120 | | |
| Pincettes-micro à ligatures | 121-123 | | |
| Pincettes-micro à ligatures en titane | 123 | | |
| Pincettes-micro en titane pour saisir les tissus | 124 | | |
| Pincettes-micro pour saisir les tissus | 124 | | |
| Pincettes-Micro TITE GRIP | 118 | | |
| Pincettes à affronter | 378 | | |
| Pincettes à biopsie rectale | 412 | | |
| Pincettes à compresses | 200-202 | | |
| Pincettes à couper le fil | 668 | | |
| Pincettes à couper le fil DURACUT | 667 | | |
| Pincettes à dissection | 132-134 | | |
| Pincettes à dissection à griffes TITE GRIP | 117 | | |
| Pincettes à dissection TITE GRIP | 113-115, 117 | | |
| Pincettes à dissection TITE GRIP modèles standard | 115 | | |
| Pincettes à disséquer et à ligatures | 180-189, 564 | | |
| Pincettes à disséquer et à ligatures ATRAUMATIC-GRIP | 551 | | |
| Pincettes à échardes | 150-151 | | |
| Pincettes à envies | 17 | | |

| | |
|---|-------------------|
| Poignées à piles pour spatules de laryngoscopie de MC INTOSH | 25, 27, 29, 31 |
| Poignées pour scies | 687 |
| Pointes-carrées | 650 |
| Polypes et ovaies, Pincés | 457 |
| Ponction lombaire, Aiguilles | 328 |
| Ponction pleurale, Aiguille | 518 |
| Ponction pour os, Tréphine | 721 |
| Ponction pour tissu mou, Tréphine | 721 |
| Ponction sternale, Aiguilles | 518 |
| POOLE Canules d'aspiration | 325 |
| Porte-aiguilles | 358-372 |
| Porte-aiguilles-Micro | 358-362 |
| Porte-aiguilles-Micro en TITANE | 362 |
| Porte-aiguilles-Micro TITE GRIP | 338-339 |
| Porte-aiguilles avec ciseaux | 370 |
| Porte-aiguilles boomerangs | 372 |
| Porte-aiguilles pour gauchers TITE GRIP | 341 |
| Porte-aiguilles TITAN-LINE | 365 |
| Porte-aiguilles TITE GRIP | 340-350 |
| Porte-clamps | 402 |
| Porte-cotons | 316-317, 409, 473 |
| Porte-fil, Pince | 423 |
| Porte-lames | 473 |
| Porte-laminaires, Pince | 152 |
| Porte-ligature | 378 |
| Porte-tampon, Conducteur | 447 |
| Portes instruments | 736 |
| Poste-abortum et placentaires, Pincés | 482-483 |
| POTTS-DE BAKEY Patent-ductus, Clamps ATRAUMATIC-GRIP | 531 |
| POTTS-SMITH Ciseaux à dissection | 98 |
| POTTS-SMITH Ciseaux vasculaires | 96-98 |
| POTTS-SMITH Ciseaux vasculaires DURACUT | 56 |
| POTTS-SMITH Pincés fines à dissection | 131 |
| POTTS-SMITH Pincés fines chirurgicales | 143 |
| POTTS-SMITH TITE GRIP Pincés à dissection | 114 |
| Poumons, Ecarteur | 260 |
| Poumons, Pincés pour dissection | 149 |
| Pousse fil | 378 |
| POZZI Pince pour abaissement du col de l'utérus | 453 |
| PRATT Pincés pour abaissement du col de l'utérus | 455 |
| PRATT Sondes pour fistules | 409 |
| PRATT spéculum rectal | 405-406 |
| Préhension du rein, Pince | 421 |
| Prélèvements des sécrétions, Cuillère | 425 |
| PREP LUBE Liquide concentré pour entretien des instruments | 733 |
| PRESBYTERIAN Pince presse-tubes | 203 |
| Presse-tubes, Pincés | 203 |
| PRICE-THOMAS Pincés-clamps à bronches | 566 |
| Prostatectomie, Instruments | 423 |
| Prostatiques, Ecarteurs | 422 |
| Prothèses dentaires, récipient | 751 |
| PROVIDENCE-HOSPITAL Pincés hémostatiques fines | 168 |
| Pulmonaire, Spatule | 260 |
| Pulmonaires, Ecarteurs et spatules | 261-265 |
| PUTTI Limes à os | 594 |
| Pylore, Ecarteur | 403 |
| PYNCHON-ANDREW Canule d'aspiration | 325 |

Q

| | |
|--|-----|
| QUERVAIN Elévateur | 575 |
| QUINBY Ciseaux pour gencive | 94 |
| QUINKE Aiguilles pour ponction lombaire | 328 |

R

| | |
|--|-----|
| RABINER Marteaux à réflexes | 3 |
| Racines nerveuses, Rétracteurs | 701 |
| RAGNELL-DAVIS Ecarteurs pour la chirurgie plastique | 226 |
| RAGNELL Ciseaux à chirurgie et à dissection | 83 |
| RAGNELL Ciseaux à dissection DURACUT | 49 |
| RAGNELL Ciseaux à dissection et à chirurgie | 83 |
| RALK Perforateur à manivelle | 653 |
| RALKS Pince à échardes | 151 |
| RAMPLEY Pincés à tampons et éponges | 210 |
| RANDALL Curette pour biopsie | 459 |

| | |
|---|----------|
| RANDALL Pincés pour les calculs rénaux | 420-421 |
| RANEY Agrafes hémostatiques pour cuir chevelu | 691 |
| RANEY Pince pour poser et retirer les clips hémostatiques du cuir chevelu | 691 |
| RANEY Support porte-agrales | 691 |
| RANKIN-CRILE-DEBAKEY Pincés hémostatiques fines | 167 |
| RANKIN-CRILE (OCHSNER-DIXON) Pincés hémostatiques fines | 167 |
| RANKIN-CRILE Pincés hémostatiques fines | 167 |
| RANKIN-KELLY Pincés hémostatiques fines | 169 |
| Râpes | 592-595 |
| Râpes TITE GRIP | 596-597 |
| Râpes, Coupes | 595 |
| Rapprocheurs de côtes | 508 |
| Raspatoires-rugines | 582-591 |
| Raspatoires-rugines avec manche en „Ferrozell“ | 590-591 |
| RAY Curettes | 692 |
| RECAMIER Curettes à avortement et placenta | 484 |
| RECAMIER Curettes utérines | 468 |
| Récipient à prothèses dentaires | 751 |
| Récipients | 747 |
| Récipients cylindriques | 747 |
| Rectal, Ecarteur | 408 |
| Rectale, Ciseaux pour chirurgie DURACUT | 59 |
| Rectales, Sondes | 409 |
| Rectaux, Spéculums | 405-406 |
| Rectum et anus, Dilatateurs | 407-408 |
| Rectum et lobectomie, Ciseaux | 99 |
| Rectum, Pincés-clamps à anastomose | 400 |
| Rectum, Pincés-clamps à anastomose ATRAUMATIC-GRIP | 401 |
| REDO Pincés-clamps intestinales | 390 |
| REDON Aiguilles guides | 334 |
| Réduction, Pincés | 622-623 |
| Réflecteur pour bandeaux frontaux de CLAR | 11 |
| Règle | 6 |
| Règle en acier | 6 |
| Règle radiologique | 6 |
| REINER Couteau pour appareils plâtrés | 679 |
| Rénales, Pincés hémostatiques | 537, 558 |
| Rénaux, Clamps | 190 |
| Réniformes, Bassins | 750 |
| RESANO ATRAUMATIC-GRIP Pince-clamp à anastomose du rectum | 401 |
| Réséction et amputation, Scies | 572-573 |
| Retracteurs | 571 |
| Rétracteurs pour racines nerveuses | 701 |
| REVERDIN Aiguilles | 373 |
| REVERDIN Spatules abdominaux et intestinaux | 267 |
| REYNOLDS-COOLEY ATRAUMATIC-GRIP Pincés-clamps à anastomose avec denture COOLEY | 559 |
| REYNOLDS-DE BAKEY ATRAUMATIC-GRIP Pincés-clamps à anastomose avec denture DE BAKEY | 542 |
| REYNOLDS Ciseaux fins à dissection | 93 |
| REZEK-HEANEY Pincés à hystérectomie | 196 |
| RICARD Ecarteurs abdomiaux | 298 |
| RICHARDSON-EASTMAN Ecarteurs | 250 |
| RICHARDSON Ecarteurs | 251 |
| RICHTER-HEATH Pince à retirer les agrafes | 379 |
| RICHTER Ciseaux pour opération | 80 |
| RIENHOFF-FINOCHIETTO Ecarteur à côtes | 506 |
| ROBB Spatules et dilatateurs pour la tunique interne | 512 |
| ROBERTS Pincés hémostatiques | 178 |
| Robinets | 333 |
| ROBSON-MAYO ATRAUMATIC-GRIP Pincés-clamps intestinales | 396 |
| ROBSON-MAYO Pincés-clamps intestinales | 396 |
| ROCHARD Compas articulé | 309 |
| ROCHARD Ecarteurs abdomiaux | 309 |
| ROCHESTER-CARMALT Pincés hémostatiques | 178 |
| ROCHESTER-OCHSNER Pincés hémostatiques | 178 |
| ROCHESTER-PEAN Pincés hémostatiques | 175 |
| ROEDER Pincés à compresses | 201 |
| ROGERS HEANEY-DE BAKEY Pincés à hystérectomie | 197 |
| ROGERS WERTHEIM-DE BAKEY Pincés à hystérectomie | 197 |
| ROGGE Pince à stérilisation | 734 |
| ROLLET Ecarteur | 218 |
| Rongeurs crâniens | 688 |
| ROSCHKE Dilatateur pour anus | 407 |
| ROSE Ecarteur double | 227 |
| ROSEGGER-KLIMA Aiguilles à ponction sternale | 329, 518 |
| ROSEN Canules d'aspiration | 320 |
| ROSER-KÖNIG ouvre-bouches | 22 |

| | |
|---|------------------|
| RÖTTGEN-RUSKIN Pince-gouge | 636 |
| ROUX Ecarteurs doubles..... | 229 |
| Ruban | 6 |
| Ruban métrique..... | 6 |
| Ruban métrique acier | 6 |
| Ruban métrique toile cirée..... | 6 |
| RUDD Ligateur hémorroïdal..... | 410 |
| Rugines-raspatoires | 582-591, 694-697 |
| Rugines-raspatoires avec manche en „Ferrozell“..... | 590-591 |
| Rugines à costales..... | 495, 497 |
| Rugines à périostomie | 496 |
| RUMEL-BELMONT Tourniquets | 518 |
| RUMEL-DE BAKEY Pincés à disséquer et à ligatures | 186 |
| RUMEL Pincés à disséquer et à ligatures | 186 |
| RUSKIN-LISTON Pincés coupantes | 638 |
| RUSKIN-RÖTTGEN Pince-gouge | 636 |
| RUSKIN-STILLE Pince-gouge..... | 636 |
| RUSKIN Pince coupante | 638 |
| RUSKIN Pincés-gouges | 633-634 |
| RUSS. MODELL Pincés pour vaisseaux et tumeurs..... | 149 |
| RUST Scie à amputation et résection..... | 573 |
| RYDER-LANGENBECK TITE GRIP Porte-aiguilles | 350 |
| RYDER-SEIFFER Diapason pour neurologie | 4 |
| RYDER-VASCUALR TITE GRIP Porte-aiguilles | 340 |
| RYDER TITE GRIP Porte-aiguilles..... | 340 |

S

| | |
|--|----------|
| SAALFELD Tire-comédons | 19 |
| SACHS Crochet pour fistules..... | 221 |
| SACHS Crochet pour la dure-mère | 217 |
| SACHS Dissecteurs pour la dure-mère | 698 |
| SACHSE Méatotome | 426 |
| SAENGER Pincés placentaires et pour poste-abortum..... | 483 |
| SALENIUS Bistouris à ménisque..... | 642 |
| SALING Amnioscopes..... | 472 |
| SAMII-YASARGIL Pincés pour saisir tumeurs et tissus | 126 |
| SAMII Pincés pour saisir tumeurs et tissus | 127 |
| SANVENERO Ciseaux pour chirurgie plastique | 70 |
| SAROT Pincés-clamps à bronches | 566 |
| SAROT Pincés hémostatiques fines | 171 |
| SAROT TITE-GRIP Porte-aiguilles..... | 344 |
| SATINSIKY Ciseaux pour la veine cave..... | 99 |
| SATINSKI-BABY Pincés-clamps à anastomose (veine cave)..... | 565 |
| SATINSKI Pincés-clamps à anastomose (veine cave) | 565 |
| SATINSKY-DE BAKEY ATRAUMATIC-GRIP Clamps Bulldog | 525 |
| SATINSKY-DE BAKEY ATRAUMATIC-GRIP Pincés vasculaires pour occlusion tangentielle | 541 |
| SATTERLEE Scie à amputation et résection | 572 |
| SAUER Pince fine chirurgicale..... | 138 |
| SAUERBRUCH-FREY Costotome..... | 493 |
| SAUERBRUCH-SCHNEIDER Rugine-raspatoire | 588 |
| SAUERBRUCH Boîtes pour stériliser des aiguilles de suture..... | 357 |
| SAUERBRUCH Costotome | 492 |
| SAUERBRUCH Ecarteurs | 242 |
| SAUERBRUCH Pincés à déchets | 735 |
| SCALP CONTOUR Ecarteurs autostatiques | 276 |
| Scapula, Ecarteurs | 260 |
| SCHAAF Pince à épiler | 152 |
| SCHÄDEL Pincés à compresses | 200 |
| SCHAMBERG Tire-comédons | 19 |
| SCHUDE Curettes | 602 |
| SCHERBACK Spéculums vaginaux..... | 442 |
| SCHINK Dermatome | 41 |
| SCHMID Aiguilles vasculaires pour irrigation..... | 322 |
| SCHMID Spatules pour la tunique interne | 513 |
| SCHMIEDEN-TAYLOR Ciseaux pour dure-mère | 100 |
| SCHMIEDEN Spatules conductrices | 378 |
| SCHNEIDER-SAUERBRUCH Rugine-raspatoire | 588 |
| SCHNEIDER Rugine-raspatoires | 588 |
| SCHNIDT Pincés hémostatiques et pour amygdales | 179 |
| SCHOEMAKER-LOTH Ciseaux à ligatures | 352 |
| SCHRÖDER Curettes utérines..... | 466 |
| SCHRÖDER Pincés pour abaissement du col de l'utérus..... | 452, 454 |
| SCHUBERT Pincés emporte-pièces à biopsie | 461 |
| SCHULTZE Salpingographie | 474 |
| SCHUMACHER Ciseaux pour le cordon ombilical | 108 |
| SCHUMACHER Pincés emporte-pièces à biopsie | 463 |

| | |
|---|---------|
| SCHWARTZ Applicateur pour clips vasculaires | 155 |
| SCHWARTZ Serre-Fines | 155 |
| Scie oscillante à plâtre | 680 |
| Scie pour appareils plâtrés..... | 679 |
| Scie, Fils | 687 |
| Scie, Poignées | 687 |
| Scies à amputation et résection | 572-573 |
| Scies pour bagues..... | 645 |
| Scies, Conducteur | 687 |
| SCOVILLE-HAVERFIELD Ecarteur pour laminectomie | 286 |
| SCOVILLE (TOENNIS-OLIVECRONA) Pince pose clips | 690 |
| SCOVILLE Ecarteur pour laminectomie | 286 |
| SCOVILLE Rétracteurs pour racines nerveuses..... | 701 |
| SCOVILLE Valves latérales | 287 |
| SCUDDER ATRAUMATIC-GRIP Pincés-clamps stomacales | 397 |
| SEALY Ciseaux chirurgicaux fins..... | 68 |
| SEBILEAU Élévateur..... | 575 |
| SEDILLOT Rugines-raspatoires..... | 586 |
| SEGOND Pincés à hystérectomie | 195-196 |
| SEIFFER-RYDER Diapason pour neurologie | 4 |
| SELETZ-GELPI Ecarteur vulvaire | 281 |
| SELLHEIM Levier obstétrique | 481 |
| SELLORS Ecarteur et rapprocheur | 508 |
| SEMB Daviers à os..... | 493 |
| SEMB Ecarteur à poumons | 260 |
| SEMB Pincés-gouges | 494 |
| SEMB Pincés à disséquer et à ligatures | 564 |
| SEMB Pincés coupantes à os | 494 |
| SEMB Rugines à périostomie | 496 |
| SEMKEN Pincés fines à dissection | 130 |
| SEMKEN Pincés fines chirurgicales..... | 142 |
| SEMKEN TITE-GRIP Pince à dissection | 113 |
| SEMKEN TITE-GRIP Pincés à dissection à griffes | 117 |
| SEMM Ecarteur abdominal | 305 |
| SEMM Spéculums vaginaux | 432 |
| SENN-GREEN Ecarteurs | 224 |
| SENN-MILLER Ecarteurs doubles | 226 |
| Septum, Ciseaux DURACUT | 59 |
| Séquestre, Pincés | 623 |
| Seringue pour tuberculine | 330 |
| Seringues | 330-332 |
| Seringues auriculaires | 332 |
| Seringues pour insuline | 330 |
| Seringues vésicales..... | 331 |
| Serre-fil | 660 |
| Serre-fils, pincés TITE GRIP | 662 |
| Serre-Fines | 154-156 |
| Set pour la biopsie vertébrale CRAIG-KOLGER | 720-721 |
| SEUTIN Cisailles pour étoffes d'habillement et appareils plâtrés | 675 |
| SEWALL Rugine-raspatoire..... | 582 |
| SIEBOLD-SIMS Ciseaux utérins | 106 |
| SIEBOLD Ciseaux utérins | 106 |
| SILVER Dermatomy | 41 |
| SIMON-HEANEY Ecarteur pour interventions en profondeur | 254 |
| SIMON Crochet pour fistules | 221 |
| SIMON Curettes | 605 |
| SIMON Curettes utérines | 466 |
| SIMON Ecarteur pour interventions en profondeur | 254 |
| SIMPSON-BRAUN Forceps..... | 478 |
| SIMPSON Hystéromètre | 446 |
| SIMS-MAIER Pincés à pansements et tampons..... | 205 |
| SIMS-SIEBOLD Ciseaux utérins | 106 |
| SIMS Ciseaux pour gynécologie DURACUT | 60 |
| SIMS Ciseaux utérins | 104-105 |
| SIMS Ciseaux utérins DURACUT | 60 |
| SIMS Curettes utérines | 467 |
| SIMS Hystéromètres | 446 |
| SIMS Spéculums rectaux | 405-406 |
| SIMS Spéculums vaginaux | 438 |
| SINGLEY TUTTLE Pincés à dissection des poumons | 149 |
| Sinus maxillaire, Trocarts | 319-320 |
| SMELLIE Perce-crâne..... | 485 |
| SMILLIE Bistouris à ménisque | 643 |
| SMILLIE Ecarteurs pour genou | 641 |
| SMITH-BUIE Dilatateur pour anus et rectum | 408 |
| SMITH-FERRIS-CUSHING Pincés emporte-pièces à laminectomie | 713 |
| SMITH-FERRIS Pincés chirurgicales | 147 |
| SMITH-HEYWOOD Pince à polypes et ovaires | 457 |
| SMITH-HEYWOOD Pincés tire-langue..... | 23 |

SMITH-KERRISON-FERRIS Pincés emporte-pièces à laminectomie 709-711
SMITH-POTTS Ciseaux vasculaires DURACUT 56
SMITH-POTTS Ciseaux à dissection 98
SMITH-POTTS Ciseaux vasculaires 96-98
SMITH-POTTS Pincés fines à dissection 131
SMITH-POTTS Pincés fines chirurgicales 143
SMITH Ciseaux à pansements 672
SOFT-GREGORY ATRAUMATIC-GRIP Clamps Bulldog
avec denture **DE BAKEY** 527
SOFT-GREGORY Pincés-clamps pour la carotide 527
Soie à suture 353
SOMER Pince hystérolabe 458
Sonde-curette pour vésicule biliaire 415
Sonde boutonée 694
Sonde double 694
Sonde pour mesurer 450
Sondes 314, 450-451
Sondes à endartérectomie 514
Sondes auriculaires 322
Sondes boutonées 312-313
Sondes boutonées cannelées 314
Sondes cannelées 314
Sondes conductrices 377
Sondes pour fistules 314, 409
Sondes rectales 409
Sondes vésicales métalliques 424
Spatule pour la tunique interne 513
Spatule pulmonaire 260
Spatules à goitres 378
Spatules abdominales et intestinales 266-267
Spatules cérébrales 706
Spatules conductrices 378
Spatules de laryngoscopie 25, 27, 29, 31
Spatules de laryngoscopie avec lumière froide 27, 31
Spatules et dilataeurs pour la tunique interne 512
Spatules et écarteurs pulmonaires 261-265
Spatules vésicales 268
Spatules, support 703
Spécula pour la hypophysectomie 692
Spéculum latéral 448
Spéculums et valves vaginaux 434-437, 439
Spéculums pour urètre et col utérin 448
Spéculums rectaux 405-406
Spéculums vaginaux 430-442
SPENCER-WELLS Pincés hémostatiques 173
SPENCER (NORTHBENT) Ciseaux à ligatures 352
SPENCER Ciseaux à ligatures 352
Sphinctéoscopes 407
Spinale, Gouge 616
Spongiose, Ciseaux-burins 615
SPRATT Curettes 602
SPURLING Pincés emporte-pièces à laminectomie 717, 719
ST. MARKS Ecarteurs pour interventions en profondeur 258
ST. MARTIN Pince fine chirurgicale 139
STACKE Sonde boutonée 313
STADLER-BRAUN Ciseaux à périmée 107
STANDARD-YASARGIL Applicateurs pour clips vasculaires 154
STANDARD-YASARGIL Serre-Fines 154
STAUDE-MOORE Pince pour abaissement du col de l'utérus 452
STEINMANN Clous 654
STEINMANN Pince à saisir les tendons 647
STELLBRING Pincés-gouges 632
STELZNER CRAFOORD Ciseaux à lobectomie et pour le rectum 99
Stérilisation des aiguilles à suture, Support 736
Stérilisation et coservation, Boîtes 738
Stérilisation, Boîtes 739-741
Stérilisation, Boîtes en plastigue 742
Stérilisation, Boîtes rondes 743
Stérilisation, Cadres 737
Stérilisation, Chevalets 737
Stérilisation, Paniers 745
Stérilisation, Plateaux 744
Sternotomie, Ecarteurs 499
Sternotomie, Ecarteurs en ALUMINIUM 498
Sternum, Ciseau-burins et cisaille 492
Stéthoscopes 5
Stéthoscopes combiné en métal léger 5
Stéthoscopes en aluminium 5
Stéthoscopes en bois 5

STEVENS Ciseaux fins à dissection 92
STEVENS Ciseaux fins à dissection avec grands anneaux ergonomiques 92
STIEGLITZ (WILLIAMS) Pincés à écharde 151
STILLE-BARRAYA Pincés vaisseaux et tumeurs 148
STILLE-CRAFOORD Pincés hémostatiques fines 170
STILLE-DOYEN Ecarteurs 247
STILLE-GIERTZ Costotome 492
STILLE-LEKSELL Pincés-gouges 635
STILLE-LUER Pincés-gouges 634, 636
STILLE-MAYO Ciseaux à dissection 85
STILLE-MAYO Ciseaux à dissection DURACUT 48
STILLE-MINI Cisailles pour appareils plâtrés 677
STILLE-RUSKIN Pince-gouge 636
STILLE-STRANDELL Ecarteurs à gaines tendineuses 225
STILLE Cisailles pour appareils plâtrés 677, 678
STILLE Ciseaux-burins 610
STILLE Gouges 610
STILLE Ostéotomes 610
STILLE Perforateur à main 651
STILLE Pince-gouge 635
STOCKMANN Compresseur de l'urètre 426
Stomacales, Pincés-clamps ATRAUMATIC-GRIP 397
STRANDELL-STILLE Ecarteurs à gaines tendineuses 225
STRATTE TITE GRIP Porte-aiguilles 347
STRAUSS Compresseur de l'urètre 426
Strippers à tendons 646
Strippers à varices 315
STRULLY Ciseaux pour la neuro-chirurgie 100
Styler feuille de sauge 313
Stylets 312-313
Stylets aiguillés 313
Stylets pour le canal lacrymal 312
SUBRAMANIAN Pincés-clamps pour aorte 537
SULLIVAN BROPHY Ciseaux fins à dissection 93
SUPER Stéthoscopes combiné en métal léger 5
Support de main 644
Support pour stériliser les aiguilles à suture 736
Supports porte-agrafes 690-691
Supports pour spatules 703
Suture, Appareil 404
Suture, Instruments 378, 690-691
Suture, Soie 353
Sutures, Aiguilles 354-356
Sutures, Nécessaire 380
SWEET-LAHEY Pincés à disséquer et à ligatures 189
SWITZERLAND (MOD.) Micro-pincés (modèles horloger) 120
SYSTRUNK Ciseaux à fendre les ongles 81

T

Table d'opération, Ecarteurs pour fixation 704
TAKAHASHI Pincés emporte-pièces à laminectomie 714
Tampons et éponges, Pincés 209-210
Tampons et pansement, Pincés 204-207
TARNIER Forceps 480
TAYLOR-CUSHING Pince fine pour dissection 131
TAYLOR-CUSHING Pincés auriculaires et nasales 136
TAYLOR-CUSHING TITE-GRIP Pince à dissection 114
TAYLOR-CUSING Pince fine chirurgicale 143
TAYLOR-SCHMIEDEN Ciseaux pour dure-mère 100
TAYLOR Marteaux à réflexes 2
TAYLOR Valves latérales 287
TEALE Pincés pour abaissement du col de l'utérus 456
Tendeur de broches 658
Tendons, Conducteurs 646, 648
Tendons, Pincés à saisir 647
Tendons, pincés pour entrelacer 649
Tendons, Strippers 646
Tendons-passe, Pincés 649
Ténotome 37
Ténotomie et dissection, Ciseaux fins 92
Têtes d'accouplement 705
THOMAS-PRICE Pincés-clamps à bronches 566
THOMS-ALLIS Pince à préhension de l'intestin 385
THOMS-GAYLOR Pince emporte-pièces à biopsie 460
Thoracique et pour ligatures, Pince 564
Thoracique, Ecarteur 507
THOREK-METZENBAUM Ciseaux adnex DURACUT 54

- THOREK** Ciseaux à dissection 98
THORLAKSON ATRAUMATIC-GRIP Pincers-clamps à occlusion 398-399
THORLAKSON Ecarteurs doubles 230
THORLAKSON Ecarteurs pour interventions en profondeur 256-257
 Tire-broches, Pincers 663-664
 Tire-comédons 19
TISCHLER-MORGAN Pince emporte-pièces à biopsie 464
TISCHLER-BABY Pince emporte-pièces à biopsie 464
TISCHLER Pincers emporte-pièces à biopsie 465
 Tissu mou, Tréphine de ponction 721
 Tissus et aiguilles, TITE GRIP Pincers pour saisir et tirer 116
 Tissus et peau, Crochet double pour saisir et soulever 212
 Tissus et tumeurs, Pincers pour saisir 126-127
 Tissus moux, Double griffe pour extraction 721
 Tissus, Micro-pincers 124
 Tissus, Pincers 149
TITAN-LINE Clamps Bulldog 160-161
TITAN-LINE Pince pour poser et retirer les clamps Bulldog en titane 160
TITAN-LINE Porte-aiguilles 365
TITANE CRILE Pincers hémostatiques fines 166
TITANE HALSTED-MOSQUITO Pincers hémostatiques fines 164
TITANE KELLY Pincers hémostatiques fines 168
TITANE Pincers hémostatiques fines 164, 166, 168
TITANE, Micro-pincers à ligatures 123
TITANE, Micro-pincers pour saisir les tissus 124
TITANE, Micro-Porte-aiguilles 362
TITE GRIP Micro-Pincers 118
TITE GRIP Pincers 118
TITE GRIP Pincers-Micro 118
TITE GRIP Pincers à dissection 113-115, 117
TITE GRIP Pincers à dissection à griffes 117
TITE GRIP Pincers à dissection modèles standard 115
TITE GRIP Pincers à ligatures 113
TITE GRIP Pincers pour saisir les tissus et tirer les aiguilles 116
TITE GRIP Micro-Porte-aiguilles 338-339
TITE GRIP Pincers serre-fils 662
TITE GRIP Porte-aiguilles 340-350
TITE GRIP Porte-aiguilles pour gauchers 341
TITE GRIP Râpes 596-597
TOENNIS-ADSON Ciseaux à dissection 89
TOENNIS-ADSON Ciseaux à dissection DURACUT 49
TOENNIS-OLIVECRONA (SCOVILLE) Pince pose clips 690
TOENNIS Ciseaux à chirurgie et à dissection 83
TOENNIS Ciseaux à dissection et à chirurgie 83
TOENNIS Dissecteurs pour la dure-mère 700
TOENNIS Porte-aiguilles 371
TOENNIS TITE GRIP Porte-aiguilles 350
TOHOKU Pincers pour champs en papier 202
TÖNNIS Couteaux pour dure-mère 37
 Tourniquets 518
TOWNSEND Pincers emporte-pièces à biopsie 465
 Trachée, Ecarteur 226
 Trachéotomie, Canules 725-727
 Trachéotomie, Dilatateurs 728
 Trachéotomie, Ecarteurs 217, 219-220, 728
 Trachéotomie, Instruments 728-730
 Trachéotomie, Jeu d'instruments 729-730
 Trachéotomie, Trocarts avec canule argent 728
 Tracteurs pour fibrome 458
 Traction crânienne, Alésoirs pour étirer 689
 Traction crânienne, Etriers 689
 Traction crânienne, Pincers 689
 Transformateur pour bandeaux frontaux 11
 Transformateurs 11, 472
TRELAT Rugine-raspatoire 582
TRELAT Spéculum vaginaux 431
 Trépan cutané 20
 Tréphine de ponction pour os 721
 Tréphine de ponction pour tissu mou 721
 Triangulaires, Bassins 750
 Trocart, Canule 721
 Trocarts 318, 721
 Trocarts pour la trachéotomie avec canule argent 728
 Trocarts pour le sinus maxillaire 319-320
TROELTSCH (WILDE) Pincers auriculaires et nasales 137
TROELTSCH Pincers auriculaires et nasales 137
TROEMNER Marteaux à réflexes 3
TROUSSEAU Dilatateur pour la trachéotomie 728
 Trousses à laryngoscopie 24, 26, 30
 Trousses à laryngoscopie lumière froide 26, 30
TROUTMAN-BARRAQUER Micro-Porte-aiguilles 360
TROUTMAN Pincette pour saisir et casser les lames de rasoir 36
TUBBS Dilatateur aortique 511
 Tube compressif 570
 Tube plastique 473
 Tubes et cathéters, Pince conductrice 473
TÜBINGEN (MOD.) VANNAS Micro-ciseaux 62
TUFFIER Ecarteur à côtes 506
TUFFIER Spatules abdominaux et intestinaux 267
 Tumeurs et tissus, Pincers pour saisir 126-127
 Tumeurs et vaisseaux, Pincers 148-149
 Tunique interne, Couteau 513
 Tunique interne, Spatules 513
 Tunique interne, Spatules et dilatateurs 512
 Tunnelisateur avec manche 517
 Tunnelisateur pour bypass 517
 Tunneliser, Jeu 516
 Tunnelisateur, Pince 517
TUOHY Aiguilles pour ponction lombaire 328
TUTTLE (SINGLEY) Pincers à dissection des poumons 149
TYRELL GRAEFE Crochets à peau 216
- ## U
- UCKERMANN** Porte-cotons 317
UECKERMANN-DENKER Trocarts pour la trachéotomie
 avec canule argent 728
UFFENORDE Curettes 601
ULRICH Bistouris pour fistules 37
ULRICH Daviers 627
ULRICH Pincers à pansements et tampons 206
UNIVERSAL Pincers coupe-fils 665
UNIVERSAL Trocarts 318
UNNA-VIDAL Tire-comédons 19
UNNA Tire-comédons 19
 Uréthrographe 426
 Urètre, Compresseur 426
 Urologie, Instruments 425-426
US-ARMY (PARKER-LANGENBECK) Ecarteurs 231
USA (MOD.) Ciseaux pour le cordon ombilical 108
USA (MOD.) Pincers à dissection modèles étroits 133
USA (MOD.) Pincers à dissection modèles standard 133
USA (MOD.) Pincers chirurgicales 145
USA MOD. Curettes 601
USA MOD. Pince écartantes à plâtre 682
 Utérine, Pince-clamp pour hémostase 481
 Utérines, Curettes 466-470
 Utérins, Ciseaux 104-106
 Utérins, Ciseaux DURACUT 60
 Utérus, Dilatateurs du col 443-445
- ## V
- V.EICKEN LICHTWITZ** Trocarts pour ponction du sinus maxillaire 319
 Vaisseaux et nerf, Crochets 213-215
 Vaisseaux et tumeurs, Pincers 148-149
 Vaisseaux, Couteaux 694-695
VALLEIX Hystéromètre 446
 Valves 293
 Valves en VINYL pour écarteurs abdominal **FOERSTER** 308
 Valves et spéculums vaginaux 434-437, 439
 Valves latérales 287, 289, 293
 Valves pour écarteurs abdominaux **KIRSCHNER-BALFOUR** 307
 Valves pour écarteurs abdominaux **KIRSCHNER** 307
VAN BUREN Bougies dialatatrices 424
VAN BUREN Pince à séquestre 623
VAN DOREN Pince emporte-pièces à biopsie 461
VANNAS-YASARGIL Micro-ciseaux 66
VANNAS Micro-ciseaux 62, 63, 65
VANNAS MOD. TÜBINGEN Micro-ciseaux 62
VARCO Pincers hémostatiques fines 170
 Varices, Strippers 315
 Vasculaires et Fistules, Ciseaux 80
 Vasculaires périphériques, Pincers-clamps 534
 Vasculaires périphériques, Pincers-clamps avec
 denture **DE BAKEY** ATRAUMATIC-GRIP 535-536

| | |
|--|-------------------|
| Vasculaires, Aiguilles | 354 |
| Vasculaires, Applicateurs pour clips | 154-155 |
| Vasculaires, Ciseaux | 95-98 |
| Vasculaires, Ciseaux DURACUT | 56-57 |
| Vasculaires, Dilatateurs | 510 |
| Vasculaires, Pincés ATRAUMATIC-GRIP | 520 |
| Vasculaires, Pincés avec denture COOLEY ATRAUMATIC-GRIP | 555-562 |
| Vasculaires, Pincés avec denture DE BAKEY ATRAUMATIC-GRIP | 529-530, 537, 554 |
| Vasculaires, Pincés avec denture LAWTON ATRAUMATIC-GRIP | 521-523 |
| Vasculaires, Pincés pour occlusion tangentielle ATRAUMATIC-GRIP | 541 |
| Vasculaires, Pincés pour poser les clips vasculaires | 156 |
| Vasculaires, Pincés semi flexible | 563 |
| VASCULAR Porte-aiguilles | 364 |
| VASCULAR TITAN-LINE Porte-aiguilles | 365 |
| Veine cave, Ciseaux | 99 |
| Veine cave, Pincés-clamps avec denture DE BAKEY ATRAUMATIC-GRIP | 550 |
| Veines et hile rénal, Ecarteurs | 223 |
| Veines, Ciseaux-micro | 63 |
| Veines, Ecarteurs | 217, 222-223 |
| VERBRUGGE-MÜLLER Leviers à os | 579 |
| VERBRUGGE Daviers | 628 |
| VERESS Aiguilles pour le pneumopéritoine | 329 |
| VERNET-GIL MARBERGER Ecarteur à veines et à hile rénal | 223 |
| Vésicale, Dilatateur | 423 |
| Vésicales, Sondes métalliques | 424 |
| Vésicales, Spatules | 268 |
| Vésicaux, Ecarteurs | 310 |
| Vésicule biliaire, Cuiller | 417 |
| Vésicule biliaire, Sonde-curette | 415 |
| VICKERS Distributeur de broches filiformes | 657 |
| VICKERS Ecarteurs pour doigts | 271 |
| VICKERS Ecarteurs pour mains | 271 |
| VICKERS Support de main | 644 |
| VIDAL-UNNA Tire-comédons | 19 |
| VIDAL Grattoir pour lupus | 19 |
| VRICHOW Couteau à cerveau | 40 |
| Vis pour fixation des disques | 659 |
| WISE Micro-pincés à ligatures | 122 |
| VOGEL Trocart pour la ponction du sinus maxillaire | 319 |
| Voies biliaires, Dilatateurs | 415 |
| VOLKMANN Curettes | 600, 602, 606 |
| VOLKMANN Ecarteurs | 232-234 |
| VOLKMANN Ecarteurs et Ecarteurs à os | 232 |
| VON PETZ Appareils pour la suture gastro-intestinale | 404 |
| Vulvaires, Ecarteurs | 281 |

W

| | |
|--|---------|
| WAGENER Crochets à nerfs et à vaisseaux | 213 |
| WAGNER Levier à os | 577 |
| WAGNER Maillets | 620 |
| WAGNER Rugines-raspatoires avec manche en „Ferrozell“ | 591 |
| WALB Couteau à autopsie | 40 |
| WALDMANN Ciseaux à périnée | 107 |
| WALTON-LISTON (BÖHLER) Pincés coupantes | 638 |
| WANGENSTEEN Porte-aiguilles | 369 |
| WANGENSTEEN TITE GRIP Pincés à dissection | 115 |
| WANGENSTEEN TITE GRIP Porte-aiguilles | 347 |
| WARTENBERG Algésimètre | 4 |
| WATSON-CHEYNE Dissecteur | 574 |
| WATSON-WILLIAMS Râpe | 593 |
| WAUGH Pince fine à dissection | 131 |
| WAUGH Pince fine chirurgicale | 143 |
| WEBER Aesthésiomètre | 4 |
| WEBER ATRAUMATIC-GRIP Pincés-clamps pour anastomose de l'aorte avec denture DE BAKEY | 548 |
| WEBSTER Porte-aiguilles | 363 |
| WEBSTER TITE-GRIP Porte-aiguilles | 342 |
| WEIL-BLAKESLEY Pincés emporte-pièces à laminectomie | 714 |
| WEISSBARTH Spéculum vaginal | 442 |
| WEITLANER Ecarteurs autostatiques | 272-274 |
| WELLS-SPENCER Pincés hémostatiques | 173 |
| WERTEHIM-DE BAKEY (ROGERS) Pincés à hystérectomie | 197 |
| WERTEHIM BOZEMANN TITE-GRIP Porte-aiguilles | 346 |
| WERTHEIM-CULLEN Pincés-clamps pour pédicules rénaux | 191 |
| WERTHEIM Ciseaux utérins | 105 |

| | |
|---|---------------|
| WERTHEIM Pincés à hystérectomie | 194-195 |
| WEST Ciseaux-burins | 607 |
| WEST Gouges | 607, 612, 614 |
| WIENER MOD. Porte-ligature | 378 |
| WIENER Râpes | 593 |
| WILDE TROELTSCH Pince auriculaires et nasales | 137 |
| WILLETT Pince pour le cuir chevelu | 481 |
| WILLIAMS-WATSON Râpe | 593 |
| WILLIAMS Pince à préhension de l'intestin | 388 |
| WILLIAMS STIEGLITZ Pincés à échardes | 151 |
| WILLIGER Curettes | 598, 600 |
| WILLIGER Elévateurs | 574 |
| WILLIGER Maillet | 617 |
| WILLIGER Rugine-raspatoire | 582 |
| WINTER Pincés placentaires et pour poste-abortum | 482 |
| WINTER Stéthoscopes en bois | 5 |
| WITTNER Pincés emporte-pièces à biopsie | 462 |
| WOLFF Pincés écrasantes pour plâtre | 682 |
| WOLFSON-DE MARTEL Clamps pour anastomose | 402 |
| WOLFSON-DE MARTEL Pince pour fermer les clamps | 402 |
| WOLFSON-DE MARTEL Porte-clamps | 402 |
| WOOD-CRILE Porte-aiguilles | 366, 368 |
| WOOD-CRILE TITE GRIP Porte-aiguilles | 343 |
| WOOD-CRILE TITE GRIP Porte-aiguilles pour gauchers | 341 |
| WRIGLEY Forceps | 480 |
| WULLSTEIN Canules d'aspiration | 321-322 |
| WULLSTEIN Ecarteurs autostatiques | 275 |
| WYLLIE ATRAUMATIC-GRIP Pincés-clamps pour anastomose de l'aorte avec denture DE BAKEY | 549 |

Y

| | |
|--|----------|
| YANKAUER Canule d'aspiration | 325-326 |
| YASARGIL-MINI Applicateurs pour clips vasculaires | 154 |
| YASARGIL-MINI Serre-Fines | 154 |
| YASARGIL-SAMII Pincés pour saisir tumeurs et tissus | 126 |
| YASARGIL-STANDARD Applicateurs pour clips vasculaires | 154 |
| YASARGIL-STANDARD Serre-Fines | 154 |
| YASARGIL-VANNAS Micro-ciseaux | 66 |
| YASARGIL Canules d'aspiration | 324 |
| YASARGIL Couteaux pour vaisseaux | 695 |
| YASARGIL Crochet à molle pour fixer la galea | 691 |
| YASARGIL Curette tranchante | 695 |
| YASARGIL Dissecteur | 694 |
| YASARGIL Micro-ciseaux | 66-67 |
| YASARGIL Micro-pincés | 125 |
| YASARGIL Passe-fils | 697 |
| YASARGIL Pince pour l'hypophyse | 719 |
| YASARGIL Pincés pour saisir tumeurs et tissus | 126 |
| YASARGIL Rugines-raspatoires | 694-695 |
| YEOMAN Pincés à biopsie rectale | 412 |
| YOUNG-HRYNTSCHAK Porte-aiguilles boomerangs | 372 |
| YOUNG-MILLIN Porte-aiguilles boomerangs | 372 |
| YOUNG Crochet en bulbus | 422 |
| YOUNG Ecarteurs prostatiques | 422 |
| YOUNG Pince tire-langue | 23 |
| YOUNGE-KEVOURKIAN Curettes pour biopsie | 459 |
| YOUNGE-KEVOURKIAN Pince emporte-pièces à biopsie | 463, 465 |

Z

| | |
|--|-----|
| ZAUFAL-JANSEN Pince-gouge | 633 |
| ZENKER Ecarteurs pour interventions en profondeur | 259 |
| ZENKER Pincés à disséquer et à ligatures | 188 |
| ZIEGLER Bandeau frontal plastique noir | 10 |
| ZIEGLER Miroir frontal complet | 10 |
| ZOELLNER Canule d'aspiration | 321 |
| ZWEIFEL TITE GRIP Porte-aiguilles | 349 |

A

- Abbassalingua 12
- Abbassare il collo dell'utero, Pinze 452-456
- ABRAMS** Ago per la puntura della pleura 329, 518
- Accessori per autofissatori di retrattori di **LEYLA** 703, 705
- Accoppiamento, Porta asta per teste 705
- ADAIR-ALLIS** Pinza da presa per intestino e tessuti 384
- ADAIR** Pinza per abbassare il collo dell'utero 452
- ADAMS-MAYO** Divaricatori per appendicectomia 284
- Adattatore per la connessione delle curette per aspirazione 471
- Addominali e intestinali, Spatole 266-267
- Addominali, Divaricatori 297-306, 308
- Addominali, Forbici 106
- ADLERKREUTZ** Pinze per chirurgia 148
- Adnex, Forbici **DURACUT** 54
- ADSON-ANDERSON** Divaricatore autostatico 276
- ADSON-BABY** Pinze per preparazioni e legature 180
- ADSON-BECKMANN** Divaricatori per laminectomia 279
- ADSON-BROWN** Pinze fini per chirurgia 141
- ADSON-BROWN** Pinze per dissezione con denti 117
- ADSON-MICRO** Pinze anatomiche per dissezione, fini 129
- ADSON-MICRO** Pinze fini per chirurgia 140-141
- ADSON-MICRO** Pinze per dissezione con denti 117
- ADSON-TOENNIS** **DURACUT** Forbici per dissezione 49
- ADSON-TOENNIS** Forbici per dissezione 89
- ADSON** Cannule per aspirazione con interruttore e stiletto 323
- ADSON** Divaricatore per laminectomia 276
- ADSON** Divaricatore per laminectomia 280
- ADSON** Divaricatori autostatici 273, 278
- ADSON** Divaricatori per emilaminectomia 277
- ADSON** Periostotomi 586
- ADSON** Pinza guida sonda e per la protezione della dura-madre 650
- ADSON** Pinze anatomiche per dissezione, fini 129
- ADSON** Pinze emostatiche fini 169
- ADSON** Pinze fini per chirurgia 140-141
- ADSON** Pinze per dissezione con denti 117
- ADSON** Portaghi 367
- ADSON** Punta a spirale 652
- ADSON TITE GRIP** Pinze anatomiche per dissezione 113
- ADSON** Uncini per nervi e vasi 215
- Aghi chirurgici per sutura 354-356
- Aghi di **REVERDIN** 373
- Aghi di ricambio per portaghi a boomerang 372
- Aghi e tessuti, Pinze **TITE GRIP** 116
- Aghi passafili 661
- Aghi per biopsia 329, 518
- Aghi per il pneumo-peritoneo 329
- Aghi per introduzione 334
- Aghi per la puntura cieca del fegato 329
- Aghi per la puntura dello sterno 329, 518
- Aghi per legatura 374-376
- Aghi per oftalmologia 354
- Aghi per punture lombari 328
- Aghi per sutura intestinale 354
- Aghi per sutura vascolare 354
- Aghi special 328
- Aghi vascolari per irrigazione 322
- Ago per iniezione 486
- Ago per la puntura della pleura 329, 518
- Ago per setto nasale 328
- Ago per tonsille 328
- Ago, Guida 486
- ALAN-PARK** Dilatatore rettale con chiusura a scatto 408
- ALDERDYCE** Dissettori 574
- ALDINGER-HOHMANN** Leve per ossa 580
- Alesatore per pinze di trazione craniale 689
- Aletta nasale, Forbici 81
- ALEXANDER-FARABEUF** Periostotomi costali 497
- ALEXANDER** Osteotomi 609
- ALEXANDER** Pinza per la biopsia cervicale e da prelievo 463
- ALEXANDER** Scalpelli 609
- ALEXANDER** Sgorbie 609
- Algesiometro 4
- ALLEN** Pinze intestinali 390
- ALLIS-ADAIR** Pinza da presa per intestino e tessuti 384
- ALLIS-BABY** Pinze da presa per intestino e tessuti 383
- ALLIS-BOYS** Pinza da presa per intestino e tessuti 384
- ALLIS-JUDD** Pinza da presa per intestino e tessuti 384
- ALLIS-THOMS** Pinza da presa per intestino e tessuti 385
- ALLIS** ATRAUMATIC-GRIP Pinza da presa per intestino e tessuti 389
- ALLIS** Pinze da presa per intestino e tessuti 383-385
- ALLISON** Divaricatore per polmone 260
- ALM** Divaricatori autostatici 270
- ALY** Algesiometro 4
- AMANN** Porta garza uterino 447
- Amnioscopia e il salasso, Strumentario 472-473
- Amnioscopio conico 472
- Amnioscopio per salasso, conico 472
- Amnioscopio, Illuminatore prossimale a luce calda con lampada 472
- Amnioscopio, Illuminatore prossimale a luce fredda 472
- Amniotica, Pinza per la puntura 477
- Amniotomo 477
- Amputazione 570
- Amputazione e resezione, Coltello 39
- Amputazione e resezione, Seghe 572-573
- Amputazione, Coltelli 38
- Amputazione, Retrattore 571
- AN BUREN** Candelette dilatatrici 424
- Anastomosi del colon, Pinze 402
- Anastomosi del retto, Pinze 400-401
- Anastomosi del retto, Pinze ATRAUMATIC-GRIP 400-401
- Anastomosi dell'aorta, Pinze ATRAUMATIC-GRIP 548-549
- Anastomosi, Pinze (vena cava) 565
- Anastomosi, Pinze ATRAUMATIC-GRIP 520-523
- Anastomosi, Pinze con dentatura **COOLEY** ATRAUMATIC-GRIP 559-560
- Anastomosi, Pinze con dentatura **DE BAKEY** ATRAUMATIC-GRIP 542-544
- Anastomosi, Pinze intestinali 402
- Anatomiche, Pinze per dissezione 132-134
- Anatomiche, Pinze per dissezione **TITE GRIP** 112-115
- ANDERSON-ADSON** Divaricatore autostatico 276
- ANDREW-PYNCHON** Tubo aspirazione 325
- Anelli di gomma per legatori 410
- Anelli, Seghe 645
- Aneurisma dell'aorta, Pinza ATRAUMATIC-GRIP 561
- Aneurisma dell'aorta, Pinza con dentatura **DE BAKEY** ATRAUMATIC-GRIP 545-547
- Ano ed il retto, Dilatatori 407-408
- Anoscopi 407
- Anoscopi con otturatore di plastica 407
- Aorta, Dilatatori 511
- Aorta, Pinza per l'aneurisma ATRAUMATIC-GRIP 561
- Aorta, Pinze ATRAUMATIC-GRIP 561
- Aorta, Pinze con dentatura **DE BAKEY** ATRAUMATIC-GRIP 537-540
- Aorta, Pinze per l'anastomosi ATRAUMATIC-GRIP 548-549
- Aorta, Pinze per l'aneurisma ATRAUMATIC-GRIP 545-547
- Apertura del cranio, Strumenti 687
- Apparecchiatura di sutura gastro-intestinale 404
- Apparecchio e lapis per marcare e scrivere 757
- Apparecchio elettrico per marcare e scrivere 757
- Apparecchio per arrestare il sangue nelle estremità 570
- Appendicectomia, Clamp e pinza schiaccia sperone 403
- Appendicectomia, Divaricatori 284
- Applicare e rimuovere clamps, Pinze 527
- Applicare le agrafe emostatiche al cuoio capelluto, Pinza 691
- Applicatori per clips vascolari 154-156
- Approssimatori 157-159
- Approssimatori costali 508
- Apri gesso 682
- Apriboccas 22
- Archi per trazione 654, 658-659
- Archi per trazione, Chiave 659
- Arco di trazione, Cavo 654
- ARMYTAGE-GREEN** Pinza emostatica per tagli cesarei 481
- Arteria coronaria, Forbici 95
- Arterie renali, Pinze emostatiche ATRAUMATIC-GRIP 558
- Arteriostomia, Forbici 95
- ARTHUR** Pinza per schegge 151
- Articoli per infermeria 751
- Asciugamani e spazzole, Cestelli 753
- Aspirazione e prelievo, Curette 471
- Aspirazione intracardiaca, Tubo 327
- Aspirazione nasale, Tubo 324
- Aspirazione, Cannule 320-322
- Aspirazione, Cannule con interruttore e stiletto 323
- Aspirazione, Curette 470
- Aspirazione, Manico 320

| | |
|--|------------------------|
| Aspirazione, Micro-tubo | 321 |
| Aspirazione, Tubi | 324-327 |
| Astuccio per varici | 315 |
| ATRAUMATIC-GRIP Clamp patent-ductus | 556 |
| ATRAUMATIC-GRIP Pinza-clamp per occlusione superiore del retto | 398-399 |
| ATRAUMATIC-GRIP Pinza da presa per intestino e tessuti | 389 |
| ATRAUMATIC-GRIP Pinza iliaca | 558 |
| ATRAUMATIC-GRIP Pinza per aorta | 561 |
| ATRAUMATIC-GRIP Pinze-clamps per parametrio | 197 |
| ATRAUMATIC-GRIP Pinze-clamps per rene | 190 |
| ATRAUMATIC-GRIP Pinze Bulldog | 556 |
| ATRAUMATIC-GRIP Pinze Bulldog con dentatura DE BAKEY | 525-528 |
| ATRAUMATIC-GRIP Pinze coartazione con dentatura COOLEY | 557 |
| ATRAUMATIC-GRIP Pinze emostatica per arteria renale | 537 |
| ATRAUMATIC-GRIP Pinze emostatiche | 176 |
| ATRAUMATIC-GRIP Pinze emostatiche fini | 167 |
| ATRAUMATIC-GRIP Pinze emostatiche per arterie renale | 558 |
| ATRAUMATIC-GRIP Pinze intestinali | 391-393, 395-396 |
| ATRAUMATIC-GRIP Pinze multiuso | 520-523, 530, 556, 562 |
| ATRAUMATIC-GRIP Pinze multiuso con dentatura DARDIK | 554 |
| ATRAUMATIC-GRIP Pinze multiuso con dentatura DE BAKEY | 553 |
| ATRAUMATIC-GRIP Pinze patent-ductus con dentatura DE BAKEY | 531 |
| ATRAUMATIC-GRIP Pinze per anastomosi | 520-523 |
| ATRAUMATIC-GRIP Pinze per anastomosi con dentatura COOLEY | 559-560 |
| ATRAUMATIC-GRIP Pinze per anastomosi con dentatura DE BAKEY | 542-544 |
| ATRAUMATIC-GRIP Pinze per anastomosi del retto | 400-401 |
| ATRAUMATIC-GRIP Pinze per aorta con dentatura DE BAKEY | 537-540 |
| ATRAUMATIC-GRIP Pinze per bronchi con dentatura DE BAKEY | 552 |
| ATRAUMATIC-GRIP Pinze per carotide | 537 |
| ATRAUMATIC-GRIP Pinze per coartazione con dentatura DE BAKEY | 532-533 |
| ATRAUMATIC-GRIP Pinze per dissezione e legature con dentatura DE BAKEY | 551 |
| ATRAUMATIC-GRIP Pinze per isterectomia | 197 |
| ATRAUMATIC-GRIP Pinze per la carotide | 527 |
| ATRAUMATIC-GRIP Pinze per la carotide con dentatura LAWTON | 524 |
| ATRAUMATIC-GRIP Pinze per l'anastomosi dell'aorta | 548-549 |
| ATRAUMATIC-GRIP Pinze per l'aneurisma dell'aorta | 561 |
| ATRAUMATIC-GRIP Pinze per l'aneurisma dell'aorta con dentatura DE BAKEY | 545-547 |
| ATRAUMATIC-GRIP Pinze per occlusione tangenziale | 562 |
| ATRAUMATIC-GRIP Pinze per preparazioni e legature | 186 |
| ATRAUMATIC-GRIP Pinze per profondità | 534 |
| ATRAUMATIC-GRIP Pinze per stomaco | 397 |
| ATRAUMATIC-GRIP Pinze per vasi periferici | 558 |
| ATRAUMATIC-GRIP Pinze per vasi periferici con dentatura DE BAKEY | 534-536 |
| ATRAUMATIC-GRIP Pinze per vena cava con dentatura DE BAKEY | 550 |
| ATRAUMATIC-GRIP Pinze vascolari | 135, 520 |
| ATRAUMATIC-GRIP Pinze vascolari con dentatura COOLEY | 555-556, 558, 561-562 |
| ATRAUMATIC-GRIP Pinze vascolari con dentatura DE BAKEY | 529-530, 534, 537 |
| ATRAUMATIC-GRIP Pinze vascolari con dentatura LAWTON | 521-523 |
| ATRAUMATIC-GRIP Pinze vascolari per occlusione tangenziale | 541 |
| AUFRIEHT Forbici per la chirurgia plastica | 82 |
| AUFRIEHT Raspa | 593 |
| Auricolari e nasali, Pinze | 136-137 |
| Auricolari, Sonde | 322 |
| Auricolari, Uncini | 213 |
| AUSTIN Micro-Pinze per legature | 122 |
| Autofissatore per retrattori cervicale | 704 |
| Autofissatori di retrattori di LEYLA , Accessori | 703, 705 |
| Autofissatori per retrattori, da fissare alla tavola operatoria | 704 |
| Autofissatori per retrattori, per il sopporto del cranio | 702 |
| Autopsia, Coltello | 40 |
| AUVARD-BERLIND Speculi vaginali | 441 |
| AUVARD Speculi vaginali | 441 |
| Avambraccio e divaricatore per la mano | 271 |

B

| | |
|---|----------|
| BABCOCK ATRAUMATIC-GRIP Pinze da presa per intestino e tessuti | 389 |
| BABCOCK Pinze da presa per intestino e tessuti | 385, 388 |
| BABY-ADSON Pinze per preparazioni e legature | 180 |
| BABY-ALLIS Pinze da presa per intestino e tessuti | 383 |
| BABY-BAILEY Approssimatori costali | 508 |
| BABY-BALFOUR Divaricatore addominale | 300 |
| BABY-COLLIN Divaricatore addominale | 297 |

| | |
|--|---------|
| BABY-CRILE Pinze emostatiche fini | 166 |
| BABY-DOYEN ATRAUMATIC-GRIP Pinze intestinali | 391 |
| BABY-DOYEN Pinze intestinali | 391 |
| BABY-FINOCCHIETTO Divaricatori costali | 503 |
| BABY-GELPI Divaricatore per vulva | 281 |
| BABY-GILLIES Portaghi con forbici | 370 |
| BABY-GILLIES TITE GRIP Portaghi | 348 |
| BABY-GOSSET Divaricatore addominale | 299 |
| BABY-HAIGHT-FINOCCHIETTO Divaricatori costali in ALLUMINIO | 501 |
| BABY-KELLY Pinze emostatiche fini | 168 |
| BABY-KOCHER ATRAUMATIC-GRIP Pinze intestinali | 391 |
| BABY-KOCHER Pinze intestinali | 391 |
| BABY-LEXER Forbici per dissezione | 87 |
| BABY-MEEKER Pinze per preparazioni e legature | 180 |
| BABY-METZENBAUM Forbici per dissezione | 89 |
| BABY-MIKULICZ Pinza per peritoneo | 192 |
| BABY-MIXTER Pinze per preparazioni e legature | 180 |
| BABY-MOSQUITO (HARTMANN) Pinze emostatiche fini | 164 |
| BABY-OLSEN-HEGAR TITE GRIP Portaghi | 348 |
| BABY-OVERHOLT Pinza per preparazioni e legature | 183 |
| BABY-PAYR Clamp per intestino e stomaco con perno | 403 |
| BABY-ROUX Divaricatore, doppio | 228 |
| BABY-SATINSKY Pinze per anastomosi (vena cava) | 565 |
| BABY-TSCHLER Pinza per la biopsia cervicale e da prelievo | 464 |
| Bacinelle | 748 |
| Bacinelle reniformi | 750 |
| Bacinelle rettangolari | 748 |
| Bacinelle triangolari | 750 |
| Bacinelle universali | 748 |
| BACKHAUS Pinze per fissare le compresse | 201 |
| BADGLEY Divaricatori per laminectomia | 286 |
| BAHNSON-DE BAKEY ATRAUMATIC-GRIP Pinze per l'aneurisma dell'aorta con dentatura DE BAKEY | 545 |
| BAILEY-BABY Approssimatori costali | 508 |
| BAILEY-GIBBON Approssimatori costali | 508 |
| BAILEY (DE MARTEL) Guida per fili per sega | 687 |
| BAILEY ATRAUMATIC-GRIP Pinze per aorta con dentatura DE BAKEY | 538 |
| BAINBRIDGE-DE BAKEY ATRAUMATIC-GRIP Pinze vascolari | 530 |
| BAINBRIDGE Pinze intestinali | 390 |
| BAKES Dilatore per coledoco | 416 |
| BALFOUR-BABY Divaricatori addominale | 300 |
| BALFOUR-KIRSCHNER Valva per divaricatori addominali | 307 |
| BALFOUR Braccio laterale per divaricatori addominali | 303 |
| BALFOUR Divaricatori addominali | 300-303 |
| BALFOUR modif. Divaricatori addominali | 302 |
| BALFOUR Valve centrali per divaricatori addominali | 303 |
| BALFOUR Valve laterali per divaricatori addominali | 303 |
| BALLENGER-FOERSTER Pinze per tamponi e spugne | 209 |
| BALLENTINE-HEANEY Pinza per isterectomia | 196 |
| BALLENTINE Pinza per isterectomia | 196 |
| BARNES Cannula per aspirazione | 321 |
| BARR Dilatori per l'ano ed il retto | 408 |
| BARRAQUER-TROUTMAN Micro portaghi | 360 |
| BARRAQUER Micro portaghi | 360 |
| BARRAQUER Pinza per ciglia | 152 |
| BARRAYA-STILLE Pinze per chirurgia | 148 |
| BARRETT Pinza per abbassare il collo dell'utero | 452 |
| BARTH Curette per ossa | 599 |
| Base di fissaggio | 703 |
| BAUMGARTNER-HEGAR TITE GRIP Portaghi | 342 |
| BAUMGARTNER Portaghi | 366 |
| BAUMGARTNER TITE GRIP Portaghi | 342 |
| BEACHAM Amniotomo | 477 |
| BECK-COOLEY ATRAUMATIC-GRIP Pinze per anastomosi | 560 |
| BECK-DE BAKEY ATRAUMATIC-GRIP Pinze aorta | 537 |
| BECK-DE BAKEY ATRAUMATIC-GRIP Pinze per anastomosi | 543 |
| BECK-DE BAKEY ATRAUMATIC-GRIP Pinze per vena cava | 550 |
| BECKMANN-ADSON Divaricatori per laminectomia | 279 |
| BECKMANN-EATON Divaricatore per laminectomia | 280 |
| BECKMANN Divaricatore per laminectomia | 280 |
| BEEBEE Forbici taglia cavo | 665 |
| BEER Pinza per ciglia | 152 |
| BELMONT-RUMEL Tourniquets | 518 |
| Bendaggi e vestiti, Cesoie | 674 |
| Bendaggi, Forbici | 672-673 |
| BENGOLEA Pinze emostatiche fini | 172 |
| BENNETT Leve per ossa | 581 |
| BENSON Divaricatore per piloro | 403 |
| BERGER Lente binoculare frontale | 8 |

| | |
|--|----------|
| BERGER Pinza per la biopsia cervicale e da prelievo | 462 |
| BERGMANN Cesioie per vestiti e gessi | 675 |
| BERGMANN Martelli | 621 |
| BERLIND-AUVARD Speculi vaginali | 441 |
| BERLINER Martelli percussori | 2 |
| BERNHARD Pinza per fissare le compresse | 201 |
| BETHUNE Costotomo | 493 |
| BEYER Pinze per laminectomia | 707 |
| BEYER Pinze per ossa | 632-633 |
| Bicchieri per medicinali | 751 |
| BIEMER-MÜLLER Approssimatori | 157 |
| BIEMER Clips vascolari | 156 |
| BIEMER Forbici per vene | 63 |
| BIER Seghe per amputazione e resezione | 573 |
| BILL Manico a trazione | 479 |
| Binoculare frontale, Lente | 8-9 |
| Biopsia cervicale e da prelievo, Pinza | 460 |
| Biopsia dell'endometrio, Curetta | 459 |
| Biopsia dell'endometrio, Curetta aspirante | 459 |
| Biopsia endo-cervicale, Curetta | 459-465 |
| Biopsia ossea, Strumenti | 669 |
| Biopsia rettale, Pinze taglienti | 412 |
| Biopsia vertebrale, Set | 720 |
| Biopsia vertebrale, Strumenti CRAIG-KOGLER | 720-721 |
| Biopsia, Aghi | 329, 518 |
| Biopsia, Curette | 459-460 |
| Biopsia, Strumento per trucoli dell'iliaco | 669 |
| BIRCHER-GANSKE Pinze da presa per menisco e cartilagine | 640 |
| BIRCHER Bisturi per menisco | 643 |
| Bisturi per fistole | 37 |
| Bisturi per intima | 513 |
| Bisturi per menisco | 642-643 |
| Bisturi per rinoplastica | 37 |
| Bisturi per vasi | 694-695 |
| Bisturi, Lame | 34-35 |
| Bisturi, Manici | 34-35 |
| BLAKE-MAYO Pinze per calcoli biliari | 418 |
| BLAKE Curette unterine | 466 |
| BLAKE Pinze per calcoli biliari | 418 |
| BLAKESLEY-WEIL Pinze per laminectomia | 714 |
| BLESSING DURACUT Forbici per la chirurgia rettale | 59 |
| BLOUNT Leve per sciatica | 580 |
| BLOUNT Retrattori per ginocchio | 641 |
| BLUMENTHAL Pinze per ossa | 631 |
| BLUNT Spillo di sicurezza | 736 |
| BOETTCHER Forbici per tonsille | 103 |
| BÖHLER (LISTON-WALTER) Cesioie per ossa | 638 |
| BÖHLER Cavo per arco di trazione | 654 |
| BÖHLER Pinze per ossa | 633 |
| BONN MOD. Pinze fini per chirurgia | 138 |
| BONNEY Pinza anatomica per dissezione | 134 |
| BONNEY Pinze per chirurgia | 147 |
| BONNEY TITE GRIP Pinza anatomica per dissezione | 115 |
| BONNEY TITE GRIP Pinza chirurgica a denti di topo | 118 |
| Boomerang, Portaghi | 372 |
| BOSE Uncino tracheale | 728 |
| BOYS-ALLIS Pinza da presa per intestino e tessuti | 384 |
| BOZEMANN-DOUGLAS Pinza per medicature | 208 |
| BOZEMANN (WERTHEIM) TITE GRIP Portaghi | 346 |
| BOZEMANN Pinze per medicature | 208 |
| Braccio flessibile per il fissaggio delle teste di accoppiamento | 703 |
| Braccio laterale per divaricatori addominali | 303 |
| BRAND Pinza ferma tendine | 648 |
| BRAUN-SIMPSON Forcipi | 478 |
| BRAUN-STADLER Forbici per perineo | 107 |
| BRAUN Cranioclasto | 485 |
| BRAUN Depressore uterino | 447 |
| BRAUN Pinza per abbassare il collo dell'utero | 452, 454 |
| BRAUN Uncino per detroncazione | 485 |
| BRAWLEY Raspa | 593 |
| BREISKY Speculi vaginali | 440 |
| BREISKY Speculi vaginali, doppi | 438 |
| BRIDGE Pinza per preparazioni e legature | 187 |
| BRINKERHOFF Speculi rettali | 406 |
| Bronchi, Pinze con dentatura DE BAKEY ATRAUMATIC-GRIP | 552 |
| BROPHY (SULLIVAN) Forbici fine per dissezione | 93 |
| BROPHY Pinze anatomiche per dissezione, fini | 131 |
| BROPHY Pinze fini per chirurgia | 143 |
| BROWN-ADSON Pinze fini per chirurgia | 141 |
| BROWN-ADSON Pinze per dissezione con denti | 117 |
| BROWN Pinze per chirurgia | 148 |
| BROWN Portaghi | 366 |
| BROWNE-DENIS Divaricatori addominali | 305 |
| BRUENINGS Abbassalingua | 12 |
| BRUNER Divaricatori per interventi in profondità | 252-253 |
| BRUNNER Pinze per anastomosi del retto | 400 |
| BRUNS Cesioie per gessi | 676 |
| BRUNS Curette per ossa | 602-603 |
| BRUNS DURACUT Cesioie per gessi | 676 |
| BUCHWALD Abbassalingua | 12 |
| BUCK-GRAMCKO Leve per ossa | 576 |
| BUCK Martelli percussori | 3 |
| BUELAU Trequarti per empiema | 318 |
| BUIE-SMITH Dilatatori per l'ano ed il retto | 408 |
| BUIE Pinza-clamp a pressione | 409 |
| Bulbo ad uncino | 422 |
| Bulldog, Micro Pinze | 162 |
| Bulldog, Pinza ATRAUMATIC-GRIP | 556 |
| Bulldog, Pinze | 163 |
| Bulldog, Pinze con dentatura DE BAKEY ATRAUMATIC-GRIP | 525-528 |
| Bulldog, Pinze TITAN-LINE | 160-161 |
| BUMM Curette per placenta e ovaie | 484 |
| BUMM Curette uterine | 470 |
| BUNNELL Eucleatore per tendine | 646 |
| BUNNELL Guida per tendine | 646 |
| BUNNELL Trapano a mano per ossa | 653 |
| BURFORD-FINOCHIETTO Divaricatori costali | 503 |
| BURFORD-FINOCHIETTO Divaricatori costali in ALLUMINIO | 502 |
| BURKE Pinza per la biopsia cervicale e da prelievo | 464 |
| BUSH Forbici ombelicali | 108 |
| Bypass, Strumenti per scanalare per trapiantare | 517 |

C

| | |
|--|----------|
| Calcoli biliari, Cucchiari | 417 |
| Calcoli biliari, Pinze | 418-419 |
| Calibratore | 7 |
| CALNE ATRAUMATIC-GRIP Pinze per vena cava con dentatura DE BAKEY | 550 |
| CANAD. MODELL Bisturi per menisco | 643 |
| Canale lacrimale, Stiletti | 312 |
| Candelette dilatatrici | 424 |
| CANNON Bisturi per intima | 513 |
| CANNON Set per endarterectomia | 515 |
| CANNON spatola per intima | 513 |
| CANNON Tiravene per endarterectomia | 514 |
| Cannula per trocar | 721 |
| Cannule parlanti | 726-727 |
| Cannule per aspirazione | 320-322 |
| Cannule per aspirazione con interruttore e stiletto | 323 |
| Cannule per irrigazione del seno mascellare | 322 |
| Cannule tracheali | 725-727 |
| Cannule tracheali, Spazzolino per pulire | 727 |
| CAPLAN DURACUT Forbici per il setto nasale | 59 |
| CARMALT-ROCHESTER Pinze emostatiche | 178 |
| Carotide, Pinze ATRAUMATIC-GRIP | 527, 537 |
| Carotide, Pinze con dentatura LAWTON ATRAUMATIC-GRIP | 524 |
| CAROTIS-DE BAKEY ATRAUMATIC-GRIP Pinze Bulldog | 525 |
| CARROLL Pinza ferma tendine | 648 |
| CARROLL Portaghi | 366 |
| CARROLL TITE GRIP Portaghi | 344 |
| Cartilagine e menisco, Pinze per presa | 640 |
| Cartilagine, Forbici | 82 |
| CASPAR Divaricatore per colonna lombo vertebrale | 294 |
| CASPAR Divaricatore per colonna vertebrale | 288 |
| CASPAR Divaricatori | 245 |
| CASPAR Divaricatori per colonna cervicale | 290-292 |
| CASPAR Periototomi | 585 |
| CASPAR Pinze per laminectomia | 718-719 |
| CASPAR Speculi per chirurgia lombo vertebrale | 295 |
| CASPAR Uncini per nervi e vasi | 215 |
| Cassette per strumenti | 746 |
| CASTANEDA Divaricatori costali in ALLUMINIO | 500 |
| CASTANEDA Pinze multiuso ATRAUMATIC-GRIP | 520 |
| CASTANEDA Pinze per anastomosi ATRAUMATIC-GRIP | 520 |
| Castelli in acciaio perforato per la sterilizzazione | 744 |
| Castello in rete metallica per la sterilizzazione | 744 |

| | | | |
|---|------------------|--|--------------|
| CASTROVIEJO-MICRO Micro portaghi | 358 | CLAR Lampada | 11 |
| CASTROVIEJO Compasso | 7 | CLEVELAND Cesioie per ossa | 637 |
| CASTROVIEJO Pinza per afferrare e rompere le lamette da rasoio | 36 | Clips vascolari | 154-156 |
| CASTROVIEJO Pinze fini per chirurgia | 138 | Clips vascolari, Applicatori | 154-156 |
| CASTROVIEJO Poptaghi | 363 | CLOWARD Divaricatori per colonna cervicale | 285 |
| CASTROVIEJO TITE GRIP Micro-Portaghi | 338-339 | CLOWARD Separatori per vertebre | 296 |
| Catetere guida | 425 | COAKLEY Tre quarti per puntura del seno mascellare | 319 |
| Cateteri e tubi, Pinza guida | 473 | Coartazione, Pinze con dentatura COOLEY ATRAUMATIC-GRIP | 557 |
| Cateteri metallici | 424 | Coartazione, Pinze con dentatura DE BAKEY ATRAUMATIC-GRIP | 532-533 |
| Cateteri o sonde, Strumento per introdurre | 425 | COBB Periostotomi | 589, 591 |
| Catetri, Pinze introduttrici | 32 | COBB Sgorbie spinali | 616 |
| Catgut | 353 | COLCLOUGH (LOVE-KERRISON) Pinze per laminectomia | 710-711 |
| CATLIN Coltello per amputazione | 38 | Colecisti, Cucchiaino | 417 |
| Cava vena, Pinze con dentatura DE BAKEY ATRAUMATIC-GRIP | 550 | Coledoco, Dilatatore | 416 |
| Cavità, Divaricatori | 509 | COLLER-CRILE Pinze emostatiche fini | 167 |
| Cavo per arco di trazione | 654 | COLLIER Portaghi | 363 |
| Cavo, Forbici taglia | 665 | COLLIN-BABY Divaricatore addominale | 297 |
| Cavo, Forbici taglia DURACUT | 665 | COLLIN-DUVAL Pinza per intestino | 149 |
| Cavo, guida | 660 | COLLIN-DUVAL Pinze da presa per intestino e tessuti | 386 |
| Cavo, Pinze gira TITE GRIP | 662 | COLLIN-FARABEUF Periostotomi | 588 |
| Cavo, Pinze porta | 663-664 | COLLIN-HARTMANN Divaricatore, doppio | 229 |
| Cavo, Pinze porta TITE GRP | 663 | COLLIN-LANDAU Speculi vaginali | 431 |
| Cerchiaggio, Strumenti | 660 | COLLIN ATRAUMATIC-GRIP Pinze da presa per intestino e tessuti | 389 |
| Cervello, Coltello | 40 | COLLIN Clamp ombelicale | 486 |
| Cervicale e prelievo, Pinza per la biopsia | 460 | COLLIN Dinamometro | 6 |
| Cervicale, Autofissatore per retrattori | 704 | COLLIN Divaricatori addominali | 297-298 |
| Cervice e uretra, Endospeculi | 443, 448 | COLLIN Divaricatori doppi | 227 |
| Cesioia con taglio frontale e laterale | 668 | COLLIN Martello | 617 |
| Cesioie | 668 | COLLIN Pinza da presa per intestino e tessuti | 386 |
| Cesioie per bendaggi e vestiti | 674 | COLLIN Pinza per afferrare l'utero | 458 |
| Cesioie per gessi | 676-678 | COLLIN Pinza per medicatura e tamponi | 207 |
| Cesioie per gessi DURACUT | 676 | COLLIN Pinza per togliere clips | 379 |
| Cesioie per ossa | 494, 637-639 | COLLIN Pinze tiralingua | 23 |
| Cesioie per vestiti e gessi | 675 | COLLIN Speculi vaginali | 431 |
| Cestelli in plastica per sterilizzazione | 742 | Collo vescicale, Dilatatore | 423 |
| Cestelli per spazzole | 753 | Colonna cervicale, Divaricatori | 285, 290-292 |
| Cestelli per spazzole e asciugamani | 753 | Colonna lombo vertebrale, Divaricatori | 294 |
| Cestelli per sterilizzazione | 739-741, 744-745 | Colonna vertebrale, Divaricatori | 288 |
| Cestelli per sterilizzazione e conservazione | 738 | Coltelli per amputazione | 38 |
| Cestelli rotondi per sterilizzazione | 743 | Coltelli per dura-madre | 37 |
| CHAMPY Strumento biopsia per trucioli dell'iliaco | 669 | Coltelli per resezione | 38 |
| CHAPUT Pinza da presa per intestino e tessuti | 383 | Coltello inter-osseo | 39 |
| CHARRIERE Seghe per amputazione e resezione | 572-573 | Coltello per autopsia | 40 |
| CHEATTLE Pinze per sterilizzazione | 734 | Coltello per falangi | 39 |
| CHERON Pinza per medicatura e tamponi | 207 | Coltello per gessi | 679 |
| CHEVALIER-JACKSON Cannule tracheali | 726 | Coltello per il cervello | 40 |
| CHEVALIER Divaricatore costale | 507 | Coltello per lobi | 39 |
| CHEYNE-WATSON Dissettori | 574 | Coltello per periostio con raschiatoio | 39 |
| Chiave per archi per trazione | 659 | Coltello per resezione e amputazione | 39 |
| Chiavi | 681 | Combinazione stetoscopica | 5 |
| CHILDE Pinze con porta clips | 378 | Compasso | 7 |
| CHILDE Pinze senza porta clips | 378 | Compresses, Pinze per fissare | 200-202 |
| Chiodi STEINMANN | 654 | Condotti biliari, Dilatatori | 415 |
| Chirurgia laser, Strumenti | 448-451 | Conduttrici, Sonde | 377-378 |
| Chirurgia lombo vertebrale, Speculi | 295 | CONE Pinze per ossa per cranio | 688 |
| Chirurgia plastica, Divaricatori | 26 | Conservazione e sterilizzazione, Cestelli | 738 |
| Chirurgia plastica, Forbici | 82 | Contenitore per micro-strumenti | 737 |
| Chirurgia plastica, Forbici DURACUT | 45 | Contenitore per spazzole usate | 753 |
| Chirurgia plastica, Uncino | 217-219 | CONTOUR SCALP Divaricatori autostatici | 276 |
| Chirurgia plastica, Uncino | 219 | CONVERSE GILLIES Divaricatori per pelle e dura-madre | 216 |
| Chirurgia rettale, Forbici DURACUT | 59 | CONVERSE TITE GRIP Portaghi | 342 |
| Chirurgia, Pinze | 144-148 | COOLEY-BECK ATRAUMATIC-GRIP Pinze per anastomosi | 560 |
| Chirurgia, Pinze a denti di topo | 118 | COOLEY-DERRA ATRAUMATIC-GRIP Pinze per anastomosi | 559 |
| Chirurgia, Pinze, fini | 138-143 | COOLEY-REYNOLDS ATRAUMATIC-GRIP Pinze per anastomosi | 559 |
| Ciglia, Pinze | 152 | COOLEY ATRAUMATIC-GRIP Clamp patent-ductus | 556 |
| Cilindri per siringhe | 330-331 | COOLEY ATRAUMATIC-GRIP Pinza Bulldog | 556 |
| Cilindri, Recipienti | 747 | COOLEY ATRAUMATIC-GRIP Pinza iliaca | 558 |
| Circoncisione, Strumento | 426 | COOLEY ATRAUMATIC-GRIP Pinza per aorta | 561 |
| CITELLI Pinze per laminectomia | 707 | COOLEY ATRAUMATIC-GRIP Pinza per l'aneurisma dell'aorta | 561 |
| Clamp-pinza a pressione | 409 | COOLEY ATRAUMATIC-GRIP Pinza per vasi periferici | 558 |
| Clamp-pinze per intestino e stomaco | 403 | COOLEY ATRAUMATIC-GRIP Pinze coartazione | 557 |
| Clamp ombelicali | 486 | COOLEY ATRAUMATIC-GRIP Pinze emostatiche per arterie renale | 558 |
| Clamp patent-ductus ATRAUMATIC-GRIP | 556 | COOLEY ATRAUMATIC-GRIP Pinze multiuso | 556, 562 |
| Clamp per appendicectomia e pinza schiaccia sperone | 403 | COOLEY ATRAUMATIC-GRIP Pinze per anastomosi | 560 |
| Clamp per intestino e stomaco con perno | 403 | COOLEY ATRAUMATIC-GRIP Pinze per occlusione tangenziale | 562 |
| Clamps-pinze per parametrio ATRAUMATIC-GRIP | 197 | COOLEY ATRAUMATIC-GRIP Pinze vascolari | 555 |
| Clamps-pinze per rene | 190 | COOLEY Dilatatori per l'aorta | 511 |
| Clamps-pinze per rene ATRAUMATIC-GRIP | 190 | COOLEY Dilatatori vascolari | 510 |
| Clamps Bulldog, Pinze metti-rimuovi TITAN-LINE | 160 | COOLEY Divaricatore per sternotomia | 499 |

| | |
|---|--------------|
| COOLEY Divaricatore per sternotomia in ALLUMINIO | 498 |
| COOLEY Divaricatori per cavità | 509 |
| COOLEY Tubo aspirazione | 327 |
| COOLEY Tubo aspirazione intracardiaca | 327 |
| COOLEY Tubo aspirazione vascolare | 327 |
| COOPER Aghi per legatura | 374 |
| Copertura verificata, Pinze | 152 |
| Cordone spermatico, Pinza per fissare | 425 |
| CORWIN-HEGAR TITE GRIP Pinza gira cavo | 662 |
| CORYLLOS Divaricatori e spatole per polmone | 261 |
| Costali, Approssimatori | 508 |
| Costali, Divaricatori | 503-508 |
| Costali, Divaricatori in ALLUMINIO | 500-502 |
| Costali, Periostotomi | 495, 497 |
| Costole e ossa, Pinze | 493 |
| Costole, Pinze | 494 |
| Costotomi | 492-493 |
| Cotone/spugne, porta | 473 |
| COTTLE-NEIVERT Uncino per narici posteriori | 221 |
| COTTLE DURACUT Forbici nasali | 58 |
| COTTLE Forbici nasali | 102 |
| COTTLE Martello | 620 |
| COTTLE Osteotomi | 608 |
| COTTLE Periostotomi | 583, 585 |
| COTTLE Raspa | 593 |
| COTTLE Uncino per chirurgia plastica, acuto | 218 |
| COTTLE Uncino per pelle e dura-madre | 217 |
| CRAFOORD-DE BAKEY ATRAUMATIC-GRIP Pinze per l'aneurisma dell'aorta con dentatura DE BAKEY | 546 |
| CRAFOORD-STILLE Pinza emostatica fine | 170 |
| CRAFOORD (STELZNER) Forbici per lobo polmonare e per il retto | 99 |
| CRAFOORD Pinza emostatica fine | 171 |
| CRAFOORD Pinze ventricolari | 564 |
| CRAIG-KOGLER Strumenti per biopsia vertebrale | 720-721 |
| Craniale, Alesatore per pinze di trazione | 689 |
| Craniale, Pinze per trazione | 689 |
| Cranio, Pinze per ossa | 688 |
| Cranio, Strumenti per l'apertura | 687 |
| Cranioclasto | 485 |
| CRILE-BABY Pinze emostatiche fini | 166 |
| CRILE-COLLER Pinze emostatiche fini | 167 |
| CRILE-MICRO Pinze emostatiche fini | 166 |
| CRILE-MURRAY Portaghi | 366 |
| CRILE-RANKIN-DE BAKEY ATRAUMATIC-GRIP Pinze emostatiche fini | 167 |
| CRILE-RANKIN (OCHSNER-DIXON) Pinze emostatiche fini | 167 |
| CRILE-RANKIN Pinze emostatiche fini | 167 |
| CRILE-WOOD Portaghi | 366, 368 |
| CRILE-WOOD TITE GRIP Portaghi | 341, 343 |
| CRILE Divaricatore, doppio | 227 |
| CRILE Portaghi | 371 |
| CRILE TITAN-LINE Pinze emostatiche fini | 166 |
| CRILE Uncini per nervi e vasi | 214 |
| CRUTCHFIELD Alesatore per pinze di trazione craniale | 689 |
| CRUTCHFIELD Pinze per trazione craniale | 689 |
| Cucchiai per calcoli biliari | 417 |
| Cucchiai per colecisti | 417 |
| Cucchiai per placenta e ovaie | 484 |
| Cucchiaio per lupus | 19 |
| Cucchiaio per medicinali | 751 |
| Culicola, Forbici | 16 |
| CULLEN-WERTHEIM Pinza per peduncoli renali | 191 |
| Cuoio capelluto, Graffe emostatiche | 691 |
| Cuoio capelluto, Pinza | 481 |
| Cura degli strumenti chirurgici, Liquido concentrato PREP LUBE | 733 |
| Curetta per secrezioni | 425 |
| Curette | 692 |
| Curette aspiranti per la biopsia dell'endometrio | 459 |
| Curette per aspirazione, Adattatore per la connessione | 471 |
| Curette per aspirazione | 470 |
| Curette per biopsia | 459-460 |
| Curette per la biopsia dell'endometrio | 459 |
| Curette per la biopsia endo-cervicale | 459-465 |
| Curette per ossa | 598-606 |
| Curette per placenta e ovaie | 484 |
| Curette per prelievo ed aspirazione | 471 |
| Curette taglianti | 606, 695-696 |
| Curette uterine | 466-470 |
| CURTIS Pinza per chirurgia | 147 |
| Curva/taglia, Tenaglie | 666 |

| | |
|--|----------|
| CUSCO Speculi vaginali | 430-431 |
| CUSHING-FERRIS-SMITH Pinze per laminectomia | 713 |
| CUSHING-LANDOLT Speculo per ipofidectomia transsfenoidale | 692 |
| CUSHING-TAYLOR Pinza anatomica per dissezione, fine | 131 |
| CUSHING-TAYLOR TITE GRIP Pinze anatomiche per dissezione | 114 |
| CUSHING-TAYLOR Pinza fine per chirurgia | 143 |
| CUSHING-TAYLOR Pinze auricolari e nasali | 136 |
| CUSHING Divaricatori per vene | 222-223 |
| CUSHING Gancio per decompressione | 701 |
| CUSHING Pinza fine per chirurgia | 142 |
| CUSHING Pinze anatomiche per dissezione, fini | 130 |
| CUSHING Pinze per laminectomia | 715 |
| CUSHING Punta | 652 |
| CUSHING Spatole cerebrali | 706 |
| CUSHING TITE GRIP Pinze anatomiche per dissezione | 114 |
| CUSHING Uncini per nervi e vasi | 214 |
| CUSHING Uncino per dura-madre, acuto | 218 |
| Cutaneo, Divaricatori | 216, 218 |
| Cutaneo, Uncino | 217 |
| Cuticola, Tronchesine | 17 |
| CUZZI Cucchiari per placenta e ovaie | 484 |
| CZERNY Pinza per abbassare il collo dell'utero | 455 |
| CZERNY Speculi rettali | 405 |

D

| | |
|---|---------|
| DAHLGREN Pinze per ossa per cranio | 688 |
| DALE ATRAUMATIC-GRIP Pinze per vasi periferici con dentatura DE BAKEY | 535 |
| DANDY Pinze emostatiche fini | 165 |
| DANDY Uncini per nervi e vasi | 214 |
| DARDIK ATRAUMATIC-GRIP Pinze multiuso | 554 |
| DARTIGUES Pinza per afferrare il rene | 421 |
| DAUBENSPECK Curette per ossa | 604 |
| DAVIDSON Divaricatori per scapola | 260 |
| DAVIS-RAGNELL Divaricatori per chirurgia plastica | 226 |
| DAVIS Spatole cerebrali | 706 |
| DAY Uncini auricolari | 213 |
| DE BAKEY-BAHNSON ATRAUMATIC-GRIP Pinze per l'aneurisma dell'aorta con dentatura DE BAKEY | 545 |
| DE BAKEY-BAINBRIDGE ATRAUMATIC-GRIP Pinze vascolari | 530 |
| DE BAKEY-BECK ATRAUMATIC-GRIP Pinze aorta | 537 |
| DE BAKEY-BECK ATRAUMATIC-GRIP Pinze per anastomosi | 543 |
| DE BAKEY-BECK ATRAUMATIC-GRIP Pinze per vena cava | 550 |
| DE BAKEY-CAROTIS ATRAUMATIC-GRIP Pinze Bulldog | 525 |
| DE BAKEY-CRAFOORD ATRAUMATIC-GRIP Pinze per l'aneurisma dell'aorta con dentatura DE BAKEY | 546 |
| DE BAKEY-CRILE-RANKIN Pinze emostatiche fini | 167 |
| DE BAKEY-DERRA ATRAUMATIC-GRIP Pinze per anastomosi | 542 |
| DE BAKEY-DIETRICH ATRAUMATIC-GRIP Pinze Bulldog | 526 |
| DE BAKEY-GLOVER ATRAUMATIC-GRIP Pinze Bulldog | 525 |
| DE BAKEY-GUYON ATRAUMATIC-GRIP Pinze clamps per rene | 190 |
| DE BAKEY-HALSTED-MOSQUITO Pinze emostatiche fini | 165 |
| DE BAKEY-HARKEN ATRAUMATIC-GRIP Pinze per dissezione e legature con dentatura DE BAKEY | 551 |
| DE BAKEY-HEANEY (ROGERS) ATRAUMATIC-GRIP Pinze per isterectomia | 197 |
| DE BAKEY-MORRIS ATRAUMATIC-GRIP Pinze per aorta | 540 |
| DE BAKEY-PEAN ATRAUMATIC-GRIP Pinze emostatiche | 176 |
| DE BAKEY-PEAN ATRAUMATIC-GRIP Pinze vascolari | 529 |
| DE BAKEY-POTTS ATRAUMATIC-GRIP Pinze patent-ductus | 531 |
| DE BAKEY-REYNOLDS ATRAUMATIC-GRIP Pinze per anastomosi | 542 |
| DE BAKEY-RUMEL ATRAUMATIC-GRIP Pinze per preparazioni e legature | 186 |
| DE BAKEY-SATINSKY ATRAUMATIC-GRIP Pinze Bulldog | 525 |
| DE BAKEY-WERTHEIM (ROGERS) ATRAUMATIC-GRIP Pinze-clamps per parametrio | 197 |
| DE BAKEY (GARRETT) Dilatatori vascolari | 510 |
| DE BAKEY ATRAUMATIC-GRIP Pinze vascolari | 135 |
| DE BAKEY ATRAUMATIC-GRIP Pinza emostatica per arteria renale | 537 |
| DE BAKEY ATRAUMATIC-GRIP Pinze Bulldog | 526 |
| DE BAKEY ATRAUMATIC-GRIP Pinze Bulldog | 528 |
| DE BAKEY ATRAUMATIC-GRIP Pinze multiuso | 553 |
| DE BAKEY ATRAUMATIC-GRIP Pinze patent-ductus | 531 |
| DE BAKEY ATRAUMATIC-GRIP Pinze per anastomosi | 543 |
| DE BAKEY ATRAUMATIC-GRIP Pinze per aorta | 539 |
| DE BAKEY ATRAUMATIC-GRIP Pinze per coartazione | 532-533 |
| DE BAKEY ATRAUMATIC-GRIP Pinze per dissezione e legature | 551 |

| | |
|--|-----------------------|
| DE BAKEY ATRAUMATIC-GRIP Pinze per l'aneurisma dell'aorta | 545 |
| DE BAKEY ATRAUMATIC-GRIP Pinze per l'aneurisma dell'aorta | 547 |
| DE BAKEY ATRAUMATIC-GRIP Pinze per vasi periferici | 534 |
| DE BAKEY ATRAUMATIC-GRIP Pinze per vasi periferici | 535-536 |
| DE BAKEY ATRAUMATIC-GRIP Pinze vascolari | 529 |
| DE BAKEY ATRAUMATIC-GRIP Pinze vascolari per occlusione tangenziale | 541 |
| DE BAKEY Divaricatori costali | 504-505 |
| DE BAKEY DURACUT Forbici vascolari | 57 |
| DE BAKEY Forbici per arteriotomia | 95 |
| DE BAKEY Forbici vascolari | 96 |
| DE BAKEY Pinza multiuso ATRAUMATIC-GRIP | 530 |
| DE BAKEY Pinze per tessuti e per aghi | 116 |
| DE BAKEY TITE GRIP Portaghi | 343 |
| DE BAKEY Tubo aspirazione | 325 |
| DE MARTEL-WOLFSON Pinze per anastomosi del colon | 402 |
| DE MARTEL-WOLFSON Portapinze | 402 |
| DE MARTEL-WOLFSON Serrapinze | 402 |
| DE MARTEL (BAILEY) Guida per fili per sega | 687 |
| DE VILBISS Pinze per ossa per cranio | 688 |
| DE VILBISS Speculo vaginale | 433 |
| DEAN DURACUT Forbici per gengiva | 55 |
| DEAN Forbici per tonsille | 103 |
| DEAVER-FORD Divaricatore e spatola per polmone | 263 |
| DEAVER Divaricatori e spatole per polmone | 264-265 |
| DEAVER Forbici per chirurgia | 71 |
| Decapitazione, Forbici | 109 |
| Decompressione, Ganci | 701 |
| DEJERINE Martelli percussori | 2 |
| DEMEL Guida cavo | 660 |
| DENHARDT Apribocca | 22 |
| DENIS-BROWNE Divaricatori addominali | 305 |
| DENKER-UECKERMANN Tre quarti per tracheotomia | 728 |
| Deponette | 738 |
| Depressori uterini | 447 |
| DERF Portaghi | 363 |
| DERF TITE GRIP Portaghi | 342 |
| Dermatici, Trapani | 20 |
| Dermatomi | 41-42 |
| DERRA-COLEY ATRAUMATIC-GRIP Pinze per anastomosi | 559 |
| DERRA-DE BAKEY ATRAUMATIC-GRIP Pinze per anastomosi | 542 |
| DESCHAMPS Aghi per legatura | 374-376 |
| DESJARDINS Dilatatori per condotti biliari | 415 |
| DESJARDINS Pinze per calcoli biliari | 419 |
| DESMARRES Divaricatori per vene | 222 |
| Dissezione, Forbici | 98 |
| Detergente per strumenti | 733 |
| Detroncazione, Uncino | 485 |
| DEUCHER Divaricatore addominale | 299 |
| DEVIN ATRAUMATIC-GRIP Pinze per la carotide con dentatura LAWTON | 524 |
| Diapason | 4 |
| DIEFFENBACH Pinze Bulldog | 163 |
| DIETRICH-DE BAKEY ATRAUMATIC-GRIP Pinze Bulldog | 526 |
| DIETRICH-HEGEMANN DURACUT Forbici vascolari | 56 |
| DIETRICH-HEGEMANN Forbici vascolari | 96 |
| DIETRICH ATRAUMATIC-GRIP Pinze per aorta con dentatura DE BAKEY | 539 |
| DIETRICH Forbici vascolari | 97 |
| DIETRICH TITE GRIP Micro-Portaghi | 339 |
| Dilatatore per coledoco | 416 |
| Dilatatore per collo vescicale | 423 |
| Dilatatore per tracheotomia | 728 |
| Dilatatore rettale con chiusura a scatto | 408 |
| Dilatatori e spatole intima | 512 |
| Dilatatori per condotti biliari | 415 |
| Dilatatori per l'ano ed il retto | 407-408 |
| Dilatatori per l'aorta | 511 |
| Dilatatori uterini | 443-445 |
| Dilatatrici candelette | 424 |
| Dinamometro | 6 |
| DINGMANN modif. Tenaglia per ossa | 624 |
| DINGMANN Tenaglia per ossa | 624 |
| Dischi di fissaggio | 659 |
| Dischi di fissaggio, Vite guida | 659 |
| Dispositivo di fissaggio | 309 |
| Dissettori | 574, 693-694, 696-700 |
| Dissettori per la dura-madre | 698-700 |
| Dissezione dei nervi, Forbici | 93 |
| Dissezione e legature, Pinze | 564 |
| Dissezione e legature, Pinze ATRAUMATIC-GRIP | 551 |
| Dissezione e tenotomia, Forbici fine | 92 |
| Dissezione, Forbici | 81, 84-91 |
| Dissezione, Forbici DURACUT | 47-53 |
| Dissezione, Forbici fine | 93 |
| Dissezione, Pinze anatomiche | 132-134 |
| Dissezione, Pinze anatomiche TITE GRIP | 112-115 |
| Dissezione, Pinze anatomiche, fini | 128-131 |
| Dissezione, Pinze con denti TITE GRIP | 117 |
| Distributore multiplo per punte filiformi | 657 |
| Distributore per punte filiformi | 656 |
| Distributori di spazzole | 752 |
| Dita, Divaricatore | 271 |
| Dita, Impugnatura a molla e piccolo divaricatore per ferite | 271 |
| DITTEL Catetere guida | 425 |
| Divaricatore (piccolo) per ferite e impugnatura a molla per dita | 271 |
| Divaricatore per dita | 271 |
| Divaricatore per gozzo | 224 |
| Divaricatore per la mano | 271 |
| Divaricatore per la mano e l'avambraccio | 271 |
| Divaricatore per laminectomia | 277, 279-280 |
| Divaricatore per piloro | 403 |
| Divaricatore per sternotomia | 499 |
| Divaricatore per sternotomia in ALLUMINIO | 498 |
| Divaricatore per trachea | 226 |
| Divaricatore per vene | 217, 222 |
| Divaricatore vescicale | 310 |
| Divaricatori | 212-310 |
| Divaricatori addominali | 297-306, 308-309 |
| Divaricatori addominali, Braccio laterale | 303 |
| Divaricatori autostatici | 270-276, 278, 282-283 |
| Divaricatori costali | 503-508 |
| Divaricatori costali in ALLUMINIO | 500-502 |
| Divaricatori cutaneo | 216, 218 |
| Divaricatori e divaricatori per ossa | 232 |
| Divaricatori e spatole per polmone | 261-265 |
| Divaricatori per appendicectomia | 284 |
| Divaricatori per cavità | 509 |
| Divaricatori per chirurgia plastica | 226 |
| Divaricatori per colonna cervicale | 285, 290-292 |
| Divaricatori per colonna lombo vertebrale | 294 |
| Divaricatori per colonna vertebrale | 288 |
| Divaricatori per emilaminectomia | 277 |
| Divaricatori per fegato | 255 |
| Divaricatori per guaina tendinea | 225 |
| Divaricatori per il torace | 507 |
| Divaricatori per interventi in profondità | 252-259 |
| Divaricatori per laminectomia | 284, 286 |
| Divaricatori per pelle e dura-madre | 216 |
| Divaricatori per pelvis | 256-258 |
| Divaricatori per polmone | 260 |
| Divaricatori per scapola | 260 |
| Divaricatori per tessuti molli | 241 |
| Divaricatori per vene | 222-223 |
| Divaricatori per vulva | 281 |
| Divaricatori spinali | 231 |
| Divaricatori vascolari | 510 |
| Divaricatori, doppi | 226-230 |
| Divaricatori, Ganci | 287 |
| Divaricatori per veni e hilus | 223 |
| Divaricatore per la tiroide | 243 |
| DIXON-LOVELACE Pinze emostatiche fini | 169 |
| DIXON-OCHSNER CRILE-RANKIN Pinze emostatiche fini | 167 |
| DOCKHORN Divaricatori | 245 |
| Doppia, Sonda | 694 |
| DOUGLAS-BOZEMANN Pinza per medicature | 208 |
| DOUGLAS Pinza per ciglia | 152 |
| DOUGLAS Tre quarti per puntura del seno mammellare | 320 |
| DOYEN-BABY ATRAUMATIC-GRIP Pinze intestinali | 391 |
| DOYEN-BABY Pinze intestinali | 391 |
| DOYEN-STILLE Divaricatori | 247 |
| DOYEN ATRAUMATIC-GRIP Pinze intestinali | 392-393 |
| DOYEN Divaricatori | 248-249 |
| DOYEN Forbici per pareti addominali | 106 |
| DOYEN Martelli | 618 |
| DOYEN Periototomi costali | 495 |
| DOYEN Pinza per fissare le compresse | 200 |
| DOYEN Pinza per polipi e ovaie | 457 |

| | |
|---|--------------|
| DOYEN Pinze intestinali | 392-393 |
| DOYEN Sonda scanalata | 314 |
| DOYEN Speculi e valve vaginali | 439 |
| DOYEN Succhielli per fibroma | 458 |
| DUBOIS Forbici per decapitazione | 109 |
| DUPLAY Pinza per abbassare il collo dell'utero | 453 |
| Dura-madre e pelle, Divaricatori | 216 |
| Dura-madre e pelle, Uncino | 217 |
| Dura-madre, Coltelli | 37 |
| Dura-madre, Dissettori | 698-700 |
| Dura-madre, Pinza guida sonda e protezione | 650 |
| Dura-madre, Uncini | 212, 217-218 |
| Dura madre, Forbici | 100 |
| DURACUT Cesoie per gessi | 676 |
| DURACUT Forbici | 44-60 |
| DURACUT Forbici adnex | 54 |
| DURACUT Forbici fini | 45 |
| DURACUT Forbici nasali | 58 |
| DURACUT Forbici per chirurgia | 46 |
| DURACUT Forbici per dissezione | 47-53 |
| DURACUT Forbici per episiotomia | 60 |
| DURACUT Forbici per gengiva | 55 |
| DURACUT Forbici per ginecologia | 60 |
| DURACUT Forbici per il setto nasale | 59 |
| DURACUT Forbici per iridectomia | 45 |
| DURACUT Forbici per la chirurgia rettale | 59 |
| DURACUT Forbici per legature | 353 |
| DURACUT Forbici taglia cavo | 665 |
| DURACUT Forbici uterine | 60 |
| DURACUT Forbici vascolari | 56-57 |
| DURACUT Parametrium forbici | 60 |
| DURACUT Tenaglie tagliafili | 667 |
| DURANTE Pinze vascolari e per tumori | 149 |
| DUVAL-COLLIN Pinza per intestino | 149 |
| DUVAL-COLLIN Pinze da presa per intestino e tessuti | 386 |
| DUVAL Pinza per intestino | 149 |
| DUVAL Pinze da presa per intestino e tessuti | 386-387 |
| DUVAL TITE GRIP Pinza da presa per intestino e tessuti | 388 |

E

| | |
|---|----------|
| EASTMAN-RICHARDSON Divaricatori | 250 |
| EATON-BECKMANN Divaricatore per laminectomia | 280 |
| ECHLIN Pinze per ossa | 634 |
| EDER Portacotone | 409 |
| EICKEN-KILLIAN Cannule per irrigazione del seno mascellare | 322 |
| EISELSBERG Forbici per legature | 352 |
| Elevatore per testa in interventi con taglio cesareo | 481 |
| Elevatori | 574-575 |
| Emilaminectomia, Divaricatori | 277 |
| EMMET Pinza per medicatura e tamponi | 207 |
| EMMET Uncino | 449 |
| EMMET Uncino per fistole | 221 |
| Emorroidi, Legatori con aspiratore | 411 |
| Emorroidi, Legatori con carica | 410 |
| Emorroidi, Pinze | 410 |
| Emostatica, Pinze per arteria renale ATRAUMATIC-GRIP | 537 |
| Emostatiche e tonsille, Pinze | 179 |
| Emostatiche, Pinze | 173-179 |
| Emostatiche, Pinze ATRAUMATIC-GRIP | 176 |
| Emostatiche, Pinze fini ATRAUMATIC-GRIP | 167 |
| Emostatiche, Pinze fini TITAN-LINE | 166 |
| Emostatiche, Pinze TITAN-LINE | 168 |
| Emostatici, Pinze fini | 164-173 |
| Empiema, Tre quarti | 318 |
| Enderectomia, Set | 515 |
| Enderectomia, Tiravene | 514 |
| Endo-cervicale, Curetta per la biopsia | 459-465 |
| Endometrio, Curetta aspirante per la biopsia | 459 |
| Endometrio, Curetta per la biopsia | 459 |
| Endospeculi | 443 |
| Endospeculi per cervice e uretra | 443, 448 |
| ENGEL Seghe per gessi | 679 |
| ENGL. MOD. Pinze per fissare le compresse | 200 |
| Enterotomia, Forbici | 109 |
| Enucleatore | 693 |
| Enucleatore per tendine | 646 |
| Episiotomia e perineo, Forbici | 107 |

| | |
|--|-----|
| Episiotomia, Forbici DURACUT | 60 |
| ERRICO Fresa | 652 |
| ESMARCH Cesoie per vestiti e gessi | 675 |
| ESMARCH Coltello per gessi | 679 |
| ESMARCH Fascia per ischemia | 570 |
| ESMARCH Tubo per ischemia | 570 |
| Espellere il tessuto campione, Otturatore smusso | 721 |
| Estensiometro | 4 |
| Estrarre il tessuto molle, Retrattore doppio | 721 |
| EUFRATE PASQUE TITE GRIP Portaghi | 344 |
| EWALD Pinze anatomiche per dissezione, fini | 129 |
| EWALD Pinze fini per chirurgia | 140 |

F

| | |
|---|--------------|
| FAHLBUSCH-HARDY Dissettori | 693 |
| Falangi, Coltello | 39 |
| FANSLER-IVES Anoscopi con otturatore di plastica | 407 |
| FARABEUF-ALEXANDER Periototomi costali | 497 |
| FARABEUF-COLLIN Periototomi | 588 |
| FARABEUF-LAMBOTTE Tenaglia per ossa | 626 |
| FARABEUF Divaricatori, doppi | 227 |
| FARABEUF Periototomi | 588 |
| FARRELL LATHBURY Portacotone | 316 |
| Fascia frontale | 10 |
| Fascia per ischemia | 570 |
| FAURE Pinze per peritoneo | 193 |
| FAVALORO Forbici per arteria coronaria | 95 |
| Fegato, Aghi per la puntura cieca | 329 |
| Fegato, Divaricatori | 255 |
| FEHLAND ATRAUMATIC-GRIP Pinze per anastomosi del retto | 401 |
| FEILCHENFELD Pinze per schegge | 150 |
| FEIN Portacotone | 317 |
| FERGUSON Aghi chirurgici per sutura | 356 |
| FERGUSON Forbici per chirurgia | 80 |
| FERGUSON FRAZIER Cannule per aspirazione con interruttore e stiletto | 323 |
| FERGUSON Tenaglia per ossa | 624 |
| Ferite e vescica, Siringhe | 331 |
| Ferite, Impugnatura a molla e piccolo divaricatore | 271 |
| FERRIS-SMITH-CUSHING Pinze per laminectomia | 713 |
| FERRIS-SMITH-KERRISON Pinze per laminectomia | 709-710, 712 |
| FERRIS-SMITH Pinze per chirurgia | 147 |
| Fibroma, Succhielli | 458 |
| Fili per sega | 687 |
| Fili per sega, Guida | 687 |
| Fili per sega, Manico ad uncino | 687 |
| Filo di argento | 690 |
| Filo per ossa | 660 |
| FINOCHIETTO-BABY-HAIGHT Divaricatori costali in ALLUMINIO | 501 |
| FINOCHIETTO-BABY Divaricatori costali | 503 |
| FINOCHIETTO-BURFORD Divaricatori costali | 503 |
| FINOCHIETTO-BURFORD Divaricatori costali in ALLUMINIO | 502 |
| FINOCHIETTO-INFANT Divaricatori costali in ALLUMINIO | 501 |
| FINOCHIETTO-RIENHOFF Divaricatori costali | 506 |
| FINOCHIETTO Divaricatori costali | 503 |
| FINOCHIETTO Divaricatori costali in ALLUMINIO | 501 |
| FINOCHIETTO modif. Divaricatori costali in ALLUMINIO | 500 |
| FINOCHIETTO Pinza per torace e legature | 564 |
| FINOCHIETTO Portaghi | 369 |
| FINOCHIETTO TITE GRIP Portaghi | 346 |
| FINSEN Divaricatori autostatici | 270 |
| FISCH Uncino per dura-madre | 212 |
| FISCHER Eucleatore per tendine | 646 |
| Fistole e vascolare, Forbici DURACUT | 45 |
| Fistole, Bisturi | 37 |
| Fistole, Sonde | 314, 409 |
| Fistole, Uncini | 221 |
| FLETCHER (JAVERTS) Pinza per tamponi e spugne | 210 |
| FLUHRER Sonde bottonute | 313 |
| FOERSTER-BALLENGER Pinze per tamponi e spugne | 209 |
| FOERSTER Divaricatore addominale | 308 |
| FOERSTER FORBES Pinza per tamponi e spugne | 210 |
| FOERSTER Valve in NYLON per divaricatori addominali | 308 |
| FOMON DURACUT Forbici nasali | 58 |
| FOMON Forbici con aletta nasale | 81 |
| FOMON Forbici nasali | 102 |
| FOMON Forbici per la chirurgia plastica | 82 |

| | |
|---|---------------|
| FOMON Taglio di lima / taglio di raspa | 595 |
| FOMON TITE GRIP Raspe | 597 |
| FOMON Uncino per narici posteriori | 221 |
| FORBES (FOERSTER) Pinza per tamponi e spugne | 210 |
| Forbici-micro | 62-67 |
| Forbici con aletta nasale | 81 |
| Forbici con portaghi | 370 |
| Forbici da utero | 104-106 |
| Forbici DURACUT | 44-66 |
| Forbici fine per chirurgia | 68-70 |
| Forbici fine per dissezione | 93 |
| Forbici fine per dissezione e per tenotomia | 92 |
| Forbici fini DURACUT | 45 |
| Forbici nasali | 101-102 |
| Forbici nasali DURACUT | 58 |
| Forbici ombelicali | 108 |
| Forbici per arteria coronaria | 95 |
| Forbici per arteriotomia | 95 |
| Forbici per bendaggi | 672-673 |
| Forbici per chirurgia | 71-84 |
| Forbici per chirurgia DURACUT | 46 |
| Forbici per chirurgia e per dissezione | 82 |
| Forbici per decapitazione | 109 |
| Forbici per dissezione | 81, 84-91, 98 |
| Forbici per dissezione, DURACUT | 47-53 |
| Forbici per dura madre | 100 |
| Forbici per enterotomia | 109 |
| Forbici per episiotomia DURACUT | 60 |
| Forbici per fissurare le unghie | 81 |
| Forbici per gengiva | 94 |
| Forbici per gengiva DURACUT | 55 |
| Forbici per ginecologia DURACUT | 60 |
| Forbici per il setto nasale | 102 |
| Forbici per il setto nasale DURACUT | 59 |
| Forbici per la cartilagine | 82 |
| Forbici per la chirurgia plastica | 82 |
| Forbici per la chirurgia plastica DURACUT | 45 |
| Forbici per la cuticola | 16 |
| Forbici per la dissezione dei nervi | 93 |
| Forbici per legature | 352-353 |
| Forbici per legature, DURACUT | 353 |
| Forbici per lobo polmonare e per il retto | 99 |
| Forbici per nervo trigemino | 100 |
| Forbici per neurochirurgia | 100 |
| Forbici per parametrium DURACUT | 60 |
| Forbici per pareti addominali | 106 |
| Forbici per perineo (episiotomia) | 107 |
| Forbici per tonsille | 103 |
| Forbici per unghie | 16 |
| Forbici per vena cava | 99 |
| Forbici per vene | 63 |
| Forbici taglia cavo | 665 |
| Forbici taglia cavo DURACUT | 665 |
| Forbici uterine DURACUT | 60 |
| Forbici vascolari | 95-98 |
| Forbici vascolari DURACUT | 56-57 |
| Forbici vascolari e per fistole DURACUT | 45 |
| Forchetta da sutura | 378 |
| Forchetta per impiantare | 693 |
| Forcipi | 478-480 |
| Forcipi per tagli cesarei | 480 |
| FORD-DEAVER Divaricatore e spatola per polmone | 263 |
| FOSS Divaricatore e spatola per polmone | 263 |
| FOX-GOLDMANN DURACUT Forbici per gengiva | 55 |
| FOX-GOLDMANN Forbici per gengiva | 94 |
| FOX Raschiatoio per lupus | 20 |
| FRAIZER Divaricatore per pelle e dura-madre | 216 |
| FRANZ Divaricatori addominali | 304 |
| FRAZIER (FERGUSON) Cannule per aspirazione con interruttore e stiletto | 323 |
| FRAZIER Cannule per aspirazione con interruttore e stiletto | 323 |
| FRAZIER Dissettore per la dura-madre | 698 |
| FREER Divaricatore | 218 |
| FREER Periostotomi | 583 |
| FREER Scalpelli | 607 |
| FRENCH EYE TITE GRIP Portaghi | 340 |
| FRENZEL Abbassalingua | 12 |
| Fresa | 652 |
| FRIEDMAN-LUER Pinza per ossa | 631 |

| | |
|--------------------------------|-----|
| FRITSCH Divaricatori | 250 |
| FROHN Portacotone | 316 |
| FRYKHOLM Pinze per ossa | 635 |

G

| | |
|--|---------|
| Galea, Ganci | 691 |
| GALLAHER Raspa | 592 |
| Ganci di trazione | 659 |
| Ganci galea | 691 |
| Ganci per decompressione | 701 |
| Gancio per divaricatori | 287 |
| GANSKE-BIRCHER Pinze da presa per menisco e cartilagine | 640 |
| GARRETT (DE BAKEY) Dilatatori vascolari | 510 |
| Gastro-intestinale, Apparecchiatura di sutura | 404 |
| Gastro-intestinale, Graffe per sutura | 404 |
| GAYLOR-THOMS Pinza per la biopsia cervicale e da prelievo | 460 |
| GEISSENDOERFER-OVERHOLT Pinze per preparazioni e legature | 184 |
| GELPI-BABY Divaricatori per vulva | 281 |
| GELPI-SELETZ Divaricatore per vulva | 281 |
| GELPI Divaricatori per vulva | 281 |
| GEMINI-MIXTER Pinze per preparazioni e legature | 181 |
| GEMINI Pinze per preparazioni e legature | 181 |
| Gengiva, Forbici | 94 |
| Gengiva, Forbici DURACUT | 55 |
| GERALD Pinza per dissezione con denti | 117 |
| GERALD Pinze anatomiche per dissezione, fini | 130 |
| GERALD Pinze fini per chirurgia | 142 |
| GERALD TITE GRIP Pinza anatomica per dissezione | 114 |
| GERSTER Tenaglia per ossa | 630 |
| GERZOG Martello | 618 |
| Gessi e vestiti, Cesioie | 675 |
| Gessi, Cesioie | 676-678 |
| Gessi, Cesioie DURACUT | 676 |
| Gessi, Coltello | 679 |
| Gessi, Seghe | 679 |
| Gesso, Apri | 682 |
| Gesso, Rompi | 682 |
| GIBBON-BAILEY Approssimatori costali | 508 |
| GIERTZ-STILLE Costotomo | 492 |
| GIGLI (OLIVECRONA) Fili per sega | 687 |
| GIGLI Manico ad uncino per fili per sega | 687 |
| GIL-VERNET MARBERGER Divaricatori per veni e hilus | 223 |
| GILLIES-BABY Portaghi con forbici | 370 |
| GILLIES-BABY TITE GRIP Portaghi | 348 |
| GILLIES (CONVERSE) Divaricatori per pelle e dura-madre | 216 |
| GILLIES Divaricatore cutaneo | 216 |
| GILLIES Pinza fine per chirurgia | 142 |
| GILLIES Pinza per dissezione con denti | 117 |
| GILLIES Portaghi con forbici | 370 |
| GILLIES TITE GRIP Portaghi | 348 |
| Ginecologia, Forbici DURACUT | 60 |
| Ginocchio, Retrattori | 641 |
| Giunto a sfera ad incastro | 705 |
| Giunto a sfera, Porta asta per fissaggio | 705 |
| GLASSMANN (KILNER) Forbici | 83 |
| GLOVER-DE BAKEY ATRAUMATIC-GRIP Pinze Bulldog | 525 |
| GLOVER ATRAUMATIC-GRIP Pinze per anastomosi con dentatura DE BAKEY | 544 |
| GLUCK Costotomo | 492 |
| GOLET Divaricatore, doppio | 229 |
| GOLDMANN-FOX DURACUT Forbici per gengiva | 55 |
| GOLDMANN-FOX Forbici per gengiva | 94 |
| Goniometro per le membra | 7 |
| GOOD Forbici per tonsille | 103 |
| GOODELL Dilatatore uterino | 443 |
| GORNEY DURACUT Forbici per il setto nasale | 59 |
| GORNEY Forbici per la chirurgia plastica | 82 |
| GOSSET-BABY Divaricatore addominale | 299 |
| GOSSET Divaricatore addominale | 299-300 |
| GOURDET Curette uterine | 466 |
| Gozzo, Divaricatore | 224 |
| Gozzo, Sonda | 378 |
| Graduati, Misurini | 751 |
| GRAEFE (TYRELL) Divaricatori cutaneo | 216 |
| GRAEFE Pinza per chirurgia | 148 |
| GRAEFE Pinze anatomiche per dissezione, fini | 128 |
| GRAEFE Pinze fini per chirurgia | 139 |
| GRAEFE Uncini per strabismo | 213 |

| | |
|---|---------|
| Graffe | 379 |
| Graffe di argento | 690 |
| Graffe emostatici per cuoio capelluto | 691 |
| Graffe in argento per sutura gastro-intestinale | 404 |
| Graffe, Pinza metti | 690 |
| Graffe, Pinza per applicare e togliere | 691 |
| GRAHAM Uncino per dura-madre | 217 |
| GRAMCKO-BUCK Leve per ossa | 576 |
| GRAVE modif. Speculo vaginale | 432 |
| GRAVE Speculi vaginali | 432-433 |
| GREEN-ARMYTAGE Pinza emostatica per tagli cesarei | 481 |
| GREEN-SENN Divaricatori | 224 |
| GREEN Divaricatore per la tiroide | 243 |
| GREEN Pinza per fissare le compresse | 200 |
| GREGORY-SOFT Pinze per la carotide ATRAUMATIC-GRIP | 527 |
| GREGORY Pinza per profondità ATRAUMATIC-GRIP | 534 |
| GRONINGEN Uncini per nervi e vasi | 215 |
| GROSS Pinze per medicatura e tamponi | 204 |
| GRUENWALD-LOVE Pinze per laminectomia | 716 |
| GRUENWALD (JANSEN) Pinze auricolari e nasali | 136 |
| GRUENWALD Pinze auricolari e nasali | 136 |
| Guaina tendinea, Divaricatori | 225 |
| Guida ago a tromba | 486 |
| Guida cavo | 660 |
| Guida e scanalare, Strumento | 646 |
| Guida per fili per sega | 687 |
| Guida per legatura, bottonuta | 697 |
| Guida per tendine | 646 |
| Guida sonda e per la protezione della dura-madre, Pinza | 650 |
| GUNNAR-HEY Pinza pressa tubi con rulli | 203 |
| GUTHRIE Divaricatore | 218 |
| GUYON-DE BAKEY ATRAUMATIC-GRIP Pinze-clamps per rene | 190 |
| GUYON Catetere guida | 425 |
| GUYON Pinze-clamps per rene | 190 |
| GUYON Strumento per introdurre cateteri o sonde | 425 |

H

| | |
|--|----------|
| HABERE Spatola addominale e intestinale | 267 |
| HAETH-RICHTER Pinza per togliere clips | 379 |
| HAIGHT-FINOCCHIETTO-BABY Divaricatori costali in ALLUMINIO | 501 |
| HAIGHT Divaricatori costali | 506 |
| HAJEK-KOFLER Pinze per laminectomia | 708 |
| HAJEK Martelli | 617 |
| HALLE Coltello per dura-madre | 37 |
| HALLE Curette per ossa | 604 |
| HALLE Periostotomo | 582 |
| HALLE Spatola intima | 512 |
| HALSEY Portaghi | 363 |
| HALSEY TITE GRIP Portaghi | 341-342 |
| HALSTED-MICRO Pinze emostatiche fini | 164 |
| HALSTED-MOSQUITO-DE BAKEY Pinze emostatiche fini | 165 |
| HALSTED-MOSQUITO (HEISS) Pinze emostatiche fini | 170 |
| HALSTED-MOSQUITO Pinze emostatiche fini | 164-165 |
| HALSTED Pinze emostatiche fini | 169, 171 |
| HARDY-FAHLBUSCH Dissettori | 693 |
| HARDY Curette | 692 |
| HARDY Dissettori | 693 |
| HARDY Enuclatore | 693 |
| HARDY Forchetta per impiantare | 693 |
| HARKEN-DE BAKEY ATRAUMATIC-GRIP Pinze per dissezione e legature con dentatura DE BAKEY | 551 |
| HARRINGTON-MAYO Forbici per dissezione | 86 |
| HARRINGTON Divaricatori e spatole per polmone | 262 |
| HARTMAN (MOSQUITO-BABY) Pinze emostatiche fini | 501 |
| HARTMANN-COLLIN Divaricatore, doppio | 229 |
| HARTMANN Diapason | 4 |
| HARTMANN Pinze per la biopsia cervicale e da prelievo | 462 |
| HARTMANN Sonda auricolare | 322 |
| HASSELLTINE Pinze ombelicali | 486 |
| HAVERFIELD-SCOVILLE Divaricatore per laminectomia | 286 |
| HAYES ATRAUMATIC-GRIP Pinze per anastomosi del retto | 400 |
| HEANEY-BALLENTINE Pinza per isterectomia | 196 |
| HEANEY-DE BAKEY (ROGERS) ATRAUMATIC-GRIP Pinze per isterectomia | 197 |
| HEANEY-REZEK Pinza per isterectomia | 196 |
| HEANEY-SIMON Divaricatori per interventi in profondità | 254 |
| HEANEY Pinze per chirurgia | 147 |

| | |
|--|----------|
| HEANEY Pinze per isterectomia | 196 |
| HEANEY Portaghi | 369 |
| HEANEY TITE GRIP Portaghi | 346 |
| HEATH Martello | 620 |
| HEGAR-BABY-OLSEN TITE GRIP Portaghi | 348 |
| HEGAR-BAUMGARTNER TITE GRIP Portaghi | 342 |
| HEGAR-CORWIN TITE GRIP Pinza gira cavo | 662 |
| HEGAR-MAYO Portaghi | 367 |
| HEGAR-MAYO TITE GRIP Portaghi | 341, 345 |
| HEGAR-OLSEN Portaghi con forbici | 370 |
| HEGAR-OLSEN TITE GRIP Portaghi | 348 |
| HEGAR Dilatatori uterini | 444-445 |
| HEGEMANN-DIETRICH DURACUT Forbici vascolari | 56 |
| HEGEMANN-DIETRICH Forbici vascolari | 96 |
| HEGENBARTH Pinza per mettere clips | 379 |
| HEIFETZ Pinze per afferare tessuti e tumori, a baionetta | 127 |
| HEIFETZ Spatole cerebrali | 706 |
| HEISS (HALSTED-MOSQUITO) Pinze emostatiche fini | 170 |
| HEISTER Apribocca | 22 |
| HEMINGWAY Curette per ossa | 599 |
| HENLEY Divaricatori autostatici | 282-283 |
| HENNIG Apri gesso | 682 |
| HERRICK Pinza per peduncoli renali | 191 |
| HEY-GUNNAR Pinza pressa tubi con rulli | 203 |
| HEYMANN DURACUT Forbici nasali | 58 |
| HEYMANN Forbici nasali | 101 |
| HEYWOOD-SMITH Pinza per polipi e ovaie | 457 |
| HEYWOOD-SMITH Pinze tirilingua | 23 |
| HIBBS Divaricatori | 231 |
| HIBBS Divaricatori spinali | 231 |
| Hilus e veni, Divaricatori | 223 |
| HIRSCHMANN Anoscopi | 407 |
| HOEN Periostotomi | 586 |
| HOGLUND-LOWMAN Tenaglie per ossa | 630 |
| HOHMANN-ALDINGER Leve per ossa | 580 |
| HOHMANN-LANGE Leve per ossa | 577 |
| HOHMANN-LANGE modif. Leve per ossa | 577 |
| HOHMANN-MINI Leve per ossa | 576 |
| HOHMANN Leve per ossa | 578-580 |
| HOKE Osteotomi | 607 |
| HOLSHER Separatore per la radici dei nervi | 701 |
| HOPKINS-JOHNS Pinza per applicare e rimuovere clamps | 527 |
| HOPKINS-JOHNS Pinze Bulldog | 163 |
| HOPKINS Coltelli per gessi | 679 |
| HORGAN Valva centrale per divaricatori addominali | 303 |
| HORNE-JOBSON Portacotone | 317 |
| HORSLEY-LISTON-KEY Cesiole per ossa | 494 |
| HORSLEY Dissetto per la dura-madre | 698 |
| HÖSEL Divaricatori | 246 |
| HOSPITAL-PROVIDENCE Pinze emostatiche fini | 168 |
| HOUSE Curette per ossa | 598 |
| HOWARD Periostotomo | 583 |
| HOZBACH Pinze per isterectomia | 194 |
| HRYNTSCHAK-YOUNG Portaghi a boomerang con 1 ago | 372 |
| HUDSON Trapano a mano per ossa | 652 |
| HULKA-KENWICK Pinza per abbassare il collo dell'utero | 453 |
| HULKA Pinza per abbassare il collo dell'utero | 453 |
| HUMBY Dermatomo | 42 |
| HUNTER Pinze per schegge | 150 |
| HURD Aghi per legatura | 374 |

I

| | |
|--|---------|
| Idrocele e puntura addominale, Tre quarti | 318 |
| Iliaca, Pinza ATRAUMATIC-GRIP | 558 |
| Illuminatore prossimale per amnioscopio a luce calda con lampada | 472 |
| Illuminatore prossimale per amnioscopio a luce fredda | 472 |
| Imbuti | 751 |
| Impiantare, Forchetta | 693 |
| Impugnatura a molla per dita e piccolo divaricatore per ferite | 271 |
| INFANT-FINOCCHIETTO Divaricatori costali in ALLUMINIO | 501 |
| Infermeria, Articoli | 751 |
| Infermiera, Set | 18 |
| INGE Separatori per vertebre | 296 |
| Iniezione, Ago | 486 |
| Insulina, Siringhe | 330 |
| Inter-osseo, Coltello | 39 |
| Interventi in profondità, Divaricatori | 252-259 |

| | |
|---|------------------|
| Intestinale, Aghi per sutura | 354 |
| Intestinale-gastro, Apparecchiatura di sutura | 404 |
| Intestinale-gastro, Graffe per sutura | 404 |
| Intestinali e addominali, Spatole | 266-267 |
| Intestinali, Anastomosi, Pinze | 402 |
| Intestinali, Pinze | 390-396 |
| Intestinali, Pinze ATRAUMATIC-GRIP | 391-393, 395-396 |
| Intestino e stomaco, Clamp-pinze | 403 |
| Intestino e stomaco, Clamp con perno | 403 |
| Intestino e tessuti, Pinze da presa | 383-389 |
| Intestino e tessuti, Pinze da presa ATRAUMATIC-GRIP | 389 |
| Intestino e tessuti, Pinze da presa TITE GRIP | 388 |
| Intestino, Pinze | 149 |
| Intima, Bisturi | 513 |
| Intima, Spatole | 512-513 |
| Intima, Spatole e dilatatori | 512 |
| Intra-uterina, Pinza | 447 |
| Introduzione, Aghi | 334 |
| IOWA Ago per iniezione | 486 |
| IOWA Guida ago a tromba | 486 |
| IOWA Pinza per puntura amniotica | 477 |
| Ipfisectomia transsfenoidale, Speculo | 692 |
| Ipfis, Strumenti | 692-693 |
| Iridectomie, Forbici DURACUT | 45 |
| Irrigatori | 751 |
| Ischemia, Fascia | 570 |
| Ischemia, Tubo | 570 |
| ISRAEL Divaricatori | 237 |
| Isterectomia, Pinze | 194-196 |
| Isterectomia, Pinze ATRAUMATIC-GRIP | 197 |
| Isterometri | 446 |
| Isterosalpingografia, Strumentario | 474 |
| IVES-FANSLER Anoscopi con otturatore di plàstico | 407 |

J

| | |
|--|----------|
| JACKSON-CHEVALIER Cannule tracheali | 726 |
| JACKSON Divaricatore per trachea | 226 |
| JACKSON Pinza per la presa del tendine | 647 |
| JACKSON Speculi vaginali | 438 |
| JACKSON Uncino tracheale | 217 |
| JACOBS Pinza per abbassare il collo dell'utero | 456 |
| JACOBSON Micro portaghi | 359 |
| JACOBSON Bisturi per vasi | 694-695 |
| JACOBSON Micro-forbici | 64 |
| JACOBSON Punzone per sutura | 694 |
| JACOBSON Sonda bottonuta | 694 |
| JACOBSON Sonda doppia | 694 |
| JACOBSON TITE GRIP Micro-Portaghi | 338 |
| JAMESON Forbici fine per dissezione | 93 |
| JAMESON Portaghi | 368 |
| JANSEN-ZAUFAL Pinza per ossa | 633 |
| JANSEN (GRUENWALD) Pinze auricolari e nasali | 136 |
| JANSEN Curette per ossa | 599 |
| JANSEN Divaricatori autostatici | 272 |
| JANSEN Lampada | 11 |
| JANSEN Periostotomo | 587 |
| JANSEN Pinze auricolari e nasali | 136 |
| JANSEN Pinze per ossa | 632 |
| JAVERTS FLETCHER Pinza per tamponi e spugne | 210 |
| JAVID ATRAUMATIC-GRIP Pinze per carotide | 537 |
| JOBSON-HORNE Portacotone | 317 |
| JOHNS-HOPKINS Pinza per applicare e rimuovere clamps | 527 |
| JOHNS-HOPKINS Pinze Bulldog | 163 |
| JONES-LELAND Pinze per vasi periferici ATRAUMATIC-GRIP | 534 |
| JONES Pinze per fissare le compresse | 200 |
| JORGENSON Forbici per dissezione | 98 |
| JOSEPH Bisturi per rinoplastica | 37 |
| JOSEPH DURACUT Forbici per la chirurgia plastica | 45 |
| JOSEPH Forbici fine per chirurgia | 70 |
| JOSEPH Lima per ossa | 592 |
| JOSEPH Periostotomo | 582 |
| JOSEPH Uncini per chirurgia plastica | 217, 219 |
| JUDD-ALLIS Pinza da presa per intestino e tessuti | 384 |
| JUDD-MASSON Divaricatore vescicale | 310 |

K

| | |
|--|--------------------|
| KADER Spatole addominali e intestinali | 267 |
| KALLMORGEN Speculi e valve vaginali | 434 |
| KALT Aghi per sutura vascolare | 354 |
| KALT Portaghi | 363 |
| KATSCH Tiracomedoni | 19 |
| KAY-LAMBERT ATRAUMATIC-GRIP Pinze per anastomosi dell'aorta | 549 |
| KAZANJIAN Cesoie per ossa | 637 |
| KELLY-BABY Pinze emostatiche fini | 168 |
| KELLY-RANKIN Pinze emostatiche fini | 169 |
| KELLY Divaricatori | 251 |
| KELLY Divaricatori per interventi in profondità | 255 |
| KELLY DURACUT Forbici vascolari e per fistole | 45 |
| KELLY Forbici per chirurgia | 80 |
| KELLY Pinza per polipi e ovaie | 457 |
| KELLY Pinze emostatiche fini | 168 |
| KELLY Pinze emostatiche fini TITAN-LINE | 168 |
| KELLY Sfinteroscopi | 407 |
| KENWICK-HULKA Pinza per abbassare il collo dell'utero | 453 |
| KERN-LANE Tenaglia per ossa | 625 |
| KERN-MINI Tenaglia per ossa | 625 |
| KERRISON-FERRIS-SMITH Pinze per laminectomia | 709-710, 712 |
| KERRISON-LOVE (COLCLOUGH) Pinze per laminectomia | 710-711 |
| KERRISON Pinze per laminectomia | 707 |
| KEVOURKIAN-PACIFIC Pinza per la biopsia cervicale e da prelievo | 464 |
| KEVOURKIAN-YOUNGE Curette per la biopsia endo-cervicale | 459 |
| KEVOURKIAN-YOUNGE Pinze per la biopsia cervicale e da prelievo | 463,465 |
| KEY-HORSLEY-LISTON Cesoie per ossa | 494 |
| KEY Periostotomi | 589 |
| KEYES Strumentario per trapanazione della cute | 20 |
| KEYES Trapani dermatici | 20 |
| KIELAND-LUIKART Forcipi | 479 |
| KIELAND Forcipi | 479 |
| KILLIAN-EICKEN Cannule per irrigazione del seno mascellare | 322 |
| KILLIAN (MÜHLING) Forbici per il setto nasale | 102 |
| KILLIAN Periostotomi | 583 |
| KILNER (GLASSMANN) Forbici | 83 |
| KILNER Divaricatore cutaneo | 216 |
| KILNER Forbici fine per dissezione | 93 |
| KILNER TITE GRIP Portaghi | 342 |
| KIRK Martello | 618 |
| KIRKLIN Divaricatori per vene | 223 |
| KIRSCHNER-BALFOUR Valva per divaricatori addominali | 307 |
| KIRSCHNER Archi per trazione | 658-659 |
| KIRSCHNER Divaricatori addominali | 306 |
| KIRSCHNER Punta filiformi | 655 |
| KIRSCHNER Sonde conduttrici | 377 |
| KIRSCHNER Valve per divaricatori addominali | 307 |
| KLAPP Divaricatori per guaina tendinea | 225 |
| KLEINERT-KUTZ Pinza passa tendine | 649 |
| KLEINSCHMIDT Pinza schiaccia sperone e clamp per appendicectomia | 403 |
| KLIMA-ROSEGGER Aghi per la puntura dello sterno | 329, 518 |
| KLINGENBERG-LOTH Forbici per dissezione | 98 |
| KNAPP Divaricatore | 218 |
| KNAPP Forbici fine per chirurgia | 68 |
| KNIGHT DURACUT Forbici nasali | 58 |
| KNIGHT Forbici nasali | 101 |
| KNOWLES Forbici per bendaggi | 673 |
| KNUTSON Strumento per ureterografia | 426 |
| KOCHER-BABY ATRAUMATIC-GRIP Pinze intestinali | 391 |
| KOCHER-BABY Pinze intestinali | 391 |
| KOCHER-LANGENBECK Divaricatori | 240 |
| KOCHER-OCHSNER Pinze emostatiche | 177 |
| KOCHER ATRAUMATIC-GRIP Pinza intestinali | 395 |
| KOCHER Divaricatori | 232, 235, 242, 244 |
| KOCHER Pinze emostatiche | 176 |
| KOCHER Pinze intestinali | 392-394 |
| KOCHER Sonda per gozzo | 378 |
| KOCHER Spatola vescicale | 268 |
| KOENIG Sonde conduttrici | 377 |
| KOERTE-LUER Cucchiari per calcoli biliari | 417 |
| KOERTE Divaricatori | 236 |
| KOFLER-HAJEK Pinze per laminectomia | 708 |
| KOGAN Endospeculi per cervice e uretra | 443, 448 |
| KÖLN MOD. Graffe emostatiche per cuoio capelluto | 691 |
| KÖNIG-ROSER Apribocca | 22 |

| | |
|---|---------|
| KÖNIG Periostotomo | 582 |
| KONRICH Cestelli rotondi per sterilizzazione | 743 |
| KOOS Bisturi per vasi | 695 |
| KRAUS Bisturi per vasi | 695 |
| KRAUSE Tre quarti per puntura del seno mascellare | 319 |
| KRAYENBÜHL Uncini per nervi e vasi | 215 |
| KRISTELLER Speculi e valve vaginali | 434-437 |
| KROENLEIN Pinza emostatica | 173 |
| KRONECKER Aghi per legatura | 374 |
| KÜHNE Pinza con copertura vetrificata | 152 |
| KUTZ-KLEINERT Pinza passa tendine | 649 |

L

| | |
|--|------------------------|
| LA GRANGE Forbici per gengiva | 94 |
| LABORDE Dilatatore per tracheotomia | 728 |
| LAHEY-SWEET Pinza per preparazioni e legature | 189 |
| LAHEY Divaricatore | 219 |
| LAHEY Divaricatore per gozzo | 224 |
| LAHEY Pinze per abbassare il collo dell'utero | 454 |
| LAHEY Pinze per preparazioni e legature | 189 |
| LAMBERT-KAY ATRAUMATIC-GRIP Pinze per anastomosi dell'aorta | 549 |
| LAMBERT-LOWMAN Tenaglia per ossa | 630 |
| LAMBOTTE-FARABEUF Tenaglia per ossa | 626 |
| LAMBOTTE-MINI Osteotomi | 608 |
| LAMBOTTE Osteotomi | 608 |
| LAMBOTTE Periostotomi costali | 497 |
| LAMBOTTE Tenaglie per ossa | 626-627 |
| Lame a scalpello intercambiabili | 611 |
| Lame a sgorbia intercambiabili | 611 |
| Lame di ricambio | 681 |
| Lame intercambiabili manico, con chiave | 611 |
| Lame intercambiabili per osteotomo | 611 |
| Lame per bisturi, sterili | 34-35 |
| Lamette | 36 |
| Laminectomia, Divaricatori | 277, 279-280, 284, 286 |
| Laminectomia, Pinze | 707-719 |
| Lampada di ricambio | 472 |
| Lampade frontali | 11 |
| LANDAU-COLLIN Speculi vaginali | 431 |
| LANDAU Speculi vaginali | 440 |
| LANDOLT-CUSHING Speculo per ipofisectomia transsfenoidale | 692 |
| LANDOLT Periostotomo | 585 |
| LANE-KERN Tenaglia per ossa | 625 |
| LANE-MURPHY Leve per lussazione | 581 |
| LANE Pinza per fissare le compresse | 201 |
| LANE Tenaglia per ossa | 625 |
| LANGE-HOHMANN Leve per ossa | 577 |
| LANGE-HOHMANN modif. Leve per ossa | 577 |
| LANGE Forbici per bendaggi | 672 |
| LANGENBECK- KOCHER Divaricatori | 240 |
| LANGENBECK-MINI Divaricatori | 224 |
| LANGENBECK-PARKER US-ARMY Divaricatori | 231 |
| LANGENBECK-RYDER TITE GRIP Portaghi | 350 |
| LANGENBECK Tenaglia per ossa | 624 |
| LANGENBECK Coltello per lobi | 39 |
| LANGENBECK Coltello per resezione | 38 |
| LANGENBECK Divaricatori | 238-239 |
| LANGENBECK Elevatori | 575 |
| LANGENBECK Periostotomi | 587 |
| LANGENBECK Seghe per amputazione e resezione | 572 |
| LANGENBECK TITE GRIP Portaghi | 350 |
| Lapis e apparecchio per marcare e scrivere | 757 |
| Lapis per marcare e scrivere | 757 |
| Laringoscopi | 24-31 |
| Laringoscopi luce fredda | 26 |
| Laringoscopia, Spatole | 25 |
| Laser chirurgia, Strumenti | 448-451 |
| Laterale, Speculo | 448 |
| LATHBURY (FARRELL) Portacotone | 316 |
| LAWRENCE Pinza per preparazioni e legature | 187 |
| LAWTON-MATHIEU TITE GRIP Portaghi | 348 |
| LAWTON TITE GRIP Portaghi | 349 |
| LAZAR Pinze microscopia | 121 |
| LEBSCHKE Scalpello per sterno | 492 |
| LEES ATRAUMATIC-GRIP Pinze per bronchi con dentatura DE BAKEY | 552 |
| Legatori emorroidali con aspiratore | 411 |
| Legatori, Anelli di gomma | 410 |
| Legatorri emorroidali con carica | 410 |
| Legatura, Aghi | 374-376 |
| Legatura, Guida | 697 |
| Legature e dissezione, Pinze | 564 |
| Legature e dissezione, Pinze ATRAUMATIC-GRIP | 551 |
| Legature e preparazioni, Pinze | 180-189 |
| Legature e preparazioni, Pinze ATRAUMATIC-GRIP | 186 |
| Legature e torace, Pinze | 564 |
| Legature, Forbici | 352-353 |
| Legature, Forbici, DURACUT | 353 |
| Legature, Micro-pinze | 122-123 |
| Legature, Micro-pinze in TITANIO | 123 |
| Legature, Pinza TITE GRIP | 113 |
| Legature, Pinze | 152, 566 |
| LEGUEU Spatola vescicale | 268 |
| LEKSELL-STILLE Pinze per ossa | 635 |
| LELAND-JONES Pinze per vasi periferici ATRAUMATIC-GRIP | 534 |
| LEMMON Spatole intima | 512 |
| LEMPERT Curette per ossa | 604 |
| LEMPERT Periostotomi | 584 |
| LEMPERT Pinze per ossa | 631-632 |
| Lenti binoculari frontali | 8-9 |
| LERICHE Pinze emostatiche fini | 165 |
| Leva ostetrica | 481 |
| Leve per lussazione | 581 |
| Leve per ossa | 576-581 |
| Leve per sciatica | 580 |
| LEWIN Pinza per riposizioni | 622 |
| LEWIS Raspa | 592 |
| LEXER-BABY Forbici per dissezione | 87 |
| LEXER-MAYO DURACUT Forbici per dissezione | 48 |
| LEXER-MAYO Forbici per dissezione | 87 |
| LEXER-MINI Osteotomi | 612 |
| LEXER-MINI Sgorbie | 612 |
| LEXER DURACUT Forbici per dissezione | 49 |
| LEXER Forbici per dissezione | 87 |
| LEXER Osteotomi | 612-613 |
| LEXER Sgorbie | 612-613 |
| LEXER Sgorbie per tessuto osseo spongioso | 615 |
| LEYLA Accessori per autofissatori di retrattori | 703, 705 |
| LEYLA Autofissatori per retrattori cervicale | 704 |
| LEYLA Autofissatori per retrattori, per il supporto del cranio | 702 |
| LEYLA Base di fissaggio | 703 |
| LEYLA Braccio flessibile per il fissaggio delle teste di accoppiamento | 703 |
| LEYLA Giunto a sfera ad incastro | 705 |
| LEYLA Porta asta per fissaggio al giunto a sfera e alle teste di accoppiamento | 705 |
| LEYLA Supporto per spatola craniale | 703 |
| LEYLA Testa accoppiamento | 705 |
| LICHTENBERG TITE GRIP Portaghi | 349 |
| LICHTWITZ Tre quarti per puntura del seno mascellare | 319, 320 |
| LICHTWITZ VEICKEN Tre quarti per puntura del seno mascellare | 319 |
| Lima, Taglio, Raspa | 595 |
| Lime per le unghie | 18 |
| Lime per ossa | 592, 594-595 |
| LINDORF TITE GRIP Pinza gira cavo | 662 |
| Liquidi, Scodelle | 749 |
| Liquido concentrato per la cura degli strumenti chirurgici PREP LUBE | 733 |
| LISTER Cesioie per bendaggi e vestiti | 674 |
| LISTER Forbici per bendaggi | 673 |
| LISTER modif. Forbici per bendaggi | 673 |
| LISTER Pinza per medicatura e tamponi | 204 |
| LISTON-KEY-HORSLEY Cesioie per ossa | 494 |
| LISTON-LITTAUER Cesioie per ossa | 637 |
| LISTON-RUSKIN Cesioie per ossa | 638 |
| LISTON-WALTON (BÖHLER) Cesioie per ossa | 638 |
| LISTON Cesioie per ossa | 637, 639 |
| LISTON Coltello per amputazione | 38 |
| LITTAUER-LISTON Cesioie per ossa | 637 |
| LITTAUER Forbici per legature | 352 |
| LITTAUER Pinza per ciglia | 152 |
| LITTLER Forbici per dissezione | 81 |
| Lobi, Coltelli | 39 |
| Lobo polmonare e retto, Forbici | 99 |
| LOCKHART-MUMMERY Sonda per fistole | 314 |
| LOCKLIN DURACUT Forbici per gengiva | 55 |
| LOCKLIN Forbici per gengiva | 94 |
| LOCKWOOD Pinza da presa per intestino e tessuti | 386 |
| Lombo vertebrale, Chirurgia, Speculi | 295 |

| | |
|--|---------|
| LONG Pinza per isterectomia | 194 |
| LORNA Pinze per fissare le compresse | 202 |
| LOTH-KLINGENBERG Forbici per dissezione | 98 |
| LOTH-SCHOEMAKER Forbici per legature | 352 |
| LOUTE Trenditore serra filo | 660 |
| LOVE-GRUENWALD Pinze per laminectomia | 716 |
| LOVE-KERRISON (COLCLOUGH) Pinze per laminectomia | 710-711 |
| LOVE Separatori per le radici dei nervi | 701 |
| LOVELACE-DIXON Pinze emostatiche fini | 169 |
| LOVELACE Pinza da presa per intestino e tessuti | 387 |
| LOWER Pinza per preparazioni e legature | 189 |
| LOWMAN-HOGLUND Tenaglia per ossa | 630 |
| LOWMAN-LAMBERT Tenaglia per ossa | 630 |
| LOWMAN Tenaglie per ossa | 630 |
| LUCAE Diapason per neurologia | 4 |
| LUCAE Martello | 617 |
| LUCAE Pinze auricolari e nasali | 136 |
| LUCAE Uncini auricolari | 213 |
| LUCAS Curette per ossa | 599 |
| Luce fredda, Laringoscopi | 26 |
| Luce fredda, Spatole per laringoscopia | 27 |
| LUER-FRIEDMAN Pinza per ossa | 631 |
| LUER-KOERTE Cucchiali per calcoli biliari | 417 |
| LUER-STILLE Pinze per ossa | 634 |
| LUER-STILLE Pinze per ossa | 636 |
| LUER Cannule tracheali | 725 |
| LUER Divaricatori, doppi | 227 |
| LUER Pinze per ossa | 631-632 |
| LUIKART-KIELAND Forcipi | 479 |
| Lupus, Cucchiaino | 19 |
| Lupus, Raschiatoio | 20 |
| Lussazione, Leve | 581 |

M

| | |
|--|--------------|
| MAGILL Pinze introduttrici di cateteri | 32 |
| MAIER-SIMS Pinze per medicatura e tamponi | 205 |
| MAIER Pinze per medicatura e tamponi | 205 |
| MALTZ Raspa | 593 |
| MALTZ TITE GRIP Raspe | 596 |
| Manici metallici | 13 |
| Manici metallici per specchi laringei | 13 |
| Manici per bisturi | 34-35 |
| Manico a trazione | 479 |
| Manico ad uncino per fili per sega | 687 |
| Manico per aspirazione | 320 |
| Manico per lame intercambiabili, con chiave | 611 |
| Manico per meccanismo sferico di sgancio per inserire ed estrarre, Trapani | 721 |
| Mano di piombo | 644 |
| Mano, Divaricatore | 271 |
| Mano, Divaricatore e avambraccio | 271 |
| MARBACH Forbici per perineo | 107 |
| MARBERGER (GIL-VERNET) Divaricatori per veni e hilus | 223 |
| Marcare e scrivere, Lapis e apparecchio | 757 |
| MARKWALDER Pinza per costole | 494 |
| MARQUARDT Pinza per ossa | 634 |
| Martelli | 2-3, 617-621 |
| Martelli percussori | 2-3 |
| MARTIN Divaricatore per interventi in profondità | 254 |
| MARTIN Pelvimetro | 477 |
| MARTIN Pinze da presa per menisco e cartilagine | 640 |
| MARTINI Curette per ossa | 598 |
| MASSON-JUDD Divaricatore vescicale | 310 |
| MASSON Portaghi | 368 |
| MASSON TITE GRIP Portaghi | 347 |
| MASTIN Pinza muscolare | 728 |
| MATHIEU-LAWTON TITE GRIP Portaghi | 349 |
| MATHIEU Divaricatori | 231 |
| MATHIEU Divaricatori, doppi | 226 |
| MATHIEU Portaghi | 371 |
| MATHIEU Speculi rettali | 405 |
| MATHIEU Speculi vaginali | 439 |
| MATHIEU TITE GRIP Portaghi | 349 |
| MATHIEU Valve vaginali | 439 |
| MATSON Periostotomi costali | 497 |
| MATZENAUER Speculi vaginali | 440 |
| MAUNDER Apribocca | 22 |

| | |
|--|----------|
| MAYFIELD Pinza per ossa | 633 |
| MAYO-ADAMS Divaricatori per appendicectomia | 284 |
| MAYO-BLAKE Pinze per calcoli biliari | 418 |
| MAYO-HARRINGTON Forbici per dissezione | 86 |
| MAYO-HEGAR Portaghi | 367 |
| MAYO-HEGAR TITE GRIP Portaghi | 341, 345 |
| MAYO-LEXER DURACUT Forbici per dissezione | 48 |
| MAYO-LEXER Forbici per dissezione | 87 |
| MAYO-NOBLE Forbici per dissezione | 86 |
| MAYO-ROBSON ATRAUMATIC-GRIP Pinze intestinali | 396 |
| MAYO-ROBSON Pinze intestinali | 396 |
| MAYO-STILLE DURACUT Forbici per dissezione | 48 |
| MAYO-STILLE Forbici per dissezione | 85 |
| MAYO Abbassalingua | 12 |
| MAYO Cucchiali per calcoli biliari | 417 |
| MAYO Divaricatori | 249 |
| MAYO DURACUT Forbici per dissezione | 47 |
| MAYO Forbici per dissezione | 84 |
| MAYO Pinza vascolare e per tumori | 149 |
| MAYO Spilli di sicurezza | 736 |
| MC KENTY Periostotomo | 582 |
| MC DONALD Dissettori | 574 |
| MC GIVNEY Pinze per emorroidi | 410 |
| MC INDOE Cesioie per ossa | 638 |
| MC INDOE Forbici per la cartilagine | 82 |
| MC INDOE Pinza anatomica per dissezione, fine | 130 |
| MC INDOE TITE GRIP Pinze anatomiche per dissezione | 113 |
| MC INTOSH Laringoscopi | 24-27 |
| MC INTOSH Laringoscopi luce fredda | 26 |
| MC INTOSH Spatole per laringoscopi | 25 |
| MC INTOSH Spatole per laringoscopia, Luce fredda | 27 |
| MC KENZIE Filo di argento | 690 |
| MC KENZIE Fresa | 652 |
| MC KENZIE Graffe di argento | 690 |
| MC KENZIE Pinza metti graffe | 690 |
| MC KENZIE Supporto porta-graffe | 690 |
| MC PHERSON Micro-Pinze per legature | 122 |
| MEAD Martello | 618 |
| MEAD Pinze per ossa | 631 |
| Meatotomo | 426 |
| Medicatura e tamponi, Pinze | 204-207 |
| Medicature, Pinze | 208 |
| Medicinali, Bicchieri | 751 |
| Medicinali, Cucchiaino | 751 |
| MEEKER-BABY Pinze per preparazioni e legature | 180 |
| MEEKER Pinza per preparazioni e legature | 187 |
| MENGHINI Aghi per la puntura cieca del fegato | 329 |
| Menisco e cartilagine, Pinze da presa | 640 |
| Menisco, Bisturi | 642-643 |
| MERCEDES Divaricatori per il torace | 507 |
| Mettere clips, Pinza | 379 |
| METZENBAUM-BABY Forbici per dissezione | 89 |
| METZENBAUM-NELSON DURACUT Forbici per dissezione | 53 |
| METZENBAUM-NELSON Forbici per dissezione | 91 |
| METZENBAUM -THOREK DURACUT Forbici adnex | 54 |
| METZENBAUM DURACUT Forbici per dissezione | 49-54 |
| METZENBAUM Forbici per dissezione | 88-91 |
| MEYERDING Divaricatori | 225 |
| MEYERDING Divaricatori per laminectomia | 284 |
| MICHEL Graffe | 379 |
| MICHEL Pinza per mettere clips | 379 |
| MICHEL Pinza per mettere e togliere clips | 379 |
| MICHEL Specchi per rinoscopia | 14 |
| MICRO-ADSON Pinze anatomiche per dissezione, fini | 129 |
| MICRO-ADSON Pinze fini per chirurgia | 140-141 |
| MICRO-ADSON Pinze per dissezione con denti | 117 |
| MICRO-CASTROVIEJO Micro portaghi | 358 |
| MICRO-CRILE Pinze emostatiche fini | 166 |
| Micro-forbici | 62-67 |
| MICRO-HALSTED Pinze emostatiche fini | 164 |
| Micro-Pinza TITE GRIP | 118 |
| Micro-pinze | 120-125 |
| Micro-pinze per afferare tessuti | 124 |
| Micro-pinze per afferare tessuti in TITANIO | 124 |
| Micro-pinze per legature | 122 |
| Micro-Pinze per legature | 122-123 |
| Micro-pinze per legature in TITANIO | 123 |
| Micro-Portaghi TITE GRIP | 338-339 |
| Micro-strumenti, Contenitore | 737 |

| | |
|---|---------|
| Micro-strumenti, Telaio per sterilizzazione | 737 |
| Micro-tubo per aspirazione | 321 |
| Micro lame per salasso | 473 |
| Micro lame, Porta | 473 |
| Micro Pinze Bulldog | 162 |
| Micro portaghi | 358-362 |
| Micro portaghi in TITANIO | 362 |
| Micro salasso, Pipetta di vetro eparinizzata | 473 |
| Microchirurgia, Strumenti | 694-697 |
| Microchirurgia, Uncini | 212-213 |
| Microscopia, Pinze | 121 |
| MIDDELDORPF Divaricatori | 243 |
| MIKULICZ-BABY Pinza per peritoneo | 192-193 |
| MIKULICZ Divaricatore per interventi profondità | 255 |
| MIKULICZ Divaricatori per fegato | 255 |
| MIKULICZ Pinze per peritoneo | 192-193 |
| MILAN Curetta per la biopsia endo-cervicale | 460 |
| MILLER-SENN Divaricatori, doppi | 226 |
| MILLER Laringoscopi | 28-31 |
| MILLER Laringoscopi luce fredda | 30 |
| MILLER Raspe | 592 |
| MILLER Spatole per laringoscopi | 29 |
| MILLER Spatole per laringoscopia, Luce fredda | 31 |
| MILLER TITE GRIP Raspe | 596 |
| MILLESII Micro-forbici | 64 |
| MILLIGAN Dissettore per la dura-madre | 698 |
| MILLIN-YOUNG Portaghi a boomerang | 372 |
| MILLIN Dilatatore per collo vescicale | 423 |
| MILLIN Divaricatore vescicale | 310 |
| MILLIN Pinza per afferrare i lobi prostatici anteriori | 423 |
| MILLIN Pinza per prendere capsule, per prostatectomia retropubica | 423 |
| MILLIN Pinza portafilo | 423 |
| MINI-HOHMANN Leve per ossa | 576 |
| MINI-KERN Tenaglia per ossa | 625 |
| MINI-LAMBOTTE Osteotomi | 608 |
| MINI-LANGENBECK Divaricatori | 224 |
| MINI-LEXER Osteotomi | 612 |
| MINI-LEXER Sgorbie | 612 |
| MINI-STILLE Cesioie per gessi | 677 |
| Mini-trasformatore elettrico | 11 |
| MINI-YASARGIL Applicatori per clips vascolari | 154 |
| MINI-YASARGIL Clips vascolari | 154 |
| MIOTTI-OVERHOLT Pinze per preparazioni e legature | 185 |
| Misurare la profondità, Sonda | 451 |
| Misure, Sonda | 450 |
| Misure, Strumenti | 448 |
| Misurini graduati | 751 |
| MIXTER-BABY Pinze per preparazioni e legature | 180 |
| MIXTER-GEMINI Pinze per preparazioni e legature | 181 |
| MIXTER-O'SHAUGNESSY Pinze per preparazioni e legature | 182 |
| MIXTER-OVERHOLT Pinza per preparazioni e legature | 183 |
| MIXTER-PAUL Pinze per preparazioni e legature | 182 |
| MIXTER Forbici per chirurgia | 79 |
| MIXTER Pinza per preparazioni e legature | 188 |
| MIXTER Pinze per calcoli biliari | 419 |
| MIXTER Pinze per preparazioni e legature | 182 |
| MIXTER Pinze per preparazioni e legature | 189 |
| MOBERG Divaricatori | 224 |
| MOD. BONN Pinze fini per chirurgia | 138 |
| MOD. ENGL. Pinza per fissare le compresse | 200 |
| MOD. KÖLN Graffe emostatiche per cuoio capelluto | 691 |
| MOD. MÜNCHEN Curetta per la biopsia dell'endometrio | 459 |
| MOD. SCHWITZERLAND Micro-pinze | 120 |
| MOD. USA Apri gesso | 682 |
| MOD. USA Curette per ossa | 601 |
| MOD. USA Forbici ombelicali | 108 |
| MOD. USA Pinze anatomiche per dissezione | 133 |
| MOD. USA Pinze per chirurgia | 145 |
| MOD. WIENER Portalegature | 378 |
| MODELL CANAD. Bisturi per menisco | 643 |
| MODELL RUSS. Pinze vascolari e per tumori | 149 |
| MOGEN Strumento per circoncisione | 426 |
| MOLDESTAD Divaricatore per vene | 217 |
| MÖLTGEN Goniometro per le membra | 7 |
| MOORE-STAUDE Pinza per abbassare il collo dell'utero | 452 |
| MOORE Cucchiaino per colecisti | 417 |
| MORGAN-TISCHLER Pinza per la biopsia cervicale e da prelievo | 464 |
| MORRIS-DE BAKEY ATRAUMATIC-GRIP Pinze per aorta | 540 |
| MORSE Divaricatore per sternotomia | 499 |

| | |
|--|------------------------|
| MOSQUITO-BABY (HARTMAN) Pinze emostatiche fini | 164 |
| MOSQUITO-HALSTED-DE BAKEY Pinze emostatiche fini | 165 |
| MOSQUITO-HALSTED (HEISS) Pinze emostatiche fini | 170 |
| MOSQUITO-HALSTED Pinze emostatiche fini | 164-165 |
| MOTT-PARKER Divaricatori, doppi | 228 |
| MOYNIHAN Pinze emostatiche | 178 |
| MOYNIHAN Sonda con cucchiaio per calcoli biliari | 415 |
| MÜHLING (KILLIAN) Forbici per il setto nasale | 102 |
| MÜHLING Periostotomi | 584 |
| MÜLLER-BIEMER Approssimatori | 157 |
| MÜLLER-VERBRUGGE Leve per ossa | 579 |
| MÜLLER Approssimatori | 158 |
| Multiuso, Pinze ATRAUMATIC-GRIP | 520-523, 530, 556, 562 |
| Multiuso, Pinze con dentatura DARDIK ATRAUMATIC-GRIP | 554 |
| Multiuso, Pinze con dentatura DE BAKEY ATRAUMATIC-GRIP | 553 |
| MUMMERY-LOCKHART Sonda per fistole | 314 |
| MÜNCHEN MOD. Curetta per la biopsia dell'endometrio | 459 |
| MURLESS Elevatore per testa in interventi con taglio cesareo | 481 |
| MURPHY-LANE Leve per lussazione | 581 |
| MURPHY Fascia frontale | 10 |
| MURRAY-CRILE Portaghi | 366 |
| Muscolare, Pinza | 728 |
| MUSEUX Pinze per abbassare il collo dell'utero | 456 |
| MYERS Sonde per vene | 315 |

N

| | |
|--|---------|
| NABATOFF Astuccio per varici | 315 |
| NAEGELE Forcipi | 478 |
| NAGEL Micro-forbici | 67 |
| Narici posteriori, Uncini | 221 |
| Nasale, Aspirazione, Tubo | 324 |
| Nasali e auricolari, Pinze | 136-137 |
| Nasali, Forbici | 101-102 |
| Nasali, Forbici DURACUT | 58 |
| Nastro metrico di acciaio | 6 |
| Nastro metrico di tela | 6 |
| NEFF Bisturi per menisco | 642 |
| NEGUS Pinze emostatiche e per tonsille | 179 |
| NEIVERT-COTTLE Uncino per narici posteriori | 221 |
| NEIVERT TITE GRIP Portaghi | 342 |
| NEIVERTT Portaghi | 363 |
| NELATON Sonda bottonuta scanalata | 314 |
| NELSON-METZENBAUM DURACUT Forbici per dissezione | 53 |
| NELSON-METZENBAUM Forbici per dissezione | 91 |
| NELSON Pinza per chirurgia | 148 |
| NELSON Trequarti per idrocele e puntura addominale | 318 |
| Nervi e vasi, Uncini | 213-215 |
| Nervi, Forbici per dissezione | 93 |
| Neurochirurgia, Forbici | 100 |
| NEW ORLEANS Portaghi | 367 |
| NEW ORLEANS TITE GRIP Portaghi | 344 |
| NEWS Uncino tracheale | 217 |
| NOBLE-MAYO Forbici per dissezione | 86 |
| NORTHBENT SPENCER Forbici per legature | 352 |
| NOTO Pinza per polipi e ovaie | 457 |
| NOTT Speculi vaginali | 433 |
| NOVAK Curetta aspirante per la biopsia dell'endometrio | 459 |

O

| | |
|---|---------|
| O'BRIEN Forbici per legature | 352 |
| OBWEGESER Divaricatori per tessuti molli | 241 |
| OBWEGESER TITE GRIP Pinza per legatura | 113 |
| Occhiali a lenti binoculari | 9 |
| Occlusione superiore del retto, Pinza-clamp ATRAUMATIC-GRIP | 398-399 |
| Occlusione tangenziale, Pinze ATRAUMATIC-GRIP | 562 |
| Occlusione tangenziale, Pinze vascolari ATRAUMATIC-GRIP | 541 |
| OCHSNER-DIXON CRILE-RANKIN Pinze emostatiche fini | 167 |
| OCHSNER-KOCHER Pinze emostatiche | 177 |
| OCHSNER-ROCHESTER Pinze emostatiche | 178 |
| OCHSNER ATRAUMATIC-GRIP Pinze per aorta | 539 |
| OCHSNER Dilatatori per condotti biliari | 415 |
| OCHSNER Pinza per legature | 152 |
| OCHSNER Trequarti per vescica biliare | 318 |
| O'CONNOR-O'SULLIVAN Divaricatori addominali | 304 |
| O'CONNOR Uncino cutaneo | 217 |

| | |
|--|--------------|
| OEHLER Pinze chirurgiche a denti di topo | 118 |
| Oftalmologia, Aghi | 354 |
| OG Aghi per oftalmologia | 354 |
| OLDBERG Pinza ipofisaria | 719 |
| OLIVECRONA-TOENNIS (SCOVILLE) Pinza metti Graffe | 690 |
| OLIVECRONA (GIGLI) Fili per sega | 687 |
| OLIVECRONA Dissettori per la dura-madre | 700 |
| OLIVECRONA Forbici per nervo trigemino | 100 |
| OLIVECRONA Spatole cerebrali | 706 |
| OLLIER Divaricatore | 236 |
| OLSEN-HEGAR Portaghi con forbici | 370 |
| OLSEN-HEGAR TITE GRIP Portaghi | 348 |
| OLSER-BABY-HEGAR TITE GRIP Portaghi | 348 |
| Ombelicali, Clamp | 486 |
| Ombelicali, Forbici | 108 |
| Ombelicali, Pinze | 486 |
| OMBREDANNE Martello | 621 |
| Orecchio ad autoriempimento, Siringa | 332 |
| Orecchio, Siringa | 332 |
| Oscillante, Sega | 680 |
| O'SHAUGNESSY-MIXTER Pinze per preparazioni e legature | 182 |
| Ossa e costole, Pinze | 493 |
| Ossa, Cesioie | 494, 637-639 |
| Ossa, Cranio, Pinze | 688 |
| Ossa, Curette | 598-606 |
| Ossa, Divaricatori | 232 |
| Ossa, Filo | 660 |
| Ossa, Leve | 576-580 |
| Ossa, Pinze | 631-636 |
| Ossa, Tenaglie | 624-630 |
| Ossa, Trapano a mano | 651-653 |
| Ossea, Strumenti per biopsia | 669 |
| Osseo spongioso, Sgorbie per tessuto | 615 |
| Osseo, Pinze per frammento | 623 |
| Osso, Trapano | 721 |
| Osteotomi | 607-613 |
| Osteotomi, Lame intercambiabili | 611 |
| Ostetrica, Leva | 481 |
| Ostetrica, Strumenti | 481, 486 |
| O'SULLIVAN-O'CONNOR Divaricatori addominali | 304 |
| Otturatore smusso per espellere il tessuto campione | 721 |
| Ovaie e placenta, Cucchiari | 484 |
| Ovaie e placenta, Curette | 484 |
| Ovaie e placenta, Pinza | 482-483 |
| Ovaie e polipi, Pinze | 457 |
| OVERHOLT-BABY Pinza per preparazioni e legature | 183 |
| OVERHOLT-GEISSENDOERFER Pinze per preparazioni e legature | 184 |
| OVERHOLT-MIOTTI Pinze per preparazioni e legature | 185 |
| OVERHOLT-MIXTER Pinza per preparazioni e legature | 183 |
| OVERHOLT Pinze per preparazioni e legature | 183, 185 |

P

| | |
|--|---------|
| PACIFIC-KEVOURKIAN Pinza per la biopsia cervicale e da prelievo | 464 |
| Padelle | 750 |
| Parametrio, Pinze-clamps ATRAUMATIC-GRIP | 197 |
| Parametrium, Forbici DURACUT | 60 |
| PARK-ALAN Dilatore rettale con chiusura a scatto | 408 |
| PARKER-LANGENBECK US-ARMY Divaricatori | 231 |
| PARKER-MOTT Divaricatori, doppi | 228 |
| PARKER Divaricatori, doppio | 228 |
| PASQUE EUFRATE TITE GRIP Portaghi | 344 |
| Passafili, Aghi | 661 |
| Patent-ductus, Clamp ATRAUMATIC-GRIP | 556 |
| Patent-ductus, Pinze con dentatura DE BAKEY ATRAUMATIC-GRIP | 531 |
| PAUFIQUE Pinze fini per chirurgia | 139 |
| PAUL-MIXTER Pinze per preparazioni e legature | 182 |
| PAUL Divaricatore per guaina tendinea | 225 |
| PAYR-BABY Clamp per intestino e stomaco con perno | 403 |
| PAYR Aghi per sutura vascolare | 354 |
| PAYR Sonde conduttrici | 377 |
| Pb Aghi per sutura intestinale | 354 |
| PEAN-DE BAKEY ATRAUMATIC-GRIP Pinze emostatiche | 176 |
| PEAN-DE BAKEY ATRAUMATIC-GRIP Pinze vascolari | 529 |
| PEAN-ROCHESTER Pinze emostatiche | 175 |
| PEAN Pinze emostatiche | 173-174 |
| PEDERSON Speculi vaginali | 432-433 |
| PEERS Pinza per fissare le compresse | 202 |

| | |
|--|-----------------------|
| PEET Pinze per schegge | 151 |
| Pelle e dura-madre, Divaricatori | 216 |
| Pelle e dura-madre, Uncino | 217 |
| Pelle e tessuti, Uncino doppio per afferrare e sollevare | 212 |
| PELTESON Portacotone | 317 |
| Pelvometro | 477 |
| Pelvis, Divaricatori | 256-258 |
| PENFIELD Dissettori per la dura-madre | 699 |
| PENNINGTON Pinze da presa per intestino e tessuti | 387 |
| PERCY Retrattore per amputazione | 571 |
| Periduncoli renali, Pinze | 191 |
| Perineo e (episiotomia), Forbici | 107 |
| Periostio con raschiatoio, Coltello | 39 |
| Periostotomi | 496, 582-591, 694-697 |
| Periostotomi costali | 495, 497 |
| Peritoneo, Pinze | 192-193 |
| PERMAN Divaricatore addominale | 299 |
| PERTHES Punteruolo | 650 |
| Pezzi di ricambio per lenti binoculari | 8-9 |
| PHANEUF Pinze per isterectomia | 194 |
| PIERCE Tre quarti per puntura del seno mascellare | 319 |
| PIFFARD Raschiatoio per lupus | 20 |
| Piloro, Divaricatore | 403 |
| PINARD Stetoscopio | 5 |
| Pinza-clamp per occlusione superiore del retto ATRAUMATIC-GRIP | 398-399 |
| Pinza-Micro TITE GRIP | 118 |
| Pinza Bulldog ATRAUMATIC-GRIP | 556 |
| Pinza con copertura vetrificata | 152 |
| Pinza da presa per intestino e tessuti | 383-389 |
| Pinza da presa per intestino e tessuti ATRAUMATIC-GRIP | 389 |
| Pinza da presa per instino e tessuti TITE GRIP | 388 |
| Pinza emostatica per tagli cesarei | 481 |
| Pinza guida per cateteri e tubi, con manico a molla | 473 |
| Pinza guida sonda e per la protezione della dura-madre | 650 |
| Pinza iliaca ATRAUMATIC-GRIP | 558 |
| Pinza intra-uterina | 447 |
| Pinza metti graffe | 690 |
| Pinza multiuso ATRAUMATIC-GRIP | 530 |
| Pinza muscolare | 728 |
| Pinza per afferrare i lobi prostatici anteriori | 423 |
| Pinza per afferrare il rene | 421 |
| Pinza per applicare e rimuovere clamps | 527 |
| Pinza per applicare le graffe emostatiche al cuoio capelluto | 691 |
| Pinza per fissare il cordone spermatico | 425 |
| Pinza per il cuoio capelluto | 481 |
| Pinza per intestino | 149 |
| Pinza per la biopsia cervicale e da prelievo | 460 |
| Pinza per la puntura amniotica | 477 |
| Pinza per l'aneurisma dell'aorta ATRAUMATIC-GRIP | 561 |
| Pinza per legatura | 152 |
| Pinza per legature, TITE GRIP | 113 |
| Pinza per mettere clips | 379 |
| Pinza per placenta e per ovaie | 482-483 |
| Pinza per prendere capsule, per prostatectomia retropubica | 423 |
| Pinza per rotula | 623 |
| Pinza per togliere le graffe emostatiche al cuoio capelluto | 691 |
| Pinza per tubo per scanalare | 517 |
| Pinza per unghie | 645 |
| Pinza per vase periferici ATRAUMATIC-GRIP | 558 |
| Pinza portafilo | 423 |
| Pinza raccogliatrice | 735 |
| Pinza schiaccia sperone | 403 |
| Pinza schiaccia sperone e clamp per appendicectomia | 403 |
| Pinza/clamp a pressione | 409 |
| Pinze | 154-156 |
| Pinze-clamps per parametrio ATRAUMATIC-GRIP | 197 |
| Pinze-clamps per rene | 190 |
| Pinze-clamps per rene ATRAUMATIC-GRIP | 190 |
| Pinze-micro | 120-125 |
| Pinze-micro per afferare tessuti | 124 |
| Pinze-micro per afferare tessuti in TITANIO | 124 |
| Pinze-micro per legature | 122-123 |
| Pinze-micro per legature in TITANIO | 123 |
| Pinze anatomiche per dissezione | 132-134 |
| Pinze anatomiche per dissezione TITE GRIP | 112-115 |
| Pinze anatomiche per dissezione, fini | 128-131 |
| Pinze auricolari e nasali | 136-137 |
| Pinze Bulldog | 163 |
| Pinze Bulldog con dentatura DE BAKEY ATRAUMATIC-GRIP | 525-528 |

| | |
|--|-----------------------|
| Pinze Bulldog in Titanio TITAN-LINE | 160-161 |
| Pinze chirurgiche a denti di topo | 118 |
| Pinze coartazione con dentatura COOLEY ATRAUMATIC-GRIP | 557 |
| Pinze con porta clips | 378 |
| Pinze da presa per menisco e cartilagine | 640 |
| Pinze di trazione craniale, Alesatore | 689 |
| Pinze emostatica per arteria renale ATRAUMATIC-GRIP | 537 |
| Pinze emostatiche | 173-179 |
| Pinze emostatiche ATRAUMATIC-GRIP | 176 |
| Pinze emostatiche e per tonsille | 179 |
| Pinze emostatiche fini | 164-173 |
| Pinze emostatiche fini TITAN-LINE | 166, 168 |
| Pinze emostatiche per arterie renale ATRAUMATIC-GRIP | 558 |
| Pinze ferma tendine | 648 |
| Pinze fini per chirurgia | 138-143 |
| Pinze gira cavo TITE GRIP | 662 |
| Pinze guida sonda | 650 |
| Pinze intestinali | 390-396 |
| Pinze intestinali ATRAUMATIC-GRIP | 391-393, 395-396 |
| Pinze intestinali e per anastomosi | 402 |
| Pinze introduttrici di cateteri | 32 |
| Pinze ipofisaria | 719 |
| Pinze metti-rimuovi clamps Bulldog TITAN-LINE | 160 |
| Pinze Micro Bulldog | 162 |
| Pinze multiuso ATRAUMATIC-GRIP | 520-523, 556, 562 |
| Pinze multiuso con dentatura DARDIK ATRAUMATIC-GRIP | 554 |
| Pinze multiuso con dentatura DE BAKEY ATRAUMATIC-GRIP | 553 |
| Pinze ombelicali | 486 |
| Pinze passa tendine | 649 |
| Pinze patent-ductus con dentatura DE BAKEY ATRAUMATIC-GRIP | 531 |
| Pinze per abbassare il collo dell'utero | 452-456 |
| Pinze per afferrare tessuti e tumori | 126-127 |
| Pinze per afferrare e rompere le lamette da rasoio | 36 |
| Pinze per afferrare l'utero | 458 |
| Pinze per afferrare tessuti | 149 |
| Pinze per allacciare tendini | 649 |
| Pinze per anastomosi (vena cava) | 565 |
| Pinze per anastomosi ATRAUMATIC-GRIP | 520-523 |
| Pinze per anastomosi con dentatura COOLEY | 559-560 |
| Pinze per anastomosi con dentatura DE BAKEY | 542-544 |
| Pinze per anastomosi del colon | 402 |
| Pinze per anastomosi del retto | 400-401 |
| Pinze per anastomosi del retto ATRAUMATIC-GRIP | 400-401 |
| Pinze per aorta ATRAUMATIC-GRIP | 561 |
| Pinze per aorta con dentatura DE BAKEY ATRAUMATIC-GRIP | 537-540 |
| Pinze per bronchi con dentatura DE BAKEY ATRAUMATIC-GRIP | 552 |
| Pinze per calcoli biliari | 418-419 |
| Pinze per calcoli renali | 420-421 |
| Pinze per carotide ATRAUMATIC-GRIP | 537 |
| Pinze per chirurgia | 144-148 |
| Pinze per ciglia | 152 |
| Pinze per coartazione ATRAUMATIC-GRIP | 532-533 |
| Pinze per costole | 494 |
| Pinze per dissezione con denti TITE GRIP | 117 |
| Pinze per dissezione del polmone | 149 |
| Pinze per dissezione e legature | 564 |
| Pinze per dissezione e legature ATRAUMATIC-GRIP | 551 |
| Pinze per emorroidi | 410 |
| Pinze per estrazione delle unghie | 645 |
| Pinze per fissare le compresse | 200-202 |
| Pinze per frammento osseo | 623 |
| Pinze per isterectomia | 194-196 |
| Pinze per isterectomia ATRAUMATIC-GRIP | 197 |
| Pinze per la carotide ATRAUMATIC-GRIP | 527 |
| Pinze per la carotide con dentatura LAWTON ATRAUMATIC-GRIP | 524 |
| Pinze per la presa del tendine | 647 |
| Pinze per laminectomia | 707-719 |
| Pinze per l'anastomosi dell'aorta ATRAUMATIC-GRIP | 548-549 |
| Pinze per l'aneurisma dell'aorta ATRAUMATIC-GRIP | 545-547 |
| Pinze per legature | 566 |
| Pinze per medicatura e tamponi | 204-207 |
| Pinze per medicature | 208 |
| Pinze per microscopia | 121 |
| Pinze per occlusione tangenziale ATRAUMATIC-GRIP | 562 |
| Pinze per ossa | 631-636 |
| Pinze per ossa e costole | 493 |
| Pinze per ossa per cranio | 688 |
| Pinze per peduncoli renali | 191 |
| Pinze per peritoneo | 192-193 |
| Pinze per polipi e ovaie | 457 |
| Pinze per preparazioni e legature | 180-189 |
| Pinze per preparazioni e legature ATRAUMATIC-GRIP | 186 |
| Pinze per pressa tubi con rulli | 203 |
| Pinze per profondità ATRAUMATIC-GRIP | 534 |
| Pinze per riposizioni | 622-623 |
| Pinze per schegge | 150-151 |
| Pinze per sterilizzazione | 734 |
| Pinze per stomaco ATRAUMATIC-GRIP | 397 |
| Pinze per tamponi e spugne | 209-210 |
| Pinze per tessuti e per aghi TITE GRIP | 116 |
| Pinze per torace e legature | 564 |
| Pinze per trazione craniale | 689 |
| Pinze per tubi | 203 |
| Pinze per vasi periferici ATRAUMATIC-GRIP | 534-536 |
| Pinze per vena cava ATRAUMATIC-GRIP | 550 |
| Pinze porta cavo | 663-664 |
| Pinze porta cavo TITE GRIP | 663 |
| Pinze senza porta clips | 378 |
| Pinze taglianti per biopsia rettale | 412 |
| Pinze tiralingua | 23 |
| Pinze TITE GRIP | 118 |
| Pinze vascolare e per tumori | 149 |
| Pinze vascolari ATRAUMATIC-GRIP | 135, 520 |
| Pinze vascolari con dentatura COOLEY | 555-556, 558, 561-562 |
| Pinze vascolari con dentatura DE BAKEY | 529-530, 534, 537 |
| Pinze vascolari con dentatura LAWTON ATRAUMATIC-GRIP | 521-523 |
| Pinze vascolari e per tumori | 149 |
| Pinze vascolari per occlusione tangenziale ATRAUMATIC-GRIP | 541 |
| Pinze vascolari semi flessibili | 563 |
| Pinze ventricolari | 564 |
| Pinze, Sterilizzatore | 735 |
| Pinze/clamp per intestino e stomaco | 403 |
| PIPER Forcipi | 480 |
| Pipetta di vetro eparinizzata per micro salasso | 473 |
| Pistola a getto d'acqua con vari raccordi | 754 |
| Placenta e ovaie, Cucchiari | 484 |
| Placenta e ovaie, Curette | 484 |
| Placenta e ovaie, Pinza | 482-483 |
| PLESTER Divaricatori autostatici | 275 |
| Pleura, Ago per la puntura | 329, 518 |
| Pneumo-peritoneo, Aghi | 329 |
| Polipi e ovaie, Pinze | 457 |
| Polmone, Divaricatori | 260 |
| Polmone, Divaricatori e spatole | 261 |
| Polmone, Pinze per dissezione | 149 |
| POOLE Tubi aspirazione | 325 |
| Porta-graffe, Supporto | 690-691 |
| Porta asta per fissaggio al giunto a sfera | 705 |
| Porta asta per fissaggio al giunto a sfera e alle teste di accoppiamento | 705 |
| Porta asta per teste di accoppiamento | 705 |
| Porta garza uterino | 447 |
| Porta micro lame | 473 |
| Porta spugne/cotone | 473 |
| Porta targhette | 743 |
| Portacotone | 316-317, 409 |
| Portafilo, Pinza | 423 |
| Portaghi | 363-372 |
| Portaghi-Micro TITE GRIP | 338-339 |
| Portaghi a boomerang | 372 |
| Portaghi con forbici | 370 |
| Portaghi Micro | 358-362 |
| Portaghi TITAN-LINE | 365 |
| Portaghi TITE GRIP | 340-350 |
| Portalegature | 378 |
| Portapinze | 402 |
| Potrighi a boomerang, Aghi di ricambio | 372 |
| POTTS-DE BAKEY ATRAUMATIC-GRIP Pinze patent-ductus | 531 |
| POTTS-SMITH DURACUT Forbici vascolari | 56 |
| POTTS-SMITH Forbici per dissezione | 98 |
| POTTS-SMITH Forbici vascolari | 96-97 |
| POTTS-SMITH Pinze anatomiche per dissezione, fini | 131 |
| POTTS-SMITH Pinze fini per chirurgia | 143 |
| POTTS-SMITH TITE GRIP Pinze per dissezione | 114 |
| POZZI Pinza per abbassare il collo dell'utero | 453 |
| PRATT Pinze per abbassare il collo dell'utero | 455 |
| PRATT Sonde per fistola | 409 |
| PRATT Speculi rettali | 405 |
| Prelievo e cervicale, Pinza per la biopsia | 460 |

| | |
|---|----------|
| Prelievo ed aspirazione, Curette | 471 |
| PREP LUBE Detergente per strumenti | 733 |
| PREP LUBE Liquido concentrato per la cura degli strumenti chirurgici | 733 |
| Preparazioni e legature, Pinze | 180-189 |
| Preparazioni e legature, Pinze ATRAUMATIC-GRIP | 186 |
| PRESBYTERIAN Pinza per tubi | 203 |
| Pressa tubi con rotoli, Pinze | 203 |
| PRICE-THOMAS Pinze per legature | 566 |
| Profondità, Pinze ATRAUMATIC-GRIP | 534 |
| Prostata, Strumenti | 423 |
| Prostatectomia retropubica, Pinza per prendere capsule | 423 |
| Prostatici anteriori, Pinza per afferrare i lobi | 423 |
| Prostatici, Retrattori | 422 |
| Protesi dentarie, Recipienti | 751 |
| Protezione della dura-madre e guida sonda, Pinza | 650 |
| PROVIDENCE-HOSPITAL Pinze emostatiche fini | 168 |
| Pulizia, spazzole | 756 |
| Punta | 652 |
| Punta a spirale | 652 |
| Punte filiformi di KIRSCHNER | 655 |
| Punte filiformi, Distributore | 656 |
| Punte filiformi, Distributore multiplo | 657 |
| Punteruoli | 650 |
| Puntura addominale e idrocele, Tre quarti | 318 |
| Puntura amniotica, Pinza | 477 |
| Puntura cieca del fegato, Aghi | 329 |
| Puntura della pleura, Ago | 329, 518 |
| Puntura dello sterno, Aghi | 329, 518 |
| Punture lombari, Aghi | 328 |
| Punzone per sutura | 694 |
| Punzoni | 606 |
| PUTTI Raspe | 594 |
| PYNCHON-ANDREW Tubo aspirazione | 325 |

Q

| | |
|--|-----|
| QUERVAIN Elevatori | 575 |
| QUINBY Forbici per gengiva | 94 |
| QUINKE Aghi per punture lombari | 328 |

R

| | |
|--|---------|
| RABINER Martelli percussori | 3 |
| Raccogliatrice, Pinze | 735 |
| Raccordi | 333 |
| Raccordi per pistola a getto d'acqua | 755 |
| Radici dei nervi separatori | 701 |
| RADOLF Pinza per estrazione delle unghie | 645 |
| RAGNEL DURACUT Forbici per dissezione | 49 |
| RAGNEL Forbici per chirurgia e per dissezione | 83 |
| RAGNELL-DAVIS Divaricatori per chirurgia plastica | 226 |
| RALK Trapano a mano per ossa | 653 |
| RALKS (VIRTUS) Pinza per schegge | 151 |
| RAMPLEY Pinze per tamponi e spugne | 210 |
| RANDALL Curetta aspirante per la biopsia dell'endometrio | 459 |
| RANDALL Pinze per calcoli renali | 420-421 |
| RANEY Graffe emostatiche per cuoio capelluto | 691 |
| RANEY Pinza per applicare e togliere le graffe emostatiche al cuoio capelluto | 691 |
| RANEY Supporto porta-graffe | 691 |
| RANKIN-CRILE-DE BAKEY ATRAUMATIC-GRIP Pinze emostatiche fini | 167 |
| RANKIN-CRILE (OCHSNER-DIXON) Pinze emostatiche fini | 167 |
| RANKIN-CRILE Pinze emostatiche fini | 167 |
| RANKIN-KELLY Pinze emostatiche fini | 169 |
| Raschiatoio per lupus | 20 |
| Raspa, Taglio di lima | 595 |
| Raspe | 592-597 |
| Raspe TITE GRIP | 596-597 |
| RAY Curette | 692 |
| RECAMIER Curette per placenta e ovaie | 484 |
| RECAMIER Curette uterine | 468 |
| Recipienti | 747 |
| Recipienti cilindri | 747 |
| Recipienti per protesi dentarie | 751 |
| REDO Pinze intestinali | 390 |
| REDON Aghi per introduzione | 334 |
| REINER Coltello per gessi | 679 |

| | |
|--|----------|
| Renale, Pinze emostatica per arteria ATRAUMATIC-GRIP | 537 |
| Renali, Pinze per calcoli | 420-421 |
| Rene, Pinza per afferrare | 421 |
| Rene, Pinze-clamps | 190 |
| Rene, Pinze-clamps ATRAUMATIC-GRIP | 190 |
| Reniformi, Bacinelle | 750 |
| RESANO ATRAUMATIC-GRIP Pinze per anastomosi del retto | 401 |
| Resezione e amputazione, Coltello | 39 |
| Resezione e amputazione, Seghe | 572-573 |
| Resezione, Coltelli | 38 |
| Retratore doppio per estrarre il tessuto molle | 721 |
| Retratore per amputazione | 571 |
| Retrattori per ginocchio | 641 |
| Retrattori prostatici | 422 |
| Retrattori, Autofissatori per fissare alla tavola operatoria | 704 |
| Retrattori, Autofissatori per sopporto del cranio | 702 |
| Rettali, Speculi | 405-406 |
| Rettangolari, Bacinelle | 748 |
| Retto e lobo polmonare, Forbici | 99 |
| Retto, Pinze per anastomosi | 400-401 |
| REVERDIN Spatola addominale e intestinale | 267 |
| REVERDIN , Aghi | 373 |
| REYNOLDS-COOLEY ATRAUMATIC-GRIP Pinze per anastomosi | 559 |
| REYNOLDS-DE BAKEY ATRAUMATIC-GRIP Pinze per anastomosi | 542 |
| REYNOLDS Forbici fine per dissezione | 93 |
| REZEK-HEANEY Pinza per isterectomia | 196 |
| Ricambi per sega oscillante | 681 |
| Ricambio per portaghi a boomerang, Aghi | 372 |
| Ricambio, Lama | 681 |
| Ricambio, Lampada | 472 |
| RICARD Divaricatori addominali | 298 |
| RICHARDSON-EASTMAN Divaricatori | 250 |
| RICHARDSON Divaricatori | 251 |
| RICHTER-HEATH Pinza per togliere clips | 379 |
| RICHTER Forbici per chirurgia | 80 |
| RIENHOFF-FINOCHIETTO Divaricatori costali | 506 |
| Riga graduata per misure radiologiche | 6 |
| Righe graduate in acciaio | 6 |
| Rimuovere e applicare clamps, Pinze | 527 |
| Rinoplastica, Bisturi | 37 |
| Riposizioni, Pinze | 622-623 |
| ROBB Spatole e dilatatori intima | 512 |
| ROBERTS Pinze emostatiche | 178 |
| ROBSON-MAYO ATRAUMATIC-GRIP Pinze intestinali | 396 |
| ROBSON-MAYO Pinze intestinali | 396 |
| ROCHARD Dispositivo di fissaggio | 309 |
| ROCHARD Divaricatori addominali | 309 |
| ROCHARD Telaio di supporto per il fissaggio alla barra laterale del tavolo operatorio | 309 |
| ROCHESTER-CARMALT Pinze emostatiche | 178 |
| ROCHESTER-OCHSNER Pinze emostatiche | 178 |
| ROCHESTER-PEAN Pinze emostatiche | 175 |
| ROEDER Pinza per fissare le compresse | 201 |
| ROGERS DE BAKEY-HEANEY ATRAUMATIC-GRIP Pinze per isterectomia | 197 |
| ROGERS DE BAKEY-WERTHEIM ATRAUMATIC-GRIP Pinze-clamps per parametrio | 197 |
| ROGGE Pinza per sterilizzazione | 734 |
| ROLLET Divaricatore | 218 |
| Rompi gesso | 682 |
| ROSCHKE Dilatatori per l'ano | 407 |
| ROSE Divaricatori, doppi | 227 |
| ROSEGGER-KLIMA Aghi per la puntura dello sterno | 329, 518 |
| ROSEN Cannule per aspirazione | 320 |
| ROSER-KÖNIG Aprobocca | 22 |
| Rotonde, Scodelle | 749 |
| RÖTTGEN-RUSKIN Pinza per ossa | 636 |
| Rotula, Pinza | 623 |
| ROUX-BABY Divaricatore, doppio | 228 |
| ROUX Divaricatori, doppi | 229 |
| Rubinetti | 333 |
| RUDD Legatori emorroidali con carica | 410 |
| RUMEL-BELMONT Tourniquets | 518 |
| RUMEL-DE BAKEY ATRAUMATIC-GRIP Pinze per preparazioni e legature | 186 |
| RUMEL Pinze per preparazioni e legature | 186 |
| RUSKIN-LISTON Cesole per ossa | 638 |
| RUSKIN-RÖTTGEN Pinza per ossa | 636 |
| RUSKIN-STILLE Pinza per ossa | 636 |

| | |
|---|---------|
| RUSKIN Cesoie per ossa | 638 |
| RUSKIN Pinze per ossa | 633-634 |
| RUSS. MODELL Pinze vascolari e per tumori | 149 |
| RUST Seghe per amputazione e resezione | 573 |
| RYDEL-SEIFFER Diapason per neurologia | 4 |
| RYDER-LANGENBECK TITE GRIP Portaghi | 350 |
| RYDER-VASCULAP TITE GRIP Portaghi | 340 |
| RYDER TITE GRIP Portaghi | 340 |

S

| | |
|--|-----------------------|
| SAALFELD Tiracomedoni | 19 |
| SACHS Dissettori per la dura-madre | 698 |
| SACHS Uncino per dura-madre | 217 |
| SACHS Uncino per fistole | 221 |
| SACHSE Meatotomo | 426 |
| SAENGER Pinza per placenta e per ovaie | 483 |
| Salasso e l'amnioscopia, Strumentario | 472-473 |
| Salasso micro, Pipetta di vetro eparinizzata | 473 |
| Salasso, amnioscopio, conico | 472 |
| Salasso, Micro lame | 473 |
| SALENIUS Bisturi per menisco | 642 |
| SALING Amnioscopio conico | 472 |
| SALING Amnioscopio per salasso, conico | 742 |
| SAMII-YASARGIL Pinze per afferrare tessuti e tumori, a baionetta | 126 |
| SAMII Pinza per afferrare tessuti e tumori, a baionetta | 127 |
| SANVENERO Forbici fine per chirurgia | 70 |
| SAROT Pinze emostatiche fini | 171 |
| SAROT Pinze per legature | 566 |
| SAROT TITE GRIP Portaghi | 344 |
| SATINSKI Forbici per vena cava | 99 |
| SATINSKY-BABY Pinze per anastomosi (vena cava) | 565 |
| SATINSKY-DE BAKEY ATRAUMATIC-GRIP Pinze Bulldog | 525 |
| SATINSKY Pinze per anastomosi (vena cava) | 565 |
| SATTERLEE Seghe per amputazione e resezione | 572 |
| SAUER Pinze fini per chirurgia | 138 |
| SAUERBRUCH-FREY Costotomo | 493 |
| SAUERBRUCH-SCHNEIDER Periostotomo | 588 |
| SAUERBRUCH Divaricatori | 242 |
| SAUERBRUCH Pinza raccogliatrice | 735 |
| SAUERBRUCH Scatole per sterilizzare aghi da sutura | 357 |
| SCALP CONTOUR Divaricatori autostatici | 276 |
| Scalpelli | 607, 609-611, 613-614 |
| Scalpello per sterno | 492 |
| Scalpello, Lame intercambiabili | 611 |
| Scanalare e guida, Strumento | 646 |
| Scanalare, Pinza per tubo | 517 |
| Scanalare, Set | 516 |
| Scanalare, trapiantare, bypass, Strumenti | 517 |
| Scanalare, Tubo per manico | 517 |
| Scapola, Divaricatori | 260 |
| Scatole per sterilizzare aghi da sutura | 357 |
| SCHAAF Pinza per ciglia | 152 |
| SCHÄDEL Pinze per fissare le compresse | 200 |
| SCHAMBERG Tiracomedoni | 19 |
| SCHEDI Curette per ossa | 602 |
| Schegge, Pinze | 150-151 |
| SCHERBACK Speculi vaginali | 442 |
| Schiaccia sperone, Pinza | 403 |
| Schiaccia sperone, Pinza e clamp per appendicectomia | 403 |
| SCHINK Dermatomo | 41 |
| SCHMID Aghi vascolari per irrigazione | 322 |
| SCHMID Spatole intima | 513 |
| SCHMIEDEN-TEYLOR Forbici per dura madre | 100 |
| SCHMIEDEN Sonde conduttrici | 378 |
| SCHNEIDER-SAUERBRUCH Periostotomo | 588 |
| SCHNEIDER Periostotomi | 588 |
| SCHNIDT Pinze emostatiche e per tonsille | 179 |
| SCHOEMAKER-LOTH Forbici per legature | 352 |
| SCHRÖDER Curette uterine | 466 |
| SCHRÖDER Pinze per abbassare il collo dell'utero | 452, 454 |
| SCHUBERT Pinza per la biopsia cervicale e da prelievo | 461 |
| SCHULTZE Salpingografo | 474 |
| SCHUMACHER Forbici ombelicali | 108 |
| SCHUMACHER Pinza per la biopsia cervicale e da prelievo | 463 |
| SCHWARTZ Applicatore per clips vascolari | 155 |
| SCHWARTZ Clips vascolari | 155 |
| SCHWITZERLAND MOD. Micro-pinze | 120 |

| | |
|--|--------------|
| Sciatica, Leve | 580 |
| Scodelle per liquidi | 749 |
| Scodelle per soluzioni | 749 |
| Scodelle rotonde | 749 |
| SCOVILLE-HAVERFIELD Divaricatore per laminectomia | 286 |
| SCOVILLE (TOENNIS-OLIVECRONA) Pinza metti graffe | 690 |
| SCOVILLE Divaricatore per laminectomia | 286 |
| SCOVILLE Gancio per divaricatori | 287 |
| SCOVILLE Separatori per la radici dei nervi | 701 |
| SCOVILLE Valve laterali per divaricatori | 287 |
| Scrivere e marcare, Lapis e apparecchio | 757 |
| SCUDDER ATRAUMATIC-GRIP Pinze per stomaco | 397 |
| SEALY Forbici fine per chirurgia | 68 |
| SEBILEAU Elevatori | 575 |
| Secrezioni, Curetta | 425 |
| SEDILLOT Periostotomi | 586 |
| Sega oscillante | 680 |
| Sega oscillante, Ricambi | 681 |
| Sega, Fili | 687 |
| Sega, Manico ad uncino | 687 |
| Seghe per amputazione e resezione | 572-573 |
| Seghe per anelli | 645 |
| Seghe per gessi | 679 |
| SEKOND Pinze per isterectomia | 195-196 |
| SEIFFER-RYDEL Diapason per neurologia | 4 |
| SELETZ-GELPI Divaricatore per vulva | 281 |
| SELLHEIM Leva osteretrica | 481 |
| SELLORS Divaricatore ed approssimatore costale | 508 |
| SEMB Cesoia per ossa | 494 |
| SEMB Divaricatori per polmone | 260 |
| SEMB Periostotomi | 496 |
| SEMB Pinza per ossa | 494 |
| SEMB Pinze per dissezione e legature | 564 |
| SEMB Pinze per ossa e costole | 493 |
| SEMKEN Pinza per dissezione con denti | 117 |
| SEMKEN Pinze anatomiche per dissezione, fini | 130 |
| SEMKEN Pinze fini per chirurgia | 142 |
| SEMKEN TITE GRIP Pinze anatomiche per dissezione | 113 |
| SEMM Divaricatore addominale | 305 |
| SEMM Speculi vaginali | 432 |
| SENN-GREEN Divaricatori | 224 |
| SENN-MILLER Divaricatori, doppi | 226 |
| Seno mascellare, Cannule per irrigazione | 322 |
| Seno mascellare, Tre quarti per puntura | 319-320 |
| Separatori per le radici dei nervi | 701 |
| Separatori per vertebre | 296 |
| Serra filo, Trenditore | 660 |
| Serrapene | 426 |
| Serrapinze | 402 |
| Set per biopsia vertebrale | 720 |
| Set per endarterectomia | 515 |
| Set per infermiera | 18 |
| Set per scanalare | 516 |
| Set per sutura | 380 |
| Set per tracheotomia | 729-730 |
| Seta intrecciata | 353 |
| Setto nasale, Ago | 328 |
| Setto nasale, Forbici | 102 |
| Setto nasale, Forbici DURACUT | 59 |
| SEUTIN Cesoie per vestiti e gessi | 675 |
| SEWALL Periostotomo | 582 |
| Sfinteroscopi | 407 |
| Sgorbia, Lame intercambiabili | 611 |
| Sgorbie | 607, 609-616 |
| Sgorbie per tessuto osseo spongioso | 615 |
| Sgorbie spinali | 616 |
| SHAMBAUGH Uncini per microchirurgia | 212 |
| Sicurezza, Spilli | 736 |
| SIEBOLD-SIMS Forbici da utero | 106 |
| SIEBOLD Forbici da utero | 106 |
| SILVER Dermatomo | 41 |
| SIMON-HEANEY Divaricatori per interventi in profondità | 254 |
| SIMON Curette per ossa | 605 |
| SIMON Curette uterine | 466 |
| SIMON Divaricatori per interventi in profondità | 254 |
| SIMON Uncino per fistole | 221 |
| SIMPSON-BRAUN Forcipi | 478 |
| SIMPSON Isterometri | 446 |
| SIMS-MAIER Pinze per medicatura e tamponi | 205 |

| | | | |
|---|------------------|--|------------------|
| SIMS-SIEBOLD Forbici da utero | 106 | Sperone, Schiaccia, Pinza | 403 |
| SIMS Curette uterine | 467 | Spezzacrano | 485 |
| SIMS DURACUT Forbici uterine | 60 | Spilli di sicurezza | 736 |
| SIMS Forbici da utero | 104-105 | Spinali, Divaricatori | 231 |
| SIMS Isterometri | 446 | Spinali, Sgorbie | 616 |
| SIMS Speculi rettali | 405-406 | SPRATT Curette per ossa | 602 |
| SIMS Speculi vaginali, doppi | 438 | Spugne e tamponi, Pinze | 209-210 |
| SINGLEY (TUTTLE) Pinze per dissezione del polmone | 149 | Spugne/cotone, Porta | 473 |
| Siringhe da insulina | 330 | SPURLING Pinze per laminectomia | 717 |
| Siringa da tuberculina | 330 | Sputacchiera | 751 |
| Siringa per orecchio | 332 | ST. MARKUS Divaricatori per pelvis | 258 |
| Siringa per orecchio ad autorimpimento | 332 | ST. MARTIN Pinze fini per chirurgia | 139 |
| Siringhe | 330-333 | STACKE Sonda bottonuta | 313 |
| Siringhe per ferite e vescica | 331 | STADLER -BRAUN Forbici per perineo | 107 |
| SMELLIE Spezzacrano | 485 | STANDART-YASARGIL Applicatori per clips vascolari | 154 |
| SMILLIE Bisturi per menisco | 643 | STANDART-YASARGIL Clips vascolari | 154 |
| SMILLIE Retrattori per ginocchio | 641 | STAUDE-MOORE Pinza per abbassare il collo dell'utero | 452 |
| SMITH-BUIE Dilatatori per l'ano ed il retto | 408 | STEINMANN Chiodi | 654 |
| SMITH-CUSHING-FERRIS Pinze per laminectomia | 713 | STEINMANN Pinza per la presa del tendine | 647 |
| SMITH-FERRIS Pinze per chirurgia | 147 | STELLBRING Pinze per ossa | 632 |
| SMITH-HEYWOOD Pinza per polipi e ovaie | 457 | STELZNER (CRAFOORD) Forbici per lobo polmonare e per il retto | 99 |
| SMITH-HEYWOOD Pinze tiralingua | 23 | Sterilizzatore per pinze | 735 |
| SMITH-KERRISON-FERRIS Pinze per laminectomia | 709-710, 712 | Sterilizzazione e conservazione, Cestelli | 738 |
| SMITH-POTTS DURACUT Forbici vascolari | 56 | Sterilizzazione, Cestelli in acciaio perforato | 744 |
| SMITH-POTTS Forbici per dissezione | 98 | Sterilizzazione, Castello in rete metallica | 744 |
| SMITH-POTTS Forbici vascolari | 96-97 | Sterilizzazione, Cestelli | 739-741, 744-745 |
| SMITH-POTTS Pinze anatomiche per dissezione, fini | 131 | Sterilizzazione, Cestelli in plastica | 742 |
| SMITH-POTTS Pinze fini per chirurgia | 143 | Sterilizzazione, Cestelli rotondi | 743 |
| SMITH-POTTS TITE GRIP Pinze per dissezione | 114 | Sterilizzazione, Pinze | 734 |
| SMITH Forbici per bendaggi | 672 | Sterilizzazione, Scatole per aghi da sutura | 357 |
| SOFT-GREGORY Pinze per la carotide ATRAUMATIC-GRIP | 527 | Sterilizzazione, Telaio | 737 |
| Soluzioni, Scodelle | 749 | Sterilizzazione, Telaio per aghi per sutura | 736 |
| SOMER Pinza per afferrare l'utero | 458 | Sterilizzazione, Telaio per micro-strumenti | 737 |
| Sonda con cucchiaio per calcoli biliari | 415 | Sterno, Aghi per la puntura | 518 |
| Sonda doppia | 694 | Sterno, Scalpello | 492 |
| Sonda per gozzo | 378 | Sternotomia, Divaricatore | 499 |
| Sonda per misurare la profondità | 451 | Sternotomia, Divaricatore in ALLUMINIO | 498 |
| Sonda per misure | 450 | Stetoscopi | 5 |
| Sonda, Pinze guida | 650 | STEVENS Forbici fine per dissezione e per tenotomia | 92 |
| Sonde | 312-314, 450-451 | STIEGLITZ (WILLIAMS) Pinze per schegge | 151 |
| Sonde a foglia mirto | 313 | Stilette per canale lacrimale | 312 |
| Sonde auricolari | 322 | STILLE-BARRAYA Pinze per chirurgia | 148 |
| Sonde bottonute | 312-313, 694 | STILLE-CRAFOORD Pinza emostatica fine | 170 |
| Sonde bottonute scanalate | 314 | STILLE-DOYEN Divaricatori | 247 |
| Sonde con occhio | 313 | STILLE-GIERTZ Costotomo | 492 |
| Sonde conduttrici | 377-378 | STILLE-LEKSELL Pinze per ossa | 635 |
| Sonde per fistole | 314, 409 | STILLE-LUER Pinze per ossa | 634 |
| Sonde per vene | 315 | STILLE-LUER Pinze per ossa | 636 |
| Sonde rettali | 409 | STILLE-MAYO DURACUT Forbici per dissezione | 48 |
| Sonde scanalate | 314 | STILLE-MAYO Forbici per dissezione | 85 |
| Sopporto per spatola craniale | 703 | STILLE-MINI Cesioie per gessi | 677 |
| Spatola craniale, Sopporto | 703 | STILLE-RUSKIN Pinza per ossa | 636 |
| Spatole addominali e intestinali | 266-267 | STILLE-STRANDELL Divaricatori per guaina tendinea | 225 |
| Spatole cerebrali | 706 | STILLE Cesioie per gessi | 677-678 |
| Spatole e dilatatori intima | 512 | STILLE Osteotomi | 610 |
| Spatole e divaricatori per polmone | 261 | STILLE Pinza per ossa | 635 |
| Spatole intima | 512-513 | STILLE Scalpelli | 610 |
| Spatole per laringoscopi | 25 | STILLE Sgorbie | 610 |
| Spatole per laringoscopia, Luce fredda | 27 | STILLE Trapano a mano per ossa | 651 |
| Spatole vescicali | 268 | STOCKMANN Serrapene | 426 |
| Spazzola per unghie | 752 | Stomaco e intestino, Clamp con perno | 403 |
| Spazzole e asciugamani, Cestelli | 753 | Stomaco e intestino, Clamp/pinze | 403 |
| Spazzole per pulizia | 756 | Stomaco, Pinze ATRAUMATIC-GRIP | 397 |
| Spazzole, Cestelli | 753 | Strabismo, Uncini | 213 |
| Spazzole, Contenitore | 753 | STRANDELL-STILLE Divaricatori per guaina tendinea | 225 |
| Spazzole, Distributori | 752 | STRATTE TITE GRIP Portaghi | 347 |
| Spazzolino per pulire per cannule tracheali | 727 | STRAUSS Serrapene | 426 |
| Specchi frontali | 10 | STRULLY Forbici per neurochirurgia | 100 |
| Specchi laringei | 13-14 | Strumentario per isterosalpingografia | 474 |
| Specchi per rinoscopia | 14 | Strumentario per l'amnioscopia e il salasso | 472-473 |
| Speculi e valve vaginali | 434-437, 439 | Strumentario per trapanazione della cute | 20 |
| Speculi per chirurgia lombo vertebrale | 295 | Strumenti per biopsia ossea | 669 |
| Speculi rettali | 405-406 | Strumenti per biopsia vertebrale CRAIG-KOGLER | 720-721 |
| Speculi vaginali | 430-442 | Strumenti per cerchiaggio | 660 |
| Speculo laterale | 448 | Strumenti per chirurgia laser | 448-451 |
| Speculo per ipofisectomia transsfenoidale | 692 | Strumenti per esaminare e misurare | 6 |
| SPENCER-WELLS Pinze emostatiche | 173 | Strumenti per ipofisi | 692-693 |
| SPENCER (NORTHBENT) Forbici per legature | 352 | Strumenti per l'apertura del cranio | 687 |
| SPENCER Forbici per legature | 352 | Strumenti per l'urologia | 425-426 |

| | |
|--|----------|
| Strumenti per mettere i punti | 690-691 |
| Strumenti per microchirurgia | 694-697 |
| Strumenti per misurare | 7, 448 |
| Strumenti per misurare la sensibilità | 4 |
| Strumenti per operazioni della prostata | 423 |
| Strumenti per ostetricia | 481, 486 |
| Strumenti per scanalare per trapiantare, Bypass | 517 |
| Strumenti per sutura | 378 |
| Strumenti per tracheotomia | 728 |
| Strumenti, Cassette | 746 |
| Strumenti, Detergente PREP LUBE | 733 |
| Strumenti, Vassoi porta | 748 |
| Strumento biopsia per truciolini dell'iliaco | 669 |
| Strumento guida e per scanalare | 646 |
| Strumento per circoncisione | 426 |
| Strumento per introdurre cateteri o sonde | 425 |
| Strumento per ureterografia | 426 |
| SUBRAMANIAN ATRAUMATIC-GRIP Pinze per aorta | 537 |
| Succhielli per fibroma | 458 |
| Succhiello unghie | 645 |
| SULLIVAN (BROPHY) Forbici fine per dissezione | 93 |
| SUPER Combinazione stetoscopica | 5 |
| Supporto-mano | 644 |
| Supporto porta-graffe | 690-691 |
| Sutura intestinale, Aghi | 354 |
| Sutura vascolare, Aghi | 354 |
| Sutura, Aghi chirurgici | 354-356 |
| Sutura, Apparecchiatura per gastro-intestinale | 404 |
| Sutura, Forchetta | 378 |
| Sutura, Punzone | 694 |
| Sutura, Set | 380 |
| Sutura, Strumenti | 378 |
| Suture | 353 |
| SWEET-LAHEY Pinza per preparazioni e legature | 189 |
| SYSTRUNK Forbici per fissurare le unghie | 81 |

T

| | |
|---|---------|
| Tagli cesarei, Pinza emostatica | 481 |
| Taglia/curva, Tenaglie | 666 |
| Taglienti, Curette | 606 |
| Taglio cesarei, Forcipi | 480 |
| Taglio cesareo, Elevatore per testa | 481 |
| Taglio di lima, Taglio di raspa | 595 |
| TAKAHASHI Pinze per laminectomia | 714 |
| Tamponi e medicatura, Pinze | 204-207 |
| Tamponi e spugne, Pinze | 209-210 |
| Tangenziale occlusione, Pinze ATRAUMATIC-GRIP | 562 |
| Targhette di identificazione colorate | 743 |
| Targhette, Porta | 743 |
| TARNIER Forcipi | 480 |
| Tavola operatoria, Autofissatori per retrattori | 704 |
| TAYLOR-CUSHING Pinza anatomica per dissezione, fine | 131 |
| TAYLOR-CUSHING Pinza fine per chirurgia | 143 |
| TAYLOR-CUSHING Pinze auricolari e nasali | 136 |
| TAYLOR-CUSHING TITE GRIP Pinze anatomiche per dissezione | 114 |
| TAYLOR Martelli percussori | 2 |
| TAYLOR Valvola laterale per divaricatori | 287 |
| TEALE Pinze per abbassare il collo dell'utero | 456 |
| Telai per sterilizzazione | 737 |
| Telai per trattenere gli strumenti | 736 |
| Telaio | 736 |
| Telaio di supporto per il fissaggio alla barra laterale del tavolo operatorio | 309 |
| Telaio per sterilizzare aghi per sutura | 736 |
| Telaio per sterilizzazione per micro-strumenti | 737 |
| Tenaglie curva/taglia | 666 |
| Tenaglie per ossa | 624-630 |
| Tenaglie tagliafili | 666 |
| Tenaglie tagliafili DURACUT | 667 |
| Tendine, Eucleatore | 646 |
| Tendine, Guida | 646 |
| Tendine, Pinze ferma | 648 |
| Tendine, Pinze passa | 649 |
| Tendine, Pinze per la presa | 647 |
| Tendinea, Guaina, Dovaricatori | 225 |
| Tendini, Pinza per allacciare | 649 |
| Tenotomia e dissezione, Forbici fine | 92 |
| Tenotomo | 37 |

| | |
|--|--------------|
| Tessuti e aghi, Pinze TITE GRIP | 116 |
| Tessuti e intestino, Pinza da presa | 383-389 |
| Tessuti e intestino, Pinza da presa ATRAUMATIC-GRIP | 389 |
| Tessuti e intestino, Pinza da presa TITE GRIP | 388 |
| Tessuti e pelle, Uncino doppio per afferrare e sollevare | 212 |
| Tessuti e tumori, Pinze per afferrare | 126-127 |
| Tessuti molli, Divaricatori | 241 |
| Tessuti, Micro-pinze | 124 |
| Tessuti, Micro-pinze in TITANIO | 124 |
| Tessuti, Pinze per afferrare | 149 |
| Tessuto campione, Otturatore smusso per espellere | 721 |
| Tessuto molle, Retrattore doppio per estrarre | 721 |
| Tessuto molle, Trapano | 721 |
| Testa accoppiamento | 705 |
| TEYLOR-SCHMIEDEN Forbici per dura-madre | 100 |
| THOMAS-PRICE Pinze per legature | 566 |
| THOMS-ALLIS Pinza da presa per intestino e tessuti | 385 |
| THOMS-GAYLOR Pinza per la biopsia cervicale e da prelievo | 460 |
| THOREK-METZENBAUM DURACUT Forbici adnex | 54 |
| THOREK Forbici per dissezione | 98 |
| THORLAKSON ATRAUMATIC-GRIP Pinza-clamp per occlusione superiore del retto | 398-399 |
| THORLAKSON Divaricatori per pelvis | 256-257 |
| THORLAKSON Divaricatori, doppi | 230 |
| Tiracomedoni | 19 |
| Tiralingua, Pinze | 23 |
| Tiravene per endarterectomia | 514 |
| Tiroide, Divaricatore | 243 |
| TISCHLER-BABY Pinza per la biopsia cervicale e da prelievo | 464 |
| TISCHLER-MORGAN Pinza per la biopsia cervicale e da prelievo | 464 |
| TISCHLER Pinza per la biopsia cervicale e da prelievo | 465 |
| TITAN-LINE KELLY Pinze emostatiche fini | 168 |
| TITAN-LINE Pinze Bulldog in Titanio | 160-161 |
| TITAN-LINE Pinze emostatiche fini | 166, 168 |
| TITAN-LINE Pinze metti-rimuovi clamps Bulldog | 160 |
| TITAN-LINE Portaghi | 365 |
| TITANIO Micro-pinze per afferrare tessuti | 124 |
| TITANIO Micro-pinze per legature | 123 |
| TITANIO Micro portaghi | 362 |
| TITE GRIP Micro-Pinze | 118 |
| TITE GRIP Micro-Portaghi | 338-339 |
| TITE GRIP Pinza da presa per intestino e tessuti | 388 |
| TITE GRIP Pinze | 118 |
| TITE GRIP Pinze anatomiche per dissezione | 112-115 |
| TITE GRIP Pinze gira cavo | 662 |
| TITE GRIP Pinze per dissezione con denti | 117 |
| TITE GRIP Pinze per tessuti e per aghi | 116 |
| TITE GRIP Pinze porta cavo | 663 |
| TITE GRIP Portaghi | 340-350 |
| TITE GRIP Raspe | 596-597 |
| TOENNIS-ADSON DURACUT Forbici per dissezione | 49 |
| TOENNIS-ADSON Forbici per dissezione | 89 |
| TOENNIS-OLIVECRONA (SCOVILLE) Pinza metti graffe | 690 |
| TOENNIS Dissettori per la dura-madre | 700 |
| TOENNIS Forbici per chirurgia e per dissezione | 83 |
| TOENNIS Portaghi | 371 |
| TOENNIS TITE GRIP Portaghi | 350 |
| Togliere le graffe emostatiche al cuoio capelluto, Pinza | 691 |
| TOHOKU Pinze per fissare le compresse | 202 |
| TÖNNIS Coltello per dura-madre | 37 |
| Tonsille e emostatiche, Pinze | 179 |
| Tonsille, Ago | 328 |
| Tonsille, Forbici | 103 |
| Torace e legature, Pinze | 564 |
| Torace, Divaricatori | 507 |
| Tourniquets | 518 |
| TOWNSEND Pinza per la biopsia cervicale e da prelievo | 465 |
| Trachea, Divaricatore | 226 |
| Tracheali, Cannule | 725-727 |
| Tracheali, Uncini | 217, 219-220 |
| Tracheotomia, Dilatatore | 728 |
| Tracheotomia, Set | 729-730 |
| Tracheotomia, Strumenti | 728 |
| Tracheotomia, Tre quarti | 728 |
| Tracheotomia, Uncino | 728 |
| Transformatore, regolabile da 0-5 v. | 472 |
| Transsfenoidale ipofisectomia, Speculo | 692 |
| Trapanazione della cute, Strumentario | 20 |
| Trapani dermatici | 20 |

| | |
|--|--------------|
| Trapani, Manico per meccanismo sferico di sgancio per inserire ed estrarre | 721 |
| Trapano a mano per ossa | 651-653 |
| Trapano per osso | 721 |
| Trapano per tessuto molle | 721 |
| Trapiantare, Scanalare, Bypass, Strumenti | 517 |
| Trasformatore-Mini elettrico | 11 |
| Trazione, Archi | 654, 658-659 |
| Trazione, Manico | 479 |
| TRELAT Periostotomo | 582 |
| TRELAT Speculi vaginali | 431 |
| Trenditore serra filo | 660 |
| Trequarti | 318 |
| Trequarti per empiema | 318 |
| Trequarti per idrocele e puntura addominale | 318 |
| Trequarti per puntura del seno mascellare | 319-320 |
| Trequarti per tracheotomia | 728 |
| Trequarti per vescica biliare | 318 |
| Trequarti semi smusso | 721 |
| Triangolari, Bacinelle | 750 |
| Trigemino, Forbici | 100 |
| Trocar, Cannula | 721 |
| TROELTSCH (WILDE) Pinze auricolari e nasali | 137 |
| TROELTSCH Pinze auricolari e nasali | 137 |
| TROEMNER Martelli percussori | 3 |
| Tronchesine per la cuticola | 17 |
| Tronchesine per unghie | 17 |
| TROUSSEAU Dilatatore per tracheotomia | 728 |
| TROUTMAN-BARRAQUER Micro portaghi | 360 |
| TROUTMAN Pinza per afferrare e rompere le lamette da rasoio | 36 |
| Trucoli dell'iliaco, Strumento biopsia | 669 |
| TUBBS Dilatatori per l'aorta | 511 |
| Tubercolina, Siringhe | 330 |
| Tubi aspirazione | 324-327 |
| Tubi e cateteri, Pinza guida con manico a milla | 473 |
| Tubi, Pinze | 203 |
| Tubo aspirazione intracardiaca | 327 |
| Tubo aspirazione vascolare | 327 |
| Tubo per aspirazione nasale | 324 |
| Tubo per ischemia | 570 |
| Tubo per scanalare con manico | 517 |
| Tubo per scanalare, Pinza | 517 |
| TUFFIER Divaricatori costali | 506 |
| TUFFIER Spatola addominale e intestinale | 267 |
| Tumori e tessuti, Pinze per afferrare | 126-127 |
| Tumori e vascolari, Pinze | 149 |
| TUOHY Aghi per punture lombari | 328 |
| TUTTLE (SINGLEY) Pinze per dissezione del polmone | 149 |
| TYRELL GRAEFE Divaricatori cutaneo | 216 |

U

| | |
|---|--------------|
| UCKERMANN Portacotone | 317 |
| UECKERMANN-DENKER Trequarti per tracheotomia | 728 |
| UFFENORDE Curette per ossa | 601 |
| ULRICH Bisturi per fistole | 37 |
| ULRICH Pinze per medicatura e tamponi | 206 |
| ULRICH Tenaglie per ossa | 627 |
| Uncini | 449 |
| Uncini auricolare | 213 |
| Uncini per dura-madre | 212 |
| Uncini per fistole | 221 |
| Uncini per microchirurgia | 212-213 |
| Uncini per narici posteriori | 221 |
| Uncini per nervi e vasi | 213-215 |
| Uncini per strabismo | 213 |
| Uncini tracheali | 217, 219-220 |
| Uncino | 696 |
| Uncino cutaneo | 217 |
| Uncino doppio per afferrare e sollevare pelle e tessuti | 212 |
| Uncino per chirurgia plastica | 217-219 |
| Uncino per chirurgia plastica, acuti | 219 |
| Uncino per detroncazione | 485 |
| Uncino per dura-madre | 217-218 |
| Uncino per pelle e dura-madre | 217 |
| Uncino tracheale | 728 |
| Uncino, Bulbo | 422 |
| Unghie, Forbici | 16 |

| | |
|---|----------|
| Unghie, Forbici per fissurare | 81 |
| Unghie, Lime | 18 |
| Unghie, Pinza | 645 |
| Unghie, Pinza per estrazione | 645 |
| Unghie, Spazzola | 752 |
| Unghie, Succhiello | 645 |
| Unghie, Tronchesine | 17 |
| UNIVERSAL DURACUT Forbici taglia cavo | 665 |
| UNIVERSAL Forbici taglia cavo | 665 |
| UNIVERSAL Trequarti | 318 |
| Universali, Bacinelle | 748 |
| UNNA-VIDAL Tiracomedoni | 19 |
| UNNA Tiracomedoni | 19 |
| Ureterografia, Strumento | 426 |
| Uretra e cervice, Endospeculi | 443, 448 |
| Urologia, Strumenti | 425-426 |
| US-ARMY (PARKER-LANGENBECK) Divaricatori | 231 |
| USA MOD. Apri gesso | 682 |
| USA MOD. Curette per ossa | 601 |
| USA MOD. Forbici ombelicali | 108 |
| USA MOD. Pinze anatomiche per dissezione | 133 |
| USA MOD. Pinze per chirurgia | 145 |
| Uterina-intra, Pinza | 447 |
| Uterine, Curette | 466-470 |
| Uterine, Forbici DURACUT | 60 |
| Uterini, Depressori | 447 |
| Uterini, Dilatatori | 443-445 |
| Uterino, Porta garza | 447 |
| Utero, Forbici | 104-106 |
| Utero, Pinze per afferrare | 458 |

V

| | |
|---|-----------------------|
| Vaginali, Speculi | 430-442 |
| Vaginali, Speculi e valve | 434-437, 439 |
| VALLEIX Isterometri | 446 |
| Valva centrale per divaricatori addominali | 303 |
| Valve | 293 |
| Valve e speculi vaginali | 434-437, 439 |
| Valve in NYLON per divaricatori addominali | 308 |
| Valve laterali | 289 |
| Valve laterali per divaricatori addominali | 303 |
| Valve laterali per divaricatori SCOVILLE | 287 |
| Valve laterali per divaricatori TAYLOR | 287 |
| Valve per divaricatori addominali KIRSCHNER | 307 |
| VAN BUREN Pinza per frammento osseo | 623 |
| VAN DOREN Pinza per la biopsia cervicale e da prelievo | 461 |
| VANNAS-YASARGIL Micro-forbici | 66 |
| VANNAS Micro-forbici | 62-64 |
| VARCO Pinza emostatica fine | 170 |
| Varici, Astuccio | 315 |
| Vascolare e fistole, Forbici DURACUT | 45 |
| Vascolare, Aghi per sutura | 354 |
| Vascolare, Tubo aspirazione | 327 |
| Vascolari e tumori, Pinze | 149 |
| Vascolari, Clips | 154-156 |
| Vascolari, Divaricatori | 510 |
| Vascolari, Forbici | 95 |
| Vascolari, Forbici DURACUT | 56-57 |
| Vascolari, Pinze ATRAUMATIC-GRIP | 135, 520 |
| Vascolari, Pinze con dentatura COOLEY | 555-556, 558, 561-562 |
| Vascolari, Pinze con dentatura DE BAKEY | 529-530, 534, 537 |
| Vascolari, Pinze con dentatura LAWTON | 521-523 |
| Vascolari, Pinze per occlusione tangenziale ATRAUMATIC-GRIP | 541 |
| Vascolari, Pinze semi flessibili | 563 |
| VASCULAP-RYDER TITE GRIP Portaghi | 340 |
| VASCULAR Portaghi | 364 |
| VASCULAR TITAN-LINE Portaghi | 365 |
| Vascolari, Aghi per irrigazione | 322 |
| Vase periferici, Pinza ATRAUMATIC-GRIP | 558 |
| Vasi e nervi, Uncini | 213-215 |
| Vasi periferici, Pinze ATRAUMATIC-GRIP | 534-536 |
| Vasi, Bisturi | 694-695 |
| Vassoi porta strumenti | 748 |
| Vena cava, Forbici | 99 |
| Vena cava, Pinze con dentatura DE BAKEY ATRAUMATIC-GRIP | 550 |
| Vena, Sonde | 315 |
| Vene, Divaricatori | 217, 222-223 |

| | |
|---|----------|
| Vene, Forbici | 63 |
| Veni e hilus, Divaricatori | 223 |
| Ventricolari, Pinze | 564 |
| VERBRUGGE-MÜLLER Leve per ossa | 579 |
| VERBRUGGE Tenaglie per ossa | 628 |
| VERESS Aghi per il pneumo-peritoneo | 329 |
| VERNET-GIL MARBERGER Divaricatori per veni e hilus | 223 |
| Vertebre, Separatori | 296 |
| Vescica biliara, Tre quarti | 318 |
| Vescica e ferite, Siringhe | 331 |
| Vescicale, Divaricatore | 310 |
| Vesicali, Spatole | 268 |
| Vestiti e bendaggi, Cesioie | 674 |
| Vestiti e gessi, Cesioie | 675 |
| VICKERS Distributore multiplo per punte filiformi | 657 |
| VICKERS Divaricatore per dita | 271 |
| VICKERS Divaricatore per la mano | 271 |
| VICKERS Divaricatore per la mano e l'avambraccio | 271 |
| VICKERS Impugnatura a molla per dita e piccolo divaricatore per ferite | 271 |
| VICKERS Supporto-mano | 644 |
| VIDAL-UNNA Tiracomedoni | 19 |
| VIDAL Cucchiaino per lupus | 19 |
| VIRCHOW Coltello per il cervello | 40 |
| VIRTUS (RALKS) Pinza per schegge | 151 |
| WISE Micro-Pinze per legature | 122 |
| Vite guida, per dischi di fissaggio | 659 |
| VOGEL Tre quarti per puntura del seno mascellare | 319 |
| VOLKMANN Curette per ossa | 600, 602 |
| VOLKMANN Curette taglienti | 606 |
| VOLKMANN Divaricatori | 232-234 |
| Vulva, Divaricatori | 281 |

W

| | |
|--|----------|
| WAGNER Leve per ossa | 577 |
| WAGNER Martello | 620 |
| WAGNER Periostotomi | 591 |
| WAGNER Uncini auricolare | 213 |
| WALB Coltello per autopsia | 40 |
| WALDMANN Forbici per perineo | 107 |
| WALTON-LISTON (BÖHLER) Cesioie per ossa | 638 |
| WANGENSTEEN Pinze anatomiche per dissezione | 115 |
| WANGENSTEEN Portaghi | 369 |
| WANGENSTEEN TITE GRIP Portaghi | 347 |
| WARTENBERG Algesiometro | 4 |
| WATSON-CHEYNE Dissettori | 574 |
| WATSON-WILLIAMS Raspa | 593 |
| WAUGH Pinza anatomica per dissezione, fine | 131 |
| WAUGH Pinze fini per chirurgia | 143 |
| WEBER ATRAUMATIC-GRIP Pinze per l'anastomosi dell'aorta con dentatura DE BAKEY | 548 |
| WEBER Estensiometro | 4 |
| WEBSTER Portaghi | 363 |
| WEBSTER TITE GRIP Portaghi | 342 |
| WEIL-BLAKESLEY Pinze per laminectomia | 714 |
| WEISSBARTH Speculo vaginale | 442 |
| WEITLANER Divaricatori autostatici | 272-274 |
| WELLS-SPENCER Pinze emostatiche | 173 |
| WERTHEIM-CULLEN Pinze per peduncoli renali | 191 |
| WERTHEIM-DE BAKEY (ROGERS) ATRAUMATIC-GRIP Pinze-clamps per parametrio | 197 |
| WERTHEIM (BOZEMANN) TITE GRIP Portaghi | 346 |
| WERTHEIM Forbici da utero | 105 |
| WERTHEIM Pinze per isterectomia | 194-195 |
| WEST Scalpelli | 607 |
| WEST Sgorbie | 607 |
| WIENER MOD. Portalegature | 378 |
| WIENER Raspe | 593 |
| WILDE (TROELTSCH) Pinze auricolari e nasali, angolate | 137 |
| WILLETT Pinza per il cuoio capelluto | 481 |
| WILLIAMS-WATSON Raspa | 593 |
| WILLIAMS (STIEGLITZ) Pinze per schegge | 151 |
| WILLIAMS Pinze da presa per intestino e tessuti | 388 |
| WILLIGER Curette per ossa | 598, 600 |
| WILLIGER Elevatori | 574 |
| WILLIGER Martello | 617 |
| WILLIGER Periostotomo | 582 |
| WINTER Pinza per placenta e per ovaie | 482 |

| | |
|---|----------|
| WINTER Stetoscopio | 5 |
| WITNER Pinza per la biopsia cervicale e da prelievo | 462 |
| WOLFF Rompi gesso | 682 |
| WOLFSON-DE MARTEL Pinze per anastomosi del colon | 402 |
| WOLFSON-DE MARTEL Portapinze | 402 |
| WOLFSON-DE MARTEL Serrapinze | 402 |
| WOOD-CRILE Portaghi | 366, 368 |
| WOOD-CRILE TITE GRIP Portaghi | 341, 343 |
| WRIGLEY Forcipi per tagli cesarei | 480 |
| WULLSTEIN Cannula per aspirazione | 322 |
| WULLSTEIN Divaricatori autostatici | 275 |
| WULLSTEIN Micro-tubo per aspirazione | 321 |
| WYLLIE ATRAUMATIC-GRIP Pinze per l'anastomosi dell'aorta con dentatura DE BAKEY | 549 |

Y

| | |
|---|----------|
| YANKAUER Tubi aspirazione | 325-326 |
| YASARGIL-MINI Applicatori per clips vascolari | 154 |
| YASARGIL-MINI Clips vascolari | 154 |
| YASARGIL-SAMII Pinze per afferrare tessuti e tumori, a baionetta | 126 |
| YASARGIL-STANDARD Applicatori per clips vascolari | 154 |
| YASARGIL-STANDARD Clips vascolari | 154 |
| YASARGIL-VANNAS Micro-forbici | 66 |
| YASARGIL Curetta tagliente | 695 |
| YASARGIL Dissettore | 694 |
| YASARGIL Ganci galea | 691 |
| YASARGIL Guida per legatura, bottonuta | 697 |
| YASARGIL Micro-forbici | 66-67 |
| YASARGIL Micro-pinze con manici a baionetta | 125 |
| YASARGIL Micro portaghi | 362 |
| YASARGIL Periostotomi | 694-695 |
| YASARGIL Pinza ipofisaria | 719 |
| YASARGIL Pinze per afferrare tessuti e tumori, a baionetta | 126 |
| YASARGIL Tubi aspirazione | 324 |
| YEOMAN Pinze taglienti per biopsia rettale | 412 |
| YOUNG-HRYNTSCHAK Portaghi a boomerang con 1 ago | 372 |
| YOUNG-MILLIN Portaghi a boomerang | 372 |
| YOUNG Bulbo ad uncino | 422 |
| YOUNG Pinze tiralingua | 23 |
| YOUNG Retrattori prostatici | 422 |
| YOUNGE-KEVOURKIAN Curette per la biopsia endo-cervicale | 459 |
| YOUNGE-KEVOURKIAN Pinza per la biopsia cervicale e da prelievo | 463, 465 |

Z

| | |
|---|-----|
| ZAUFAL-JANSEN Pinza per ossa | 633 |
| ZENKER Divaricatori per interventi in profondità | 259 |
| ZENKER Pinze per preparazioni e legature | 188 |
| ZIEGLER Fascia frontale | 10 |
| ZIEGLER Specchio frontale | 10 |
| ZIELKE Sgorbie | 614 |
| ZOELLNER Micro-tubo per aspirazione | 321 |
| ZWEIFEL TITE GRIP Portaghi | 349 |

Nummernverzeichnis

Index of Numbers

Índice de números de referencias

Index des numéros de références

Indice dei codici

Kat. -Nr. Seite
Cat. No. Page
Núm. Ref. Página
No. Réf. Page
No. Cat. Pagina

04

04-0500 733
04-0502 733
04-0504 733
04-0506 733
04-0508 733
04-1010 34
04-1011 34
04-1012 34
04-1013 34
04-1015 34
04-1018 35
04-1020 35
04-1021 35
04-1022 35
04-1023 35
04-1024 35
04-1025 35
04-1050 34
04-1051 34
04-1055 35
04-1056 35
04-1057 34
04-1058 34
04-1059 34
04-1112 34
04-1136 35
04-1225 37
04-1228 37
04-1250 37
04-1252 37
04-1260 37
04-1270 37
04-1352 40
04-1355 40
04-1356 40
04-1357 40
04-1360 40
04-1361 40
04-1362 40
04-1385 41
04-1390 41
04-1391 41
04-1392 41
04-1395 42
04-1396 42
04-5800 674
04-5810 674

05

05-0020 63
05-0021 63
05-0023 63
05-0026 63
05-0027 63
05-0028 63

Kat. -Nr. Seite
Cat. No. Page
Núm. Ref. Página
No. Réf. Page
No. Cat. Pagina

05-0030 63
05-0031 63
05-0034 64
05-0035 64
05-0038 64
05-0039 64
05-0050 65
05-0051 65
05-0060 65
05-0061 65
05-0062 65
05-0063 65
05-0093 65
05-0095 65
05-0097 65
05-0099 65
05-0100 72
05-0101 72
05-0102 72
05-0103 72
05-0104 72
05-0105 73
05-0106 73
05-0107 73
05-0108 73
05-0109 73
05-0110 74
05-0111 74
05-0112 74
05-0113 74
05-0114 74
05-0115 75
05-0116 75
05-0117 75
05-0118 75
05-0119 75
05-0120 76
05-0121 76
05-0122 76
05-0123 76
05-0124 76
05-0125 77
05-0126 77
05-0127 77
05-0128 77
05-0129 77
05-0135 74
05-0136 74
05-0138 74
05-0145 75
05-0146 75
05-0148 75
05-0155 76
05-0156 76
05-0158 76
05-0166 80

Kat. -Nr. Seite
Cat. No. Page
Núm. Ref. Página
No. Réf. Page
No. Cat. Pagina

05-0167 80
05-0173 108
05-0174 108
05-0177 80
05-0185 77
05-0186 77
05-0188 77
05-0197 81
05-0198 81
05-0200 78
05-0201 78
05-0202 78
05-0203 78
05-0204 79
05-0205 79
05-0210 78
05-0211 78
05-0212 78
05-0213 78
05-0214 79
05-0215 79
05-0220 71
05-0221 71
05-0222 71
05-0223 71
05-0224 71
05-0225 71
05-0230 79
05-0231 79
05-0234 70
05-0235 70
05-0236 70
05-0237 70
05-0240 80
05-0241 80
05-0250 78
05-0251 78
05-0252 78
05-0253 78
05-0254 79
05-0255 79
05-0308 69
05-0309 69
05-0310 69
05-0311 69
05-0314 69
05-0315 69
05-0320 69
05-0321 69
05-0322 69
05-0323 69
05-0324 69
05-0325 69
05-0326 69
05-0330 68
05-0331 68

Kat. -Nr. Seite
Cat. No. Page
Núm. Ref. Página
No. Réf. Page
No. Cat. Pagina

05-0340 92
05-0341 92
05-0364 95
05-0366 95
05-0400 86
05-0401 86
05-0416 87
05-0417 87
05-0420 87
05-0421 87
05-0431 105
05-0433 105
05-0435 98
05-0440 94
05-0441 94
05-0443 94
05-0445 94
05-0450 84
05-0451 84
05-0452 84
05-0453 84
05-0460 84
05-0461 84
05-0464 84
05-0465 84
05-0470 86
05-0471 86
05-0482 85
05-0483 85
05-0490 85
05-0491 85
05-0492 85
05-0493 85
05-0495 85
05-0499 98
05-0541 83
05-0543 83
05-0549 81
05-0550 87
05-0551 87
05-0554 88
05-0555 88
05-0560 89
05-0561 89
05-0567 93
05-0572 83
05-0573 83
05-0575 89
05-0585 83
05-0587 83
05-0591 93
05-0593 93
05-0595 93
05-0601 93
05-0603 93
05-0607 89

| Kat. -Nr. | Seite | Kat. -Nr. | Seite | Kat. -Nr. | Seite | Kat. -Nr. | Seite |
|------------------|--------------|------------------|--------------|------------------|--------------|------------------|--------------|
| Cat. No. | Page | Cat. No. | Page | Cat. No. | Page | Cat. No. | Page |
| Núm. Ref. | Página | Núm. Ref. | Página | Núm. Ref. | Página | Núm. Ref. | Página |
| No. Réf. | Page | No. Réf. | Page | No. Réf. | Page | No. Réf. | Page |
| No. Cat. | Pagina | No. Cat. | Pagina | No. Cat. | Pagina | No. Cat. | Pagina |
| 05-0608 | 89 | 05-1466 | 49 | 05-2000 | 50 | 06-0031 | 163 |
| 05-0609 | 89 | 05-1470 | 55 | 05-2001 | 50 | 06-0032 | 163 |
| 05-0610 | 89 | 05-1471 | 55 | 05-2002 | 50 | 06-0033 | 163 |
| 05-0619 | 90 | 05-1472 | 55 | 05-2003 | 50 | 06-0035 | 527 |
| 05-0620 | 90 | 05-1473 | 55 | 05-2004 | 50 | 06-0050 | 164 |
| 05-0621 | 90 | 05-1474 | 55 | 05-2005 | 50 | 06-0051 | 164 |
| 05-0622 | 90 | 05-1476 | 55 | 05-2006 | 50 | 06-0054 | 164 |
| 05-0640 | 90 | 05-1477 | 55 | 05-2007 | 50 | 06-0055 | 164 |
| 05-0641 | 90 | 05-1481 | 45 | 05-2010 | 51 | 06-0064 | 162 |
| 05-0642 | 91 | 05-1480 | 45 | 05-2011 | 52 | 06-0065 | 162 |
| 05-0643 | 91 | 05-1491 | 49 | 05-2012 | 51 | 06-0066 | 162 |
| 05-0644 | 91 | 05-1500 | 46 | 05-2013 | 52 | 06-0067 | 162 |
| 05-0645 | 91 | 05-1501 | 46 | 05-2020 | 51 | 06-0068 | 162 |
| 05-0655 | 98 | 05-1502 | 46 | 05-2021 | 52 | 06-0069 | 162 |
| 05-0657 | 98 | 05-1503 | 46 | 05-2022 | 51 | 06-0070 | 162 |
| 05-0660 | 90 | 05-1504 | 46 | 05-2023 | 52 | 06-0071 | 162 |
| 05-0661 | 90 | 05-1505 | 46 | 05-2040 | 51 | 06-0072 | 162 |
| 05-0662 | 90 | 05-1550 | 47 | 05-2041 | 52 | 06-0075 | 162 |
| 05-0663 | 90 | 05-1551 | 47 | 05-2042 | 51 | 06-0076 | 162 |
| 05-0664 | 90 | 05-1552 | 353 | 05-2043 | 52 | 06-0077 | 162 |
| 05-0665 | 90 | 05-1553 | 353 | 05-2060 | 51 | 06-0082 | 526 |
| 05-0740 | 104 | 05-1554 | 353 | 05-2061 | 52 | 06-0083 | 526 |
| 05-0741 | 104 | 05-1555 | 48 | 05-2062 | 51 | 06-0084 | 526 |
| 05-0742 | 104 | 05-1556 | 48 | 05-2063 | 52 | 06-0085 | 526 |
| 05-0743 | 104 | 05-1560 | 47 | 05-2064 | 54 | 06-0086 | 526 |
| 05-0744 | 105 | 05-1561 | 47 | 05-2066 | 54 | 06-0087 | 526 |
| 05-0745 | 105 | 05-1565 | 48 | 05-2068 | 54 | 06-0090 | 164 |
| 05-0752 | 104 | 05-1566 | 48 | 05-2072 | 53 | 06-0091 | 164 |
| 05-0753 | 104 | 05-1570 | 47 | 05-2073 | 53 | 06-0094 | 164 |
| 05-0754 | 105 | 05-1571 | 47 | 05-2074 | 53 | 06-0095 | 164 |
| 05-0755 | 105 | 05-1579 | 49 | 05-2075 | 53 | 06-0100 | 164 |
| 05-0770 | 106 | 05-1580 | 48 | 05-2076 | 53 | 06-0101 | 164 |
| 05-0773 | 106 | 05-1581 | 48 | 05-2077 | 53 | 06-0110 | 151 |
| 05-0780 | 106 | 05-1582 | 48 | 05-2082 | 53 | 06-0120 | 164 |
| 05-0781 | 106 | 05-1583 | 48 | 05-2083 | 53 | 06-0121 | 164 |
| 05-0785 | 80 | 05-1584 | 49 | 05-2084 | 53 | 06-0122 | 165 |
| 05-0802 | 672 | 05-1585 | 49 | 05-2085 | 53 | 06-0123 | 165 |
| 05-0804 | 672 | 05-1600 | 59 | | | 06-0136 | 165 |
| 05-0806 | 672 | 05-1621 | 60 | 06 | | 06-0137 | 165 |
| 05-0820 | 673 | 05-1630 | 60 | 06-0010 | 163 | 06-0138 | 165 |
| 05-0830 | 673 | 05-1631 | 60 | 06-0011 | 163 | 06-0139 | 165 |
| 05-0835 | 673 | 05-1650 | 60 | 06-0012 | 163 | 06-0140 | 154 |
| 05-0850 | 673 | 05-1652 | 60 | 06-0013 | 163 | 06-0141 | 154 |
| 05-0860 | 673 | 05-1656 | 54 | 06-0014 | 163 | 06-0142 | 154 |
| 05-0864 | 675 | 05-1657 | 54 | 06-0015 | 163 | 06-0143 | 154 |
| 05-0895 | 673 | 05-1658 | 54 | 06-0020 | 163 | 06-0145 | 154 |
| 05-0950 | 675 | 05-1660 | 58 | 06-0021 | 163 | 06-0146 | 154 |
| 05-0952 | 675 | 05-1662 | 58 | 06-0022 | 163 | 06-0147 | 154 |
| 05-0970 | 676 | 05-1664 | 58 | 06-0023 | 163 | 06-0148 | 154 |
| 05-0975 | 676 | 05-1666 | 58 | 06-0024 | 163 | 06-0155 | 165 |
| 05-1450 | 45 | 05-1668 | 59 | 06-0025 | 163 | 06-0156 | 165 |
| 05-1455 | 45 | 05-1670 | 59 | 06-0026 | 163 | 06-0157 | 165 |
| 05-1459 | 45 | 05-1680 | 60 | 06-0027 | 163 | 06-0158 | 165 |
| 05-1460 | 45 | 05-1810 | 665 | 06-0028 | 163 | 06-0170 | 168 |
| 05-1461 | 45 | 05-1850 | 673 | 06-0029 | 163 | 06-0171 | 168 |
| 05-1465 | 49 | 05-1970 | 676 | 06-0030 | 163 | 06-0180 | 154 |

Nummernverzeichnis

Index of Numbers

Índice de números de referencias

Index des numéros de références

Indice dei codici

LAWTON
Medizintechnik

| Kat. -Nr. | Seite | Kat. -Nr. | Seite | Kat. -Nr. | Seite | Kat. -Nr. | Seite |
|------------------|--------------|------------------|--------------|------------------|--------------|------------------|--------------|
| Cat. No. | Page | Cat. No. | Page | Cat. No. | Page | Cat. No. | Page |
| Núm. Ref. | Página | Núm. Ref. | Página | Núm. Ref. | Página | Núm. Ref. | Página |
| No. Réf. | Page | No. Réf. | Page | No. Réf. | Page | No. Réf. | Page |
| No. Cat. | Pagina | No. Cat. | Pagina | No. Cat. | Pagina | No. Cat. | Pagina |
| 06-0181 | 154 | 06-0285 | 172 | 06-0410 | 177 | 06-0685 | 173 |
| 06-0182 | 154 | 06-0286 | 172 | 06-0411 | 177 | 06-0700 | 180 |
| 06-0183 | 154 | 06-0287 | 172 | 06-0412 | 177 | 06-0701 | 180 |
| 06-0184 | 154 | 06-0291 | 187 | 06-0413 | 177 | 06-0702 | 180 |
| 06-0185 | 154 | 06-0294 | 187 | 06-0414 | 177 | 06-0703 | 180 |
| 06-0190 | 154 | 06-0297 | 187 | 06-0416 | 177 | 06-0705 | 183 |
| 06-0191 | 154 | 06-0299 | 175 | 06-0420 | 176 | 06-0706 | 180 |
| 06-0192 | 154 | 06-0300 | 175 | 06-0421 | 176 | 06-0707 | 180 |
| 06-0193 | 154 | 06-0301 | 175 | 06-0422 | 176 | 06-0709 | 182 |
| 06-0200 | 168 | 06-0302 | 175 | 06-0423 | 529 | 06-0710 | 182 |
| 06-0201 | 168 | 06-0303 | 175 | 06-0425 | 176 | 06-0711 | 182 |
| 06-0203 | 165 | 06-0304 | 175 | 06-0426 | 176 | 06-0712 | 182 |
| 06-0204 | 165 | 06-0305 | 175 | 06-0427 | 176 | 06-0713 | 170 |
| 06-0206 | 168 | 06-0306 | 175 | 06-0428 | 529 | 06-0715 | 182 |
| 06-0207 | 168 | 06-0308 | 175 | 06-0433 | 529 | 06-0716 | 183 |
| 06-0210 | 166 | 06-0309 | 175 | 06-0434 | 529 | 06-0717 | 189 |
| 06-0211 | 166 | 06-0310 | 175 | 06-0435 | 529 | 06-0718 | 189 |
| 06-0212 | 166 | 06-0311 | 175 | 06-0436 | 529 | 06-0719 | 188 |
| 06-0213 | 166 | 06-0312 | 175 | 06-0450 | 167 | 06-0720 | 189 |
| 06-0214 | 166 | 06-0313 | 175 | 06-0451 | 167 | 06-0721 | 182 |
| 06-0215 | 166 | 06-0314 | 175 | 06-0458 | 176 | 06-0723 | 189 |
| 06-0216 | 176 | 06-0315 | 175 | 06-0459 | 176 | 06-0725 | 189 |
| 06-0217 | 176 | 06-0316 | 175 | 06-0460 | 176 | 06-0730 | 179 |
| 06-0218 | 166 | 06-0318 | 175 | 06-0461 | 176 | 06-0731 | 179 |
| 06-0219 | 166 | 06-0320 | 174 | 06-0470 | 156 | 06-0732 | 179 |
| 06-0220 | 167 | 06-0321 | 174 | 06-0470 | 158 | 06-0733 | 179 |
| 06-0221 | 167 | 06-0322 | 174 | 06-0471 | 156 | 06-0740 | 184 |
| 06-0222 | 167 | 06-0323 | 174 | 06-0471 | 158 | 06-0741 | 184 |
| 06-0223 | 167 | 06-0326 | 174 | 06-0475 | 156 | 06-0742 | 184 |
| 06-0224 | 167 | 06-0327 | 174 | 06-0476 | 156 | 06-0743 | 184 |
| 06-0225 | 167 | 06-0335 | 178 | 06-0477 | 156 | 06-0744 | 184 |
| 06-0230 | 169 | 06-0336 | 178 | 06-0480 | 157 | 06-0745 | 184 |
| 06-0231 | 169 | 06-0342 | 173 | 06-0481 | 157 | 06-0746 | 184 |
| 06-0240 | 169 | 06-0343 | 173 | 06-0482 | 157 | 06-0761 | 188 |
| 06-0241 | 169 | 06-0344 | 173 | 06-0483 | 157 | 06-0762 | 188 |
| 06-0242 | 171 | 06-0345 | 173 | 06-0484 | 157 | 06-0763 | 181 |
| 06-0243 | 171 | 06-0346 | 173 | 06-0485 | 158 | 06-0764 | 181 |
| 06-0244 | 169 | 06-0347 | 173 | 06-0486 | 158 | 06-0765 | 181 |
| 06-0245 | 169 | 06-0348 | 173 | 06-0487 | 158 | 06-0766 | 181 |
| 06-0250 | 169 | 06-0349 | 173 | 06-0488 | 158 | 06-0767 | 181 |
| 06-0251 | 169 | 06-0350 | 178 | 06-0489 | 159 | 06-0768 | 181 |
| 06-0260 | 170 | 06-0352 | 178 | 06-0490 | 159 | 06-0769 | 181 |
| 06-0261 | 170 | 06-0353 | 173 | 06-0491 | 159 | 06-0770 | 181 |
| 06-0263 | 170 | 06-0354 | 173 | 06-0492 | 159 | 06-0771 | 181 |
| 06-0264 | 170 | 06-0360 | 178 | 06-0493 | 159 | 06-0772 | 181 |
| 06-0265 | 170 | 06-0362 | 178 | 06-0494 | 159 | 06-0773 | 181 |
| 06-0270 | 171 | 06-0370 | 178 | 06-0500 | 169 | 06-0800 | 183 |
| 06-0271 | 171 | 06-0371 | 178 | 06-0501 | 169 | 06-0801 | 183 |
| 06-0275 | 171 | 06-0377 | 178 | 06-0510 | 390 | 06-0802 | 183 |
| 06-0276 | 170 | 06-0379 | 178 | 06-0511 | 390 | 06-0803 | 183 |
| 06-0277 | 170 | 06-0400 | 177 | 06-0520 | 390 | 06-0804 | 183 |
| 06-0280 | 172 | 06-0401 | 177 | 06-0521 | 390 | 06-0805 | 183 |
| 06-0281 | 172 | 06-0402 | 177 | 06-0620 | 387 | 06-0806 | 183 |
| 06-0282 | 172 | 06-0403 | 177 | 06-0680 | 173 | 06-0807 | 183 |
| 06-0283 | 172 | 06-0404 | 177 | 06-0682 | 173 | 06-0820 | 184 |
| 06-0284 | 172 | 06-0406 | 177 | 06-0684 | 173 | 06-0821 | 184 |

| Kat. -Nr. | Seite | Kat. -Nr. | Seite | Kat. -Nr. | Seite | Kat. -Nr. | Seite |
|------------------|--------------|------------------|--------------|------------------|--------------|------------------|--------------|
| Cat. No. | Page | Cat. No. | Page | Cat. No. | Page | Cat. No. | Page |
| Núm. Ref. | Página | Núm. Ref. | Página | Núm. Ref. | Página | Núm. Ref. | Página |
| No. Réf. | Page | No. Réf. | Page | No. Réf. | Page | No. Réf. | Page |
| No. Cat. | Pagina | No. Cat. | Pagina | No. Cat. | Pagina | No. Cat. | Pagina |
| 06-0822 | 184 | 07-0151 | 209 | 07-0626 | 739 | 07-0899 | 743 |
| 06-0823 | 184 | 07-0155 | 209 | 07-0627 | 739 | 07-0900 | 742 |
| 06-0824 | 184 | 07-0156 | 209 | 07-0700 | 738 | 07-0902 | 742 |
| 06-0825 | 184 | 07-0160 | 209 | 07-0701 | 738 | 07-0904 | 742 |
| 06-0826 | 184 | 07-0161 | 209 | 07-0702 | 738 | 07-0906 | 742 |
| 06-0830 | 185 | 07-0165 | 209 | 07-0703 | 720 | 07-0916 | 742 |
| 06-0831 | 185 | 07-0166 | 209 | 07-0705 | 738 | 07-0930 | 750 |
| 06-0832 | 185 | 07-0167 | 210 | 07-0706 | 738 | 07-0931 | 750 |
| 06-0833 | 185 | 07-0168 | 210 | 07-0707 | 740 | 07-0932 | 750 |
| 06-0834 | 185 | 07-0170 | 210 | 07-0709 | 740 | 07-0933 | 750 |
| 06-0835 | 185 | 07-0208 | 204 | 07-0710 | 738 | 07-0936 | 750 |
| 06-0836 | 185 | 07-0209 | 204 | 07-0711 | 738 | 07-0938 | 750 |
| 06-0837 | 185 | 07-0212 | 205 | 07-0712 | 738 | 07-0942 | 750 |
| 06-0838 | 185 | 07-0213 | 205 | 07-0713 | 740 | 07-0944 | 750 |
| 06-1100 | 164 | 07-0214 | 205 | 07-0714 | 740 | 07-0952 | 751 |
| 06-1101 | 164 | 07-0215 | 205 | 07-0715 | 738 | 07-0953 | 751 |
| 06-1120 | 164 | 07-0216 | 206 | 07-0716 | 738 | 07-0954 | 751 |
| 06-1121 | 164 | 07-0217 | 206 | 07-0718 | 740 | 07-0957 | 751 |
| 06-1200 | 168 | 07-0218 | 206 | 07-0719 | 740 | 07-0958 | 751 |
| 06-1201 | 168 | 07-0219 | 206 | 07-0726 | 740 | 07-0960 | 729 |
| 06-1210 | 166 | 07-0221 | 204 | 07-0727 | 740 | 07-0962 | 730 |
| 06-1211 | 166 | 07-0222 | 204 | 07-0728 | 738 | 07-0964 | 751 |
| | | 07-0226 | 204 | 07-0728 | 738 | 07-0965 | 751 |
| | | 07-0227 | 204 | 07-0730 | 744 | 07-0966 | 751 |
| | | 07-0230 | 204 | 07-0732 | 744 | 07-0967 | 751 |
| 07 | | 07-0231 | 204 | 07-0740 | 744 | 07-0968 | 751 |
| 07-0017 | 203 | 07-0236 | 205 | 07-0747 | 744 | 07-0990 | 751 |
| 07-0018 | 203 | 07-0237 | 205 | 07-0748 | 744 | 07-0991 | 751 |
| 07-0019 | 203 | 07-0243 | 207 | 07-0765 | 745 | 07-0992 | 751 |
| 07-0020 | 203 | 07-0245 | 207 | 07-0766 | 744 | 07-0992 | 751 |
| 07-0021 | 203 | 07-0248 | 207 | 07-0767 | 744 | 07-1000 | 749 |
| 07-0022 | 203 | 07-0248 | 207 | 07-0767 | 744 | 07-1001 | 749 |
| 07-0029 | 203 | 07-0260 | 734 | 07-0768 | 744 | 07-1002 | 749 |
| 07-0030 | 203 | 07-0261 | 734 | 07-0769 | 745 | 07-1003 | 749 |
| 07-0100 | 201 | 07-0265 | 734 | 07-0782 | 515 | 07-1004 | 749 |
| 07-0102 | 201 | 07-0270 | 734 | 07-0786 | 744 | 07-1010 | 749 |
| 07-0103 | 200 | 07-0282 | 734 | 07-0787 | 744 | 07-1011 | 749 |
| 07-0105 | 201 | 07-0288 | 734 | 07-0788 | 744 | 07-1012 | 749 |
| 07-0106 | 201 | 07-0295 | 736 | 07-0825 | 516 | 07-1013 | 749 |
| 07-0108 | 201 | 07-0296 | 736 | 07-0826 | 516 | 07-1015 | 749 |
| 07-0109 | 201 | 07-0297 | 736 | 07-0846 | 743 | 07-1018 | 749 |
| 07-0110 | 201 | 07-0300 | 735 | 07-0847 | 743 | 07-1019 | 749 |
| 07-0111 | 200 | 07-0302 | 735 | 07-0850 | 743 | 07-1020 | 749 |
| 07-0112 | 202 | 07-0303 | 735 | 07-0851 | 743 | 07-1021 | 749 |
| 07-0113 | 202 | 07-0304 | 735 | 07-0852 | 743 | 07-1022 | 749 |
| 07-0114 | 202 | 07-0306 | 735 | 07-0853 | 743 | 07-1023 | 749 |
| 07-0120 | 202 | 07-0307 | 735 | 07-0854 | 743 | 07-1030 | 751 |
| 07-0122 | 203 | 07-0308 | 735 | 07-0855 | 743 | 07-1031 | 751 |
| 07-0126 | 202 | 07-0350 | 736 | 07-0856 | 743 | 07-1032 | 751 |
| 07-0127 | 202 | 07-0352 | 736 | 07-0857 | 743 | 07-1034 | 751 |
| 07-0130 | 200 | 07-0400 | 736 | 07-0858 | 743 | 07-1035 | 751 |
| 07-0131 | 200 | 07-0401 | 736 | 07-0860 | 743 | 07-1036 | 751 |
| 07-0135 | 200 | 07-0607 | 739 | 07-0861 | 743 | 07-1037 | 751 |
| 07-0138 | 200 | 07-0609 | 739 | 07-0871 | 738 | 07-1038 | 751 |
| 07-0139 | 200 | 07-0613 | 739 | 07-0872 | 738 | 07-1041 | 747 |
| 07-0140 | 200 | 07-0614 | 739 | 07-0873 | 738 | 07-1042 | 747 |
| 07-0143 | 200 | 07-0618 | 739 | 07-0895 | 743 | 07-1043 | 747 |
| 07-0150 | 209 | 07-0619 | 739 | 07-0897 | 743 | | |

Nummernverzeichnis

Index of Numbers

Índice de números de referencias

Index des numéros de références

Indice dei codici

| Kat. -Nr. | Seite | Kat. -Nr. | Seite | Kat. -Nr. | Seite | Kat. -Nr. | Seite |
|------------------|--------------|------------------|--------------|------------------|--------------|------------------|--------------|
| Cat. No. | Page | Cat. No. | Page | Cat. No. | Page | Cat. No. | Page |
| Núm. Ref. | Página | Núm. Ref. | Página | Núm. Ref. | Page | Núm. Ref. | Página |
| No. Réf. | Page | No. Réf. | Page | No. Réf. | Page | No. Réf. | Page |
| No. Cat. | Página | No. Cat. | Página | No. Cat. | Página | No. Cat. | Página |
| 07-1044 | 747 | 07-1144 | 749 | 07-2020 | 756 | 08-0017 | 342 |
| 07-1045 | 747 | 07-1260 | 746 | 07-2022 | 756 | 08-0020 | 363 |
| 07-1046 | 747 | 07-1261 | 746 | 07-2024 | 756 | 08-0021 | 342 |
| 07-1047 | 747 | 07-1262 | 746 | 07-2026 | 756 | 08-0022 | 342 |
| 07-1050 | 747 | 07-1263 | 746 | 07-2028 | 756 | 08-0024 | 363 |
| 07-1051 | 747 | 07-1264 | 746 | 07-2030 | 756 | 08-0025 | 342 |
| 07-1054 | 747 | 07-1265 | 746 | 07-2032 | 756 | 08-0027 | 342 |
| 07-1055 | 747 | 07-1266 | 746 | 07-2034 | 756 | 08-0030 | 363 |
| 07-1056 | 747 | 07-1267 | 746 | 07-2036 | 756 | 08-0036 | 363 |
| 07-1057 | 747 | 07-1270 | 746 | 07-2038 | 756 | 08-0040 | 367 |
| 07-1058 | 747 | 07-1271 | 746 | 07-2100 | 754 | 08-0043 | 338 |
| 07-1059 | 747 | 07-1272 | 746 | 07-2102 | 754 | 08-0044 | 338 |
| 07-1061 | 747 | 07-1273 | 746 | 07-2104 | 755 | 08-0049 | 339 |
| 07-1066 | 737 | 07-1274 | 746 | 07-2106 | 755 | 08-0050 | 366 |
| 07-1067 | 737 | 07-1275 | 746 | 07-2108 | 755 | 08-0051 | 340 |
| 07-1071 | 747 | 07-1276 | 746 | 07-2110 | 755 | 08-0052 | 366 |
| 07-1072 | 747 | 07-1277 | 746 | 07-2112 | 755 | 08-0054 | 343 |
| 07-1073 | 747 | 07-1280 | 746 | 07-2114 | 755 | 08-0056 | 343 |
| 07-1074 | 747 | 07-1700 | 738 | 07-2116 | 755 | 08-0057 | 340 |
| 07-1075 | 747 | 07-1701 | 738 | 07-2118 | 755 | 08-0058 | 340 |
| 07-1076 | 747 | 07-1702 | 738 | 07-2120 | 755 | 08-0059 | 340 |
| 07-1077 | 747 | 07-1705 | 738 | 07-2122 | 754 | 08-0060 | 366 |
| 07-1078 | 747 | 07-1706 | 738 | 07-2124 | 754 | 08-0062 | 366 |
| 07-1081 | 747 | 07-1710 | 738 | 07-2126 | 754 | 08-0064 | 366 |
| 07-1082 | 747 | 07-1711 | 738 | 07-2128 | 754 | 08-0065 | 343 |
| 07-1083 | 747 | 07-1712 | 738 | 07-2130 | 755 | 08-0066 | 343 |
| 07-1084 | 747 | 07-1715 | 738 | 07-2132 | 755 | 08-0068 | 343 |
| 07-1085 | 747 | 07-1716 | 738 | 07-2134 | 755 | 08-0071 | 368 |
| 07-1086 | 747 | 07-1728 | 738 | 07-2150 | 757 | 08-0072 | 343 |
| 07-1087 | 747 | 07-1846 | 743 | 07-2151 | 757 | 08-0073 | 344 |
| 07-1088 | 747 | 07-1847 | 743 | 07-2152 | 757 | 08-0074 | 344 |
| 07-1100 | 748 | 07-1850 | 743 | 07-2153 | 757 | 08-0075 | 368 |
| 07-1101 | 748 | 07-1851 | 743 | 07-2154 | 757 | 08-0076 | 343 |
| 07-1102 | 748 | 07-1852 | 743 | 07-2156 | 757 | 08-0077 | 344 |
| 07-1103 | 748 | 07-1853 | 743 | 07-2707 | 741 | 08-0080 | 340 |
| 07-1104 | 748 | 07-1854 | 743 | 07-2709 | 741 | 08-0081 | 340 |
| 07-1105 | 748 | 07-1855 | 743 | 07-2713 | 741 | 08-0082 | 366 |
| 07-1106 | 748 | 07-1856 | 743 | 07-2714 | 741 | 08-0084 | 340 |
| 07-1110 | 748 | 07-1857 | 743 | 07-2718 | 741 | 08-0085 | 340 |
| 07-1111 | 748 | 07-1858 | 743 | 07-2719 | 741 | 08-0087 | 340 |
| 07-1112 | 748 | 07-1860 | 743 | 07-2726 | 741 | 08-0090 | 367 |
| 07-1113 | 748 | 07-1861 | 743 | 07-2727 | 741 | 08-0092 | 371 |
| 07-1114 | 748 | 07-1871 | 738 | | | 08-0096 | 338 |
| 07-1120 | 748 | 07-1872 | 738 | 08 | | 08-0097 | 338 |
| 07-1130 | 749 | 07-1873 | 738 | 08-0001 | 339 | 08-0100 | 343 |
| 07-1131 | 749 | 07-2000 | 752 | 08-0002 | 339 | 08-0101 | 343 |
| 07-1132 | 749 | 07-2002 | 752 | 08-0003 | 339 | 08-0102 | 343 |
| 07-1133 | 749 | 07-2003 | 752 | 08-0004 | 339 | 08-0103 | 343 |
| 07-1134 | 749 | 07-2004 | 752 | 08-0005 | 339 | 08-0111 | 348 |
| 07-1135 | 749 | 07-2006 | 752 | 08-0010 | 363 | 08-0112 | 370 |
| 07-1136 | 749 | 07-2007 | 752 | 08-0011 | 342 | 08-0113 | 348 |
| 07-1137 | 749 | 07-2008 | 752 | 08-0012 | 342 | 08-0114 | 370 |
| 07-1140 | 749 | 07-2010 | 753 | 08-0013 | 342 | 08-0115 | 348 |
| 07-1141 | 749 | 07-2011 | 753 | 08-0014 | 366 | 08-0116 | 370 |
| 07-1142 | 749 | 07-2012 | 753 | 08-0015 | 342 | 08-0117 | 348 |
| 07-1143 | 749 | 07-2014 | 753 | 08-0016 | 363 | 08-0118 | 348 |

Nummernverzeichnis

Index of Numbers

Indice de números de referencias

Index des numéros de références

Indice dei codici

| Kat. -Nr. | Seite | Kat. -Nr. | Seite | Kat. -Nr. | Seite | Kat. -Nr. | Seite |
|------------------|--------------|------------------|--------------|------------------|--------------|------------------|--------------|
| Cat. No. | Page | Cat. No. | Page | Cat. No. | Page | Cat. No. | Page |
| Núm. Ref. | Página | Núm. Ref. | Página | Núm. Ref. | Página | Núm. Ref. | Página |
| No. Réf. | Page | No. Réf. | Page | No. Réf. | Page | No. Réf. | Page |
| No. Cat. | Pagina | No. Cat. | Pagina | No. Cat. | Pagina | No. Cat. | Pagina |
| 08-0119 | 348 | 08-0287 | 346 | 08-0600 | 379 | 08-1204 | 355 |
| 08-0124 | 349 | 08-0288 | 346 | 08-0605 | 379 | 08-1205 | 355 |
| 08-0127 | 349 | 08-0294 | 662 | 08-0610 | 379 | 08-1206 | 355 |
| 08-0128 | 349 | 08-0296 | 662 | 08-0611 | 379 | 08-1207 | 355 |
| 08-0129 | 349 | 08-0297 | 662 | 08-0612 | 379 | 08-1208 | 355 |
| 08-0132 | 348 | 08-0298 | 662 | 08-0614 | 379 | 08-1209 | 355 |
| 08-0136 | 349 | 08-0299 | 662 | 08-0616 | 379 | 08-1210 | 355 |
| 08-0144 | 348 | 08-0337 | 371 | 08-0618 | 379 | 08-1211 | 355 |
| 08-0145 | 349 | 08-0338 | 371 | 08-0620 | 379 | 08-1212 | 355 |
| 08-0147 | 349 | 08-0339 | 371 | 08-0622 | 379 | 08-1213 | 355 |
| 08-0151 | 350 | 08-0340 | 368 | 08-0650 | 379 | 08-1214 | 355 |
| 08-0152 | 350 | 08-0342 | 371 | 08-0652 | 379 | 08-1215 | 355 |
| 08-0155 | 350 | 08-0350 | 369 | 08-0772 | 378 | 08-1216 | 355 |
| 08-0156 | 350 | 08-0356 | 369 | 08-0775 | 378 | 08-1218 | 355 |
| 08-0157 | 350 | 08-0364 | 369 | 08-0800 | 665 | 08-1219 | 355 |
| 08-0158 | 344 | 08-0401 | 373 | 08-0801 | 665 | 08-1220 | 355 |
| 08-0159 | 344 | 08-0402 | 373 | 08-0804 | 665 | 08-1221 | 355 |
| 08-0160 | 344 | 08-0403 | 373 | 08-0805 | 665 | 08-1222 | 355 |
| 08-0162 | 350 | 08-0404 | 373 | 08-0810 | 665 | 08-1223 | 355 |
| 08-0163 | 350 | 08-0406 | 373 | 08-0840 | 352 | 08-1224 | 355 |
| 08-0173 | 344 | 08-0407 | 373 | 08-0844 | 352 | 08-1225 | 355 |
| 08-0175 | 344 | 08-0408 | 373 | 08-0845 | 352 | 08-1226 | 355 |
| 08-0176 | 370 | 08-0409 | 373 | 08-0846 | 352 | 08-1227 | 355 |
| 08-0177 | 370 | 08-0412 | 374 | 08-0847 | 352 | 08-1228 | 355 |
| 08-0179 | 345 | 08-0413 | 374 | 08-0848 | 352 | 08-1229 | 355 |
| 08-0180 | 367 | 08-0421 | 374 | 08-0850 | 352 | 08-1230 | 355 |
| 08-0181 | 345 | 08-0422 | 374 | 08-0851 | 352 | 08-1231 | 355 |
| 08-0182 | 367 | 08-0423 | 374 | 08-0875 | 352 | 08-1232 | 355 |
| 08-0183 | 345 | 08-0424 | 374 | 08-0888 | 666 | 08-1233 | 355 |
| 08-0184 | 367 | 08-0425 | 375 | 08-0890 | 666 | 08-1234 | 355 |
| 08-0185 | 345 | 08-0426 | 375 | 08-0910 | 380 | 08-1235 | 355 |
| 08-0186 | 345 | 08-0427 | 375 | 08-1020 | 364 | 08-1236 | 355 |
| 08-0187 | 345 | 08-0428 | 375 | 08-1022 | 364 | 08-1258 | 356 |
| 08-0188 | 345 | 08-0437 | 375 | 08-1024 | 364 | 08-1259 | 356 |
| 08-0189 | 345 | 08-0438 | 375 | 08-1026 | 364 | 08-1260 | 356 |
| 08-0190 | 349 | 08-0462 | 376 | 08-1028 | 364 | 08-1261 | 356 |
| 08-0195 | 345 | 08-0463 | 376 | 08-1030 | 365 | 08-1262 | 356 |
| 08-0196 | 345 | 08-0464 | 375 | 08-1032 | 365 | 08-1263 | 356 |
| 08-0197 | 345 | 08-0465 | 375 | 08-1034 | 365 | 08-1264 | 356 |
| 08-0198 | 345 | 08-0476 | 376 | 08-1036 | 365 | 08-1265 | 356 |
| 08-0208 | 367 | 08-0477 | 376 | 08-1038 | 365 | 08-1266 | 356 |
| 08-0210 | 367 | 08-0478 | 376 | 08-1131 | 356 | 08-1309 | 354 |
| 08-0221 | 340 | 08-0479 | 376 | 08-1132 | 356 | 08-1310 | 354 |
| 08-0223 | 340 | 08-0484 | 374 | 08-1133 | 356 | 08-1311 | 354 |
| 08-0225 | 340 | 08-0491 | 374 | 08-1134 | 356 | 08-1312 | 354 |
| 08-0227 | 340 | 08-0520 | 377 | 08-1135 | 356 | 08-1313 | 354 |
| 08-0230 | 346 | 08-0521 | 377 | 08-1136 | 356 | 08-1314 | 354 |
| 08-0231 | 346 | 08-0522 | 377 | 08-1137 | 356 | 08-1315 | 354 |
| 08-0232 | 346 | 08-0525 | 378 | 08-1138 | 356 | 08-1316 | 354 |
| 08-0241 | 347 | 08-0540 | 377 | 08-1139 | 356 | 08-1317 | 354 |
| 08-0245 | 347 | 08-0541 | 377 | 08-1198 | 355 | 08-1318 | 354 |
| 08-0247 | 344 | 08-0542 | 377 | 08-1199 | 355 | 08-1341 | 356 |
| 08-0255 | 346 | 08-0548 | 377 | 08-1200 | 355 | 08-1342 | 356 |
| 08-0257 | 346 | 08-0552 | 378 | 08-1201 | 355 | 08-1343 | 356 |
| 08-0261 | 347 | 08-0570 | 378 | 08-1202 | 355 | 08-1344 | 356 |
| 08-0263 | 347 | 08-0572 | 378 | 08-1203 | 355 | 08-1345 | 356 |

Nummernverzeichnis

Index of Numbers

Índice de números de referencias

Index des numéros de références

Indice dei codici

LAWTON
Medizintechnik

| Kat. -Nr. | Seite | Kat. -Nr. | Seite | Kat. -Nr. | Seite | Kat. -Nr. | Seite |
|------------------|--------------|------------------|--------------|------------------|--------------|------------------|--------------|
| Cat. No. | Page | Cat. No. | Page | Cat. No. | Page | Cat. No. | Page |
| Núm. Ref. | Página | Núm. Ref. | Página | Núm. Ref. | Página | Núm. Ref. | Página |
| No. Réf. | Page | No. Réf. | Page | No. Réf. | Page | No. Réf. | Page |
| No. Cat. | Pagina | No. Cat. | Pagina | No. Cat. | Pagina | No. Cat. | Pagina |
| 08-1346 | 356 | 09-0091 | 133 | 09-0204 | 144 | 09-0532 | 148 |
| 08-1410 | 354 | 09-0092 | 133 | 09-0205 | 144 | 09-0533 | 148 |
| 08-1411 | 354 | 09-0093 | 133 | 09-0216 | 146 | 09-0537 | 149 |
| 08-1412 | 354 | 09-0094 | 133 | 09-0221 | 146 | 09-0538 | 149 |
| 08-1413 | 354 | 09-0109 | 132 | 09-0226 | 146 | 09-0539 | 149 |
| 08-1414 | 354 | 09-0110 | 133 | 09-0231 | 146 | 09-0540 | 149 |
| 08-1415 | 354 | 09-0111 | 132 | 09-0232 | 121 | 09-0542 | 149 |
| 08-1489 | 354 | 09-0115 | 133 | 09-0236 | 146 | 09-0544 | 149 |
| 08-1490 | 354 | 09-0116 | 132 | 09-0239 | 131 | 09-0548 | 149 |
| 08-1491 | 354 | 09-0117 | 133 | 09-0241 | 146 | 09-0555 | 149 |
| 08-1492 | 354 | 09-0120 | 133 | 09-0261 | 146 | 09-0556 | 149 |
| 08-1493 | 354 | 09-0121 | 132 | 09-0266 | 146 | 09-0560 | 131 |
| 08-1509 | 354 | 09-0123 | 134 | 09-0276 | 146 | 09-0565 | 131 |
| 08-1510 | 354 | 09-0124 | 133 | 09-0277 | 146 | 09-0570 | 131 |
| 08-1511 | 354 | 09-0125 | 133 | 09-0280 | 134 | 09-0572 | 131 |
| 08-1512 | 354 | 09-0127 | 134 | 09-0284 | 131 | 09-0575 | 143 |
| 08-1513 | 354 | 09-0128 | 132 | 09-0285 | 131 | 09-0580 | 143 |
| 08-1632 | 380 | 09-0129 | 134 | 09-0286 | 143 | 09-0585 | 143 |
| 08-1641 | 357 | 09-0130 | 133 | 09-0287 | 143 | 09-0587 | 143 |
| 08-1643 | 357 | 09-0131 | 132 | 09-0351 | 148 | 09-0610 | 130 |
| 08-1644 | 357 | 09-0135 | 133 | 09-0370 | 129 | 09-0611 | 130 |
| 08-1650 | 357 | 09-0136 | 132 | 09-0371 | 140 | 09-0616 | 142 |
| 08-1651 | 357 | 09-0140 | 133 | 09-0375 | 129 | 09-0617 | 142 |
| 08-1659 | 357 | 09-0141 | 132 | 09-0376 | 129 | 09-0660 | 148 |
| 08-1660 | 357 | 09-0146 | 132 | 09-0377 | 129 | 09-0679 | 122 |
| 08-1662 | 357 | 09-0149 | 144 | 09-0378 | 129 | 09-0680 | 122 |
| 08-1665 | 353 | 09-0150 | 145 | 09-0380 | 140 | 09-0700 | 131 |
| 08-1669 | 353 | 09-0151 | 144 | 09-0383 | 140 | 09-0705 | 143 |
| 08-1670 | 353 | 09-0155 | 145 | 09-0385 | 140 | 09-0710 | 136 |
| 08-1671 | 353 | 09-0156 | 144 | 09-0390 | 141 | 09-0715 | 136 |
| 08-2011 | 341 | 09-0160 | 145 | 09-0391 | 141 | 09-0740 | 130 |
| 08-2065 | 341 | 09-0161 | 144 | 09-0395 | 129 | 09-0742 | 130 |
| 08-2068 | 341 | 09-0165 | 145 | 09-0396 | 140 | 09-0745 | 142 |
| 08-2181 | 341 | 09-0168 | 144 | 09-0397 | 141 | 09-0800 | 137 |
| 08-2183 | 341 | 09-0170 | 145 | 09-0398 | 141 | 09-0801 | 137 |
| | | 09-0171 | 144 | 09-0399 | 141 | 09-0804 | 137 |
| 09 | | 09-0175 | 145 | 09-0400 | 141 | 09-0806 | 137 |
| 09-0006 | 128 | 09-0176 | 144 | 09-0410 | 148 | 09-0808 | 137 |
| 09-0007 | 128 | 09-0180 | 145 | 09-0415 | 148 | 09-0809 | 137 |
| 09-0009 | 128 | 09-0181 | 144 | 09-0420 | 148 | 09-0812 | 136 |
| 09-0010 | 128 | 09-0186 | 144 | 09-0422 | 131 | 09-0814 | 136 |
| 09-0011 | 128 | 09-0188 | 132 | 09-0423 | 143 | 09-0815 | 136 |
| 09-0013 | 128 | 09-0189 | 132 | 09-0425 | 142 | 09-0818 | 136 |
| 09-0016 | 128 | 09-0190 | 132 | 09-0438 | 130 | 09-0819 | 136 |
| 09-0017 | 128 | 09-0191 | 134 | 09-0489 | 147 | 09-0830 | 150 |
| 09-0019 | 128 | 09-0192 | 132 | 09-0490 | 147 | 09-0832 | 150 |
| 09-0020 | 139 | 09-0193 | 144 | 09-0495 | 147 | 09-0870 | 151 |
| 09-0021 | 139 | 09-0194 | 145 | 09-0496 | 147 | 09-0871 | 151 |
| 09-0023 | 139 | 09-0195 | 144 | 09-0497 | 147 | 09-0901 | 121 |
| 09-0026 | 139 | 09-0196 | 144 | 09-0499 | 147 | 09-0902 | 121 |
| 09-0027 | 139 | 09-0197 | 145 | 09-0500 | 147 | 09-0903 | 121 |
| 09-0029 | 139 | 09-0198 | 144 | 09-0501 | 147 | 09-0920 | 150 |
| 09-0040 | 130 | 09-0200 | 132 | 09-0520 | 148 | 09-0921 | 150 |
| 09-0042 | 130 | 09-0201 | 132 | 09-0525 | 148 | 09-0922 | 150 |
| 09-0044 | 142 | 09-0202 | 132 | 09-0530 | 148 | 09-0923 | 150 |
| 09-0046 | 142 | 09-0203 | 132 | 09-0531 | 148 | 09-0924 | 150 |

Nummernverzeichnis

Index of Numbers

Indice de números de referencias

Index des numéros de références

Indice dei codici

| Kat. -Nr. | Seite | Kat. -Nr. | Seite | Kat. -Nr. | Seite | Kat. -Nr. | Seite |
|------------------|--------------|------------------|--------------|------------------|--------------|------------------|--------------|
| Cat. No. | Page | Cat. No. | Page | Cat. No. | Page | Cat. No. | Page |
| Núm. Ref. | Página | Núm. Ref. | Página | Núm. Ref. | Página | Núm. Ref. | Página |
| No. Réf. | Page | No. Réf. | Page | No. Réf. | Page | No. Réf. | Page |
| No. Cat. | Pagina | No. Cat. | Pagina | No. Cat. | Pagina | No. Cat. | Pagina |
| 09-0925 | 150 | 09-1185 | 118 | 10 | | 10-0440 | 390 |
| 09-0926 | 150 | 09-1376 | 113 | 10-0102 | 383 | 10-0442 | 391 |
| 09-0927 | 150 | 09-1377 | 113 | 10-0105 | 383 | 10-0443 | 391 |
| 09-0931 | 150 | 09-1379 | 113 | 10-0106 | 383 | 10-0456 | 393 |
| 09-0933 | 150 | 09-1380 | 113 | 10-0110 | 384 | 10-0457 | 393 |
| 09-0940 | 150 | 09-1382 | 113 | 10-0115 | 384 | 10-0458 | 392 |
| 09-0941 | 150 | 09-1384 | 113 | 10-0120 | 383 | 10-0459 | 392 |
| 09-0950 | 120 | 09-1386 | 114 | 10-0125 | 384 | 10-0460 | 393 |
| 09-0952 | 120 | 09-1559 | 113 | 10-0127 | 383 | 10-0461 | 393 |
| 09-0954 | 120 | 09-1574 | 114 | 10-0130 | 384 | 10-0464 | 393 |
| 09-0955 | 120 | 09-1576 | 114 | 10-0132 | 385 | 10-0465 | 393 |
| 09-0956 | 120 | 09-1581 | 114 | 10-0135 | 385 | 10-0466 | 395 |
| 09-0957 | 120 | 09-1586 | 114 | 10-0138 | 385 | 10-0467 | 395 |
| 09-0958 | 120 | 09-1591 | 114 | 10-0140 | 384 | 10-0468 | 395 |
| 09-0959 | 120 | 09-1710 | 114 | 10-0143 | 385 | 10-0469 | 395 |
| 09-0968 | 121 | 09-1740 | 114 | 10-0145 | 385 | 10-0470 | 395 |
| 09-0969 | 121 | 09-1741 | 114 | 10-0150 | 385 | 10-0471 | 395 |
| 09-0971 | 121 | 09-1800 | 115 | 10-0155 | 385 | 10-0475 | 396 |
| 09-0972 | 121 | 09-1802 | 115 | 10-0160 | 385 | 10-0476 | 396 |
| 09-0974 | 121 | 09-1804 | 115 | 10-0166 | 384 | 10-0482 | 396 |
| 09-0975 | 121 | 09-1880 | 151 | 10-0168 | 403 | 10-0483 | 396 |
| 09-0980 | 151 | 09-1881 | 151 | 10-0168 | 403 | 10-0488 | 397 |
| 09-0981 | 121 | 09-3000 | 122 | 10-0170 | 388 | 10-0489 | 397 |
| 09-0982 | 121 | 09-3006 | 122 | 10-0188 | 452 | 10-0489 | 397 |
| 09-0984 | 121 | 09-3006 | 122 | 10-0190 | 386 | 10-0490 | 400 |
| 09-0984 | 121 | 09-3007 | 122 | 10-0193 | 386 | 10-0562 | 401 |
| 09-0985 | 121 | 09-3010 | 122 | 10-0195 | 386 | 10-0563 | 401 |
| 09-0988 | 151 | 09-3030 | 123 | 10-0200 | 386 | 10-0565 | 401 |
| 09-0990 | 152 | 09-3031 | 123 | 10-0201 | 149 | 10-0566 | 400 |
| 09-0994 | 152 | 09-3032 | 123 | 10-0203 | 149 | 10-0567 | 400 |
| 09-1050 | 116 | 09-3033 | 123 | 10-0220 | 389 | 10-0622 | 402 |
| 09-1051 | 116 | 09-3034 | 123 | 10-0221 | 389 | 10-0623 | 402 |
| 09-1060 | 116 | 09-3035 | 123 | 10-0222 | 389 | 10-0624 | 402 |
| 09-1061 | 116 | 09-3036 | 123 | 10-0223 | 389 | 10-0625 | 402 |
| 09-1070 | 116 | 09-3037 | 123 | 10-0240 | 389 | 10-0630 | 402 |
| 09-1071 | 116 | 09-3052 | 123 | 10-0241 | 389 | 10-0640 | 402 |
| 09-1100 | 117 | 09-3053 | 123 | 10-0245 | 389 | 10-0648 | 403 |
| 09-1102 | 117 | 09-3054 | 123 | 10-0246 | 389 | 10-0660 | 398 |
| 09-1104 | 117 | 09-3055 | 123 | 10-0250 | 389 | 10-0670 | 399 |
| 09-1106 | 117 | 09-3056 | 123 | 10-0251 | 389 | 10-0671 | 399 |
| 09-1110 | 117 | 09-3057 | 123 | 10-0410 | 394 | 10-0700 | 404 |
| 09-1112 | 117 | 09-3062 | 124 | 10-0411 | 394 | 10-0701 | 404 |
| 09-1116 | 115 | 09-3064 | 124 | 10-0412 | 394 | 10-0702 | 404 |
| 09-1118 | 117 | 09-3066 | 124 | 10-0413 | 394 | 10-0710 | 404 |
| 09-1120 | 117 | 09-3132 | 124 | 10-0414 | 394 | 10-0711 | 404 |
| 09-1121 | 115 | 09-3134 | 124 | 10-0415 | 394 | 10-0712 | 404 |
| 09-1122 | 117 | 09-3136 | 124 | 10-0420 | 391 | 10-0713 | 404 |
| 09-1126 | 115 | 09-3142 | 124 | 10-0421 | 391 | 10-0714 | 404 |
| 09-1131 | 115 | 09-3144 | 124 | 10-0422 | 391 | 10-0715 | 404 |
| 09-1136 | 115 | 09-3146 | 124 | 10-0423 | 391 | 10-0716 | 404 |
| 09-1141 | 115 | 09-3172 | 124 | 10-0426 | 392 | 10-0717 | 404 |
| 09-1145 | 115 | 09-3174 | 124 | 10-0427 | 392 | 10-0718 | 404 |
| 09-1161 | 118 | 09-3176 | 124 | 10-0428 | 392 | 10-0790 | 390 |
| 09-1168 | 118 | 09-3182 | 124 | 10-0429 | 392 | 10-0792 | 390 |
| 09-1171 | 118 | 09-3184 | 124 | 10-0436 | 391 | 10-0849 | 403 |
| 09-1176 | 118 | 09-3186 | 124 | 10-0437 | 391 | 10-0850 | 403 |
| 09-1181 | 118 | | | 10-0438 | 390 | 10-0855 | 403 |

Nummernverzeichnis

Index of Numbers

Indice de números de referencias

Index des numéros de références

Indice dei codici

LAWTON
Medizintechnik

| Kat. -Nr. | Seite | Kat. -Nr. | Seite | Kat. -Nr. | Seite | Kat. -Nr. | Seite |
|------------------|--------------|------------------|--------------|------------------|--------------|------------------|--------------|
| Cat. No. | Page | Cat. No. | Page | Cat. No. | Page | Cat. No. | Page |
| Núm. Ref. | Página | Núm. Ref. | Página | Núm. Ref. | Page | Núm. Ref. | Página |
| No. Réf. | Page | No. Réf. | Page | No. Réf. | Page | No. Réf. | Page |
| No. Cat. | Página | No. Cat. | Página | No. Cat. | Página | No. Cat. | Página |
| 10-0860 | 403 | 11-0431 | 189 | 15-0344 | 312 | 16-0270 | 327 |
| 10-1146 | 388 | 11-0480 | 387 | 15-0345 | 312 | 16-0271 | 327 |
| 10-1151 | 388 | 11-0610 | 318 | 15-0346 | 312 | 16-0272 | 327 |
| 10-1156 | 388 | 11-0612 | 318 | 15-0347 | 312 | 16-0273 | 327 |
| 10-1195 | 388 | 11-0614 | 318 | 15-0348 | 312 | 16-0274 | 325 |
| | | 11-0616 | 318 | 15-0349 | 312 | 16-0275 | 325 |
| | | 11-0618 | 318 | 15-0350 | 312 | 16-0276 | 325 |
| 11 | | | | 15-0504 | 313 | 16-0276 | 326 |
| 11-0100 | 415 | 12 | | 15-0505 | 313 | 16-0277 | 326 |
| 11-0110 | 415 | 12-0175 | 728 | 15-0506 | 313 | 16-0279 | 325 |
| 11-0115 | 415 | 12-0200 | 378 | 15-0507 | 313 | 16-0284 | 325 |
| 11-0120 | 415 | 12-0201 | 378 | 15-0508 | 313 | 16-0289 | 326 |
| 11-0139 | 416 | 12-0201 | 378 | 15-0508 | 313 | 16-0291 | 326 |
| 11-0140 | 416 | 12-0275 | 454 | 15-0550 | 313 | 16-0292 | 326 |
| 11-0141 | 416 | 12-0300 | 226 | 15-0551 | 313 | 16-0293 | 326 |
| 11-0142 | 416 | 12-0301 | 226 | 15-0552 | 313 | 16-0293 | 326 |
| 11-0143 | 416 | 12-0310 | 226 | 15-0555 | 313 | 16-0294 | 326 |
| 11-0144 | 416 | 12-0311 | 226 | 15-0557 | 313 | 16-0296 | 326 |
| 11-0145 | 416 | 12-0330 | 243 | 15-0560 | 313 | 16-0300 | 23 |
| 11-0146 | 416 | 12-0340 | 224 | 15-0575 | 313 | 16-0305 | 23 |
| 11-0147 | 416 | 12-0350 | 227 | 15-0576 | 313 | 16-0306 | 457 |
| 11-0148 | 416 | 12-0352 | 227 | 15-0577 | 313 | 16-0320 | 23 |
| 11-0149 | 416 | 12-0354 | 227 | 15-0578 | 313 | 16-0325 | 23 |
| 11-0170 | 416 | 12-0355 | 227 | 15-0579 | 313 | 16-0338 | 23 |
| 11-0171 | 416 | 12-0410 | 280 | 15-0601 | 315 | 16-0340 | 23 |
| 11-0172 | 416 | | | 15-0602 | 315 | 16-0380 | 32 |
| 11-0173 | 416 | 15 | | 15-0603 | 315 | 16-0381 | 32 |
| 11-0174 | 416 | 15-0203 | 314 | 15-0604 | 315 | 16-0382 | 32 |
| 11-0175 | 416 | 15-0204 | 314 | 15-0605 | 315 | | |
| 11-0176 | 416 | 15-0205 | 314 | 15-0606 | 315 | 17 | |
| 11-0177 | 416 | 15-0206 | 314 | 15-0607 | 315 | 17-0110 | 318 |
| 11-0178 | 416 | 15-0214 | 314 | 15-0608 | 315 | 17-0115 | 318 |
| 11-0179 | 416 | 15-0215 | 314 | 15-0609 | 315 | 17-0170 | 318 |
| 11-0180 | 416 | 15-0216 | 314 | 15-0610 | 315 | | |
| 11-0181 | 416 | 15-0223 | 314 | 15-0635 | 315 | 18 | |
| 11-0182 | 416 | 15-0225 | 314 | 15-0636 | 315 | 18-0100 | 3 |
| 11-0183 | 416 | 15-0230 | 314 | 15-0637 | 315 | 18-0103 | 2 |
| 11-0186 | 416 | 15-0231 | 314 | 15-0638 | 315 | 18-0104 | 2 |
| 11-0200 | 417 | 15-0232 | 314 | 15-0639 | 315 | 18-0105 | 3 |
| 11-0230 | 417 | 15-0233 | 314 | 15-0640 | 315 | 18-0106 | 3 |
| 11-0231 | 417 | 15-0304 | 313 | 15-0792 | 317 | 18-0110 | 2 |
| 11-0232 | 417 | 15-0305 | 313 | 15-0793 | 317 | 18-0115 | 2 |
| 11-0233 | 417 | 15-0306 | 313 | | | 18-0117 | 2 |
| 11-0234 | 417 | 15-0307 | 313 | 16 | | 18-0130 | 4 |
| 11-0235 | 417 | 15-0308 | 313 | 16-0200 | 324 | 18-0132 | 4 |
| 11-0236 | 417 | 15-0310 | 313 | 16-0202 | 324 | 18-0134 | 4 |
| 11-0237 | 417 | 15-0315 | 312 | 16-0204 | 324 | 18-0140 | 7 |
| 11-0240 | 417 | 15-0316 | 312 | 16-0210 | 324 | 18-0147 | 7 |
| 11-0265 | 415 | 15-0317 | 312 | 16-0212 | 324 | 18-0148 | 7 |
| 11-0300 | 419 | 15-0318 | 312 | 16-0214 | 324 | 18-0150 | 6 |
| 11-0301 | 419 | 15-0319 | 312 | 16-0216 | 324 | 18-0155 | 6 |
| 11-0305 | 419 | 15-0335 | 312 | 16-0250 | 325 | 18-0158 | 6 |
| 11-0309 | 418 | 15-0336 | 312 | 16-0255 | 325 | 18-0160 | 6 |
| 11-0310 | 418 | 15-0337 | 312 | 16-0265 | 325 | 18-0161 | 6 |
| 11-0314 | 418 | 15-0338 | 312 | 16-0267 | 327 | 18-0162 | 6 |
| 11-0315 | 418 | 15-0339 | 312 | 16-0268 | 327 | 18-0163 | 6 |
| 11-0420 | 189 | 15-0340 | 312 | 16-0269 | 327 | 18-0164 | 6 |

Nummernverzeichnis

Index of Numbers

Índice de números de referencias

Index des numéros de références

Indice dei codici

| Kat. -Nr. | Seite | Kat. -Nr. | Seite | Kat. -Nr. | Seite | Kat. -Nr. | Seite |
|------------------|--------------|------------------|--------------|------------------|--------------|------------------|--------------|
| Cat. No. | Page | Cat. No. | Page | Cat. No. | Page | Cat. No. | Page |
| Núm. Ref. | Página | Núm. Ref. | Página | Núm. Ref. | Página | Núm. Ref. | Página |
| No. Réf. | Page | No. Réf. | Page | No. Réf. | Page | No. Réf. | Page |
| No. Cat. | Pagina | No. Cat. | Pagina | No. Cat. | Pagina | No. Cat. | Pagina |
| 18-0165 | 6 | 18-0522 | 334 | 19-0358 | 17 | 20-0211 | 220 |
| 18-0167 | 7 | 18-0523 | 334 | 19-0360 | 17 | 20-0212 | 220 |
| 18-0170 | 5 | 18-0524 | 334 | 19-0399 | 16 | 20-0213 | 220 |
| 18-0190 | 5 | 18-0525 | 334 | 19-0400 | 16 | 20-0214 | 220 |
| 18-0191 | 5 | 18-0530 | 334 | 19-0402 | 16 | 20-0220 | 232 |
| 18-0200 | 10 | 18-0531 | 334 | 19-0403 | 16 | 20-0221 | 233 |
| 18-0210 | 10 | 18-0532 | 334 | 19-0410 | 18 | 20-0222 | 233 |
| 18-0211 | 10 | 18-0533 | 334 | 19-0460 | 16 | 20-0223 | 233 |
| 18-0213 | 10 | 18-0534 | 334 | 19-0467 | 645 | 20-0224 | 233 |
| 18-0220 | 10 | 18-0535 | 334 | 19-0470 | 645 | 20-0230 | 232 |
| 18-0221 | 10 | 18-0540 | 334 | 19-0483 | 16 | 20-0231 | 233 |
| 18-0241 | 8 | 18-0541 | 334 | 19-0487 | 16 | 20-0232 | 233 |
| 18-0243 | 8 | 18-0542 | 334 | 19-0517 | 18 | 20-0233 | 233 |
| 18-0244 | 8 | 18-0543 | 334 | 19-0521 | 18 | 20-0234 | 233 |
| 18-0245 | 8 | 18-0544 | 334 | 19-0522 | 18 | 20-0251 | 219 |
| 18-0246 | 8 | 18-0545 | 334 | 19-0530 | 18 | 20-0252 | 219 |
| 18-0247 | 8 | | | | | 20-0253 | 219 |
| 18-0250 | 9 | 19 | | 20 | | 20-0254 | 219 |
| 18-0252 | 9 | 19-0100 | 19 | 20-0100 | 218 | 20-0261 | 219 |
| 18-0255 | 9 | 19-0101 | 19 | 20-0101 | 218 | 20-0262 | 219 |
| 18-0257 | 9 | 19-0110 | 19 | 20-0102 | 224 | 20-0263 | 219 |
| 18-0260 | 9 | 19-0120 | 19 | 20-0103 | 224 | 20-0264 | 219 |
| 18-0301 | 11 | 19-0125 | 19 | 20-0105 | 218 | 20-0272 | 235 |
| 18-0303 | 11 | 19-0130 | 19 | 20-0106 | 224 | 20-0273 | 235 |
| 18-0304 | 11 | 19-0135 | 19 | 20-0107 | 224 | 20-0274 | 235 |
| 18-0305 | 11 | 19-0140 | 645 | 20-0108 | 224 | 20-0276 | 235 |
| 18-0307 | 11 | 19-0141 | 645 | 20-0109 | 224 | 20-0280 | 232 |
| 18-0308 | 11 | 19-0145 | 645 | 20-0110 | 224 | 20-0281 | 232 |
| 18-0325 | 11 | 19-0146 | 645 | 20-0111 | 224 | 20-0282 | 235 |
| 18-0335 | 11 | 19-0160 | 645 | 20-0112 | 224 | 20-0283 | 235 |
| 18-0407 | 328 | 19-0161 | 645 | 20-0114 | 225 | 20-0284 | 235 |
| 18-0408 | 328 | 19-0162 | 645 | 20-0115 | 225 | 20-0286 | 235 |
| 18-0409 | 328 | 19-0163 | 645 | 20-0120 | 221 | 20-0290 | 232 |
| 18-0420 | 329 | 19-0202 | 20 | 20-0132 | 225 | 20-0292 | 235 |
| 18-0420 | 518 | 19-0203 | 20 | 20-0133 | 225 | 20-0293 | 235 |
| 18-0421 | 329 | 19-0204 | 20 | 20-0134 | 225 | 20-0294 | 235 |
| 18-0421 | 518 | 19-0205 | 20 | 20-0135 | 225 | 20-0296 | 235 |
| 18-0422 | 328 | 19-0206 | 20 | 20-0136 | 225 | 20-0300 | 232 |
| 18-0423 | 328 | 19-0207 | 20 | 20-0137 | 225 | 20-0302 | 234 |
| 18-0424 | 328 | 19-0208 | 20 | 20-0171 | 219 | 20-0303 | 234 |
| 18-0425 | 328 | 19-0210 | 20 | 20-0172 | 219 | 20-0304 | 234 |
| 18-0426 | 328 | 19-0230 | 19 | 20-0176 | 225 | 20-0306 | 234 |
| 18-0427 | 328 | 19-0250 | 20 | 20-0177 | 225 | 20-0308 | 234 |
| 18-0428 | 328 | 19-0251 | 20 | 20-0179 | 225 | 20-0310 | 232 |
| 18-0481 | 329 | 19-0252 | 20 | 20-0191 | 220 | 20-0312 | 234 |
| 18-0482 | 329 | 19-0253 | 20 | 20-0192 | 220 | 20-0313 | 234 |
| 18-0483 | 329 | 19-0260 | 20 | 20-0193 | 220 | 20-0314 | 234 |
| 18-0484 | 329 | 19-0261 | 20 | 20-0194 | 220 | 20-0316 | 234 |
| 18-0485 | 329 | 19-0262 | 20 | 20-0195 | 220 | 20-0318 | 234 |
| 18-0486 | 329 | 19-0300 | 17 | 20-0196 | 220 | 20-0352 | 234 |
| 18-0487 | 329 | 19-0302 | 17 | 20-0197 | 220 | 20-0353 | 234 |
| 18-0488 | 329 | 19-0305 | 17 | 20-0198 | 220 | 20-0354 | 234 |
| 18-0490 | 329 | 19-0307 | 17 | 20-0201 | 220 | 20-0356 | 234 |
| 18-0491 | 329 | 19-0310 | 17 | 20-0202 | 220 | 20-0402 | 227 |
| 18-0520 | 334 | 19-0315 | 17 | 20-0203 | 220 | 20-0406 | 229 |
| 18-0521 | 334 | 19-0325 | 17 | 20-0204 | 220 | 20-0410 | 229 |

Nummernverzeichnis

Index of Numbers

Indice de números de referencias

Index des numéros de références

Indice dei codici

LAWTON
Medizintechnik

| Kat. -Nr. | Seite | Kat. -Nr. | Seite | Kat. -Nr. | Seite | Kat. -Nr. | Seite |
|------------------|--------------|------------------|--------------|------------------|--------------|------------------|--------------|
| Cat. No. | Page | Cat. No. | Page | Cat. No. | Page | Cat. No. | Page |
| Núm. Ref. | Página | Núm. Ref. | Página | Núm. Ref. | Page | Núm. Ref. | Página |
| No. Réf. | Page | No. Réf. | Page | No. Réf. | Page | No. Réf. | Page |
| No. Cat. | Página | No. Cat. | Página | No. Cat. | Página | No. Cat. | Página |
| 20-0411 | 229 | 20-0586 | 242 | 20-0721 | 251 | 20-0920 | 267 |
| 20-0412 | 229 | 20-0587 | 242 | 20-0722 | 251 | 20-0921 | 267 |
| 20-0413 | 229 | 20-0589 | 242 | 20-0723 | 251 | 20-0922 | 267 |
| 20-0415 | 228 | 20-0607 | 244 | 20-0731 | 250 | 20-0930 | 255 |
| 20-0420 | 231 | 20-0608 | 244 | 20-0732 | 250 | 20-0931 | 255 |
| 20-0424 | 231 | 20-0614 | 244 | 20-0733 | 250 | 20-0932 | 255 |
| 20-0430 | 227 | 20-0615 | 244 | 20-0734 | 250 | 20-0933 | 255 |
| 20-0431 | 227 | 20-0616 | 244 | 20-0735 | 250 | 20-0940 | 255 |
| 20-0440 | 230 | 20-0617 | 244 | 20-0742 | 252 | 20-0941 | 255 |
| 20-0442 | 230 | 20-0618 | 244 | 20-0743 | 252 | 20-0990 | 258 |
| 20-0444 | 230 | 20-0619 | 244 | 20-0744 | 252 | 20-0991 | 258 |
| 20-0460 | 228 | 20-0620 | 244 | 20-0745 | 252 | 20-0992 | 258 |
| 20-0465 | 228 | 20-0624 | 243 | 20-0746 | 252 | 20-0995 | 259 |
| 20-0470 | 228 | 20-0625 | 243 | 20-0747 | 252 | 20-0996 | 259 |
| 20-0490 | 229 | 20-0626 | 243 | 20-0748 | 252 | 20-0997 | 259 |
| 20-0495 | 223 | 20-0627 | 243 | 20-0750 | 236 | 20-0999 | 259 |
| 20-0507 | 241 | 20-0628 | 243 | 20-0751 | 236 | 20-1010 | 309 |
| 20-0508 | 241 | 20-0629 | 243 | 20-0753 | 236 | 20-1011 | 309 |
| 20-0509 | 241 | 20-0635 | 244 | 20-0754 | 236 | 20-1013 | 309 |
| 20-0510 | 241 | 20-0636 | 245 | 20-0760 | 236 | 20-1015 | 309 |
| 20-0511 | 241 | 20-0637 | 245 | 20-0774 | 237 | 20-1016 | 309 |
| 20-0512 | 241 | 20-0638 | 245 | 20-0775 | 237 | 20-1017 | 309 |
| 20-0514 | 241 | 20-0641 | 242 | 20-0776 | 237 | 20-1018 | 309 |
| 20-0515 | 241 | 20-0642 | 242 | 20-0777 | 237 | 20-1019 | 309 |
| 20-0516 | 241 | 20-0643 | 242 | 20-0792 | 253 | 20-1730 | 249 |
| 20-0517 | 241 | 20-0644 | 246 | 20-0793 | 253 | 20-1792 | 263 |
| 20-0518 | 241 | 20-0645 | 246 | 20-0794 | 253 | 20-1816 | 265 |
| 20-0519 | 241 | 20-0646 | 246 | 20-0795 | 253 | 20-1831 | 265 |
| 20-0530 | 238 | 20-0647 | 246 | 20-0796 | 253 | 20-1836 | 265 |
| 20-0531 | 238 | 20-0648 | 246 | 20-0797 | 253 | 20-1841 | 265 |
| 20-0532 | 238 | 20-0649 | 246 | 20-0803 | 264 | 20-1862 | 256 |
| 20-0533 | 238 | 20-0650 | 247 | 20-0804 | 264 | 20-1864 | 256 |
| 20-0534 | 238 | 20-0651 | 247 | 20-0805 | 264 | 20-1866 | 256 |
| 20-0535 | 238 | 20-0652 | 247 | 20-0806 | 264 | 20-1872 | 263 |
| 20-0536 | 238 | 20-0655 | 247 | 20-0807 | 264 | 20-1877 | 262 |
| 20-0551 | 238 | 20-0656 | 247 | 20-0808 | 264 | 20-1878 | 262 |
| 20-0552 | 238 | 20-0659 | 247 | 20-0809 | 265 | 20-2862 | 257 |
| 20-0553 | 238 | 20-0665 | 249 | 20-0810 | 264 | 20-2864 | 257 |
| 20-0555 | 238 | 20-0680 | 248 | 20-0811 | 265 | 20-2866 | 257 |
| 20-0556 | 238 | 20-0681 | 248 | 20-0812 | 265 | 20-2868 | 257 |
| 20-0557 | 239 | 20-0682 | 248 | 20-0847 | 266 | 20-2869 | 257 |
| 20-0558 | 239 | 20-0683 | 248 | 20-0848 | 266 | | |
| 20-0559 | 239 | 20-0684 | 248 | 20-0849 | 266 | 21 | |
| 20-0561 | 238 | 20-0685 | 248 | 20-0850 | 266 | 21-0128 | 271 |
| 20-0562 | 238 | 20-0686 | 248 | 20-0852 | 266 | 21-0147 | 270 |
| 20-0570 | 240 | 20-0687 | 248 | 20-0853 | 266 | 21-0148 | 270 |
| 20-0571 | 240 | 20-0688 | 248 | 20-0855 | 266 | 21-0149 | 270 |
| 20-0572 | 240 | 20-0689 | 248 | 20-0860 | 266 | 21-0150 | 270 |
| 20-0573 | 240 | 20-0699 | 248 | 20-0861 | 266 | 21-0151 | 270 |
| 20-0574 | 240 | 20-0705 | 251 | 20-0862 | 266 | 21-0152 | 270 |
| 20-0575 | 240 | 20-0708 | 250 | 20-0865 | 266 | 21-0153 | 270 |
| 20-0581 | 240 | 20-0709 | 250 | 20-0871 | 267 | 21-0155 | 270 |
| 20-0582 | 240 | 20-0710 | 250 | 20-0873 | 267 | 21-0156 | 270 |
| 20-0583 | 240 | 20-0711 | 251 | 20-0874 | 267 | 21-0157 | 270 |
| 20-0584 | 242 | 20-0712 | 251 | 20-0880 | 262 | 21-0158 | 270 |
| 20-0585 | 242 | 20-0713 | 251 | 20-0881 | 262 | 21-0159 | 270 |

| Kat. -Nr. | Seite | Kat. -Nr. | Seite | Kat. -Nr. | Seite | Kat. -Nr. | Seite |
|------------------|--------------|------------------|--------------|------------------|--------------|------------------|--------------|
| Cat. No. | Page | Cat. No. | Page | Cat. No. | Page | Cat. No. | Page |
| Núm. Ref. | Página | Núm. Ref. | Página | Núm. Ref. | Página | Núm. Ref. | Página |
| No. Réf. | Page | No. Réf. | Page | No. Réf. | Page | No. Réf. | Page |
| No. Cat. | Pagina | No. Cat. | Pagina | No. Cat. | Pagina | No. Cat. | Pagina |
| 21-0170 | 271 | 21-0352 | 297 | 21-0502 | 301 | 22-0610 | 174 |
| 21-0172 | 271 | 21-0356 | 297 | 21-0503 | 301 | 22-0611 | 174 |
| 21-0174 | 271 | 21-0357 | 297 | 21-0505 | 301 | 22-0612 | 174 |
| 21-0176 | 271 | 21-0358 | 297 | 21-0507 | 300 | 22-0613 | 174 |
| 21-0179 | 271 | 21-0361 | 298 | 21-0507 | 301 | 22-0910 | 129 |
| 21-0195 | 272 | 21-0362 | 298 | 21-0509 | 301 | 22-0911 | 140 |
| 21-0196 | 272 | 21-0365 | 283 | 21-0510 | 301 | 22-0912 | 129 |
| 21-0200 | 272 | 21-0366 | 283 | 21-0512 | 301 | | |
| 21-0205 | 273 | 21-0367 | 283 | 21-0550 | 304 | 23 | |
| 21-0210 | 273 | 21-0368 | 283 | 21-0552 | 304 | 23-1800 | 521 |
| 21-0215 | 274 | 21-0369 | 283 | 21-0553 | 304 | 23-1802 | 520 |
| 21-0216 | 274 | 21-0374 | 283 | 21-0554 | 304 | 23-1804 | 520 |
| 21-0217 | 274 | 21-0378 | 297 | 21-0556 | 305 | 23-1806 | 520 |
| 21-0220 | 272 | 21-0379 | 297 | 21-0557 | 305 | 23-1808 | 520 |
| 21-0225 | 273 | 21-0380 | 298 | 21-0558 | 305 | 23-1810 | 521 |
| 21-0230 | 273 | 21-0381 | 298 | 21-0559 | 305 | 23-1812 | 520 |
| 21-0235 | 274 | 21-0382 | 297 | 21-0560 | 305 | 23-1814 | 520 |
| 21-0240 | 278 | 21-0383 | 297 | 21-0562 | 305 | 23-1816 | 520 |
| 21-0241 | 278 | 21-0384 | 298 | 21-0563 | 305 | 23-1818 | 520 |
| 21-0242 | 278 | 21-0387 | 298 | 21-0564 | 305 | 23-1820 | 521 |
| 21-0243 | 278 | 21-0388 | 298 | 21-0564 | 305 | 23-1820 | 521 |
| 21-0245 | 278 | 21-0388 | 298 | 21-0565 | 305 | 23-1830 | 521 |
| 21-0246 | 278 | 21-0389 | 298 | 21-0566 | 305 | 23-1840 | 521 |
| 21-0252 | 280 | 21-0396 | 298 | 21-0566 | 305 | 23-1840 | 521 |
| 21-0260 | 273 | 21-0397 | 298 | 21-0567 | 305 | 23-1850 | 524 |
| 21-0261 | 276 | 21-0398 | 298 | 21-0568 | 305 | 23-1852 | 524 |
| 21-0263 | 273 | 21-0398 | 298 | 21-0570 | 306 | 23-1860 | 522 |
| 21-0266 | 276 | 21-0399 | 298 | 21-0571 | 307 | 23-1861 | 522 |
| 21-0267 | 277 | 21-0401 | 284 | 21-0572 | 307 | 23-1862 | 522 |
| 21-0268 | 277 | 21-0402 | 284 | 21-0573 | 307 | 23-1863 | 522 |
| 21-0270 | 275 | 21-0403 | 284 | 21-0574 | 307 | 23-1864 | 522 |
| 21-0271 | 275 | 21-0420 | 299 | 21-0574 | 307 | 23-1864 | 522 |
| 21-0280 | 275 | 21-0420 | 299 | 21-0575 | 306 | 23-1865 | 522 |
| 21-0281 | 275 | 21-0425 | 299 | 21-0576 | 307 | 23-1866 | 522 |
| 21-0282 | 275 | 21-0426 | 300 | 21-0576 | 307 | 23-1866 | 522 |
| 21-0282 | 275 | 21-0427 | 300 | 21-0577 | 307 | 23-1867 | 522 |
| 21-0283 | 275 | 21-0428 | 300 | 21-0578 | 307 | 23-1868 | 522 |
| 21-0300 | 281 | 21-0428 | 300 | 21-0579 | 306 | 23-1870 | 522 |
| 21-0301 | 281 | 21-0429 | 300 | 21-0581 | 306 | 23-1871 | 522 |
| 21-0305 | 281 | 21-0430 | 302 | 21-0584 | 306 | 23-1872 | 522 |
| 21-0306 | 281 | 21-0431 | 302 | 21-0585 | 306 | 23-1873 | 522 |
| 21-0310 | 284 | 21-0432 | 302 | 21-0587 | 307 | 23-1874 | 522 |
| 21-0311 | 284 | 21-0435 | 302 | 21-0588 | 307 | 23-1875 | 522 |
| 21-0320 | 284 | 21-0436 | 302 | 21-0620 | 304 | 23-1876 | 522 |
| 21-0325 | 282 | 21-0441 | 303 | 21-0621 | 304 | 23-1877 | 522 |
| 21-0326 | 282 | 21-0442 | 303 | 21-0622 | 304 | 23-1878 | 522 |
| 21-0327 | 283 | 21-0443 | 303 | 21-0623 | 304 | 23-1880 | 523 |
| 21-0328 | 283 | 21-0444 | 303 | 21-0624 | 304 | 23-1881 | 523 |
| 21-0329 | 283 | 21-0445 | 303 | 21-0625 | 304 | 23-1882 | 523 |
| 21-0335 | 282 | 21-0446 | 303 | 21-0650 | 308 | 23-1883 | 523 |
| 21-0336 | 282 | 21-0447 | 303 | 21-0651 | 308 | 23-1884 | 523 |
| 21-0340 | 297 | 21-0448 | 303 | 21-0652 | 308 | 23-1885 | 523 |
| 21-0341 | 297 | 21-0449 | 303 | 21-0653 | 308 | 23-1886 | 523 |
| 21-0345 | 297 | 21-0465 | 299 | 21-0654 | 308 | 23-1887 | 523 |
| 21-0346 | 297 | 21-0470 | 299 | | | 23-1888 | 523 |
| 21-0350 | 297 | 21-0471 | 299 | 22 | | 23-1890 | 523 |
| 21-0351 | 297 | 21-0472 | 299 | 22-0600 | 174 | 23-1891 | 523 |
| | | 21-0473 | 299 | 22-0601 | 174 | 23-1892 | 523 |
| | | 21-0500 | 300 | 22-0602 | 174 | 23-1893 | 523 |
| | | 21-0501 | 300 | 22-0603 | 174 | 23-1894 | 523 |

Nummernverzeichnis

Index of Numbers

Índice de números de referencias

Index des numéros de références

Indice dei codici

LAWTON
Medizintechnik

Kat. -Nr. Seite
Cat. No. Page
Núm. Ref. Página
No. Réf. Page
No. Cat. Pagina

23-1895 523
23-1896 523
23-1897 523
23-1898 523
23-1900 559
23-1905 559
23-1910 559
23-1911 555
23-1912 555
23-1913 555
23-1914 555
23-1915 555
23-1916 555
23-1917 555
23-1918 555
23-1925 556
23-1930 556
23-1935 556
23-1950 559
23-1955 559
23-1960 559
23-1965 559
23-1976 560
23-2000 556
23-2005 556
23-2025 557
23-2030 557
23-2035 557
23-2036 557
23-2037 537
23-2038 537
23-2050 560
23-2055 560
23-2075 560
23-2080 560
23-2085 560
23-2090 558
23-2091 558
23-2092 558
23-2520 531
23-2521 531
23-2522 532
23-2523 532
23-2524 532
23-2528 543
23-2529 543
23-2530 543
23-2535 530
23-2537 530
23-2539 530
23-2550 537
23-2555 532
23-2565 542
23-2566 542
23-2567 542
23-2580 542

Kat. -Nr. Seite
Cat. No. Page
Núm. Ref. Página
No. Réf. Page
No. Cat. Pagina

23-2581 542
23-2585 542
23-2586 542
23-2590 543
23-2591 543
23-2593 543
25
25-0210 359
25-0211 359
25-0212 359
25-0213 359
25-0216 359
25-0217 359
25-0218 359
25-0219 359
25-0275 339
25-0276 339
25-0277 339
25-0278 339
25-0294 338
25-0296 338
25-0297 338
25-0299 338
25-0320 359
25-0321 359
25-0322 359
25-0323 359
25-0326 359
25-0327 359
25-0328 359
25-0329 359
25-0330 64
25-0331 64
25-0335 64
25-0336 64
25-0337 64
25-0338 64
25-0339 64
25-0420 361
25-0421 361
25-0422 361
25-0423 361
25-0424 361
25-0425 361
25-0426 361
25-0427 361
25-0428 361
25-0429 361
25-0430 361
25-0431 361
25-0432 361
25-0433 361
25-0434 361
25-0435 361
25-0436 361

Kat. -Nr. Seite
Cat. No. Page
Núm. Ref. Página
No. Réf. Page
No. Cat. Pagina

25-0437 361
25-0438 361
25-0439 361
25-0461 362
25-0462 362
25-0463 362
25-0466 362
25-0467 362
25-0468 362
25-0471 362
25-0472 362
25-0473 362
25-0476 362
25-0477 362
25-0478 362
30
30-0010 135
30-0020 135
30-0021 135
30-0022 135
30-0023 135
30-0024 135
30-0030 135
30-0031 135
30-0032 135
30-0033 135
30-0040 222
30-0041 222
30-0042 222
30-0043 222
30-0044 222
30-0045 222
30-0050 135
30-0051 135
30-0055 135
30-0060 135
30-0061 135
30-0065 135
30-0070 135
30-0071 135
30-0075 135
30-0090 222
30-0091 222
30-0092 222
30-0093 222
30-0094 222
30-0095 222
30-0100 217
30-0130 509
30-0131 509
30-0132 509
30-0135 223
30-0136 223
30-0137 223
30-0138 223

Kat. -Nr. Seite
Cat. No. Page
Núm. Ref. Página
No. Réf. Page
No. Cat. Pagina

30-0139 223
30-0160 223
30-0161 223
30-0162 223
30-0163 223
30-0164 223
30-0165 223
30-0185 95
30-0187 95
30-0189 97
30-0190 97
30-0200 96
30-0205 96
30-0208 96
30-0210 96
30-0211 96
30-0212 96
30-0213 96
30-0214 96
30-0216 96
30-0221 96
30-0224 96
30-0227 96
30-0236 97
30-0240 99
30-0247 98
30-0260 99
30-0690 564
30-0693 564
30-0695 564
30-0800 565
30-0801 565
30-0810 565
30-0811 565
30-0960 160
30-0961 161
30-0962 160
30-0963 161
30-0964 160
30-0965 161
30-0966 160
30-0967 161
30-0971 161
30-0973 161
30-0975 161
30-0977 161
30-0980 160
30-0981 161
30-0982 160
30-0983 161
30-0984 160
30-0985 161
30-0986 160
30-0987 161
30-0991 161
30-0993 161

| Kat. -Nr. | Seite | Kat. -Nr. | Seite | Kat. -Nr. | Seite | Kat. -Nr. | Seite |
|------------------|--------------|------------------|--------------|------------------|--------------|------------------|--------------|
| Cat. No. | Page | Cat. No. | Page | Cat. No. | Page | Cat. No. | Page |
| Núm. Ref. | Página | Núm. Ref. | Página | Núm. Ref. | Página | Núm. Ref. | Página |
| No. Réf. | Page | No. Réf. | Page | No. Réf. | Page | No. Réf. | Page |
| No. Cat. | Pagina | No. Cat. | Pagina | No. Cat. | Pagina | No. Cat. | Pagina |
| 30-0995 | 161 | 30-1263 | 530 | 30-1728 | 554 | 30-2154 | 556 |
| 30-0997 | 161 | 30-1267 | 530 | 30-1730 | 554 | 30-2158 | 556 |
| 30-0999 | 160 | 30-1270 | 535 | 30-1732 | 554 | 30-2300 | 557 |
| 30-1000 | 525 | 30-1272 | 535 | 30-1734 | 554 | 30-2303 | 557 |
| 30-1001 | 525 | 30-1274 | 535 | 30-1736 | 554 | 30-2310 | 557 |
| 30-1005 | 525 | 30-1276 | 535 | 30-1738 | 554 | 30-2313 | 557 |
| 30-1006 | 525 | 30-1280 | 536 | 30-1800 | 550 | 30-2335 | 558 |
| 30-1010 | 525 | 30-1282 | 536 | 30-1825 | 541 | 30-2602 | 561 |
| 30-1011 | 525 | 30-1284 | 536 | 30-1826 | 541 | 30-2660 | 562 |
| 30-1015 | 525 | 30-1286 | 536 | 30-1827 | 541 | 30-2662 | 562 |
| 30-1016 | 525 | 30-1291 | 534 | 30-1828 | 541 | 30-2668 | 562 |
| 30-1025 | 525 | 30-1292 | 534 | 30-1829 | 541 | 30-2682 | 562 |
| 30-1026 | 525 | 30-1600 | 547 | 30-1831 | 551 | 30-2684 | 562 |
| 30-1027 | 525 | 30-1602 | 547 | 30-1832 | 551 | 30-2690 | 558 |
| 30-1030 | 525 | 30-1605 | 547 | 30-1870 | 538 | 30-2691 | 558 |
| 30-1100 | 526 | 30-1607 | 547 | 30-1871 | 538 | 30-2695 | 561 |
| 30-1101 | 526 | 30-1610 | 547 | 30-1872 | 538 | | |
| 30-1110 | 526 | 30-1630 | 545 | 30-1873 | 538 | 31 | |
| 30-1111 | 526 | 30-1631 | 545 | 30-1874 | 538 | 31-0600 | 512 |
| 30-1115 | 526 | 30-1632 | 545 | 30-1875 | 538 | 31-0601 | 512 |
| 30-1116 | 526 | 30-1635 | 545 | 30-1876 | 538 | 31-0602 | 512 |
| 30-1120 | 526 | 30-1640 | 545 | 30-1877 | 538 | 31-0603 | 512 |
| 30-1121 | 526 | 30-1642 | 548 | 30-1886 | 550 | 31-0605 | 513 |
| 30-1124 | 527 | 30-1643 | 548 | 30-1887 | 550 | 31-0607 | 513 |
| 30-1125 | 527 | 30-1646 | 539 | 30-1910 | 531 | 31-0608 | 513 |
| 30-1127 | 527 | 30-1648 | 539 | 30-1911 | 531 | 31-0609 | 513 |
| 30-1128 | 527 | 30-1650 | 539 | 30-1915 | 533 | 31-0612 | 512 |
| 30-1130 | 528 | 30-1655 | 549 | 30-1916 | 533 | 31-0615 | 512 |
| 30-1132 | 528 | 30-1656 | 549 | 30-1917 | 533 | 31-0616 | 512 |
| 30-1134 | 528 | 30-1657 | 549 | 30-1918 | 533 | 31-0617 | 512 |
| 30-1136 | 528 | 30-1658 | 549 | 30-1930 | 544 | 31-0618 | 514 |
| 30-1138 | 528 | 30-1660 | 541 | 30-1932 | 544 | 31-0619 | 514 |
| 30-1146 | 537 | 30-1662 | 541 | 30-1940 | 544 | 31-0620 | 514 |
| 30-1148 | 537 | 30-1664 | 541 | 30-1942 | 544 | 31-0622 | 514 |
| 30-1150 | 534 | 30-1666 | 541 | 30-1945 | 544 | 31-0623 | 514 |
| 30-1152 | 534 | 30-1668 | 541 | 30-1947 | 544 | 31-0624 | 514 |
| 30-1154 | 534 | 30-1680 | 553 | 30-1950 | 563 | 31-0626 | 514 |
| 30-1156 | 537 | 30-1682 | 553 | 30-1952 | 563 | 31-0628 | 514 |
| 30-1160 | 529 | 30-1684 | 553 | 30-1954 | 563 | 31-0630 | 514 |
| 30-1161 | 529 | 30-1686 | 553 | 30-1960 | 563 | 31-0632 | 513 |
| 30-1162 | 529 | 30-1690 | 553 | 30-1962 | 563 | 31-0634 | 513 |
| 30-1163 | 529 | 30-1692 | 553 | 30-1964 | 563 | 31-0635 | 514 |
| 30-1164 | 529 | 30-1694 | 553 | 30-2000 | 56 | 31-0660 | 514 |
| 30-1165 | 529 | 30-1696 | 553 | 30-2001 | 56 | 31-0661 | 514 |
| 30-1166 | 529 | 30-1700 | 540 | 30-2002 | 56 | 31-0662 | 514 |
| 30-1167 | 529 | 30-1702 | 540 | 30-2005 | 57 | 31-0665 | 514 |
| 30-1200 | 533 | 30-1704 | 540 | 30-2006 | 57 | 31-0666 | 514 |
| 30-1203 | 533 | 30-1706 | 540 | 30-2007 | 57 | 31-0667 | 514 |
| 30-1210 | 531 | 30-1711 | 546 | 30-2010 | 57 | 31-0668 | 514 |
| 30-1213 | 531 | 30-1713 | 546 | 30-2011 | 57 | 31-0669 | 514 |
| 30-1235 | 534 | 30-1715 | 546 | 30-2012 | 57 | 31-0670 | 514 |
| 30-1240 | 535 | 30-1719 | 546 | 30-2070 | 56 | 31-0671 | 514 |
| 30-1245 | 535 | 30-1720 | 554 | 30-2071 | 56 | 31-0672 | 514 |
| 30-1250 | 535 | 30-1722 | 554 | 30-2072 | 56 | 31-0673 | 514 |
| 30-1258 | 530 | 30-1724 | 554 | 30-2073 | 56 | 31-0674 | 514 |
| 30-1262 | 530 | 30-1726 | 554 | 30-2074 | 56 | 31-0675 | 514 |

Nummernverzeichnis

Index of Numbers

Índice de números de referencias

Index des numéros de références

Indice dei codici

LAWTON
Medizintechnik

Kat. -Nr. Seite
Cat. No. Page
Núm. Ref. Página
No. Réf. Page
No. Cat. Pagina

31-0677 515
31-0680 322
31-0681 322
31-0682 322
31-0683 322
31-0690 515
31-0700 510
31-0701 510
31-0702 510
31-0703 510
31-0704 510
31-0705 510
31-0706 510
31-0707 510
31-0722 510
31-0723 510
31-0724 510
31-0725 510
31-0726 510
31-0727 510
31-0728 510
31-0729 510
31-0730 510
31-0731 510
31-0732 510
31-0733 510
31-0758 511
31-0760 511
31-0870 516
31-0871 516
31-0872 516
31-0873 516
31-0874 516
31-0875 516
31-0876 516
31-0877 516
31-0878 516
31-0879 516
31-0880 516
31-0881 516
31-0882 516
31-0883 516
31-0885 517
31-0886 517
31-0887 517
31-0889 517
31-0895 517
31-0896 517
31-0897 517
31-0898 517

35

35-0460 518
35-0462 518
35-0463 518
35-0465 518

Kat. -Nr. Seite
Cat. No. Page
Núm. Ref. Página
No. Réf. Page
No. Cat. Pagina

35-0466 518
35-0467 518
35-0720 387
35-0820 387
35-0825 387
35-0830 387
35-0835 387
35-0860 386
35-0865 386

36

36-0170 171
36-0200 566
36-0201 566
36-0202 566
36-0250 564
36-0255 564
36-0260 564
36-0321 186
36-0322 186
36-0323 186
36-0324 186
36-0410 566
36-0415 566
36-1310 551
36-1312 551
36-1326 186
36-1327 186
36-1328 186
36-1329 186
36-1360 551
36-1361 551
36-1362 551
36-1363 551
36-1364 551
36-1365 551
36-1370 552
36-1372 552
36-1374 552

37

37-0100 503
37-0110 503
37-0111 503
37-0120 503
37-0121 503
37-0122 503
37-0124 501
37-0125 501
37-0126 501
37-0130 506
37-0137 507
37-0142 500
37-0143 498
37-0144 498
37-0145 499

Kat. -Nr. Seite
Cat. No. Page
Núm. Ref. Página
No. Réf. Page
No. Cat. Pagina

37-0148 499
37-0150 498
37-0152 498
37-0155 499
37-0156 499
37-0157 500
37-0158 500
37-0159 500
37-0160 503
37-0161 503
37-0162 503
37-0170 502
37-0171 502
37-0172 502
37-0183 503
37-0184 502
37-0185 501
37-0186 501
37-0200 504
37-0202 504
37-0204 504
37-0206 504
37-0208 504
37-0210 505
37-0212 505
37-0214 505
37-0215 505
37-0216 505
37-0217 505
37-0218 505
37-0221 506
37-0222 506
37-0230 507
37-0232 507
37-0234 507
37-0236 507
37-0248 508
37-0250 508
37-0255 508
37-0258 508
37-0275 231
37-0276 231
37-0277 231
37-0320 260
37-0321 260
37-0370 260
37-0445 261
37-0446 261
37-0447 261
37-0450 260
37-0455 260

38

38-0099 492
38-0100 492
38-0110 492

Kat. -Nr. Seite
Cat. No. Page
Núm. Ref. Página
No. Réf. Page
No. Cat. Pagina

38-0150 492
38-0198 493
38-0200 492
38-0210 494
38-0220 494
38-0230 493
38-0231 493
38-0255 492
38-0330 493
38-0345 639
38-0350 639
38-0355 639
38-0400 634
38-0405 636
38-0410 634
38-0415 636
38-0425 635
38-0435 633
38-0440 633
38-0441 633
38-0442 634
38-0443 634
38-0450 633
38-0451 633
38-0455 636
38-0460 636
38-0470 638
38-0471 638
38-0500 635
38-0501 635
38-0502 635
38-0503 635
38-0701 494
38-0703 636

39

39-0130 497
39-0165 495
39-0166 495
39-0170 495
39-0171 495
39-0175 495
39-0176 495
39-0192 586
39-0195 586
39-0250 496
39-0252 496
39-0254 496
39-0258 496
39-0262 496
39-0302 497
39-0305 497
39-0500 329
39-0500 518
39-0523 318
39-0524 318

| Kat. -Nr. | Seite | Kat. -Nr. | Seite | Kat. -Nr. | Seite | Kat. -Nr. | Seite |
|------------------|--------------|------------------|--------------|------------------|--------------|------------------|--------------|
| Cat. No. | Page | Cat. No. | Page | Cat. No. | Page | Cat. No. | Page |
| Núm. Ref. | Página | Núm. Ref. | Página | Núm. Ref. | Página | Núm. Ref. | Página |
| No. Réf. | Page | No. Réf. | Page | No. Réf. | Page | No. Réf. | Page |
| No. Cat. | Pagina | No. Cat. | Pagina | No. Cat. | Pagina | No. Cat. | Pagina |
| 42 | | 45-0205 | 630 | 45-0433 | 637 | 45-1102 | 709 |
| 42-0110 | 675 | 45-0208 | 630 | 45-0460 | 633 | 45-1103 | 709 |
| 42-0115 | 675 | 45-0212 | 630 | 45-0462 | 633 | 45-1105 | 709 |
| 42-0118 | 677 | 45-0214 | 630 | 45-0485 | 638 | 45-1106 | 709 |
| 42-0120 | 677 | 45-0216 | 630 | 45-0490 | 638 | 45-1107 | 709 |
| 42-0145 | 678 | 45-0225 | 630 | 45-0491 | 638 | 45-1108 | 709 |
| 42-0147 | 678 | 45-0230 | 629 | 45-0498 | 494 | 45-1110 | 710 |
| 42-0150 | 678 | 45-0231 | 629 | 45-0500 | 633 | 45-1111 | 710 |
| 42-0210 | 679 | 45-0232 | 629 | 45-0502 | 633 | 45-1112 | 710 |
| 42-0232 | 679 | 45-0233 | 629 | 45-0505 | 633 | 45-1113 | 710 |
| 42-0234 | 679 | 45-0234 | 629 | 45-0507 | 634 | 45-1130 | 709 |
| 42-0240 | 679 | 45-0280 | 630 | 45-0509 | 633 | 45-1131 | 709 |
| 42-0245 | 679 | 45-0302 | 576 | 45-0597 | 634 | 45-1132 | 709 |
| 42-0300 | 682 | 45-0304 | 576 | 45-0598 | 634 | 45-1133 | 709 |
| 42-0302 | 682 | 45-0306 | 576 | 45-0599 | 634 | 45-1135 | 709 |
| 42-0315 | 682 | 45-0308 | 576 | 45-0600 | 632 | 45-1136 | 709 |
| 42-0320 | 682 | 45-0310 | 581 | 45-0601 | 632 | 45-1137 | 709 |
| 42-0350 | 680 | 45-0312 | 577 | 45-0605 | 631 | 45-1138 | 709 |
| 42-0351 | 680 | 45-0314 | 577 | 45-0607 | 631 | 45-1140 | 710 |
| 42-0355 | 681 | 45-0316 | 577 | 45-0613 | 632 | 45-1141 | 710 |
| 42-0356 | 681 | 45-0317 | 578 | 45-0628 | 631 | 45-1142 | 710 |
| 42-0357 | 681 | 45-0318 | 580 | 45-0743 | 710 | 45-1143 | 710 |
| 42-0358 | 681 | 45-0319 | 578 | 45-0745 | 710 | 45-1170 | 710 |
| 42-0359 | 681 | 45-0320 | 578 | 45-0753 | 711 | 45-1171 | 710 |
| | | 45-0322 | 578 | 45-0755 | 711 | 45-1172 | 710 |
| 45 | | 45-0323 | 579 | 45-0763 | 711 | 45-1173 | 710 |
| 45-0099 | 624 | 45-0324 | 579 | 45-0765 | 711 | 45-1743 | 710 |
| 45-0100 | 624 | 45-0325 | 579 | 45-0790 | 707 | 45-1745 | 710 |
| 45-0110 | 624 | 45-0326 | 580 | 45-0791 | 707 | 45-1753 | 711 |
| 45-0112 | 627 | 45-0328 | 580 | 45-0792 | 707 | 45-1755 | 711 |
| 45-0114 | 627 | 45-0329 | 580 | 45-0793 | 707 | 45-1763 | 711 |
| 45-0116 | 627 | 45-0330 | 581 | 45-0806 | 712 | 45-1765 | 711 |
| 45-0118 | 627 | 45-0331 | 581 | 45-0807 | 712 | | |
| 45-0123 | 622 | 45-0348 | 623 | 45-0812 | 712 | 46 | |
| 45-0127 | 622 | 45-0349 | 623 | 45-0814 | 712 | 46-0002 | 607 |
| 45-0130 | 622 | 45-0350 | 623 | 45-0815 | 712 | 46-0003 | 607 |
| 45-0131 | 622 | 45-0360 | 641 | 45-0817 | 712 | 46-0004 | 607 |
| 45-0133 | 622 | 45-0362 | 641 | 45-0852 | 713 | 46-0005 | 607 |
| 45-0135 | 622 | 45-0364 | 641 | 45-0853 | 713 | 46-0006 | 607 |
| 45-0136 | 623 | 45-0366 | 641 | 45-0854 | 713 | 46-0007 | 607 |
| 45-0138 | 623 | 45-0368 | 641 | 45-0862 | 713 | 46-0008 | 607 |
| 45-0140 | 623 | 45-0370 | 641 | 45-0863 | 713 | 46-0012 | 607 |
| 45-0150 | 625 | 45-0371 | 641 | 45-0864 | 713 | 46-0013 | 607 |
| 45-0159 | 625 | 45-0375 | 641 | 45-0872 | 713 | 46-0014 | 607 |
| 45-0161 | 625 | 45-0400 | 637 | 45-0873 | 713 | 46-0015 | 607 |
| 45-0175 | 626 | 45-0402 | 637 | 45-0874 | 713 | 46-0016 | 607 |
| 45-0185 | 626 | 45-0404 | 637 | 45-0950 | 720 | 46-0017 | 607 |
| 45-0186 | 626 | 45-0406 | 637 | 45-0951 | 721 | 46-0018 | 607 |
| 45-0187 | 626 | 45-0410 | 637 | 45-0953 | 721 | 46-0020 | 609 |
| 45-0188 | 627 | 45-0412 | 637 | 45-0955 | 721 | 46-0022 | 609 |
| 45-0190 | 628 | 45-0414 | 637 | 45-0956 | 721 | 46-0024 | 609 |
| 45-0191 | 628 | 45-0416 | 637 | 45-0957 | 721 | 46-0026 | 609 |
| 45-0192 | 628 | 45-0428 | 638 | 45-0958 | 721 | 46-0028 | 609 |
| 45-0193 | 628 | 45-0429 | 638 | 45-0959 | 721 | 46-0030 | 609 |
| 45-0201 | 630 | 45-0430 | 637 | 45-1100 | 709 | 46-0032 | 609 |
| 45-0202 | 630 | 45-0431 | 637 | 45-1101 | 709 | 46-0034 | 609 |

Nummernverzeichnis

Index of Numbers

Indice de números de referencias

Index des numéros de références

Indice dei codici

LAWTON
Medizintechnik

Kat. -Nr. Seite
Cat. No. Page
Núm. Ref. Página
No. Réf. Page
No. Cat. Pagina

46-0036 609
46-0038 609
46-0040 609
46-0042 609
46-0044 609
46-0046 609
46-0048 609
46-0050 612
46-0051 612
46-0052 612
46-0053 612
46-0054 612
46-0060 612
46-0061 612
46-0062 612
46-0063 612
46-0064 612
46-0078 606
46-0079 606
46-0080 606
46-0081 606
46-0082 606
46-0083 606
46-0084 606
46-0094 606
46-0095 606
46-0096 606
46-0097 606
46-0098 606
46-0099 606
46-0149 608
46-0150 608
46-0151 608
46-0152 608
46-0153 608
46-0154 608
46-0155 608
46-0157 608
46-0170 608
46-0172 608
46-0174 608
46-0176 608
46-0177 608
46-0178 608
46-0180 608
46-0182 608
46-0184 608
46-0186 608
46-0187 608
46-0188 608
46-0200 610
46-0202 610
46-0205 610
46-0210 610
46-0215 610
46-0225 610

Kat. -Nr. Seite
Cat. No. Page
Núm. Ref. Página
No. Réf. Page
No. Cat. Pagina

46-0227 610
46-0230 610
46-0235 610
46-0240 610
46-0248 610
46-0250 610
46-0252 610
46-0255 610
46-0260 610
46-0265 610
46-0270 610
46-0350 608
46-0351 608
46-0352 608
46-0353 608
46-0354 608
46-0355 608
46-0356 608
46-0357 608
46-0360 608
46-0361 608
46-0362 608
46-0363 608
46-0364 608
46-0365 608
46-0366 608
46-0370 608
46-0371 608
46-0372 608
46-0373 608
46-0374 608
46-0375 608
46-0376 608
46-0380 610
46-0381 610
46-0382 610
46-0383 610
46-0384 610
46-0710 589
46-0711 589
46-0712 589
46-0713 589
46-0801 612
46-0802 612
46-0803 612
46-0805 612
46-0806 612
46-0807 612
46-0808 612
46-0811 612
46-0812 612
46-0813 612
46-0815 612
46-0816 612
46-0817 612
46-0818 612

Kat. -Nr. Seite
Cat. No. Page
Núm. Ref. Página
No. Réf. Page
No. Cat. Pagina

46-0822 615
46-0823 615
46-0900 611
46-0901 611
46-0902 611
46-0903 611
46-0904 611
46-0905 611
46-0906 611
46-0907 611
46-0908 611
46-0909 611
46-0910 611
46-0911 611
46-0912 611
46-0920 613
46-0921 613
46-0925 613
46-0926 613
46-0930 613
46-0931 613
46-0940 613
46-0941 613
46-0942 613
46-0945 613
46-0946 613
46-0947 613
46-0950 614
46-0952 614
46-0954 614
46-0956 614
46-0958 614
46-0960 615
46-0961 615
46-0962 615
46-0965 615
46-0966 615
46-0967 615
46-0970 616
46-0971 616
46-0972 616
46-0973 616

47
47-0100 618
47-0101 617
47-0102 617
47-0103 617
47-0105 618
47-0108 617
47-0109 617
47-0110 617
47-0111 619
47-0115 618
47-0116 620
47-0117 618

Kat. -Nr. Seite
Cat. No. Page
Núm. Ref. Página
No. Réf. Page
No. Cat. Pagina

47-0118 619
47-0119 619
47-0120 619
47-0121 620
47-0126 621
47-0127 621
47-0129 621
47-0132 617
47-0133 618
47-0134 618
47-0135 618
47-0136 617
47-0140 619
47-0141 619
47-0142 619
47-0143 619
47-0146 620
47-0147 620
47-0148 620
47-0149 620
47-0150 621
47-0191 619
47-0195 618
47-0197 618
47-0200 594
47-0210 594
47-0211 594
47-0217 594
47-0218 595
47-0230 592
47-0231 592
47-0232 592
47-0240 570
47-0241 570
47-0243 570
47-0244 570
47-0245 570
47-0248 570
47-0250 38
47-0251 38
47-0252 38
47-0254 38
47-0255 38
47-0256 38
47-0260 39
47-0262 38
47-0263 38
47-0264 39
47-0265 39
47-0266 39
47-0290 571
47-0291 571
47-0300 572
47-0305 572
47-0310 572
47-0311 572

| Kat. -Nr. | Seite | Kat. -Nr. | Seite | Kat. -Nr. | Seite | Kat. -Nr. | Seite |
|------------------|--------------|------------------|--------------|------------------|--------------|------------------|--------------|
| Cat. No. | Page | Cat. No. | Page | Cat. No. | Page | Cat. No. | Page |
| Núm. Ref. | Página | Núm. Ref. | Página | Núm. Ref. | Página | Núm. Ref. | Página |
| No. Réf. | Page | No. Réf. | Page | No. Réf. | Page | No. Réf. | Page |
| No. Cat. | Pagina | No. Cat. | Pagina | No. Cat. | Pagina | No. Cat. | Pagina |
| 47-0315 | 573 | 47-0482 | 601 | 47-0545 | 602 | 47-1611 | 606 |
| 47-0316 | 573 | 47-0483 | 601 | 47-0546 | 602 | 47-1612 | 606 |
| 47-0317 | 573 | 47-0484 | 601 | 47-0547 | 602 | 47-1613 | 606 |
| 47-0320 | 573 | 47-0485 | 601 | 47-0548 | 602 | 47-1614 | 606 |
| 47-0321 | 573 | 47-0486 | 601 | 47-1520 | 603 | 47-1615 | 606 |
| 47-0322 | 573 | 47-0490 | 602 | 47-1521 | 603 | 47-1616 | 606 |
| 47-0323 | 573 | 47-0491 | 602 | 47-1522 | 603 | 47-1617 | 606 |
| 47-0330 | 573 | 47-0492 | 602 | 47-1523 | 603 | 47-1618 | 606 |
| 47-0331 | 573 | 47-0493 | 602 | 47-1524 | 603 | 47-1619 | 606 |
| 47-0332 | 573 | 47-0494 | 602 | 47-1525 | 603 | | |
| 47-0334 | 573 | 47-0495 | 602 | 47-1526 | 603 | 48 | |
| 47-0335 | 573 | 47-0496 | 602 | 47-1527 | 603 | 48-0070 | 576 |
| 47-0350 | 687 | 47-0499 | 602 | 47-1528 | 603 | 48-0072 | 576 |
| 47-0360 | 687 | 47-0500 | 602 | 47-1540 | 604 | 48-0075 | 576 |
| 47-0365 | 687 | 47-0501 | 602 | 47-1541 | 604 | 48-0087 | 574 |
| 47-0367 | 687 | 47-0502 | 602 | 47-1542 | 604 | 48-0090 | 574 |
| 47-0370 | 687 | 47-0503 | 602 | 47-1543 | 604 | 48-0091 | 574 |
| 47-0371 | 687 | 47-0504 | 602 | 47-1550 | 604 | 48-0105 | 582 |
| 47-0375 | 687 | 47-0505 | 602 | 47-1551 | 604 | 48-0107 | 582 |
| 47-0400 | 600 | 47-0506 | 602 | 47-1552 | 604 | 48-0108 | 582 |
| 47-0405 | 600 | 47-0507 | 602 | 47-1553 | 604 | 48-0110 | 582 |
| 47-0410 | 600 | 47-0508 | 602 | 47-1560 | 604 | 48-0117 | 587 |
| 47-0414 | 600 | 47-0510 | 602 | 47-1561 | 604 | 48-0118 | 575 |
| 47-0415 | 600 | 47-0511 | 602 | 47-1562 | 604 | 48-0119 | 587 |
| 47-0416 | 600 | 47-0512 | 602 | 47-1563 | 604 | 48-0120 | 575 |
| 47-0420 | 600 | 47-0513 | 602 | 47-1570 | 605 | 48-0121 | 575 |
| 47-0421 | 600 | 47-0514 | 602 | 47-1571 | 605 | 48-0122 | 575 |
| 47-0422 | 600 | 47-0515 | 602 | 47-1572 | 605 | 48-0123 | 587 |
| 47-0423 | 600 | 47-0516 | 602 | 47-1573 | 605 | 48-0125 | 587 |
| 47-0425 | 599 | 47-0517 | 602 | 47-1574 | 605 | 48-0126 | 587 |
| 47-0426 | 600 | 47-0518 | 602 | 47-1575 | 605 | 48-0128 | 587 |
| 47-0427 | 600 | 47-0519 | 602 | 47-1576 | 605 | 48-0129 | 587 |
| 47-0428 | 600 | 47-0520 | 603 | 47-1577 | 605 | 48-0131 | 575 |
| 47-0429 | 600 | 47-0521 | 603 | 47-1578 | 605 | 48-0132 | 588 |
| 47-0430 | 601 | 47-0522 | 603 | 47-1579 | 605 | 48-0134 | 588 |
| 47-0431 | 601 | 47-0523 | 603 | 47-1580 | 605 | 48-0138 | 590 |
| 47-0440 | 599 | 47-0524 | 603 | 47-1581 | 605 | 48-0141 | 590 |
| 47-0441 | 599 | 47-0525 | 603 | 47-1582 | 605 | 48-0142 | 588 |
| 47-0442 | 599 | 47-0526 | 603 | 47-1583 | 605 | 48-0143 | 588 |
| 47-0453 | 599 | 47-0527 | 603 | 47-1584 | 605 | 48-0146 | 590 |
| 47-0455 | 599 | 47-0528 | 603 | 47-1585 | 605 | 48-0147 | 590 |
| 47-0456 | 599 | 47-0530 | 603 | 47-1586 | 605 | 48-0148 | 588 |
| 47-0457 | 599 | 47-0531 | 603 | 47-1587 | 605 | 48-0149 | 588 |
| 47-0461 | 601 | 47-0532 | 603 | 47-1588 | 605 | 48-0151 | 590 |
| 47-0462 | 601 | 47-0533 | 603 | 47-1589 | 605 | 48-0152 | 590 |
| 47-0463 | 601 | 47-0534 | 603 | 47-1600 | 606 | 48-0153 | 590 |
| 47-0464 | 601 | 47-0535 | 603 | 47-1601 | 606 | 48-0154 | 590 |
| 47-0465 | 601 | 47-0536 | 603 | 47-1602 | 606 | 48-0156 | 591 |
| 47-0466 | 601 | 47-0537 | 603 | 47-1603 | 606 | 48-0157 | 591 |
| 47-0471 | 601 | 47-0538 | 603 | 47-1604 | 606 | 48-0158 | 591 |
| 47-0472 | 601 | 47-0539 | 602 | 47-1605 | 606 | 48-0159 | 591 |
| 47-0473 | 601 | 47-0540 | 602 | 47-1606 | 606 | 48-0162 | 497 |
| 47-0474 | 601 | 47-0541 | 602 | 47-1607 | 606 | 48-0163 | 497 |
| 47-0475 | 601 | 47-0542 | 602 | 47-1608 | 606 | 48-0164 | 497 |
| 47-0476 | 601 | 47-0543 | 602 | 47-1609 | 606 | 48-0165 | 497 |
| 47-0481 | 601 | 47-0544 | 602 | 47-1610 | 606 | 48-0166 | 497 |

Nummernverzeichnis

Index of Numbers

Índice de números de referencias

Index des numéros de références

Indice dei codici

LAWTON
Medizintechnik

| Kat. -Nr. | Seite | Kat. -Nr. | Seite | Kat. -Nr. | Seite | Kat. -Nr. | Seite |
|------------------|--------------|------------------|--------------|------------------|--------------|------------------|--------------|
| Cat. No. | Page | Cat. No. | Page | Cat. No. | Page | Cat. No. | Page |
| Núm. Ref. | Página | Núm. Ref. | Página | Núm. Ref. | Page | Núm. Ref. | Página |
| No. Réf. | Page | No. Réf. | Page | No. Réf. | Page | No. Réf. | Page |
| No. Cat. | Página | No. Cat. | Página | No. Cat. | Página | No. Cat. | Página |
| 48-0170 | 574 | 48-0406 | 640 | 48-0635 | 658 | 48-1497 | 667 |
| 48-0172 | 583 | 48-0412 | 640 | 48-0636 | 658 | 48-1498 | 667 |
| 48-0174 | 591 | 48-0415 | 640 | 48-0640 | 659 | 48-1499 | 668 |
| 48-0175 | 591 | 48-0416 | 640 | 48-0641 | 659 | 48-1508 | 655 |
| 48-0176 | 591 | 48-0424 | 648 | 48-0644 | 659 | 48-1510 | 655 |
| 48-0177 | 574 | 48-0425 | 648 | 48-0645 | 658 | 48-1512 | 655 |
| 48-0200 | 589 | 48-0426 | 648 | 48-0652 | 654 | 48-1514 | 655 |
| 48-0201 | 589 | 48-0427 | 648 | 48-0654 | 654 | 48-1515 | 655 |
| 48-0202 | 589 | 48-0428 | 648 | 48-0656 | 654 | 48-1516 | 655 |
| 48-0203 | 589 | 48-0429 | 648 | 48-0660 | 658 | 48-1518 | 655 |
| 48-0204 | 589 | 48-0435 | 624 | 48-0661 | 658 | 48-1520 | 655 |
| 48-0205 | 589 | 48-0436 | 624 | 48-0665 | 659 | 48-1522 | 655 |
| 48-0206 | 589 | 48-0460 | 649 | 48-0666 | 659 | 48-1525 | 655 |
| 48-0210 | 584 | 48-0461 | 649 | 48-0667 | 659 | 48-1527 | 655 |
| 48-0212 | 584 | 48-0463 | 649 | 48-0674 | 659 | 48-1708 | 655 |
| 48-0214 | 584 | 48-0464 | 649 | 48-0675 | 659 | 48-1710 | 655 |
| 48-0216 | 584 | 48-0465 | 649 | 48-0676 | 659 | 48-1712 | 655 |
| 48-0218 | 585 | 48-0470 | 666 | 48-0902 | 660 | 48-1714 | 655 |
| 48-0220 | 585 | 48-0471 | 666 | 48-0903 | 660 | 48-1715 | 655 |
| 48-0222 | 585 | 48-0484 | 663 | 48-0904 | 660 | 48-1716 | 655 |
| 48-0224 | 585 | 48-0485 | 663 | 48-0905 | 660 | 48-1718 | 655 |
| 48-0226 | 585 | 48-0486 | 663 | 48-0906 | 660 | 48-1720 | 655 |
| 48-0228 | 585 | 48-0487 | 663 | 48-0907 | 660 | 48-1722 | 655 |
| 48-0307 | 642 | 48-0491 | 664 | 48-0908 | 660 | 48-1725 | 655 |
| 48-0308 | 642 | 48-0492 | 664 | 48-0909 | 660 | 48-1727 | 655 |
| 48-0309 | 642 | 48-0493 | 664 | 48-0910 | 660 | 48-1828 | 655 |
| 48-0310 | 643 | 48-0494 | 664 | 48-0912 | 660 | 48-1830 | 655 |
| 48-0311 | 643 | 48-0495 | 664 | 48-0915 | 660 | 48-1832 | 655 |
| 48-0312 | 643 | 48-0496 | 664 | 48-0920 | 660 | 48-1834 | 655 |
| 48-0317 | 642 | 48-0498 | 668 | 48-0922 | 662 | 48-1835 | 655 |
| 48-0318 | 642 | 48-0499 | 668 | 48-0926 | 660 | 48-1836 | 655 |
| 48-0330 | 643 | 48-0517 | 689 | 48-0927 | 660 | 48-1838 | 655 |
| 48-0331 | 643 | 48-0518 | 689 | 48-0928 | 660 | 48-1840 | 655 |
| 48-0332 | 643 | 48-0580 | 653 | 48-0931 | 661 | 48-1842 | 655 |
| 48-0333 | 643 | 48-0581 | 653 | 48-0932 | 661 | 48-1845 | 655 |
| 48-0339 | 644 | 48-0585 | 653 | 48-0933 | 661 | 48-1847 | 655 |
| 48-0340 | 644 | 48-0586 | 653 | 48-0950 | 669 | 48-1878 | 655 |
| 48-0341 | 644 | 48-0612 | 653 | 48-0951 | 669 | 48-1880 | 655 |
| 48-0351 | 646 | 48-0613 | 653 | 48-0952 | 669 | 48-1882 | 655 |
| 48-0352 | 646 | 48-0615 | 653 | 48-0953 | 669 | 48-1884 | 655 |
| 48-0353 | 646 | 48-0616 | 653 | 48-0955 | 669 | 48-1885 | 655 |
| 48-0354 | 646 | 48-0620 | 654 | 48-0956 | 669 | 48-1886 | 655 |
| 48-0355 | 646 | 48-0621 | 654 | 48-0957 | 669 | 48-1888 | 655 |
| 48-0360 | 646 | 48-0622 | 654 | 48-0958 | 669 | 48-1890 | 655 |
| 48-0363 | 646 | 48-0623 | 654 | 48-1019 | 650 | 48-1892 | 655 |
| 48-0364 | 646 | 48-0624 | 654 | 48-1020 | 650 | 48-1895 | 655 |
| 48-0376 | 646 | 48-0625 | 654 | 48-1023 | 650 | 48-1897 | 655 |
| 48-0377 | 646 | 48-0626 | 654 | 48-1030 | 650 | 48-2038 | 655 |
| 48-0378 | 646 | 48-0627 | 654 | 48-1031 | 650 | 48-2040 | 655 |
| 48-0379 | 646 | 48-0628 | 654 | 48-1035 | 650 | 48-2042 | 655 |
| 48-0380 | 647 | 48-0629 | 654 | 48-1484 | 663 | 48-2044 | 655 |
| 48-0382 | 647 | 48-0630 | 658 | 48-1486 | 663 | 48-2045 | 655 |
| 48-0384 | 647 | 48-0631 | 658 | 48-1488 | 663 | 48-2046 | 655 |
| 48-0388 | 648 | 48-0632 | 658 | 48-1491 | 667 | 48-2048 | 655 |
| 48-0400 | 640 | 48-0633 | 658 | 48-1495 | 667 | 48-2050 | 655 |
| 48-0405 | 640 | 48-0634 | 658 | 48-1496 | 667 | 48-2052 | 655 |

Nummernverzeichnis

Index of Numbers

Índice de números de referencias

Index des numéros de références

Indice dei codici

| Kat. -Nr. | Seite | Kat. -Nr. | Seite | Kat. -Nr. | Seite | Kat. -Nr. | Seite |
|------------------|--------------|------------------|--------------|------------------|--------------|------------------|--------------|
| Cat. No. | Page | Cat. No. | Page | Cat. No. | Page | Cat. No. | Page |
| Núm. Ref. | Página | Núm. Ref. | Página | Núm. Ref. | Página | Núm. Ref. | Página |
| No. Réf. | Page | No. Réf. | Page | No. Réf. | Page | No. Réf. | Page |
| No. Cat. | Pagina | No. Cat. | Pagina | No. Cat. | Pagina | No. Cat. | Pagina |
| 48-2055 | 655 | 50 | | 51-0571 | 693 | 51-0830 | 323 |
| 48-2057 | 655 | 50-0107 | 652 | 51-0572 | 693 | 51-0832 | 323 |
| 48-2058 | 655 | 50-0120 | 651 | 51-0573 | 693 | 51-0833 | 323 |
| 48-2060 | 655 | 50-0121 | 651 | 51-0574 | 693 | 51-0834 | 323 |
| 48-2062 | 655 | 50-0140 | 652 | 51-0575 | 693 | 51-0835 | 323 |
| 48-2064 | 655 | 50-0141 | 652 | 51-0576 | 693 | 51-0866 | 323 |
| 48-2065 | 655 | 50-0142 | 652 | 51-0577 | 692 | 51-0867 | 323 |
| 48-2066 | 655 | 50-0143 | 652 | 51-0578 | 692 | 51-0868 | 323 |
| 48-2068 | 655 | 50-0144 | 652 | 51-0600 | 218 | 51-0870 | 323 |
| 48-2070 | 655 | 50-0145 | 652 | 51-0610 | 217 | 51-0871 | 323 |
| 48-2072 | 655 | 50-0146 | 652 | 51-0612 | 217 | | |
| 48-2075 | 655 | 50-0147 | 652 | 51-0613 | 217 | 52 | |
| 48-2077 | 655 | 50-0150 | 652 | 51-0615 | 216 | 52-0090 | 586 |
| 48-2078 | 655 | 50-0151 | 652 | 51-0617 | 215 | 52-0091 | 586 |
| 48-2080 | 655 | 50-0160 | 652 | 51-0618 | 215 | 52-0092 | 586 |
| 48-2082 | 655 | 50-0190 | 650 | 51-0634 | 700 | 52-0100 | 586 |
| 48-2084 | 655 | 50-0255 | 688 | 51-0636 | 700 | 52-0105 | 586 |
| 48-2085 | 655 | 50-0335 | 687 | 51-0640 | 700 | 52-0110 | 586 |
| 48-2086 | 655 | 50-0400 | 100 | 51-0641 | 700 | 52-0115 | 586 |
| 48-2088 | 655 | 50-0419 | 100 | 51-0643 | 700 | 52-0200 | 701 |
| 48-2090 | 655 | 50-0420 | 100 | 51-0644 | 700 | 52-0202 | 701 |
| 48-2092 | 655 | 50-0465 | 100 | 51-0650 | 221 | 52-0205 | 701 |
| 48-2095 | 655 | 50-0600 | 690 | 51-0657 | 214 | 52-0210 | 701 |
| 48-2097 | 655 | 50-0602 | 690 | 51-0658 | 214 | 52-0212 | 701 |
| 48-2100 | 657 | 50-0620 | 155 | 51-0660 | 214 | 52-0214 | 701 |
| 48-2102 | 657 | 50-0621 | 155 | 51-0661 | 214 | 52-0216 | 701 |
| 48-2104 | 657 | 50-0622 | 155 | 51-0662 | 214 | 52-0220 | 702 |
| 48-2106 | 657 | 50-0623 | 155 | 51-0664 | 214 | 52-0222 | 702 |
| 48-2108 | 657 | 50-0631 | 690 | 51-0665 | 214 | 52-0224 | 703 |
| 48-2158 | 656 | 50-0633 | 690 | 51-0666 | 214 | 52-0226 | 703 |
| 48-2160 | 656 | 50-0635 | 690 | 51-0667 | 214 | 52-0228 | 703 |
| 48-2162 | 656 | 50-0649 | 691 | 51-0668 | 215 | 52-0230 | 703 |
| 48-2164 | 656 | 50-0650 | 691 | 51-0669 | 215 | 52-0232 | 703 |
| 48-2165 | 656 | 50-0652 | 691 | 51-0729 | 698 | 52-0234 | 703 |
| 48-2166 | 656 | 50-0658 | 691 | 51-0730 | 698 | 52-0236 | 704 |
| 48-2168 | 656 | 50-0679 | 690 | 51-0731 | 698 | 52-0238 | 704 |
| 48-2170 | 656 | 50-1001 | 651 | 51-0735 | 698 | 52-0240 | 705 |
| 48-2172 | 656 | 50-1002 | 651 | 51-0745 | 698 | 52-0242 | 705 |
| 48-2175 | 656 | 50-1003 | 651 | 51-0790 | 699 | 52-0244 | 705 |
| 48-2177 | 656 | 50-1004 | 651 | 51-0792 | 699 | 52-0246 | 705 |
| 48-2178 | 656 | 50-1005 | 651 | 51-0794 | 699 | 52-0250 | 701 |
| 48-2180 | 656 | 50-1006 | 651 | 51-0796 | 699 | 52-0252 | 691 |
| 48-2182 | 656 | 50-1007 | 651 | 51-0798 | 699 | 52-0254 | 691 |
| 48-2184 | 656 | 50-1010 | 651 | 51-0800 | 323 | 52-0261 | 706 |
| 48-2185 | 656 | 50-1015 | 651 | 51-0801 | 323 | 52-0262 | 706 |
| 48-2186 | 656 | 50-1016 | 651 | 51-0802 | 323 | 52-0263 | 706 |
| 48-2188 | 656 | 50-1017 | 651 | 51-0803 | 323 | 52-0264 | 706 |
| 48-2190 | 656 | 50-1018 | 651 | 51-0806 | 323 | 52-0265 | 706 |
| 48-2192 | 656 | | | 51-0807 | 323 | 52-0266 | 706 |
| 48-2195 | 656 | 51 | | 51-0808 | 323 | 52-0267 | 706 |
| 48-2197 | 656 | 51-0524 | 692 | 51-0810 | 323 | 52-0290 | 706 |
| | | 51-0528 | 692 | 51-0811 | 323 | 52-0291 | 706 |
| 49 | | 51-0534 | 692 | 51-0812 | 323 | 52-0298 | 706 |
| 49-4260 | 329 | 51-0540 | 692 | 51-0818 | 323 | 52-0300 | 706 |
| 49-4262 | 329 | 51-0541 | 692 | 51-0828 | 323 | 52-0301 | 706 |
| 49-4264 | 329 | 51-0570 | 693 | 51-0829 | 323 | 52-0302 | 706 |

Nummernverzeichnis

Index of Numbers

Índice de números de referencias

Index des numéros de références

Indice dei codici

| Kat. -Nr. | Seite | Kat. -Nr. | Seite | Kat. -Nr. | Seite | Kat. -Nr. | Seite |
|------------------|--------------|------------------|--------------|------------------|--------------|------------------|--------------|
| Cat. No. | Page | Cat. No. | Page | Cat. No. | Page | Cat. No. | Page |
| Núm. Ref. | Página | Núm. Ref. | Página | Núm. Ref. | Page | Núm. Ref. | Página |
| No. Réf. | Page | No. Réf. | Page | No. Réf. | Page | No. Réf. | Page |
| No. Cat. | Página | No. Cat. | Página | No. Cat. | Página | No. Cat. | Página |
| 52-0303 | 706 | 52-0721 | 289 | 52-0784 | 293 | 53-0402 | 716 |
| 52-0304 | 706 | 52-0722 | 289 | 52-0785 | 293 | 53-0403 | 716 |
| 52-0305 | 706 | 52-0723 | 289 | 52-0786 | 293 | 53-0404 | 716 |
| 52-0306 | 706 | 52-0724 | 289 | 52-0790 | 293 | 53-0405 | 716 |
| 52-0307 | 706 | 52-0725 | 289 | 52-0791 | 293 | 53-0406 | 716 |
| 52-0350 | 272 | 52-0726 | 289 | 52-0792 | 293 | 53-0407 | 716 |
| 52-0394 | 276 | 52-0727 | 289 | 52-0793 | 293 | 53-0408 | 716 |
| 52-0395 | 276 | 52-0730 | 289 | 52-0794 | 293 | 53-0430 | 717 |
| 52-0490 | 279 | 52-0731 | 289 | 52-0795 | 293 | 53-0431 | 717 |
| 52-0491 | 279 | 52-0732 | 289 | 52-0796 | 293 | 53-0432 | 717 |
| 52-0494 | 279 | 52-0733 | 289 | 52-0797 | 293 | 53-0435 | 717 |
| 52-0497 | 279 | 52-0734 | 289 | 52-0798 | 293 | 53-0436 | 717 |
| 52-0499 | 280 | 52-0735 | 289 | 52-0799 | 293 | 53-0437 | 717 |
| 52-0512 | 231 | 52-0736 | 289 | 52-0800 | 294 | 53-0450 | 717 |
| 52-0514 | 231 | 52-0737 | 289 | 52-0801 | 294 | 53-0451 | 717 |
| 52-0516 | 296 | 52-0739 | 289 | 52-0802 | 294 | 53-0452 | 717 |
| 52-0517 | 296 | 52-0740 | 290 | 52-0803 | 294 | 53-0510 | 718 |
| 52-0520 | 689 | 52-0742 | 290 | 52-0804 | 294 | 53-0512 | 718 |
| 52-0525 | 689 | 52-0745 | 291 | 52-0805 | 294 | 53-0514 | 718 |
| 52-0540 | 689 | 52-0746 | 291 | 52-0806 | 294 | 53-0516 | 718 |
| 52-0542 | 689 | 52-0750 | 292 | 52-0807 | 294 | 53-0518 | 718 |
| 52-0555 | 286 | 52-0751 | 292 | 52-0810 | 295 | 53-0520 | 718 |
| 52-0583 | 286 | 52-0770 | 292 | 52-0812 | 295 | 53-0522 | 718 |
| 52-0585 | 286 | 52-0770 | 293 | 52-0814 | 295 | 53-0524 | 718 |
| 52-0588 | 286 | 52-0771 | 292 | 52-0816 | 295 | 53-0526 | 718 |
| 52-0590 | 286 | 52-0771 | 293 | 52-0818 | 295 | 53-0528 | 718 |
| 52-0600 | 287 | 52-0772 | 292 | 52-1301 | 296 | 53-0530 | 718 |
| 52-0601 | 287 | 52-0772 | 293 | 52-1305 | 296 | 53-0532 | 718 |
| 52-0610 | 287 | 52-0773 | 292 | 52-1345 | 285 | 53-0534 | 718 |
| 52-0611 | 287 | 52-0773 | 293 | 52-1346 | 285 | 53-0536 | 718 |
| 52-0613 | 287 | 52-0774 | 292 | 52-1355 | 285 | 53-0538 | 718 |
| 52-0620 | 287 | 52-0774 | 293 | 52-1356 | 285 | 53-0542 | 718 |
| 52-0621 | 287 | 52-0775 | 292 | 52-1360 | 285 | 53-0544 | 718 |
| 52-0685 | 287 | 52-0775 | 293 | 52-1361 | 285 | 53-0546 | 718 |
| 52-0686 | 287 | 52-0776 | 292 | 52-1362 | 285 | 53-0552 | 718 |
| 52-0687 | 287 | 52-0776 | 293 | 52-1363 | 285 | 53-0554 | 718 |
| 52-0700 | 288 | 52-0777 | 292 | 52-1364 | 285 | 53-0556 | 718 |
| 52-0701 | 288 | 52-0777 | 293 | 52-1370 | 285 | 53-0562 | 718 |
| 52-0702 | 288 | 52-0778 | 292 | 52-1371 | 285 | 53-0564 | 718 |
| 52-0705 | 288 | 52-0778 | 293 | 52-1372 | 285 | 53-0566 | 718 |
| 52-0705 | 289 | 52-0779 | 292 | 52-1373 | 285 | 53-0572 | 719 |
| 52-0706 | 289 | 52-0779 | 293 | 52-1374 | 285 | 53-0574 | 719 |
| 52-0710 | 289 | 52-0780 | 290 | | | 53-0582 | 719 |
| 52-0711 | 288 | 52-0780 | 291 | 53 | | 53-0584 | 719 |
| 52-0711 | 289 | 52-0780 | 293 | 53-0300 | 719 | 53-0592 | 719 |
| 52-0712 | 288 | 52-0781 | 290 | 53-0370 | 715 | 53-0594 | 719 |
| 52-0712 | 289 | 52-0781 | 291 | 53-0371 | 715 | 53-0970 | 688 |
| 52-0713 | 288 | 52-0781 | 293 | 53-0372 | 715 | 53-0971 | 688 |
| 52-0713 | 289 | 52-0782 | 290 | 53-0373 | 715 | 53-0975 | 688 |
| 52-0714 | 288 | 52-0782 | 291 | 53-0374 | 715 | 53-0976 | 688 |
| 52-0714 | 289 | 52-0782 | 293 | 53-0375 | 715 | 53-0977 | 688 |
| 52-0715 | 288 | 52-0783 | 290 | 53-0376 | 715 | | |
| 52-0715 | 289 | 52-0783 | 291 | 53-0377 | 715 | 57 | |
| 52-0716 | 289 | 52-0783 | 293 | 53-0378 | 715 | 57-0050 | 695 |
| 52-0717 | 289 | 52-0784 | 290 | 53-0400 | 716 | 57-0080 | 694 |
| 52-0720 | 289 | 52-0784 | 291 | 53-0401 | 716 | 57-0085 | 694 |

| Kat. -Nr. | Seite | Kat. -Nr. | Seite | Kat. -Nr. | Seite | Kat. -Nr. | Seite |
|------------------|--------------|------------------|--------------|------------------|--------------|------------------|--------------|
| Cat. No. | Page | Cat. No. | Page | Cat. No. | Page | Cat. No. | Page |
| Núm. Ref. | Página | Núm. Ref. | Página | Núm. Ref. | Página | Núm. Ref. | Página |
| No. Réf. | Page | No. Réf. | Page | No. Réf. | Page | No. Réf. | Page |
| No. Cat. | Pagina | No. Cat. | Pagina | No. Cat. | Pagina | No. Cat. | Pagina |
| 57-0090 | 694 | 57-1081 | 67 | 60-1220 | 218 | 62-3763 | 360 |
| 57-0091 | 695 | 57-1082 | 67 | 60-1221 | 218 | 62-3764 | 360 |
| 57-0092 | 695 | 57-1083 | 67 | 60-1260 | 217 | 62-3765 | 360 |
| 57-0093 | 695 | 57-1086 | 67 | 60-1780 | 36 | 62-3768 | 360 |
| 57-0094 | 695 | 57-1087 | 67 | 60-1791 | 36 | 62-3769 | 360 |
| 57-0095 | 694 | 57-1088 | 67 | 60-1793 | 36 | 62-3778 | 360 |
| 57-0096 | 695 | 57-1089 | 67 | 60-1797 | 36 | 62-3779 | 360 |
| 57-0098 | 695 | 57-1095 | 362 | 62 | | 63 | |
| 57-0099 | 695 | 57-1096 | 362 | 62-0250 | 139 | 63-0010 | 70 |
| 57-0100 | 694 | 57-1097 | 362 | 62-0251 | 128 | 63-0011 | 70 |
| 57-0105 | 694 | 57-1098 | 362 | 62-0252 | 139 | 63-0050 | 70 |
| 57-0110 | 694 | 57-1099 | 362 | 62-0253 | 128 | 63-0051 | 70 |
| 57-0115 | 694 | 57-1110 | 125 | 62-0254 | 138 | 63-0099 | 92 |
| 57-0120 | 695 | 57-1112 | 125 | 62-0255 | 138 | 63-0100 | 92 |
| 57-0125 | 695 | 57-1114 | 125 | 62-0256 | 138 | 63-0150 | 92 |
| 57-0130 | 695 | 57-1116 | 125 | 62-0261 | 128 | 63-0151 | 92 |
| 57-0132 | 696 | 57-1120 | 125 | 62-0263 | 128 | 63-0200 | 88 |
| 57-0134 | 696 | 57-1122 | 125 | 62-0271 | 128 | 63-0201 | 88 |
| 57-0136 | 696 | 57-1124 | 125 | 62-0273 | 128 | 63-0202 | 88 |
| 57-0138 | 696 | 57-1126 | 125 | 62-0280 | 139 | 63-0330 | 68 |
| 57-0142 | 696 | 57-1130 | 125 | 62-0281 | 139 | 63-0331 | 68 |
| 57-0144 | 696 | 57-1140 | 126 | 62-0283 | 139 | 63-0332 | 68 |
| 57-0146 | 696 | 57-1142 | 126 | 62-0284 | 139 | 63-0333 | 68 |
| 57-0148 | 696 | 57-1144 | 126 | 62-0561 | 138 | 63-0402 | 88 |
| 57-0150 | 697 | 57-1146 | 126 | 62-0749 | 138 | 63-0403 | 88 |
| 57-0152 | 697 | 57-1148 | 126 | 62-0750 | 138 | 63-0420 | 92 |
| 57-0154 | 697 | 57-1160 | 126 | 62-0751 | 138 | 63-0421 | 92 |
| 57-0175 | 694 | 57-1162 | 126 | 62-0770 | 138 | 63-0906 | 68 |
| 57-0325 | 118 | 57-1164 | 127 | 62-0771 | 138 | 63-0907 | 68 |
| 57-0365 | 118 | 57-1166 | 127 | 62-0772 | 138 | 63-0910 | 68 |
| 57-0670 | 215 | 57-1171 | 127 | 62-0772 | 138 | 63-0911 | 68 |
| 57-0671 | 215 | 57-1173 | 127 | 62-0848 | 122 | 63-1360 | 94 |
| 57-0672 | 215 | 57-1175 | 127 | 62-0849 | 122 | 63-1400 | 62 |
| 57-0673 | 215 | 57-1181 | 127 | 62-0853 | 122 | 63-1401 | 62 |
| 57-0800 | 697 | 57-1183 | 127 | 62-0862 | 139 | 63-1402 | 62 |
| 57-0805 | 697 | 57-1185 | 127 | 62-0864 | 139 | 63-1403 | 62 |
| 57-0810 | 697 | 57-1250 | 719 | 62-1220 | 152 | 63-1406 | 62 |
| 57-0815 | 697 | 57-1272 | 737 | 62-1400 | 152 | 63-1407 | 62 |
| 57-0850 | 215 | 57-1276 | 737 | 62-1402 | 152 | 63-1408 | 62 |
| 57-0851 | 215 | 57-1286 | 720 | 62-1405 | 152 | 63-1800 | 7 |
| 57-0855 | 215 | 57-1294 | 729 | 62-1420 | 152 | 63-1801 | 7 |
| 57-0856 | 215 | 57-1296 | 730 | 62-1460 | 152 | 63-2200 | 312 |
| 57-0860 | 212 | 57-1298 | 730 | 62-3736 | 358 | 63-2201 | 312 |
| 57-0861 | 212 | | | 62-3739 | 358 | 63-2202 | 312 |
| 57-0866 | 212 | 60 | | 62-3740 | 358 | 63-2203 | 312 |
| 57-1054 | 66 | 60-1110 | 213 | 62-3741 | 358 | 63-2204 | 312 |
| 57-1055 | 66 | 60-1111 | 213 | 62-3742 | 358 | 63-2205 | 312 |
| 57-1064 | 66 | 60-1112 | 213 | 62-3743 | 358 | 63-2220 | 312 |
| 57-1065 | 66 | 60-1199 | 222 | 62-3744 | 358 | 63-2221 | 312 |
| 57-1066 | 66 | 60-1200 | 222 | 62-3745 | 358 | 63-2222 | 312 |
| 57-1067 | 66 | 60-1201 | 222 | 62-3750 | 363 | 63-2223 | 312 |
| 57-1069 | 66 | 60-1202 | 222 | 62-3755 | 360 | 63-2224 | 312 |
| 57-1072 | 66 | 60-1203 | 222 | 62-3756 | 360 | 63-2225 | 312 |
| 57-1073 | 66 | 60-1208 | 222 | 62-3760 | 360 | 63-2230 | 312 |
| 57-1074 | 66 | 60-1215 | 216 | 62-3761 | 360 | 63-2231 | 312 |
| 57-1079 | 66 | 60-1216 | 216 | 62-3762 | 360 | | |

Nummernverzeichnis

Index of Numbers

Índice de números de referencias

Index des numéros de références

Indice dei codici

LAWTON
Medizintechnik

| Kat. -Nr. | Seite | Kat. -Nr. | Seite | Kat. -Nr. | Seite | Kat. -Nr. | Seite |
|------------------|--------------|------------------|--------------|------------------|--------------|------------------|--------------|
| Cat. No. | Page | Cat. No. | Page | Cat. No. | Page | Cat. No. | Page |
| Núm. Ref. | Página | Núm. Ref. | Página | Núm. Ref. | Page | Núm. Ref. | Página |
| No. Réf. | Page | No. Réf. | Page | No. Réf. | Page | No. Réf. | Page |
| No. Cat. | Página | No. Cat. | Página | No. Cat. | Página | No. Cat. | Página |
| 63-2233 | 312 | 66-0159 | 598 | 67-0393 | 609 | 70-0671 | 322 |
| 63-2235 | 312 | 66-0160 | 598 | 67-0394 | 609 | 70-0673 | 322 |
| 63-2237 | 312 | 66-0161 | 598 | 67-0395 | 609 | 70-0725 | 321 |
| 63-2239 | 312 | 66-0162 | 599 | 67-0654 | 631 | 70-0787 | 319 |
| 63-2240 | 312 | 66-0163 | 598 | 67-0656 | 631 | 70-0788 | 319 |
| 63-2241 | 312 | 66-0165 | 598 | 67-0702 | 632 | 70-0789 | 319 |
| 63-2243 | 312 | 66-0166 | 598 | 67-0704 | 632 | 70-0794 | 319 |
| 63-2245 | 312 | 66-0167 | 599 | 67-0710 | 632 | 70-0795 | 319 |
| 63-2247 | 312 | 66-0168 | 598 | 67-0711 | 632 | 70-0796 | 319 |
| 63-2249 | 312 | 66-0170 | 598 | 67-0712 | 632 | 70-0804 | 319 |
| 63-2710 | 707 | 66-0171 | 598 | 67-0715 | 631 | 70-0805 | 319 |
| 63-2711 | 707 | 66-0172 | 598 | 67-0716 | 631 | 70-0806 | 319 |
| 63-2720 | 707 | 66-0255 | 213 | 67-0717 | 632 | 70-0810 | 320 |
| 63-2900 | 607 | 66-0256 | 213 | 67-0718 | 632 | 70-0840 | 320 |
| 63-2901 | 607 | 66-0257 | 213 | | | 70-0850 | 319 |
| 63-2905 | 607 | 66-0260 | 213 | 68 | | 70-0860 | 319 |
| 63-2906 | 607 | 66-0261 | 213 | 68-0310 | 604 | 70-0865 | 319 |
| 63-2920 | 583 | 66-0262 | 213 | 68-0311 | 604 | 70-0870 | 320 |
| 63-2925 | 583 | 66-0263 | 213 | 68-0312 | 604 | 70-0871 | 320 |
| 63-2965 | 225 | 66-0264 | 213 | 68-0313 | 604 | 70-0960 | 593 |
| | | 66-0264 | 213 | 68-0314 | 604 | 70-0963 | 593 |
| | | 66-0270 | 213 | 68-0315 | 604 | 70-0965 | 593 |
| | | 66-0271 | 213 | 68-1015 | 212 | 70-0967 | 593 |
| 65 | | 66-0307 | 316 | 68-1017 | 212 | | |
| 65-0230 | 4 | 66-0308 | 316 | 68-1020 | 212 | 71 | |
| 65-0234 | 4 | 66-0309 | 316 | 68-1021 | 212 | 71-0100 | 101 |
| 65-0273 | 4 | 66-0310 | 316 | 68-1022 | 212 | 71-0102 | 101 |
| 65-0274 | 4 | 66-0311 | 316 | 68-1023 | 212 | 71-0120 | 101 |
| 65-0281 | 4 | 66-0312 | 316 | 68-1024 | 212 | 71-0122 | 101 |
| 65-0282 | 4 | 66-0313 | 316 | 68-1025 | 212 | 71-0415 | 583 |
| 65-0285 | 4 | 66-0318 | 316 | 68-1026 | 212 | 71-0416 | 583 |
| 65-0301 | 322 | 66-0319 | 316 | 68-1027 | 212 | 71-0440 | 583 |
| 65-0302 | 322 | 66-0320 | 316 | 68-1028 | 212 | 71-0441 | 583 |
| 65-0303 | 322 | 66-0321 | 316 | 68-1210 | 584 | 71-0450 | 582 |
| 65-0361 | 332 | 66-0322 | 316 | 68-1212 | 584 | 71-0490 | 582 |
| 65-0362 | 332 | 66-0325 | 316 | 68-1214 | 584 | 71-0493 | 582 |
| 65-0363 | 332 | 66-0326 | 316 | 68-1215 | 584 | 71-0516 | 583 |
| 65-0366 | 332 | 66-0327 | 316 | 68-1410 | 322 | 71-0560 | 604 |
| 65-0366 | 333 | 66-0330 | 316 | 68-1440 | 321 | 71-0561 | 604 |
| 65-0368 | 332 | 66-0331 | 316 | 68-1441 | 321 | 71-0562 | 604 |
| 65-0368 | 333 | 66-0332 | 316 | 68-1470 | 321 | 71-0580 | 604 |
| 65-0369 | 332 | 66-0700 | 272 | 68-1471 | 321 | 71-0655 | 607 |
| 65-0370 | 332 | 66-0701 | 272 | 68-1472 | 321 | 71-0656 | 607 |
| 65-0371 | 332 | | | 68-1473 | 321 | | |
| 65-0372 | 332 | 67 | | 68-1474 | 321 | 72 | |
| 65-0379 | 332 | 67-0371 | 609 | 68-1480 | 320 | 72-0202 | 714 |
| 65-0380 | 332 | 67-0372 | 609 | 68-1481 | 320 | 72-0204 | 714 |
| 65-0382 | 332 | 67-0373 | 609 | 68-1482 | 320 | 72-0212 | 714 |
| 65-0384 | 332 | 67-0374 | 609 | 68-1484 | 320 | 72-0214 | 714 |
| 65-0386 | 332 | 67-0375 | 609 | 68-1485 | 320 | 72-0222 | 714 |
| 65-0387 | 332 | 67-0381 | 609 | 68-1486 | 320 | 72-0224 | 714 |
| 65-0388 | 332 | 67-0382 | 609 | 68-1488 | 320 | 72-0242 | 714 |
| 65-0389 | 332 | 67-0383 | 609 | 68-1489 | 320 | 72-0244 | 714 |
| 65-0431 | 317 | 67-0384 | 609 | | | 72-0700 | 708 |
| 65-0432 | 317 | 67-0385 | 609 | 70 | | 72-0701 | 708 |
| | | 67-0391 | 609 | 70-0670 | 322 | 72-0702 | 708 |
| 66 | | 67-0392 | 609 | | | | |
| 66-0158 | 598 | | | | | | |

Kat. -Nr. Seite
Cat. No. Page
Núm. Ref. Página
No. Réf. Page
No. Cat. Pagina

72-0703 708
72-0710 708

75

75-0100 37
75-0215 216
75-0218 216
75-0220 216
75-0221 216
75-0222 216
75-0325 218
75-0330 217
75-0340 219
75-0342 219
75-0344 219
75-0345 219
75-0400 218
75-0412 221
75-0430 221
75-0435 221
75-0620 226

76

76-0415 68
76-0416 68
76-0426 93
76-0427 93
76-0472 82
76-0473 82
76-0475 82
76-0478 82
76-0479 82
76-0540 83
76-0541 83
76-0542 83
76-0543 83
76-0561 94
76-0570 93
76-0571 93
76-0610 82
76-0611 82
76-0620 81
76-0623 81
76-0630 102
76-0631 102
76-0640 102
76-0650 102
76-0760 81

77

77-0350 595
77-0355 595
77-0400 592
77-0410 593
77-0420 593
77-0421 593

Kat. -Nr. Seite
Cat. No. Page
Núm. Ref. Página
No. Réf. Page
No. Cat. Pagina

77-0430 592
77-0431 592
77-0440 593
77-0450 592
77-0607 330
77-0608 330
77-0610 330
77-0620 608
77-0630 608
77-0631 608
77-0632 608
77-0633 608
77-0634 608
77-0650 330
77-0651 330
77-0652 330
77-0653 330
77-0654 330
77-0655 330
77-0670 330
77-0671 330
77-0672 330
77-0673 330
77-0674 330
77-0675 330
77-0680 331
77-0682 331
77-0684 331
77-0685 328
77-0686 328
77-0687 328
77-0688 328
77-0690 331
77-0691 331
77-0692 331
77-0693 331
77-0698 331
77-0699 331
77-0760 582
77-0765 584
77-0766 584
77-0877 333
77-0878 333
77-0883 333
77-0884 333
77-1330 596
77-1332 596
77-1340 596
77-1341 596
77-1342 596
77-1343 596
77-1344 596
77-1345 596
77-1346 596
77-1347 596
77-1348 596

Kat. -Nr. Seite
Cat. No. Page
Núm. Ref. Página
No. Réf. Page
No. Cat. Pagina

77-1349 596
77-1350 597
77-1351 597
77-1352 597
77-1353 597
77-1354 597
77-1607 330
77-1608 330
77-1610 330
77-1650 330
77-1651 330
77-1652 330
77-1653 330
77-1654 330
77-1655 330
77-1670 330
77-1671 330
77-1672 330
77-1673 330
77-1674 330
77-1675 330
77-1680 331
77-1682 331
77-1684 331
77-1690 331
77-1691 331
77-1692 331
77-1693 331

78

78-0120 637
78-0320 366

80

80-0100 22
80-0105 22
80-0112 22
80-0275 22
80-0370 12
80-0372 12
80-0373 12
80-0376 12
80-0377 12
80-0378 12
80-0379 12
80-0735 193
80-0750 179
80-0752 179

81

81-0125 574
81-0308 374
81-0309 374
81-0650 103
81-0655 103
81-0677 103

Kat. -Nr. Seite
Cat. No. Page
Núm. Ref. Página
No. Réf. Page
No. Cat. Pagina

85

85-0001 27
85-0002 27
85-0003 27
85-0004 27
85-0005 27
85-0006 26
85-0007 26
85-0008 27
85-0008 31
85-0009 31
85-0040 29
85-0041 29
85-0042 29
85-0043 29
85-0044 29
85-0045 28
85-0046 28
85-0047 28
85-0047 30
85-0048 28
85-0048 30
85-0058 25
85-0058 29
85-0059 25
85-0059 29
85-0072 24
85-0072 26
85-0073 25
85-0074 25
85-0075 25
85-0076 25
85-0081 31
85-0082 31
85-0083 31
85-0084 31
85-0085 31
85-0087 30
85-0088 30
85-0090 24
85-0091 24
85-0092 25
85-0094 25
85-0094 29
85-0098 25
85-0098 29
85-0099 24
85-0099 26
85-0100 14
85-0101 14
85-0102 14
85-0103 14
85-0104 14
85-0105 14
85-0106 14
85-0107 14

Nummernverzeichnis

Index of Numbers

Indice de números de referencias

Index des numéros de références

Indice dei codici

LAWTON
Medizintechnik

| Kat. -Nr. | Seite | Kat. -Nr. | Seite | Kat. -Nr. | Seite | Kat. -Nr. | Seite |
|------------------|--------------|------------------|--------------|------------------|--------------|------------------|--------------|
| Cat. No. | Page | Cat. No. | Page | Cat. No. | Page | Cat. No. | Page |
| Núm. Ref. | Página | Núm. Ref. | Página | Núm. Ref. | Página | Núm. Ref. | Página |
| No. Réf. | Page | No. Réf. | Page | No. Réf. | Page | No. Réf. | Page |
| No. Cat. | Pagina | No. Cat. | Pagina | No. Cat. | Pagina | No. Cat. | Pagina |
| 85-0108 | 14 | 87-0415 | 725 | 87-0555 | 726 | 90-0622 | 412 |
| 85-0109 | 14 | 87-0416 | 725 | 87-0556 | 726 | 90-0623 | 412 |
| 85-0110 | 14 | 87-0417 | 725 | 87-0557 | 726 | 90-0632 | 412 |
| 85-0111 | 14 | 87-0418 | 725 | 87-0558 | 726 | 90-0633 | 412 |
| 85-0120 | 14 | 87-0419 | 725 | 87-0559 | 726 | 90-0652 | 412 |
| 85-0121 | 14 | 87-0420 | 726 | 87-0564 | 727 | 90-0654 | 412 |
| 85-0122 | 14 | 87-0421 | 726 | 87-0565 | 727 | 90-0656 | 412 |
| 85-0123 | 14 | 87-0422 | 726 | 87-0566 | 727 | 90-0706 | 412 |
| 85-0124 | 14 | 87-0423 | 726 | 87-0567 | 727 | 90-0712 | 412 |
| 85-0125 | 14 | 87-0424 | 726 | 87-0568 | 727 | 90-0713 | 412 |
| 85-0126 | 14 | 87-0425 | 726 | 87-0569 | 727 | 90-0955 | 409 |
| 85-0127 | 14 | 87-0426 | 726 | 87-0574 | 727 | 90-0962 | 410 |
| 85-0128 | 14 | 87-0427 | 726 | 87-0575 | 727 | 90-0969 | 410 |
| 85-0129 | 14 | 87-0428 | 726 | 87-0576 | 727 | 90-0970 | 410 |
| 85-0130 | 14 | 87-0429 | 726 | 87-0577 | 727 | 90-0971 | 410 |
| 85-0131 | 14 | 87-0430 | 726 | 87-0578 | 727 | 90-0972 | 410 |
| 85-0149 | 14 | 87-0431 | 726 | 87-0579 | 727 | 90-0974 | 411 |
| 85-0150 | 14 | 87-0432 | 726 | 87-0584 | 727 | 90-0975 | 411 |
| 85-0151 | 14 | 87-0433 | 726 | 87-0585 | 727 | 90-0976 | 411 |
| 85-0152 | 14 | 87-0434 | 726 | 87-0586 | 727 | 90-0977 | 411 |
| 85-1100 | 13 | 87-0435 | 726 | 87-0587 | 727 | 90-0978 | 411 |
| 85-1101 | 13 | 87-0436 | 726 | 87-0588 | 727 | 90-0979 | 411 |
| 85-1102 | 13 | 87-0437 | 726 | 87-0589 | 727 | | |
| 85-1103 | 13 | 87-0438 | 726 | 87-0650 | 727 | 92 | |
| 85-1104 | 13 | 87-0439 | 726 | 87-1035 | 729 | 92-0101 | 310 |
| 85-1105 | 13 | 87-0440 | 725 | 87-1040 | 730 | 92-0102 | 310 |
| 85-1106 | 13 | 87-0441 | 725 | | | 92-0103 | 310 |
| 85-1107 | 13 | 87-0442 | 725 | 90 | | 92-0104 | 310 |
| 85-1108 | 13 | 87-0443 | 725 | 90-0099 | 407 | 92-0105 | 310 |
| 85-1109 | 13 | 87-0444 | 725 | 90-0100 | 408 | 92-0106 | 310 |
| 85-1110 | 13 | 87-0445 | 725 | 90-0110 | 408 | 92-0108 | 310 |
| 85-1111 | 13 | 87-0446 | 725 | 90-0115 | 408 | 92-0114 | 310 |
| 85-1130 | 13 | 87-0447 | 725 | 90-0116 | 408 | 92-0130 | 310 |
| 85-1132 | 13 | 87-0448 | 725 | 90-0117 | 408 | 92-0136 | 310 |
| | | 87-0449 | 725 | 90-0118 | 408 | 92-0137 | 310 |
| 87 | | 87-0450 | 725 | 90-0119 | 408 | 92-0138 | 310 |
| 87-0135 | 217 | 87-0451 | 725 | 90-0130 | 405 | 92-0139 | 310 |
| 87-0140 | 217 | 87-0452 | 725 | 90-0138 | 405 | 92-0145 | 268 |
| 87-0145 | 728 | 87-0453 | 725 | 90-0140 | 405 | 92-0150 | 268 |
| 87-0146 | 728 | 87-0454 | 725 | 90-0145 | 405 | 92-0200 | 422 |
| 87-0150 | 728 | 87-0455 | 725 | 90-0147 | 406 | 92-0205 | 422 |
| 87-0151 | 728 | 87-0456 | 725 | 90-0148 | 406 | 92-0210 | 422 |
| 87-0200 | 226 | 87-0457 | 725 | 90-0149 | 406 | 92-0215 | 422 |
| 87-0270 | 728 | 87-0458 | 725 | 90-0150 | 407 | 92-0251 | 423 |
| 87-0275 | 728 | 87-0459 | 725 | 90-0151 | 407 | 92-0252 | 423 |
| 87-0400 | 726 | 87-0460 | 725 | 90-0155 | 406 | 92-0255 | 423 |
| 87-0401 | 726 | 87-0461 | 725 | 90-0180 | 407 | 92-0256 | 423 |
| 87-0402 | 726 | 87-0462 | 725 | 90-0205 | 406 | 92-0338 | 372 |
| 87-0403 | 726 | 87-0463 | 725 | 90-0210 | 406 | 92-0340 | 372 |
| 87-0404 | 726 | 87-0464 | 725 | 90-0225 | 407 | 92-0341 | 372 |
| 87-0405 | 726 | 87-0465 | 725 | 90-0230 | 407 | 92-0342 | 372 |
| 87-0406 | 726 | 87-0466 | 725 | 90-0276 | 405 | 92-0343 | 372 |
| 87-0407 | 726 | 87-0467 | 725 | 90-0309 | 409 | 92-0370 | 426 |
| 87-0408 | 726 | 87-0468 | 725 | 90-0311 | 409 | 92-0372 | 426 |
| 87-0409 | 726 | 87-0469 | 725 | 90-0312 | 409 | 92-0480 | 425 |
| 87-0414 | 725 | 87-0554 | 726 | 90-0351 | 409 | 92-0481 | 425 |

| Kat. -Nr. | Seite | Kat. -Nr. | Seite | Kat. -Nr. | Seite | Kat. -Nr. | Seite |
|------------------|--------------|------------------|--------------|------------------|--------------|------------------|--------------|
| Cat. No. | Page | Cat. No. | Page | Cat. No. | Page | Cat. No. | Page |
| Núm. Ref. | Página | Núm. Ref. | Página | Núm. Ref. | Página | Núm. Ref. | Página |
| No. Réf. | Page | No. Réf. | Page | No. Réf. | Page | No. Réf. | Page |
| No. Cat. | Pagina | No. Cat. | Pagina | No. Cat. | Pagina | No. Cat. | Pagina |
| 92-0486 | 425 | 95 | | 95-0202 | 441 | 95-0337 | 444 |
| 92-0501 | 420 | 95-0010 | 430 | 95-0215 | 439 | 95-0338 | 444 |
| 92-0502 | 420 | 95-0015 | 431 | 95-0216 | 439 | 95-0339 | 444 |
| 92-0503 | 420 | 95-0016 | 431 | 95-0217 | 439 | 95-0340 | 444 |
| 92-0504 | 420 | 95-0017 | 431 | 95-0222 | 440 | 95-0341 | 444 |
| 92-0505 | 421 | 95-0020 | 431 | 95-0223 | 254 | 95-0342 | 444 |
| 92-0506 | 421 | 95-0021 | 431 | 95-0224 | 254 | 95-0343 | 444 |
| 92-0544 | 425 | 95-0022 | 431 | 95-0225 | 440 | 95-0344 | 444 |
| 92-0546 | 425 | 95-0030 | 430 | 95-0226 | 440 | 95-0345 | 444 |
| 92-0547 | 426 | 95-0037 | 430 | 95-0227 | 440 | 95-0346 | 444 |
| 92-0548 | 426 | 95-0038 | 430 | 95-0228 | 440 | 95-0360 | 445 |
| 92-0549 | 426 | 95-0039 | 430 | 95-0229 | 440 | 95-0362 | 445 |
| 92-0550 | 190 | 95-0040 | 433 | 95-0231 | 254 | 95-0364 | 445 |
| 92-0560 | 191 | 95-0041 | 433 | 95-0232 | 254 | 95-0365 | 445 |
| 92-0561 | 190 | 95-0042 | 433 | 95-0244 | 440 | 95-0366 | 445 |
| 92-0562 | 190 | 95-0045 | 433 | 95-0245 | 440 | 95-0367 | 445 |
| 92-0580 | 191 | 95-0046 | 433 | 95-0257 | 438 | 95-0368 | 445 |
| 92-0590 | 195 | 95-0047 | 433 | 95-0258 | 438 | 95-0369 | 445 |
| 92-0612 | 192 | 95-0050 | 433 | 95-0259 | 438 | 95-0379 | 444 |
| 92-0613 | 192 | 95-0051 | 433 | 95-0271 | 438 | 95-0380 | 445 |
| 92-0615 | 192 | 95-0052 | 433 | 95-0272 | 438 | 95-0381 | 444 |
| 92-0620 | 193 | 95-0055 | 433 | 95-0273 | 438 | 95-0382 | 444 |
| 92-0624 | 193 | 95-0056 | 433 | 95-0275 | 438 | 95-0383 | 444 |
| 92-0625 | 192 | 95-0057 | 433 | 95-0276 | 438 | 95-0384 | 444 |
| 92-0676 | 193 | 95-0080 | 431 | 95-0277 | 438 | 95-0385 | 444 |
| 92-0677 | 193 | 95-0081 | 431 | 95-0278 | 438 | 95-0386 | 444 |
| 92-1408 | 424 | 95-0082 | 431 | 95-0285 | 440 | 95-0387 | 444 |
| 92-1410 | 424 | 95-0085 | 431 | 95-0286 | 440 | 95-0388 | 444 |
| 92-1412 | 424 | 95-0086 | 431 | 95-0290 | 434 | 95-0389 | 445 |
| 92-1414 | 424 | 95-0087 | 431 | 95-0291 | 434 | 95-0390 | 446 |
| 92-1416 | 424 | 95-0100 | 432 | 95-0292 | 434 | 95-0391 | 444 |
| 92-1418 | 424 | 95-0105 | 432 | 95-0293 | 434 | 95-0392 | 446 |
| 92-1420 | 424 | 95-0110 | 432 | 95-0294 | 434 | 95-0396 | 444 |
| 92-1422 | 424 | 95-0119 | 432 | 95-0295 | 434 | 95-0397 | 444 |
| 92-1424 | 424 | 95-0120 | 432 | 95-0296 | 434 | 95-0399 | 444 |
| 92-1426 | 424 | 95-0121 | 432 | 95-0297 | 434 | 95-0401 | 446 |
| 92-1428 | 424 | 95-0125 | 432 | 95-0298 | 434 | 95-0405 | 446 |
| 92-1430 | 424 | 95-0130 | 432 | 95-0299 | 442 | 95-0406 | 446 |
| 92-1432 | 424 | 95-0135 | 432 | 95-0300 | 447 | 95-0408 | 447 |
| 92-1434 | 424 | 95-0145 | 432 | 95-0301 | 447 | 95-0410 | 447 |
| 92-1436 | 424 | 95-0146 | 433 | 95-0321 | 444 | 95-0414 | 447 |
| 92-1730 | 424 | 95-0147 | 433 | 95-0322 | 444 | 95-0480 | 443 |
| 92-1732 | 424 | 95-0149 | 433 | 95-0323 | 444 | 95-0482 | 443 |
| 92-1734 | 424 | 95-0156 | 432 | 95-0324 | 444 | 95-0483 | 443 |
| 92-1736 | 424 | 95-0175 | 440 | 95-0325 | 444 | 95-0484 | 443 |
| 92-1738 | 424 | 95-0176 | 440 | 95-0326 | 444 | 95-0485 | 443 |
| 92-1740 | 424 | 95-0177 | 440 | 95-0327 | 444 | 95-0486 | 448 |
| 92-1742 | 424 | 95-0178 | 440 | 95-0328 | 444 | 95-0487 | 448 |
| 92-1752 | 424 | 95-0179 | 440 | 95-0329 | 444 | 95-0488 | 448 |
| 92-1754 | 424 | 95-0180 | 440 | 95-0330 | 444 | 95-0550 | 460 |
| 92-1756 | 424 | 95-0182 | 441 | 95-0331 | 444 | 95-0600 | 462 |
| 92-1758 | 424 | 95-0197 | 430 | 95-0332 | 444 | 95-0601 | 462 |
| 92-1760 | 424 | 95-0198 | 430 | 95-0333 | 444 | 95-0604 | 463 |
| 92-1762 | 424 | 95-0199 | 430 | 95-0334 | 444 | 95-0606 | 463 |
| 92-1764 | 424 | 95-0200 | 441 | 95-0335 | 444 | 95-0608 | 463 |
| | | 95-0201 | 441 | 95-0336 | 444 | 95-0610 | 464 |

Nummernverzeichnis

Index of Numbers

Indice de números de referencias

Index des numéros de références

Indice dei codici

LAWTON
Medizintechnik

Kat. -Nr. Seite
Cat. No. Page
Núm. Ref. Página
No. Réf. Page
No. Cat. Pagina

95-0612 464
95-0614 464
95-0616 464
95-0650 461
95-0652 461
95-0659 462
95-0660 462
95-0661 462
95-0662 462
95-0670 461
95-0680 465
95-0681 465
95-0682 465
95-0683 465
95-0684 465
95-0685 465
95-0686 465
95-0687 465
95-0688 465
95-0689 465
95-0690 465
95-0691 465
95-0692 465
95-0693 465
95-0699 465
95-0740 448
95-0741 448
95-0745 449
95-0746 449
95-0747 449
95-0748 449
95-0749 449
95-0750 450
95-0751 450
95-0752 450
95-0753 450
95-0755 451
95-0756 451
95-0757 451
95-0758 451
95-0762 463
95-0764 459
95-0765 459
95-0809 459
95-0810 459
95-0812 459
95-0820 466
95-0821 466
95-0822 466
95-0823 466
95-0824 466
95-0844 605
95-0845 605
95-0846 605
95-0847 605
95-0848 605

Kat. -Nr. Seite
Cat. No. Page
Núm. Ref. Página
No. Réf. Page
No. Cat. Pagina

95-0849 605
95-0850 466
95-0851 466
95-0852 466
95-0853 466
95-0854 466
95-0855 466
95-0860 466
95-0861 466
95-0862 466
95-0863 466
95-0864 466
95-0865 466
95-0927 466
95-0928 468
95-0928 469
95-0929 468
95-0929 469
95-0930 468
95-0930 469
95-0931 468
95-0931 469
95-0932 468
95-0932 469
95-0933 468
95-0933 469
95-0934 468
95-0934 469
95-0935 468
95-0935 469
95-0936 468
95-0936 469
95-0937 468
95-0937 469
95-0938 468
95-0938 469
95-0939 468
95-0939 469
95-0978 468
95-0978 469
95-0988 468
95-0988 469
95-0989 468
95-0989 469
95-0990 468
95-0990 469
95-0991 468
95-0991 469
95-0992 468
95-0992 469
95-0993 468
95-0993 469
95-0994 468
95-0994 469
95-0995 468
95-0995 469

Kat. -Nr. Seite
Cat. No. Page
Núm. Ref. Página
No. Réf. Page
No. Cat. Pagina

95-0996 468
95-0996 469
95-0997 468
95-0997 469
95-0998 468
95-0998 469
95-0999 468
95-0999 469
95-1000 468
95-1000 469
95-1001 468
95-1001 469
95-1002 468
95-1002 469
95-1003 468
95-1003 469
95-1004 468
95-1004 469
95-1005 468
95-1005 469
95-1006 468
95-1006 469
95-1007 468
95-1007 469
95-1008 468
95-1008 469
95-1009 468
95-1009 469
95-1010 468
95-1010 469
95-1018 468
95-1018 469
95-1020 468
95-1020 469
95-1021 468
95-1021 469
95-1022 468
95-1022 469
95-1023 468
95-1023 469
95-1024 468
95-1024 469
95-1025 468
95-1025 469
95-1026 468
95-1026 469
95-1027 468
95-1027 469
95-1028 468
95-1028 469
95-1029 468
95-1029 469
95-1030 468
95-1030 469
95-1061 467
95-1062 467

Kat. -Nr. Seite
Cat. No. Page
Núm. Ref. Página
No. Réf. Page
No. Cat. Pagina

95-1063 467
95-1064 467
95-1065 467
95-1066 467
95-1071 467
95-1072 467
95-1073 467
95-1074 467
95-1075 467
95-1076 467
95-1081 467
95-1082 467
95-1083 467
95-1084 467
95-1085 467
95-1086 467
95-1091 467
95-1092 467
95-1093 467
95-1094 467
95-1095 467
95-1096 467
95-1101 460
95-1102 460
95-1103 460
95-1105 460
95-1106 460
95-1107 460
95-1120 470
95-1121 470
95-1122 470
95-1123 470
95-1124 470
95-1125 470
95-1126 470
95-1130 470
95-1131 470
95-1132 470
95-1133 470
95-1134 470
95-1135 470
95-1136 470
95-1150 471
95-1151 471
95-1152 471
95-1153 471
95-1154 471
95-1155 471
95-1156 471
95-1159 471
95-1200 437
95-1201 437
95-1202 437
95-1210 437
95-1211 437
95-1212 437

| Kat. -Nr. | Seite | Kat. -Nr. | Seite | Kat. -Nr. | Seite | Kat. -Nr. | Seite |
|------------------|--------------|------------------|--------------|------------------|--------------|------------------|--------------|
| Cat. No. | Page | Cat. No. | Page | Cat. No. | Page | Cat. No. | Page |
| Núm. Ref. | Página | Núm. Ref. | Página | Núm. Ref. | Página | Núm. Ref. | Página |
| No. Réf. | Page | No. Réf. | Page | No. Réf. | Page | No. Réf. | Page |
| No. Cat. | Pagina | No. Cat. | Pagina | No. Cat. | Pagina | No. Cat. | Pagina |
| 95-1215 | 437 | 95-2005 | 442 | 96-0733 | 456 | 97-0495 | 477 |
| 95-1216 | 437 | 95-2006 | 442 | 96-0734 | 456 | 97-0501 | 484 |
| 95-1217 | 437 | 95-2007 | 442 | 96-0735 | 456 | 97-0502 | 484 |
| 95-1240 | 434 | 95-2008 | 442 | 96-0740 | 455 | 97-0503 | 484 |
| 95-1241 | 434 | 95-2009 | 442 | 96-0749 | 458 | 97-0513 | 486 |
| 95-1242 | 434 | | | 96-0750 | 458 | 97-0515 | 486 |
| 95-1244 | 434 | 96 | | 96-0800 | 458 | 97-0521 | 484 |
| 95-1245 | 434 | 96-0100 | 208 | 96-0815 | 421 | 97-0522 | 484 |
| 95-1246 | 434 | 96-0105 | 208 | 96-0817 | 458 | 97-0531 | 484 |
| 95-1250 | 435 | 96-0110 | 208 | 96-0980 | 107 | 97-0532 | 484 |
| 95-1251 | 435 | 96-0125 | 210 | 96-0985 | 107 | 97-0533 | 484 |
| 95-1252 | 435 | 96-0251 | 221 | 96-0987 | 107 | 97-0550 | 426 |
| 95-1253 | 435 | 96-0300 | 452 | 96-0988 | 107 | 97-0552 | 426 |
| 95-1254 | 435 | 96-0303 | 453 | 96-0989 | 107 | 97-0553 | 426 |
| 95-1255 | 435 | 96-0305 | 453 | 96-0990 | 108 | 97-0554 | 426 |
| 95-1260 | 436 | 96-0306 | 453 | 96-0993 | 108 | 97-0555 | 426 |
| 95-1261 | 436 | 96-0309 | 452 | | | 97-0556 | 426 |
| 95-1262 | 436 | 96-0310 | 452 | 97 | | 97-0557 | 426 |
| 95-1263 | 436 | 96-0313 | 452 | 97-0100 | 477 | 97-0558 | 426 |
| 95-1264 | 436 | 96-0315 | 453 | 97-0192 | 480 | 97-0600 | 472 |
| 95-1265 | 436 | 96-0320 | 452 | 97-0200 | 478 | 97-0601 | 472 |
| 95-1266 | 436 | 96-0349 | 454 | 97-0201 | 478 | 97-0602 | 472 |
| 95-1267 | 436 | 96-0350 | 454 | 97-0202 | 478 | 97-0620 | 472 |
| 95-1268 | 436 | 96-0351 | 454 | 97-0203 | 478 | 97-0621 | 472 |
| 95-1290 | 441 | 96-0352 | 454 | 97-0220 | 479 | 97-0622 | 472 |
| 95-1310 | 439 | 96-0355 | 455 | 97-0225 | 479 | 97-0641 | 472 |
| 95-1311 | 439 | 96-0357 | 455 | 97-0290 | 479 | 97-0645 | 472 |
| 95-1312 | 439 | 96-0370 | 456 | 97-0300 | 480 | 97-0646 | 472 |
| 95-1313 | 439 | 96-0371 | 456 | 97-0306 | 480 | 97-0648 | 472 |
| 95-1321 | 444 | 96-0380 | 456 | 97-0370 | 482 | 97-0660 | 474 |
| 95-1322 | 444 | 96-0580 | 197 | 97-0371 | 482 | 97-0661 | 474 |
| 95-1323 | 444 | 96-0581 | 197 | 97-0372 | 482 | 97-0662 | 474 |
| 95-1324 | 444 | 96-0582 | 197 | 97-0373 | 482 | 97-0663 | 474 |
| 95-1325 | 444 | 96-0583 | 197 | 97-0374 | 482 | 97-0664 | 474 |
| 95-1326 | 444 | 96-0584 | 197 | 97-0375 | 482 | 97-0665 | 474 |
| 95-1327 | 444 | 96-0590 | 197 | 97-0380 | 481 | 97-0666 | 474 |
| 95-1328 | 444 | 96-0591 | 197 | 97-0382 | 481 | 97-0667 | 474 |
| 95-1329 | 444 | 96-0592 | 197 | 97-0390 | 481 | 97-0668 | 474 |
| 95-1330 | 444 | 96-0593 | 197 | 97-0410 | 485 | 97-0669 | 474 |
| 95-1331 | 444 | 96-0594 | 197 | 97-0415 | 485 | 97-0670 | 473 |
| 95-1332 | 444 | 96-0600 | 196 | 97-0430 | 485 | 97-0672 | 473 |
| 95-1333 | 444 | 96-0602 | 196 | 97-0435 | 109 | 97-0674 | 473 |
| 95-1334 | 444 | 96-0605 | 195 | 97-0436 | 109 | 97-0676 | 473 |
| 95-1335 | 444 | 96-0620 | 194 | 97-0440 | 486 | 97-0678 | 473 |
| 95-1336 | 444 | 96-0625 | 196 | 97-0443 | 486 | 97-0680 | 473 |
| 95-1337 | 444 | 96-0628 | 196 | 97-0450 | 457 | | |
| 95-1350 | 440 | 96-0630 | 196 | 97-0452 | 457 | 98 | |
| 95-1351 | 440 | 96-0670 | 196 | 97-0456 | 457 | 98-0200 | 109 |
| 95-1352 | 440 | 96-0674 | 195 | 97-0470 | 483 | 98-0210 | 109 |
| 95-1353 | 440 | 96-0680 | 194 | 97-0471 | 483 | | |
| 95-1354 | 440 | 96-0681 | 194 | 97-0472 | 483 | 99 | |
| 95-1355 | 440 | 96-0682 | 194 | 97-0481 | 484 | 99-0099 | 631 |
| 95-2000 | 442 | 96-0683 | 194 | 97-0482 | 484 | 99-0100 | 631 |
| 95-2001 | 442 | 96-0684 | 194 | 97-0483 | 484 | 99-0101 | 631 |
| 95-2002 | 442 | 96-0685 | 194 | 97-0490 | 481 | | |
| 95-2003 | 442 | 96-0732 | 456 | 97-0493 | 477 | | |