



Ihr Fachhändler:
Your distributor:
Su distribuidor:
Votre distributeur:
Il Vs. distributore è:

LAWTON

MEDIZINTECHNIK

LAWTON GmbH & Co. KG
Württemberger Str. 23 D-78567 Fridingen/Germany
Telefon: +49 (0) 7463 99 65-0 Telefax: +49 (0) 7463 99 65-20
e-mail: info@lawton.de <http://www.lawton.de>



Ophthalmologie
Ophthalmology
Oftalmología
Ophthalmologie
Ophthalmologia

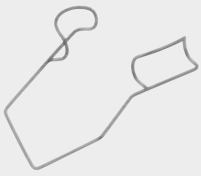

Inhaltsübersicht

Lidsperrerr.....	Seite	2 - 9
Lidhalter	Seite	10
Wundhaken und -speizer	Seite	11
Fixierringe	Seite	12
Diamantmesser.....	Seite	13 - 14
Messer	Seite	15 - 17
Spatel.....	Seite	18 - 25
Löffel.....	Seite	18 - 25
Nukleusspalter.....	Seite	26 - 27
Nukleusmanipulatoren.....	Seite	26 - 27
Haken, Häckchen.....	Seite	28 - 30
Lokalisatoren	Seite	31
Membran-Peeler.....	Seite	31
Fremdkörperinstrumente.....	Seite	32 - 33
Scheren	Seite	34 - 46
Vitrektomiezüngchen	Seite	47 - 48
Pinzetten.....	Seite	49 - 63
Bulldogklemmen.....	Seite	63
Arterienklemmen	Seite	64
Tuchklemmen.....	Seite	64
Nadelhalter	Seite	65 - 70
Saugkeile.....	Seite	71
Klingen	Seite	72
Klingenthaler und -brecher.....	Seite	72
Kanülen	Seite	73 - 81
Trephinen	Seite	82 - 83
Sonden	Seite	84 - 86
Kauter	Seite	87
Markierungsinstrumente.....	Seite	88 - 89
Stanzen.....	Seite	90 - 91
Meßinstrumente.....	Seite	92
Sterilisierbehälter	Seite	93
Verschiedenes	Seite	94 - 95
Empfohlene Instrumentensets	Seite	96 - 114

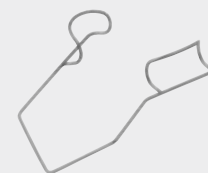

Eye Specula	Page	2 - 9
Lid Retractors	Page	10
Retractors	Page	11
Fixation Rings	Page	12
Diamond Knives	Page	13 - 14
Knives	Page	15 - 17
Spatulas	Page	18 - 25
Curettes	Page	18 - 25
Nucleus Dividing Hooks	Page	26 - 27
Hooks	Page	28 - 30
Localizers	Page	31
Membrane Peelers	Page	31
Foreign Body Instruments	Page	32 - 33
Scissors	Page	34 - 46
Vitrectomy Forceps	Page	47 - 48
Forceps	Page	49 - 63
Bulldog Clamps	Page	63
Haemostatic Forceps	Page	64
Towel Clamps	Page	64
Needle Holders	Page	65 - 70
Absorbent Strips	Page	71
Blades	Page	72
Razor Blade Holders and Breakers	Page	72
Cannulas	Page	73 - 81
Trephines	Page	82 - 83
Probes	Page	84 - 86
Cautery	Page	87
Markers	Page	88 - 89
Punches	Page	90 - 91
Measuring Instruments	Page	92
Sterilizing Boxes	Page	93
Miscellaneous	Page	94 - 95
Suggested Instrument Sets	Page	96 - 114

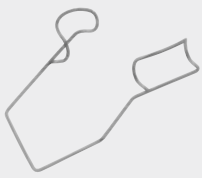

Índice

Blefarostatos.....	Página	2 - 9
Separadores de párpado.....	Página	10
Separadores.....	Página	11
Anillos de fijación.....	Página	12
Cuchillos de diamante.....	Página	13 - 14
Cuchillos.....	Página	15 - 17
Espátulas.....	Página	18 - 25
Cucharillas.....	Página	18 - 25
Separadores de núcleo.....	Página	26 - 27
Manipulador de núcleo.....	Página	26 - 27
Ganchos.....	Página	28 - 30
Localizadores.....	Página	31
Raspadores de membrana.....	Página	31
Instrumentos para cuerpos extraños.....	Página	32 - 33
Tijeras.....	Página	34 - 46
Pinzas para vitrectomía.....	Página	47 - 48
Forceps.....	Página	49 - 63
Clamps Bulldog.....	Página	63
Pinzas hemostáticas.....	Página	64
Pinzas de campo.....	Página	64
Porta-agujas.....	Página	65 - 70
Puntas absorbentes.....	Página	71
Hojas.....	Página	72
Pinzas para sujetar y romper hojas de afeitar.....	Página	72
Cánulas.....	Página	73 - 81
Terpinas.....	Página	82 - 83
Sondas.....	Página	84 - 86
Cauterio.....	Página	87
Marcadores.....	Página	88 - 89
Pinzas saca-bocados.....	Página	90 - 91
Instrumentos de medición.....	Página	92
Cajas de esterilización.....	Página	93
Diversos artículos.....	Página	94 - 95
Cajas de instrumentos sugeridos.....	Página	96 -



Blépharostats.....	Page	2 - 9
Releveurs de paupières.....	Page	10
Ecarteurs	Page	11
Anneaux de fixation	Page	12
Couteaux de diamant	Page	13 - 14
Couteaux	Page	15 - 17
Spatules.....	Page	18 - 25
Curettes	Page	18 - 25
Fendeurs du noyau.....	Page	26 - 27
Manipulateur du noyau	Page	26 - 27
Crochets	Page	28 - 30
Localisateurs	Page	31
Éplacheur de membrane	Page	31
Instruments à corps étrangers.....	Page	32 - 33
Ciseaux.....	Page	34 - 46
Pincés à vitrectomie	Page	47 - 48
Pincés	Page	49 - 63
Clamps Bulldog	Page	63
Pincés hémostatiques	Page	64
Pincés à compresses	Page	64
Porte-aiguilles.....	Page	65 - 70
Tampons absorbants	Page	71
Lames.....	Page	72
Porte-lames et brise lames.....	Page	72
Canules	Page	73 - 81
Trépan	Page	82 - 83
Sondes	Page	84 - 86
Cautére.....	Page	87
Marqueurs	Page	88 - 89
Poinçonneuses	Page	90 - 91
Instruments pour mesurer	Page	92
Boîtes pour stérilisation	Page	93
Articles divers	Page	94 - 95
Des sets d'instrumentation proposés	Page	96 - 114

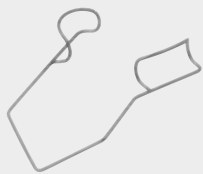

Indice

Bloccopalpebra.....	Pagina	2 - 9
Divaricatori per palpebra	Pagina	10
Ecarteurs	Pagina	11
Anelli di fissaggio.....	Pagina	12
Bisturi in diamante.....	Pagina	13 - 14
Bisturi.....	Pagina	15 - 17
Spatola	Pagina	18 - 25
Curette.....	Pagina	18 - 25
Nucleodivisore per manipolazione nucleo	Pagina	26 - 27
Uncino per manipolazione nucleo	Pagina	26 - 27
Uncini.....	Pagina	28 - 30
Localizzatori, membrana Peeler	Pagina	31
Strumentario per corpi estranei	Pagina	32 - 33
Forbici.....	Pagina	34 - 46
Pinze per vitrectomia	Pagina	47 - 48
Pinze.....	Pagina	49 - 63
Pinze Bulldog.....	Pagina	63
Pinze emostatiche	Pagina	64
Pinze fissatelo	Pagina	64
Portagli	Pagina	65 - 70
Tamponi triangolari	Pagina	71
Lamette, Pinze afferra	Pagina	72
Spezza lamette	Pagina	72
Cannule	Pagina	73 - 81
Trequarti	Pagina	82 - 83
Sonde	Pagina	84 - 86
Cauterio	Pagina	87
Marcatori.....	Pagina	88 - 89
Pinze.....	Pagina	90 - 91
Strumenti per misurare.....	Pagina	92
Cestelli per sterilizzazione.....	Pagina	93
Articoli vari.....	Pagina	94 - 95
Set di strumentario consigliati.....	Pagina	96 - 114



LAWTON

MEDIZINTECHNIK



Ophthalmologie
Ophthalmology
Oftalmología
Ophtalmologie
Ophtalmologia

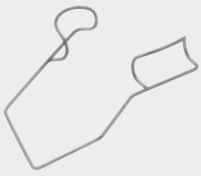

Lidsperrer
 Eye Specula
 Blefarostatos
 Blépharostats
 Bloccapalpebra



1/1

**BARRAQUER
 60-0118**

für Säuglinge
 for babies
 para bebés
 pour bébés
 per neonati



1/1

**BARRAQUER
 60-0111**

für Kinder
 for children
 para niños
 pour enfants
 per bambini



1/1

**BARRAQUER
 60-0109**



1/1

**BARRAQUER
 60-0255**

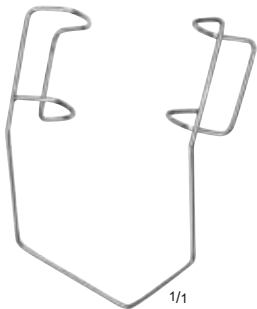

1/1

**BARRAQUER
 -FRANKFURT
 60-0124**

groß
 large
 grande
 grands
 grande

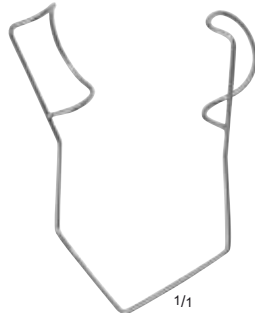

1/1

60-0115

runde Valven, nasal
 round blades, nasal
 hojas redondas, nasal
 valves rondes, nasal
 valve rotonde, nasali

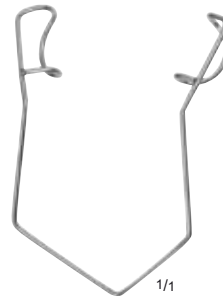

1/1

**BARRAQUER
 60-0119**

runde Valven, für Säuglinge
 round blades, for babies
 hojas redondas, para bebés
 valves rondes, pour bébés
 valve rotonde, per neonati

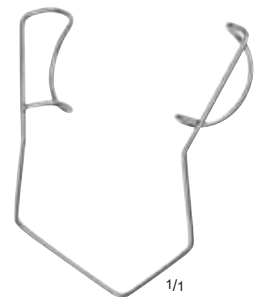

1/1

**BARRAQUER
 60-0125**

runde Valven
 round blades
 hojas redondas
 valves rondes
 valve rotonde

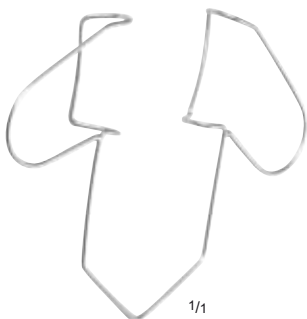

1/1

**THORNTON
 60-0131**

runde Valven, nasal
 round blades, nasal
 hojas redondas, nasal
 valves rondes, nasal
 valve rotonde, nasali



1/1

**BARRAQUER
 60-0126**



1/1

**KOCH
 60-0175**

nasal
 nasal
 nasal
 nasal
 nasale



1/1

**TAKEDA
 60-0137**

für Säuglinge
 for babies
 para bebés
 pour bébés
 per neonati



**BARRAQUER-
OOSTERHUIS
60-0235**

verstellbar, für Kinder
 adjustable, for children
 ajustable, para niños
 réglable, pour enfants
 regolabile, per bambini



**BARRAQUER-
OOSTERHUIS
60-0267**

verstellbar, runde Valven,
 für Kinder
 adjustable, round blades,
 for children
 ajustable, hojas redondas,
 para niños
 réglable, valves rondes, pour
 enfants
 regolabile, valve rotonde, per
 bambini

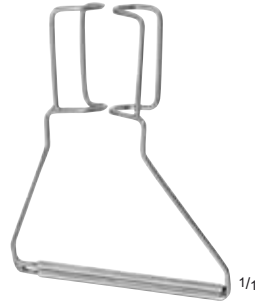

**BARRAQUER-
OOSTERHUIS
60-0237**

verstellbar
 adjustable
 ajustable
 réglable
 regolabile

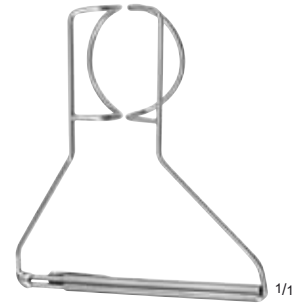

**BARRAQUER-
OOSTERHUIS
60-0265**

verstellbar, runde Valven
 adjustable, round blades
 ajustable, hojas redondas
 réglable, valves rondes
 regolabile, valve rotonde



**BARRAQUER-
OOSTERHUIS
60-0250**

verstellbar, für Kinder
 adjustable, for children
 ajustable, para niños
 réglable, pour enfants
 regolabile, per bambini



**BARRAQUER-
OOSTERHUIS
60-0252**

verstellbar
 adjustable
 ajustable
 réglable
 regolabile



**NEUHANN
60-0257**

verstellbar
 adjustable
 ajustable
 réglable
 regolabile

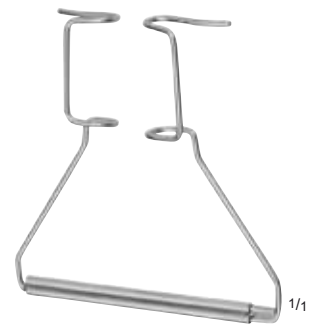

**BARRAQUER-
OOSTERHUIS-KRATZ
60-0260**

verstellbar
 adjustable
 ajustable
 réglable
 regolabile

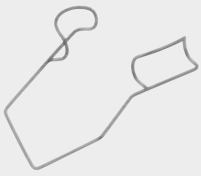

Lidsperrer
 Eye Specula
 Blefarostatos
 Blépharostats
 Bloccapalpebra



SAUER
60-0220

1/1



BANGERTER
60-0230

1/1



WEISS
60-0202

für Kinder
 for children
 para niños
 pour enfants
 per bambini

1/1



WEISS
60-0206

für Kinder
 for children
 para niños
 pour enfants
 per bambini

1/1



WEISS
60-0203

1/1



WEISS
60-0207

1/1

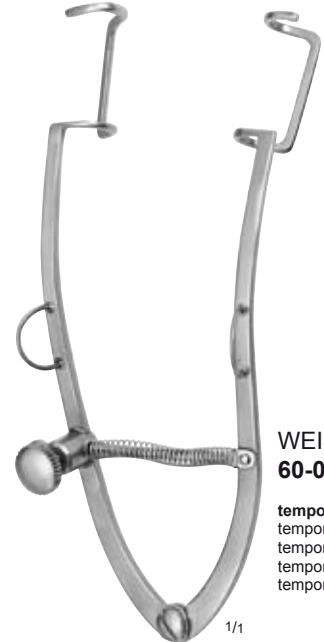

WEISS
60-0204

temporal
 temporal
 temporal
 temporal
 temporal

1/1

Lidsperrer
 Eye Specula
 Blefarostatos
 Blépharostats
 Bloccapalpebra

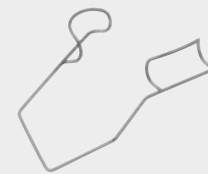

COOK
60-0214

für Säuglinge
 for babies
 para bebés
 pour bébés
 per neonati



COOK
60-0215

klein
 small
 chico
 petit
 piccolo



COOK
60-0217

mittel
 medium
 mediano
 moyen
 medio



COOK
60-0216

groß
 large
 grande
 grand
 grande



MURDOCK
60-0122

klein, links
 small, left
 pequeño, izquierdo
 petit, gauche
 piccolo, sinistro



MURDOCK
60-0123

klein, rechts
 small, right
 pequeño, derecho
 petit, droite
 piccolo, destro



MURDOCK
60-0129

links
 left
 izquierdo
 gauche
 sinistro



MURDOCK
60-0130

rechts
 right
 derecho
 droite
 destro

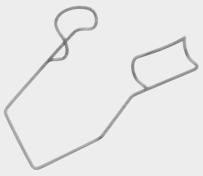

Lidsperrer
Eye Specula
Blefarostatos
Blépharostats
Bloccapalpebra

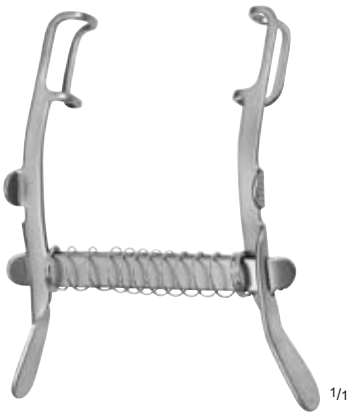

**MELLINGER
60-0178**

für Kinder
for children
para niños
pour enfants
per bambini

1/1



**MELLINGER-BEARD
60-0184**

für Kinder
for children
para niños
pour enfants
per bambini

1/1



**MELLINGER
60-0180**

1/1



**MELLINGER-BEARD
60-0190**

1/1



**PRETORI
60-0142**

1/1



**PRETORI
60-0143**

1/1

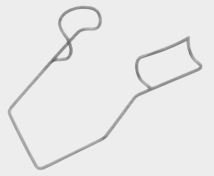

**KERSHNER
 60-0176**

nasal/temporal
 nasal/temporal
 nasal/temporal
 nasal/temporal
 nasale/temporale



**KERSHNER
 60-0177**

nasal/temporal
 nasal/temporal
 nasal/temporal
 nasal/temporal
 nasale/temporale



**LIEBERMANN-TENNANT
 60-0168**

temporal
 temporal
 temporal
 temporal
 temporale



**CASTROVIEJO
 60-0162**

14 mm Valven
 14 mm blades
 hoja de 14 mm
 14 mm valves
 valve da 14 mm



**CASTROVIEJO
 60-0161**

16 mm Valven
 16 mm blades
 hoja de 16 mm
 16 mm valves
 valve da 16 mm



**CASTROVIEJO
 60-0160**

18 mm Valven
 18 mm blades
 hoja de 18 mm
 18 mm valves
 valve da 18 mm

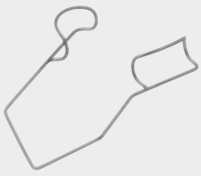

Lidsperrer
Eye Specula
Blefarostatos
Blépharostats
Bloccapalpebra

LIEBERMANN-TENNANT
60-0169

mit Absaugung
with aspiration
con aspiración
avec aspiratore
con aspiratore

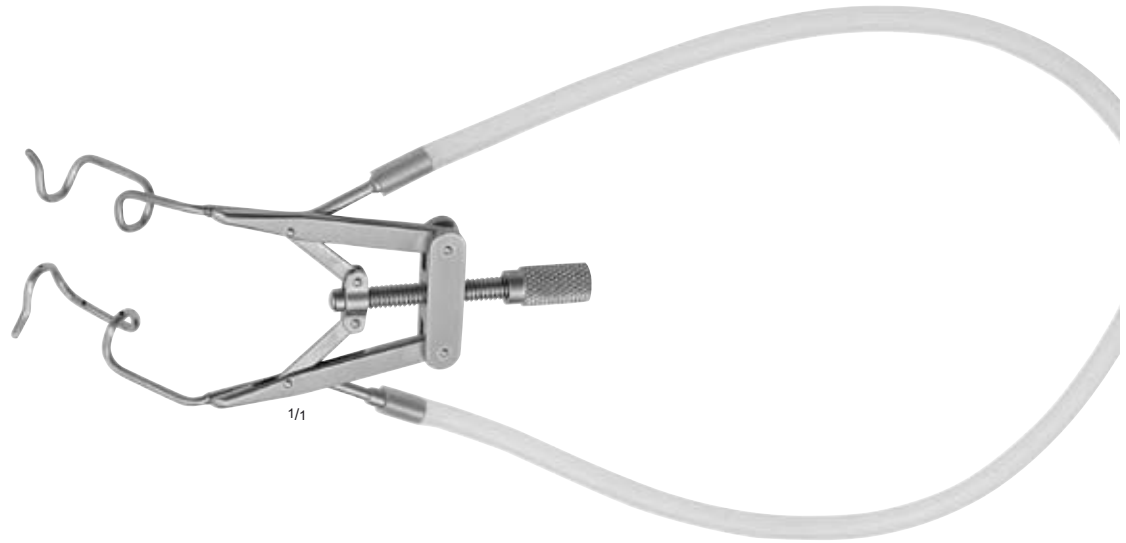

KAMANN
60-0280



PARK-MAUMENEE
60-0152

Lidsperrer
Eye Specula
Blefarostatos
Blépharostats
Bloccapalpebra

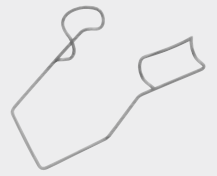

SCHOTT
60-0241

für Kinder
for children
para niños
pour enfants
per bambini

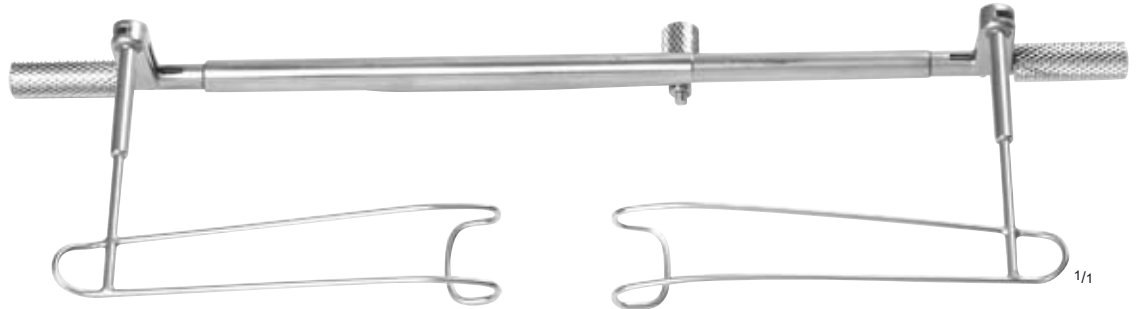

SCHOTT
60-0242

für Erwachsene
for adults
para adultos
pour adultes
per adulti



SCHOTT
60-0245

für Kinder
for children
para niños
pour enfants
per bambini



SCHOTT
60-0246

für Erwachsene
for adults
para adultos
pour adultes
per adulti

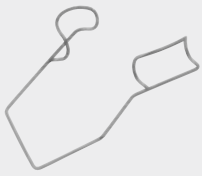

**Lidhalter**

Lid Retractors
 Separadores de párpado
 Reveurs de paupières
 Divaricatori per palpebra

Lidplatte

Lid Plate
 Placa para párpado
 Plaque à paupières
 Placca per palpebra

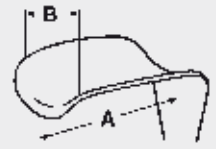

► **60-1208**
 4,5 x 8 mm (AxB)



60-1199
 9 x 10 mm (AxB)



60-1200
 9 x 12 mm (AxB)



DESMARRES
60-1199
 - **60-1208**
 14 cm, 5½"

Lidhalter
 Lid retractors
 Separadores de párpados
 Reveurs de paupières
 Divaricatori per palpebra



60-1201
 11 x 14 mm (AxB)



60-1202
 12 x 16 mm (AxB)



60-1203
 13 x 18 mm (AxB)



GIESSEN
60-1262
 13,5 cm, 5⅜"

Lidhalter
 Lid retractor
 Separador de párpado
 Reveurs de paupières
 Divaricatori per palpebra



JAEGER
60-1323
 11 cm, 4⅜"

Lidplatte, Metall
 Lid plate, metal
 Placa metálica para párpado
 Plaque à paupières en métal
 Placca per palpebra in metallo

Wundhaken

Retractors
Separadores
Ecarteurs
Divaricatori

Wundspreizer, selbsthaltend

Self-Retaining Retractors
Separadores autostáticos
Ecarteurs autostatiques
Divaricatori autostatici

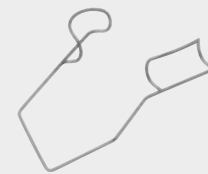
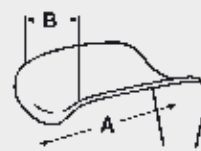

ROLLET
63-2976
13 cm, 5 1/8"

Wundhaken, scharf
Retractor, sharp
Separador, agudo
Ecarteur, tranchant
Divaricatore, tagliente



GUTHRIE
60-1221
13 cm, 5 1/8"

Hauthäkchen (Irishäkchen), scharf
Skin retractor (iris hook), sharp
Gancho para piel (gancho para iris), agudo
Crochet à plaies (Iris), tranchant
Divaricatore cutaneo (uncino per iride), acuto



GUTHRIE
60-1220
13 cm, 5 1/8"

Hauthäkchen (Irishäkchen), scharf
Skin retractor (iris hook), sharp
Gancho para piel (gancho para iris), agudo
Crochet à plaies (Iris), tranchant
Divaricatore cutaneo (uncino per iride), acuto

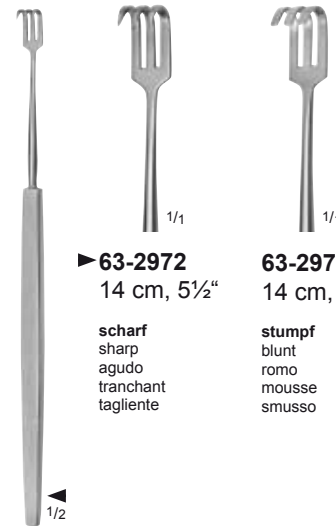

► **63-2972**
14 cm, 5 1/2"

scharf
sharp
agudo
tranchant
tagliente

63-2973
14 cm, 5 1/2"

stumpf
blunt
romo
mousse
smusso

AXENFELD
63-2972
- 63-2973

Wundhaken
Retractors
Separadores
Ecarteurs
Divaricatori

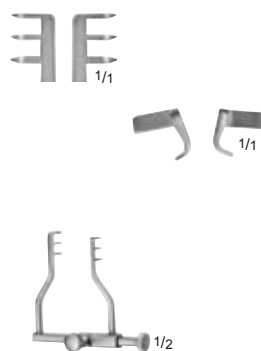

GOLDSTEIN
60-0306
3 cm, 1 1/8"

Wundspreizer, selbsthaltend
Self-retaining retractors
Separador autoestático
Ecarteurs autostatiques
Divaricatori autostatici

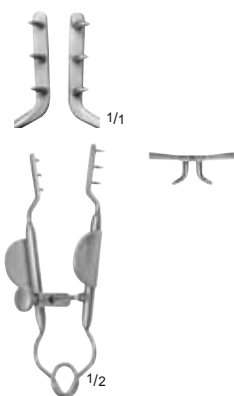

MÜLLER
60-0311
6,5 cm, 2 1/2"

Wundspreizer, selbsthaltend
Self-retaining retractors
Separador autoestático
Ecarteurs autostatiques
Divaricatori autostatici



► **21-0155**
10 cm, 4"

scharf
sharp
agudo
tranchant
tagliente

21-0156
10 cm, 4"

stumpf
blunt
romo
mousse
smusso

21-0155
- 21-0156

Wundspreizer, selbsthaltend
Self-retaining retractors
Separadores autoestáticos
Ecarteurs autostatiques
Divaricatori autostatici

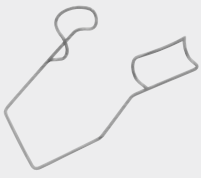

Fixierringe
 Fixation Rings
 Anillos de fijación
 Anneaux de fixation
 Anelli di fissaggio

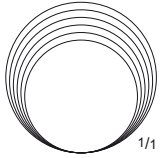

- WALTER**
60-1285 15 mm Ø
60-1286 16 mm Ø
60-1287 17 mm Ø
60-1288 18 mm Ø
60-1289 19 mm Ø
60-1290 20 mm Ø

Bulbusringe
 Bulb rings
 Anillos para bulbo
 Anneaux pour le bulbe
 Anelli per bulbo oculare



1/1
 Ø 12 mm



60-1280
 11 cm, 4 3/8"

mit konzentrischen Rillen, für Lasik
 with concentric grooves, for Lasik
 con ranuras concéntricas, para Lasik
 avec rainures concentriques, pour Lasik
 con scanalatura concentrica per Lasik



1/1
 Ø16 mm, 12 Zähne
 Ø16 mm, 12 teeth
 Ø16 mm, 12 dientes
 Ø16 mm, 12 dents
 Ø16 mm, 12 dentes

THORNTON
60-1252
 11,5 cm, 4 1/2"

1/2



1/1
 Ø16 mm, 12 Zähne
 Ø16 mm, 12 teeth
 Ø16 mm, 12 dientes
 Ø16 mm, 12 dents
 Ø16 mm, 12 dentes



THORNTON
60-1253
 11 cm, 4 3/8"

schwenkbar
 swivelable
 giratorio
 giratorio
 pivotante
 girevole

1/2

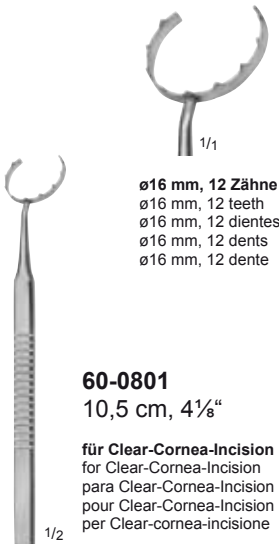

1/1
 Ø16 mm, 12 Zähne
 Ø16 mm, 12 teeth
 Ø16 mm, 12 dientes
 Ø16 mm, 12 dents
 Ø16 mm, 12 dentes

60-0801
 10,5 cm, 4 1/8"

für Clear-Cornea-Incision
 for Clear-Cornea-Incision
 para Clear-Cornea-Incision
 pour Clear-Cornea-Incision
 per Clear-cornea-incisione

1/2



1/1
 ▶ **60-0800**
 11,5 cm, 4 1/2"

Ø13 mm, 9 Zähne
 Ø13 mm, 9 teeth
 Ø13 mm, 9 dientes
 Ø13 mm, 9 dents
 Ø13 mm, 9 dentes



60-0800
 - **60-0802**

für Clear-Cornea-Incision, schwenkbar
 for Clear-Cornea-Incision, swivelable
 para Clear-Cornea-Incision, giratorio
 pour Clear-Cornea-Incision, pivotante
 per Clear-cornea-incisione, girevole

1/2



1/1
60-0802
 12 cm, 4 3/4"

Ø16 mm, 12 Zähne
 Ø16 mm, 12 teeth
 Ø16 mm, 12 dientes
 Ø16 mm, 12 dents
 Ø16 mm, 12 dentes

Diamantmesser

Diamond Knives

Cuchillos de diamante

Couteaux de diamant

Bisturi in diamante

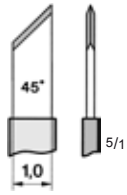
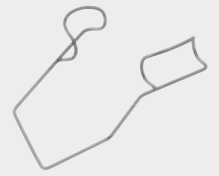

► **60-0604**

Klinge 45°, 1,0 mm
blade 45°, 1,0 mm
hoja 45°, 1,0 mm
lame 45°, 1,0 mm
lama 45°, 1,0 mm

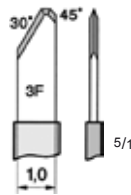

60-0617

Tri-facet Klinge, 1,0 mm
tri-facet blade, 1,0 mm
hoja Tri-Faceta, 1,0 mm
lame tri-facette, 1,0 mm
lama tri-facet, 1,0 mm

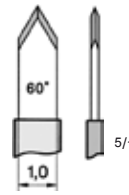

60-0608

für Parazentese, 1,0 x 0,2 mm
for paracentesis, 1,0 x 0,2 mm
para paracentesis, 1,0 x 0,2 mm
pour paracentèse, 1,0 x 0,2 mm
per paracentesi, 1,0 x 0,2 mm

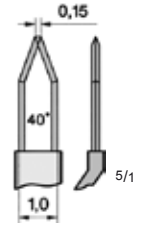

60-0616

40° abgewinkelt, 0,15 - 1,0 mm
40° angled, 0,15 - 1,0 mm
acodado de 40°, 0,15 x 1,0 mm
40° coudé, 0,15 x 1,0 mm
40° angolata, 0,15 x 1,0 mm

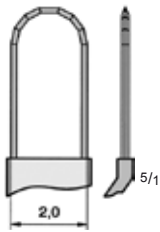

60-0609

Spatelmesser, 40° abgewinkelt,
2,0 x 0,2 mm

Spatula knife, 40° angled,
2,0 x 0,2 mm

Cuchillo-espátula, angulado 40°,
2,0 x 0,2 mm

Couteau-Spatule, 40° coudé,
2,0 x 0,2 mm

lama a spatola, 40° angolata,
2,0 x 0,2 mm

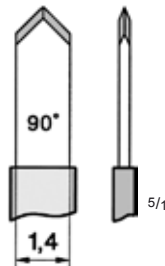

60-0610

Clear-Cornea-Incision, für bimanuelle
Phakotechnik, 1,4 x 2,0 mm

Clear-Cornea-Incision,
for bimanuel phaco, 1,4 x 2,0 mm

Clear-Cornea-Incision,
ambidestra para phaco, 1,4 x 2,0 mm

Clear-Cornea-Incision,
pour bimanuel phaco, 1,4 x 2,0 mm

Clear-cornea-incisione per
tecnica bimanuale phaco, 1,4 x 2,0 mm

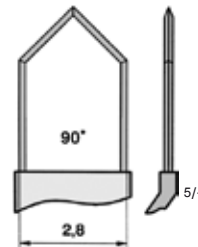

60-0611

Clear-Cornea-Incision, 35°
abgewinkelt, 2,85 x 0,2 mm

Clear-Cornea-Incision, 35°
angled, 2,85 x 0,2 mm

Clear-Cornea-Incision, angulado 35°,
2,85 x 0,2 mm

Clear-Cornea-Incision, 35° coudé,
2,85 x 0,2 mm

Clear-cornea-incisione,
35° angolata, 2,85 x 0,2 mm

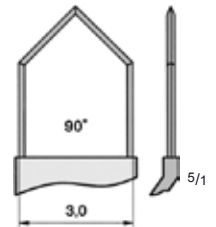

60-0612

Clear-Cornea-Incision, 35°
abgewinkelt, 3,0 x 0,2 mm

Clear-Cornea-Incision, 35° angled,
3,0 x 0,2 mm

Clear-Cornea-Incision, angulado 35°,
3,0 x 0,2 mm

Clear-Cornea-Incision, 35° coudé,
3,0 x 0,2 mm

Clear-cornea-incisione,
35° angolata, 3,0 x 0,2 mm

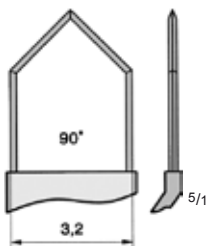

60-0613

Clear-Cornea-Incision, 35°
abgewinkelt, 3,2 x 0,2 mm

Clear-Cornea-Incision, 35° angled,
3,2 x 0,2 mm

Clear-Cornea-Incision, angulado 35°,
3,2 x 0,2 mm

Clear-Cornea-Incision, 35° coudé,
3,2 x 0,2 mm

Clear-cornea-incisione,
35° angolata, 3,2 x 0,2 mm

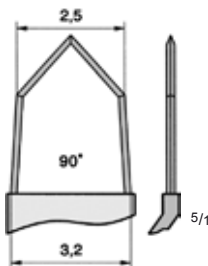

60-0614

Clear-Cornea-Incision, 35° abgewinkelt,
2° konisch, 2,85 - 3,2 mm

Clear-Cornea-Incision, 35° angled,
2° conical, 2,85 - 3,2 mm

Clear-Cornea-Incision, angulado 35°,
cónica 2°, 2,85 - 3,2 mm

Clear-Cornea-Incision, 35° coudé,
2° conique, 2,85 - 3,2 mm

Clear-cornea-incisione,
35° angolata, conica 2°, 2,85 - 3,2 mm

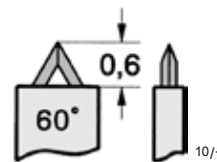

60-0618

tiefenfixiert, Lanze 60°,
Schnitttiefe 0,6 mm

pre-set depth, lance 60°,
cutting depth 0,6 mm

pre-set lanceta de 60°,
profundidad dl corte 0,6 mm

profond-fixe lance 60°,
profondeur de incision 0,6 mm

Lancia di preparazione 60°,
profondità di taglio 0,6 mm

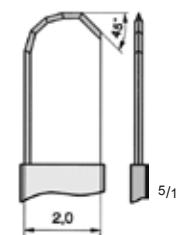

60-0619

Lid und Dupuytren
Klinge, 2,0 mm

Lid and dupuytren
blade, 2,0 mm

hoja de pápado y
dupuytren, 2,0 mm

lame paupières et
dupuytren, 2,0 mm

Lama per palpebra e
dupuytren, 2,0 mm

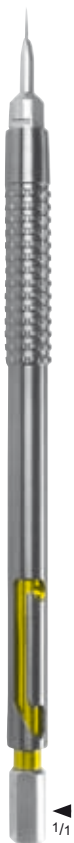

1/1

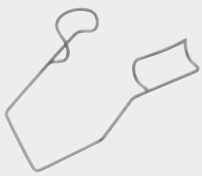

Diamantmesser
 Diamond Knives
 Cuchillos de diamante
 Couteaux de diamant
 Bisturi in diamante

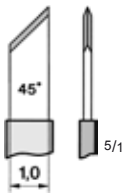

► **60-0606**

für Keratotomie, mit Mikrometer,
 Klinge 45°, 1,0 mm

for Keratotomy, with micrometer,
 blade 45°, 1,0 mm

para Queratomía, con micrómetro,
 hoja 45°, 1,0 mm

pour Kératotomie, avec micromètre,
 lame 45°, 1,0 mm

per cheratomia, con micrometro,
 lama 45°, 1,0 mm

1/1

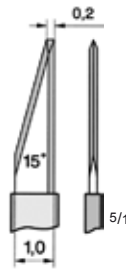

60-0607

für Keratotomie, mit Mikrometer,
 Klinge 15°, 0,2 – 0,6 mm

for Keratotomy, with micrometer,
 blade 15°, 0,2 – 0,6 mm

para Queratomía, con micrómetro,
 hoja 15°, 0,2 – 0,6 mm

pour Kératotomie, avec micromètre,
 lame 15°, 0,2 – 0,6 mm

per cheratomia, con micrometro,
 lama 45°, 0,2 - 0,6 mm

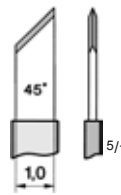

► **60-0601**

7-Stufen 0/0,3/0,4/0,5/0,6/0,8/1,0/
 2,5 mm, Klinge 45°, 1,0 mm

7-steps 0/0,3/0,4/0,5/0,6/0,8/1,0/
 2,5 mm, blade 45°, 1,0 mm

7-escalones, 0/0,3/0,4/0,5/0,6/0,8/
 1,0/2,5 mm, hoja 45°, 1,0 mm

7 crans, 0/0,3/0,4/0,5/0,6/0,8/1,0/
 2,5 mm, lame 45°, 1,0 mm

0/0,3/0,4/0,5/0,6/0,8/1,0/2,5 mm,
 lama 45°, 1,0 mm

1/1

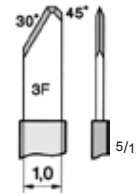

60-0602

7-Stufen 0/0,3/0,4/0,5/0,6/0,8/1,0/
 2,5 mm, Tri-facet Klinge

7-steps 0/0,3/0,4/0,5/0,6/0,8/1,0/
 2,5 mm, tri-facet blade

7-escalones, 0/0,3/0,4/0,5/0,6/0,8/
 1,0/2,5 mm, hoja Tri-Faceta

7 crans, 0/0,3/0,4/0,5/0,6/0,8/1,0/
 2,5 mm, Lame tri-facette

0/0,3/0,4/0,5/0,6/0,8/1,0/2,5 mm,
 lama tri-facet

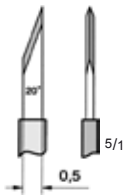

► **60-0623**

Retinamesser,
 Klinge 20°, 0,5 mm

Retinaknife,
 blade 20°, 0,5 mm

cuchillo para retina
 hoja 20°, 0,5 mm

couteau pour retina
 lame 20°, 0,5 mm

bisturi per retina,
 lama 20°, 0,5 mm

1/1

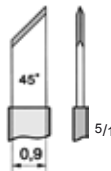

60-0624

Retinamesser,
 Klinge 45°, 0,9 mm

Retinaknife,
 blade 45°, 0,9 mm

cuchillo para retina
 hoja 45°, 0,9 mm

couteau pour retina
 lame 45°, 0,9 mm

bisturi per retina,
 lama 45°, 0,9 mm



60-0600
 14 cm, 5½ cm

Messlehre, zur Schnitttiefenprüfung
 der Diamantmesser

Measuring gauge, for measuring incision
 depth of diamond knives

Calibrador de profundidad de corte para
 cuchillo de diamante

Mesureur de la profondeur d'incision des
 couteaux de diamant

Calibro per il controllo della profondità
 d'incisione del bisturi in diamante

1/2

Augenmesser

Eye Knives

Cuchillos oculares

Couteaux oculaires

Bisturi per occhio

Skalpelli

Scalpel Handle

Mango de bisturí

Manche pour bistouri

Manice da bisturi

Sterile Skalpelling

Sterile Scalpel Blades

Hojas de bisturí, estériles

Lames de bistouris, stériles

Lame da bisturi, sterili

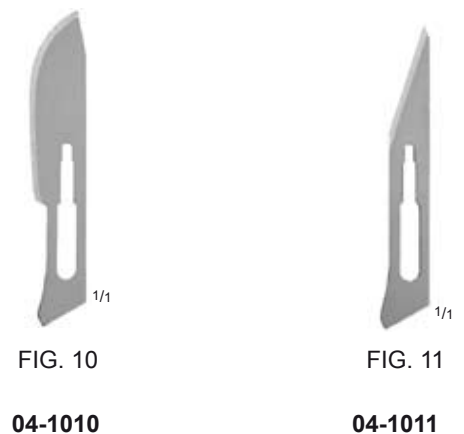
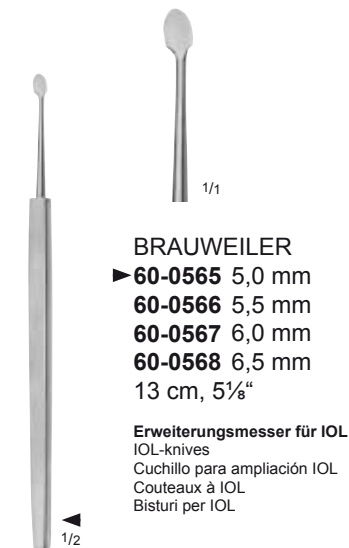
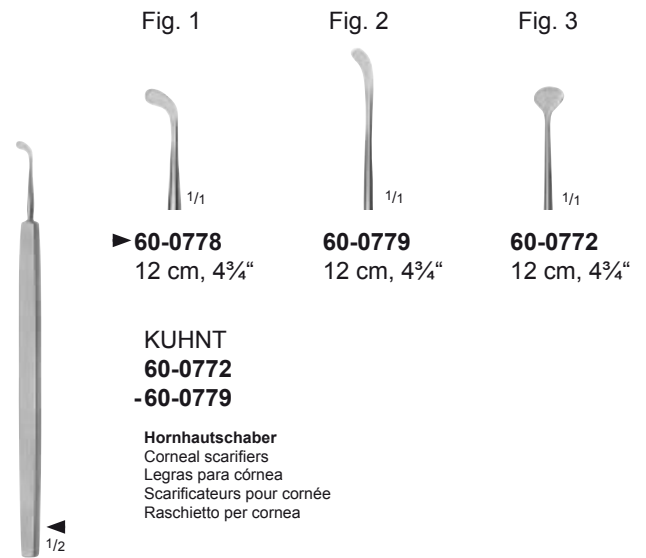
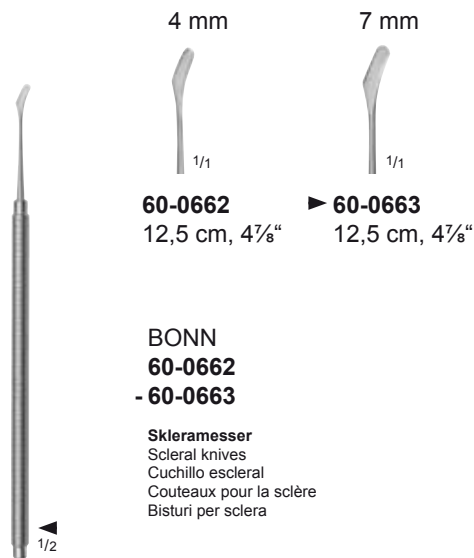
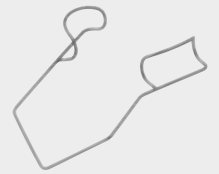

Sterile Skalpelling, in Packungen zu 100 Stück
Sterile scalpel blades, in packages of 100 pieces
Hojas de bisturí, estériles, en paquetes de 100 piezas
Lames de bistouris, stériles, en paquets de 100 pièces
Lame da bisturi, sterili, in confezioni di 100 pezzi

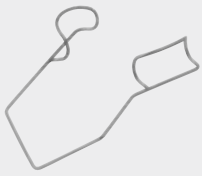

Augenmesser
 Eye Knives
 Cuchillos oculares
 Couteaux oculaires
 Bisturi per occhio

Lanzen
 Keratomes
 Lancetas
 Lances
 Lancia



fein
 delicate
 delicada
 fins
 delicato

60-0622
 12,5 cm, 4⁷/₈"

Chalazionmesser
 Chalazion knife
 Cuchillo de chalazión
 Couteaux à chalazion
 Bisturi per orzaiuolo



DARDENNE
60-0677
 12,5 cm, 4⁷/₈"

Satomesser
 Sato knife
 Cuchillo para sato
 Couteau pour sato
 Bisturi per sato



lang
 long
 largo
 longueur
 lungo

60-0684
 12,5 cm, 4⁷/₈"

Satomesser
 Sato knife
 Cuchillo para sato
 Couteau pour sato
 Bisturi per sato



60-0682
 12,5 cm, 4⁷/₈"

Satomesser
 Sato knife
 Cuchillo para sato
 Couteau pour sato
 Bisturi per sato



0°

**JAEGER-
 GRIESHABER**
60-0492
 14 cm, 5¹/₂"

Lanzenmesser mit Facettenschliff
 Keratome with facets along the cutting edge
 Cuchillo lanceolares con filos facetados
 Couteau lancéolaires avec tranchant à facette
 Couteau lancéolaires avec tranchant à facette



30°

**JAEGER-
 GRIESHABER**
60-0496
 13,5 cm, 5³/₈"

Lanzenmesser mit Facettenschliff
 Keratome with facets along the cutting edge
 Cuchillo lanceolares con filos facetados
 Couteau lancéolaires avec tranchant à facette
 Couteau lancéolaires avec tranchant à facette



45°

**JAEGER-
 GRIESHABER**
60-0510
 13 cm, 5¹/₈"

Lanzenmesser mit Facettenschliff
 Keratome with facets along the cutting edge
 Cuchillo lanceolares con filos facetados
 Couteau lancéolaires avec tranchant à facette
 Couteau lancéolaires avec tranchant à facette

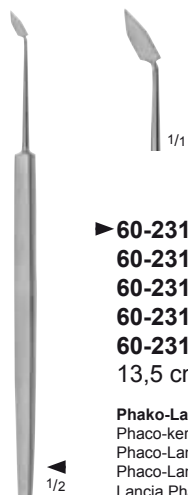

► **60-2314** 2,5 mm
60-2315 2,8 mm
60-2316 3,0 mm
60-2317 3,2 mm
60-2318 3,5 mm
 13,5 cm, 5³/₈"

Phako-Lanzen
 Phaco-keratomes
 Phaco-Lancetas
 Phaco-Lances
 Lancia Phako



MOD. HAMBURG
60-0688
 12 cm, 4³/₄"

Luftlanze
 Keratome
 Lanceta
 Couteau lancéolaire
 Bisturi lanceolato

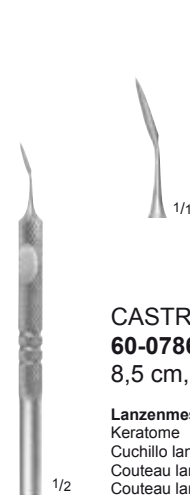

CASTROVIEJO
60-0786
 8,5 cm, 3³/₈"

Lanzenmesser
 Keratome
 Cuchillo lanceolares
 Couteau lancéolaires
 Couteau lancéolaires

Augenmesser

Eye Knives

Cuchillos oculares

Couteaux oculaires

Bisturi per occhio

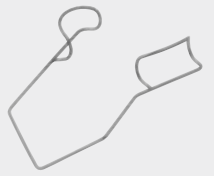

GRAEFE
60-0586
12,5 cm, 4⁷/₈"

Cystotom
Cystotome
Quistótomo
Kystitome
Cistotomo



**GUYTON-
LUNDSGAARD**
60-0620
12,5 cm, 4⁷/₈"

Sklerotom
Sclerotome
Esclerótomo
Sclérotome
Sclerotomo

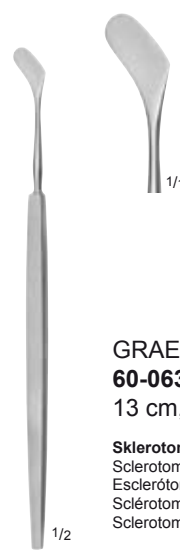

GRAEFE
60-0631
13 cm, 5¹/₈"

Sklerotom
Sclerotome
Esclerótomo
Sclérotome
Sclerotomo



KNAPP
60-0651
12 cm, 4³/₄"

Diszisionsmesser
Discission knife
Cuchillo para discisión
Couteau à discision
Bisturi



GRAEFE
60-0665
12,5 cm, 4⁷/₈"

Irismesser
Iris knife
Cuchillo para iris
Couteau pour l'iris
Bisturi per iride



SICHEL
60-0667
13 cm, 5¹/₈"

Irismesser
Iris knife
Cuchillo para iris
Couteau pour l'iris
Bisturi per iride

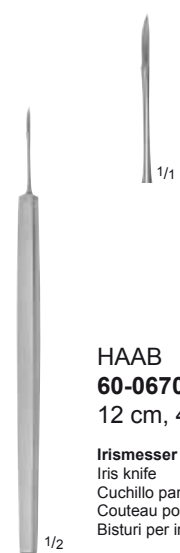

HAAB
60-0670
12 cm, 4³/₄"

Irismesser
Iris knife
Cuchillo para iris
Couteau pour l'iris
Bisturi per iride



GIRARD-SWAN
60-0675
12 cm, 4³/₄"

Irismesser
Iris knife
Cuchillo para iris
Couteau pour l'iris
Bisturi per iride



BOWMAN
60-0680
12 cm, 4³/₄"

Diszisionsnadel
Discission needle
Aguja para discisión
Aiguille à discision
Ago tagliente



BOWMAN
60-0681
12 cm, 4³/₄"

Diszisionsnadel
Discission needle
Aguja para discisión
Aiguille à discision
Ago tagliente



60-0686
12 cm, 4³/₄"

Starnadel
Cataract needle
Aguja para cataracta
Aiguille à cataracte
Ago per cataratta



BARKAN
60-0695
12 cm, 4³/₄"

Goniotomiemesser
Goniotomy knife
Cuchillo para goniotomia
Couteau à goniotomie
Bisturi goniotomo

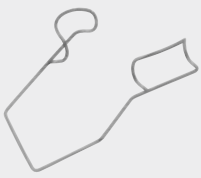

Chalazionlöffel

Chalazion Currettes
Cucharillas para chalazión
Curettes à chalazion
Curette per orzaiuolo

Lasik Instrumente

Lasik Instruments
Instrumentos para lasik
Instruments pour lasik
Strumenti per lasik

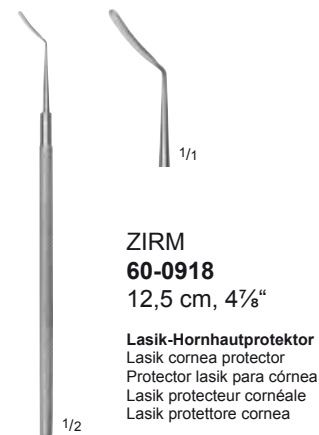
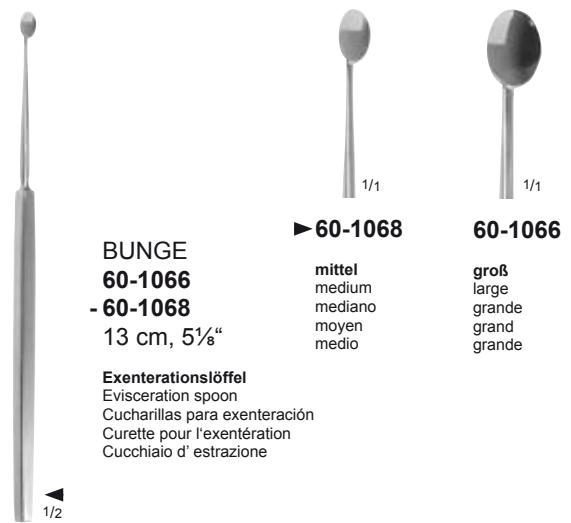
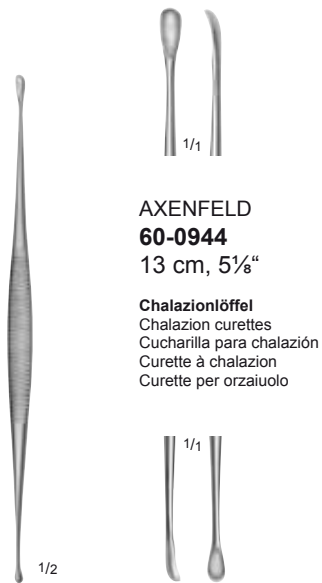
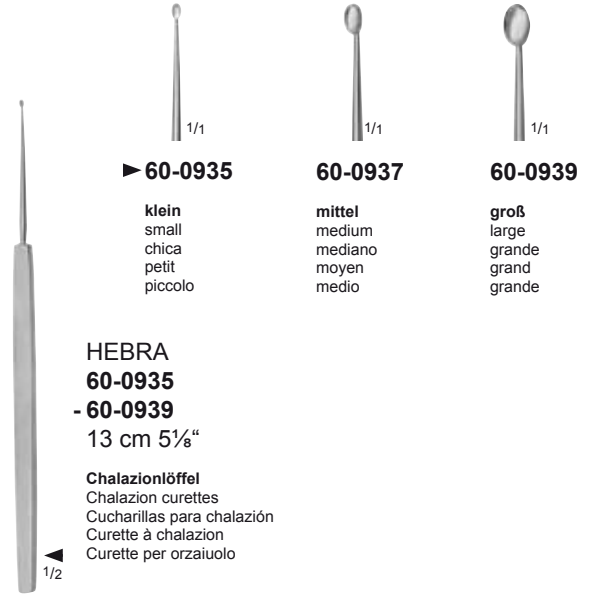
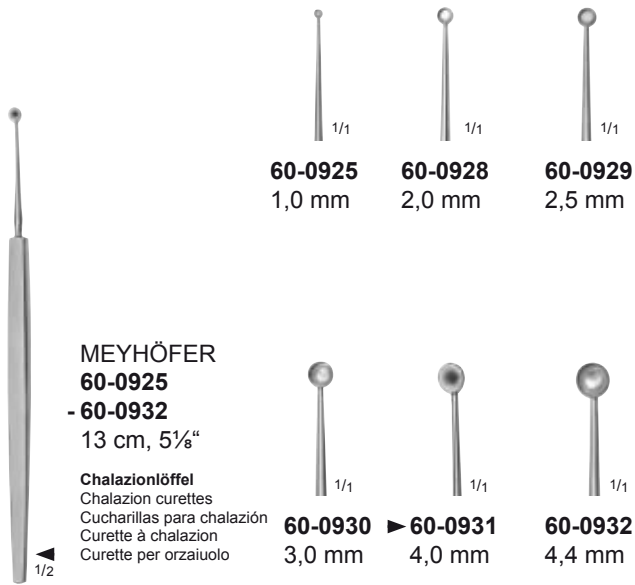

Irisspatel
 Iris Spatulas
 Espátulas para iris
 Spatules à iris
 Spatole per iride

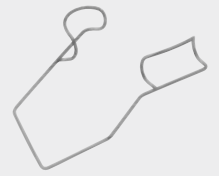

▶ **60-1481** 1,0 x 0,25 mm
60-1482 1,5 x 0,25 mm
60-1483 2,0 x 0,25 mm

BANGERTER
60-1481
 - **60-1483**
 11 cm, 4³/₈"

Irisspatel, Rundheft, abgewinkelt
 Iris spatulas, round handle, angled
 Espátulas para iris, angulada, mango redondo
 Spatules à iris, manche rond, coudé
 Spatole per iride, manico rotondo, angolata

▶ **60-1485** 1,0 x 0,25 mm
60-1486 1,5 x 0,25 mm
60-1487 2,0 x 0,25 mm

BANGERTER
60-1485
 - **60-1487**
 13 cm, 5¹/₈"

Irisspatel, abgewinkelt
 Iris spatulas, angled
 Espátulas para iris, angulada
 Spatules à iris, coudé
 Spatole per iride, angolata

WECKER
60-1419
 12 cm, 4³/₄"

TITAN LINE
WECKER
60-1406
 12 cm, 4³/₄"

TITAN LINE
WECKER
60-1493
 12 cm, 4³/₄"

konisch
 conical
 cónica
 conique
 conica

TITAN LINE
60-1480
 12 cm, 4³/₄"

konisch, besonders fein
 conical, extremely delicate
 cónica, muy delicada
 Spatule à iris, conique, très fins
 Spatola per iride, conica, fine

FRANKFURT
60-1447
 13 cm, 5¹/₈"

besonders fein
 extremely delicate
 muy delicada
 très fins
 fine

FRANKFURT
60-1448
 13 cm, 5¹/₈"

ELSCHNIG
60-1405
 13 cm, 5¹/₈"

Silber
 Silver
 Plata
 Argent
 Argento

ELSCHNIG
60-1418
 13,5 cm, 5³/₈"

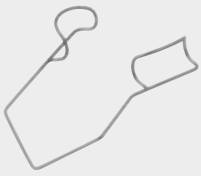

Spatel
Spatulas
Espátulas
Spatules
Spatole



D.-D.-KOCH
60-0572
10,5 cm, 4¹/₈"

Phakospatel
Phaco spatula
Espátula para phaco
Spatule pour phaco
Spatola per phaco



AMON
60-0573
10,5 cm, 4¹/₈"

Phakospatel
Phaco spatula
Espátula para phaco
Spatule pour phaco
Spatola per phaco



ELSCHNIG
60-1429
12,5 cm, 4⁷/₈"

Spatel
Spatula
Espátula
Spatule
Spatola

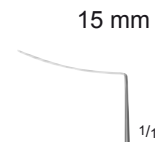

CASTROVIEJO
60-1386
13 cm, 5¹/₈"

Zyklodialysenspatel
Cyclodialysis spatula
Espátula para ciclodíalisis
Spatule à cyclodialyse
Spatola per ciclodialisi



**CASTROVIEJO-
BARRAQUER**
60-1402
9 cm, 3¹/₂"

Zyklodialysenspatel
Cyclodialysis spatula
Espátula para ciclodíalisis
Spatule à cyclodialyse
Spatola per ciclodialisi

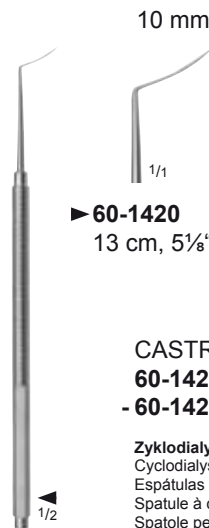

▶ **60-1420**
13 cm, 5¹/₈"



60-1421
13,5 cm, 5³/₈"

CASTROVIEJO
60-1420
- 60-1421

Zyklodialysenspatel
Cyclodialysis spatula
Espátulas para ciclodíalisis
Spatule à cyclodialyse
Spatole per ciclodialisi



BINKHORST
60-1488
11 cm, 4³/₈"

Spatel, besonders fein
Spatula, extremely delicate
Espátula, muy delicada
Spatule, très fins
Spatola, molto delicata

Spatel
Spatulas
Espátulas
Spatules
Spatole

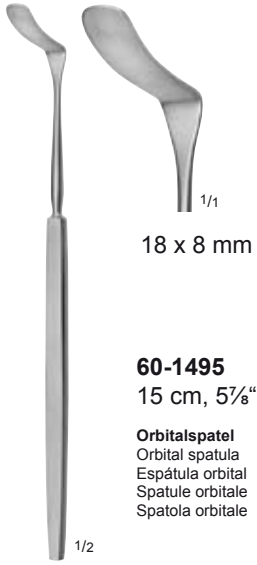
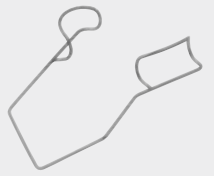

18 x 8 mm

60-1495
15 cm, 5³/₈"

Orbitalspatel
Orbital spatula
Espátula orbital
Spatule orbitale
Spatola orbitale

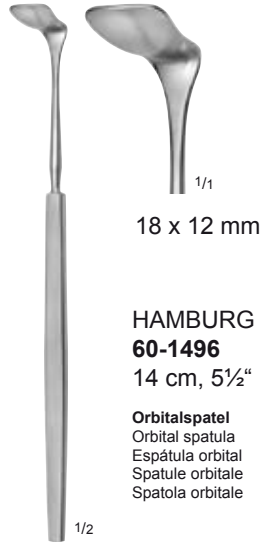

18 x 12 mm

HAMBURG
60-1496
14 cm, 5¹/₂"

Orbitalspatel
Orbital spatula
Espátula orbital
Spatule orbitale
Spatola orbitale

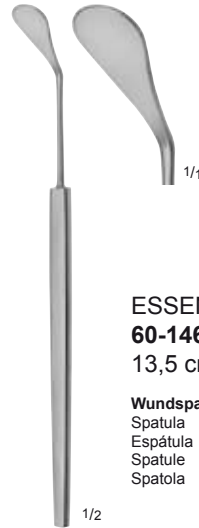

ESSEN
60-1465
13,5 cm, 5³/₈"

Wundspatel
Spatula
Espátula
Spatule
Spatola

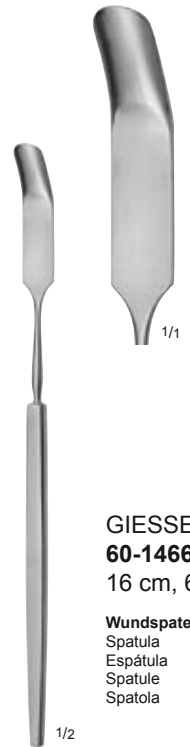

GIESSEN
60-1466
16 cm, 6¹/₄"

Wundspatel
Spatula
Espátula
Spatule
Spatola



▶ **60-1428**
8 mm

60-1705
10 mm

60-1706
12 mm

BANGERTER

60-1428

- **60-1706**

13,5 cm, 5³/₈"

Spatel
Spatulas
Espátulas
Spatules
Spatole



▶ **60-1430**
22 x 13 mm

60-1431
22 x 16 mm

60-1432
22 x 19 mm

SAUTTER

60-1430

- **60-1432**

15 cm, 5⁷/₈"

Orbitalspatel
Orbital spatulas
Espátulas orbitales
Spatules orbitales
Spatole orbitali

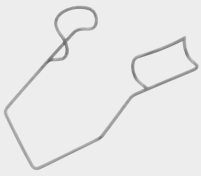

Spatel
Spatulas
Espátulas
Spatules
Spatole

Enukleationslöffel
Enucleation Spoon
Cucharilla para enucleación
Curette pour l'énucléation
Cucchiaio per enucleazione

Linsenkernrotierer
Lens Nucleus Rotator
Rotadores de lente
Rotateurs pour manipuler le noyau
Dispositivi di rotazione del centrolente

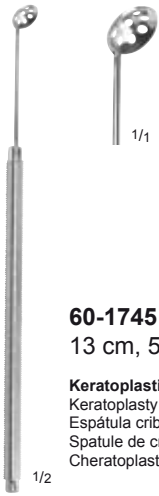

60-1745
13 cm, 5 $\frac{1}{8}$ "

Keratoplastik-Sieb spatel
Keratoplasty ethmoid spatula
Espátula cribforme para queratoplástica
Spatule de crible pour k eratoplastie
Cheratoplastica spatola perforata

1/2



WELLS
60-1055
14,5 cm, 5 $\frac{3}{4}$ "

Enukleationsl offel, gro 
Enucleation spoon, large
Cucharilla para enucleaci n, grande
Curette pour l'enucl ation, grande
Cucchiaio per enucleazione, grande

1/2

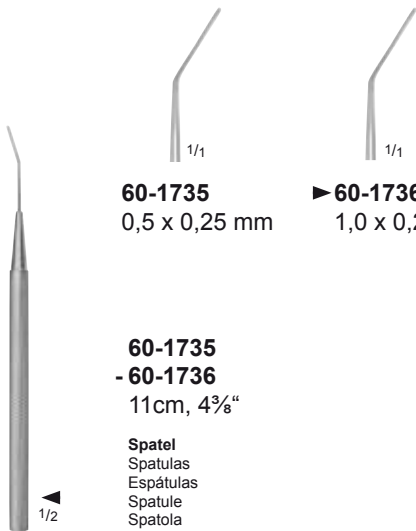

60-1735
0,5 x 0,25 mm

► **60-1736**
1,0 x 0,25 mm

60-1735
- 60-1736
11cm, 4 $\frac{3}{8}$ "

Spatel
Spatulas
Esp tulas
Spatule
Spatola

1/2



HIRSCHMANN
60-1469
12 cm, 4 $\frac{3}{4}$ "

Spatel
Spatula
Esp tula
Spatule
Spatola

1/2



NEUHANN
60-0562
12 cm, 4 $\frac{3}{4}$ "

Linsenkernrotierer
Lens nucleus rotator
Rotador de lente
Rotateur pour manipuler le noyau
Dispositivo per ruotare il nucleo della lente

1/2



NEUHANN
60-1307
12 cm, 4 $\frac{3}{4}$ "

Linsenkernrotierer und Nucleusspalter
Lens nucleus rotator and nucleus dividing hook
Rotador de lente y separador del n cleo
Crochet pour manipuler et fendre le noyau
Dispositivo di rotazione del centrolente e nucleodivisore

1/2

Membran-Spatel

Membrane Spatulas
Espátulas para membrana
Spatules à membrane
Spatoli per membrana

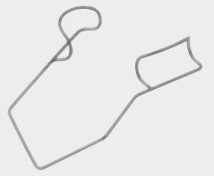

20G/0,9 mm



60-1710
12,5 cm, 4 $\frac{7}{8}$ "

mit Spitze, 5 mm abgewinkelt
with pointed tip, 5 mm angled
con punta, angulada 5 mm
avec pointe, 5 mm coudé
acuta, angolata 5 mm

1/2

20G/0,9 mm

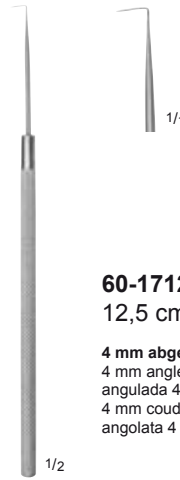

60-1712
12,5 cm, 4 $\frac{7}{8}$ "

4 mm abgewinkelt, 0,3 x 0,2 mm
4 mm angled, 0,3 x 0,2 mm
angulada 4 mm, 0,3 x 0,2 mm
4 mm coudé, 0,3 x 0,2 mm
angolata 4 mm, 0,3 x 0,2 mm

1/2

20G/0,9 mm



60-1713
12,5 cm, 4 $\frac{7}{8}$ "

4 mm abgewinkelt, 0,3 x 0,15 mm
4 mm angled, 0,3 x 0,15 mm
angulada 4 mm, 0,3 x 0,15 mm
4 mm coudé, 0,3 x 0,15 mm
angolata 4 mm, 0,3 x 0,15 mm

1/2

20G/0,9 mm



60-1717
12,5 cm, 4 $\frac{7}{8}$ "

1 mm abgewinkelt, kurze Rechen
1 mm angled, short rakes
angulada 1 mm, rastrillo corto
1 mm coudé, râteau court
angolata 1 mm, rastrello corto

1/2

20G/0,9 mm



60-1718
12,5 cm, 4 $\frac{7}{8}$ "

1 mm abgewinkelt, lange Rechen
1 mm angled, long rakes
angulada 1 mm, rastrillo largo
1 mm courbe, râteau long
angolata 1 mm, rastrello lungo

1/2

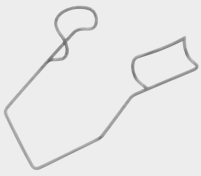

Membran-Spatel
Membrane Spatulas
Espátulas para membrana
Spatules à membrane
Spatole per membrana

20G/0.9 mm



LUCKE
60-1715
12,5 cm, 4 $\frac{7}{8}$ "

rundgebogen
round curved
curva redonda
rond courbe
tonda, curva

20G/0.9 mm



60-1720
12,5 cm, 4 $\frac{7}{8}$ "

1,5 mm abgewinkelt
1,5 mm angled
1,5 mm angulada
1,5 mm coudé
1,5 mm angolata

20G/0.9 mm



60-1721
12,5 cm, 4 $\frac{7}{8}$ "

2,5 mm abgewinkelt
2,5 mm angled
2,5 mm angulada
2,5 mm coudé
2,5 mm angolata

20G/0.9 mm



60-1723
12,5 cm, 4 $\frac{7}{8}$ "

2,0 und 4,0 mm abgewinkelt
2,0 and 4,0 mm angled
2,0 and 4,0 mm angulada
2,0 et 4,0 mm coudé
2,0 e 4,0 mm angolata

20G/0.9 mm



60-1725
12,5 cm, 4 $\frac{7}{8}$ "

5,0 mm abgewinkelt
5,0 mm angled
5,0 mm angulada
5,0 mm coudé
5,0 mm angolata

Membran-Spatelmesser

Membrane Spatulas Knives

Cuchillo Espátula para membrana

Couteaux-spatule à membrane

Spatole per membrana

Starschlingen

Cataract Loops

Asas para catarata

Anses à cataracte

Cappio per cataratta

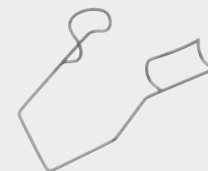

20G/0,9 mm



60-1727

12,5 cm, 4⁷/₈"

Membran-Spatelmesser, aufgeraut, abgewinkelt

Membrane spatula knife, rough, angled

Cuchillo espátula para membrana, áspera, angulada

Couteau-spatule à membrane, rugueux coudé

Bisturi a spatola per membrana, superficie grezza, angolata

1/2



60-1729

12,5 cm, 4⁷/₈"

Membran-Spatelmesser, 5 mm abgewinkelt, rundumschneidend

Membrane spatula knife, 5 mm angled, all edges sharp

Cuchillo espátula para membrana, angulada 5 mm, filo en todos los cantos

Couteau-spatule à membrane, coudé, coupant à le ronde

Bisturi a spatola per membrana, 5 mm angolato, taglio circolare

1/2

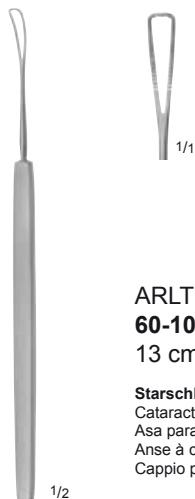

ARLT

60-1000

13 cm, 5¹/₈"

Starschlinge, gerieft

Cataract loop, serrated

Asa para catarata, estriada

Anse à cataracte, striée

Cappio per cataratta, scanalato

1/2



SNELLEN

60-1002

13 cm, 5¹/₈"

Starschlinge

Cataract loop

Asa para catarata

Anse à cataracte

Cappio per cataratta

1/2



WEBER

60-1014

13 cm, 5¹/₈"

Starschlinge, klein

Cataract loop, small

Asa para catarata, chica

Anse à cataracte, petité

Cappio per cataratta, piccolo

1/2



WEBER

60-1013

13 cm, 5¹/₈"

Starschlinge, groß

Cataract loop, large

Asa para catarata, grande

Anse à cataracte, grande

Cappio per cataratta, grande

1/2

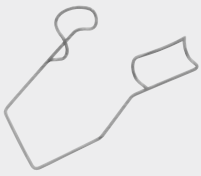

Nukleusspalter
 Nucleus Dividing Hooks
 Separadores de núcleo
 Fendeurs du noyau
 Nucleodivisore



ZIRM
60-0544
 12 cm, 4³/₄"



VOELCKER
60-0543
 11 cm, 4³/₈"

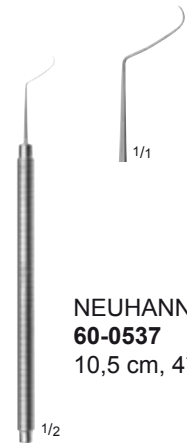

NEUHANN
60-0537
 10,5 cm, 4¹/₈"

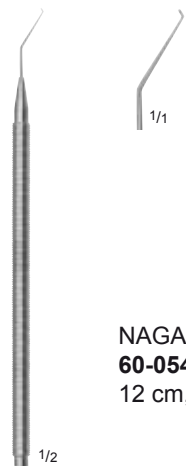

NAGAHARA
60-0549
 12 cm, 4³/₄"



NEUHANN
60-0745
 10,5 cm, 4¹/₈"

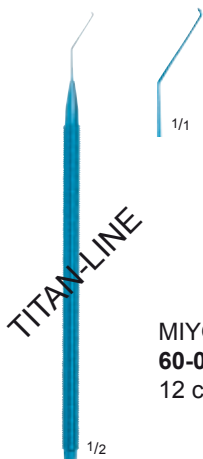

TITAN-LINE

MIYOSHI
60-0596
 12 cm, 4³/₄"

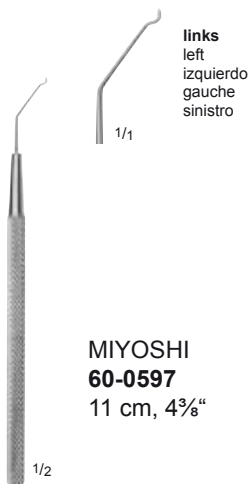

links
 left
 izquierdo
 gauche
 sinistro

MIYOSHI
60-0597
 11 cm, 4³/₈"



rechts
 right
 derecho
 droite
 destro

MIYOSHI
60-0598
 11 cm, 4³/₈"

Kapselpolierküretten

Capsule Polishing Curettes

Curetas para pulir la cápsula

Curettes de polissage de la capsule

Curetta per la lucidatura della capsula

Nukleus-Manipulator

Lens Nucleus Rotator

Manipulador de núcleo

Manipulateur du noyau

Uncino per manipolazione nucleo

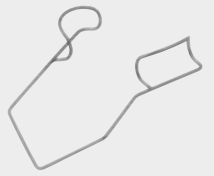

RENTSCH

60-1040

10,5 cm, 4¹/₈"

Kapselpolierkürette, abgewinkelt 135°

Capsule polishing curette, angled 135°

Cureta para pulir la cápsula, angulado 135°

Curette de polissage de la capsule, coudée 135°

Curetta per la lucidatura della capsula angolata 135°

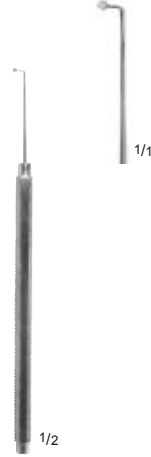

RENTSCH

60-1041

10 cm, 3⁷/₈"

Kapselpolierkürette, abgewinkelt 90°

Capsule polishing curette, angled 90°

Cureta para pulir la cápsula, angulado 90°

Curette de polissage de la capsule, coudée 90°

Curetta per la lucidatura della capsula, angolata 90°



TITAN-LINE

DRYSDALE

60-0590

12 cm, 4³/₄"

Nukleus-Manipulator und Kapselpolierer

Lens nucleus rotator and capsula polisher

Manipulador de núcleo y pulidor para cápsula

Manipulateur du noyau et polisseur de la capsule

Uncino per manipolazione nucleo e lucidatura della capsula



NEUHANN

60-1332

12,5 cm, 4⁷/₈"

Kernspalter und Irishäkchen (Push – Pull)

Nucleus dividing hook and iris hook (Push – Pull)

Separador del núcleo y gancho para iris (Push – Pull)

Fendeur du noyau et crochet à iris (Push – Pull)

Uncino separatore del nucleo e uncino per l'iride (pusch-pull)



NEUHANN

60-1336

12,5 cm, 4⁷/₈"

Kernspalter und Spatel

Nucleus dividing hook and spatula

Separador del núcleo y espátula

Fendeur du noyau et spatule

Uncino per separare il nucleo e spatola

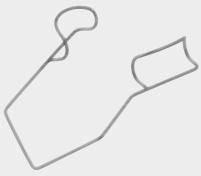

IOL Positionshäkchen

IOL Manipulator

Ganchos para manipular IOL

Crochets pour manipuler IOL

Uncini di posizione per IOL



SUZUKI
60-1109
14 cm, 5½"

IOL Positionshäkchen
IOL Manipulator
Gancho para manipular IOL
Crochet pour manipuler IOL
Uncino di posizione per IOL



FRANKFURT
60-1100
13,5 cm, 5¾"

IOL Positionshäkchen
IOL Manipulator
Gancho para manipular IOL
Crochet pour manipuler IOL
Uncino di posizione per IOL



MAINZ
60-1105
11,5 cm, 4½"

IOL Positionshäkchen
IOL Manipulator
Gancho para manipular IOL
Crochet pour manipuler IOL
Uncino di posizione per IOL



ø 0,2 mm
JACOBI
60-1102
10 cm, 3¾"

IOL Positionshäkchen
IOL Manipulator
Gancho para manipular IOL
Crochet pour manipuler IOL
Uncino di posizione per IOL



ø 0,3 mm
JACOBI
60-1103
10 cm, 3¾"

IOL Positionshäkchen
IOL Manipulator
Gancho para manipular IOL
Crochet pour manipuler IOL
Uncino di posizione per IOL



ø 0,2 mm
TITAN-LINE
SINSKEY
60-1108
12 cm, 4¾"

IOL Positionshäkchen
IOL Manipulator
Gancho para manipular IOL
Crochet pour manipuler IOL
Uncino di posizione per IOL

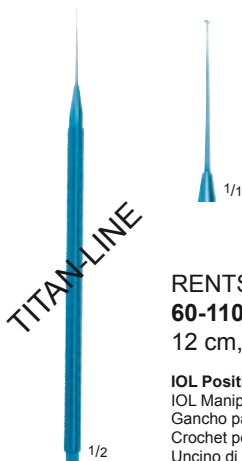

TITAN-LINE
RENTSCH
60-1107
12 cm, 4¾"

IOL Positionshäkchen
IOL Manipulator
Gancho para manipular IOL
Crochet pour manipuler IOL
Uncino di posizione per IOL



TITAN-LINE
MAINZ NEW MODEL
60-1106
11 cm, 4¾"

IOL Positionshäkchen
IOL Manipulator
Gancho para manipular IOL
Crochet pour manipuler IOL
Uncino di posizione per IOL

Irishäkchen

Iris Hooks

Ganchos para iris

Crochets à iris

Uncini per iride

Linsenbügelmanipulatoren für IOL's

Lens Loop Manipulators for IOL's

Ganchos para manipular IOL

Crochets pour manipuler IOL

Uncini per la manipolazione IOL

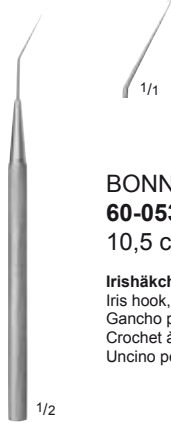
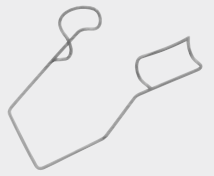

BONN
60-0533

10,5 cm, 4 $\frac{1}{8}$ "

Irishäkchen, sehr fein
Iris hook, very delicate
Gancho para iris, muy delicado
Crochet à iris, très fin
Uncino per iride, delicato



DARDENNE
60-0540

12 cm, 4 $\frac{3}{4}$ "

Irishäkchen (Push – Pull)
Iris hook (Push – Pull)
Gancho para iris (Push – Pull)
Crochet à iris (Push – Pull)
Uncino per l'iride (push-pull)



JACOBI
60-0534
12 cm, 4 $\frac{3}{4}$ "

Irishäkchen
Iris hook
Gancho para iris
Crochet à iris
Uncino per iride



LUND
60-0542
10,5 cm, 4 $\frac{1}{8}$ "

Irishäkchen
Iris hook
Gancho para iris
Crochet à iris
Uncino per iride



FRANKFURT
60-0545
14 cm, 5 $\frac{3}{4}$ "

Irishäkchen
Iris hook
Gancho para iris
Crochet à iris
Uncino per iride



BREMEN
60-0556
11,5 cm, 4 $\frac{1}{2}$ "

Linsenbügelmanipulator für IOL's
Lens loop manipulator for IOL's
Gancho para manipular IOL
Crochet pour manipuler IOL
Uncino per la manipolazione IOL

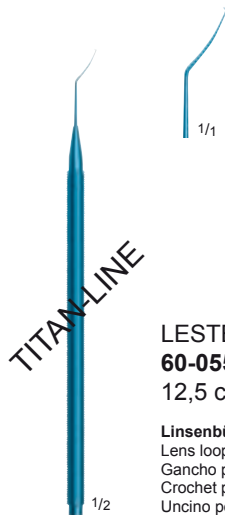

LESTER
60-0557
12,5 cm, 4 $\frac{7}{8}$ "

Linsenbügelmanipulator für IOL's
Lens loop manipulator for IOL's
Gancho para manipular IOL
Crochet pour manipuler IOL
Uncino per la manipolazione IOL



ZIRM
60-0558
11 cm, 4 $\frac{3}{8}$ "

Linsenbügelmanipulator für IOL's
Lens loop manipulator for IOL's
Gancho para manipular IOL
Crochet pour manipuler IOL
Uncino per la manipolazione IOL

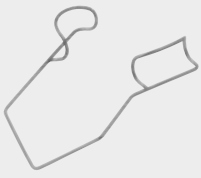

Schielhaken
 Strabismus Hooks
 Ganchos para estrabismo
 Crochets à strabisme
 Uncini per strabismo



60-1113
 12 cm, 4³/₄"

1/1



60-1110
 13 cm, 5¹/₈"

1/1



▶ **60-1111**
 14 cm, 5¹/₂"

1/1



60-1112
 14,5 cm, 5³/₄"

1/1

1/2

GRAEFE
60-1110
 - **60-1113**

Schielhaken
 Strabismus hooks
 Ganchos para estrabismo
 Crochets à strabisme
 Uncini per strabismo



1/2

HELVESTON
 ▶ **60-1185** 8 mm
60-1186 13 mm
 12,5 cm, 4⁷/₈"

Muskelhaken
 Muscle hooks
 Gancho para músculo
 Crochets musculaires
 Uncino muscolare



1/1



1/2

HELVESTON
 ▶ **60-1190** 8 mm
60-1191 10 mm
60-1192 12 mm
 14 cm, 4⁷/₈"

Muskelhaken
 Muscle hooks
 Gancho para músculo
 Crochets musculaires
 Uncino muscolare

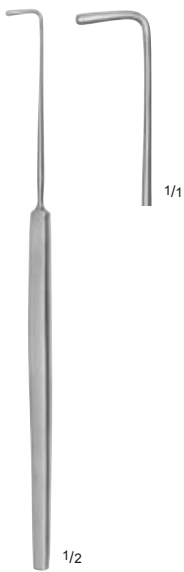

1/1

1/2

BONN
60-1170
 15 cm, 5⁷/₈"

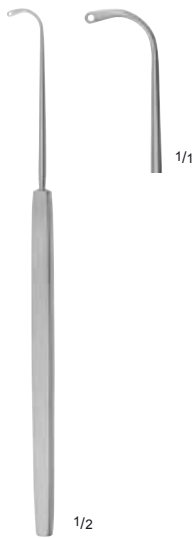

1/1

1/2

BONN
60-1171
 14 cm, 5¹/₂"

1 mm Loch
 1 mm hole
 orificio de 1 mm
 1 mm trou
 forato 1 mm



1/1

1/2

BONN
60-1173
 14,5 cm, 5³/₄"

rundgebogen
 round curved
 curvo redondo
 rond courbe
 angolato



1/1

1/2

MALBRAN
60-1117
 12,5 cm, 4⁷/₈"



1/1

1/2

HAMBURG
60-1114
 13,5 cm, 5³/₈"



1/1

1/2

JAMESON
60-1120
 13 cm, 5¹/₈"

Lokalisatoren

Localizers
Localizadores
Localisateurs
Localizzatori

Membran-Peeler

Membrane Peeler
Raspadores de membrana
Éplacheurs de membrane
Periostotomi per membrana

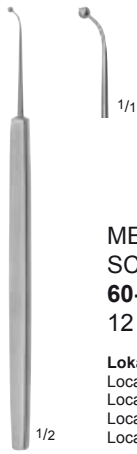
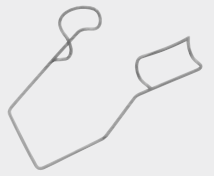

MEYER-SCHWICKERATH
60-0799

12 cm, 4³/₄"

Lokalisator
Localizer
Localizador
Localisateur
Localizzatore



LAQUA
60-0743

13 cm, 5¹/₈"

Lokalisator
Localizer
Localizador
Localisateur
Localizzatore



LAQUA
60-0742

13 cm, 5¹/₈"

Lokalisator
Localizer
Localizador
Localisateur
Localizzatore



60-1312

14 cm, 5¹/₂"

Lokalisator
Localizer
Localizador
Localisateur
Localizzatore

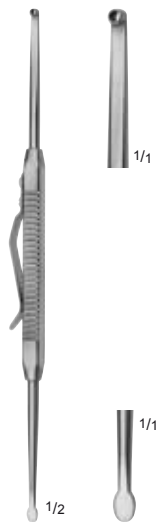

LAQUA
60-1377

13,5 cm, 5³/₈"

Lokalisator
Localizer
Localizador
Localisateur
Localizzatore

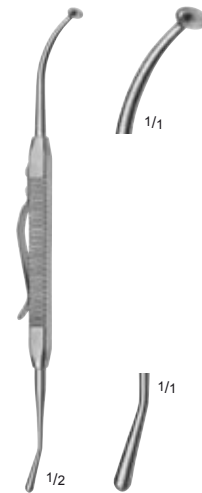

KREISSIG
60-1334

13 cm, 5¹/₈"

Lokalisator
Localizer
Localizador
Localisateur
Localizzatore

20G/0,9 mm

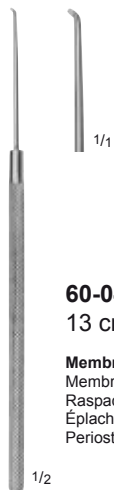

60-0460
13 cm, 5¹/₈"

Membran-Peeler, 1 mm abgewinkelt
Membrane peeler, 1 mm angled
Raspador de membrana, 1 mm angulado
Éplacheur de membrane, 1 mm coudé
Periostotomo per membrana, angolata di 1 mm

20G/0,9 mm



MORRIS-KROLL
60-0462
12,5 cm, 4⁷/₈"

Membran-Peeler, 1,5 mm abgewinkelt
Membrane peeler, 1,5 mm angled
Raspador de membrana, 1,5 mm angulado
Éplacheur de membrane, 1,5 mm coudé
Periostotomo per membrana, angolata di 1,5 mm

20G/0,9 mm



60-0464
12,5 cm, 4⁷/₈"

Membran-Peeler, stumpf
Membrane peeler, blunt
Raspador de membrana, romo
Éplacheur de membrane, mousse
Periostotomo per membrana, smussa

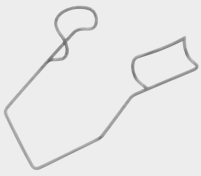

Fremdkörperinstrumente

Foreign Body Instruments

Instrumentos para cuerpos extraños

Instrumentes à corps étrangers

Strumentario per corpi estranei



ELLIS

60-0877

11,5 cm, 4½"

Fremdkörpermeißel

Foreign body chisel

Espátula para cuerpos extraños

Ciseaux-burin à corps étrangers

Scalpello per corpi estranei



60-0892

11,5 cm, 4½"

Fremdkörperhohlemeißel

Foreign body gouge

Gubia para cuerpos extraños

Gouge à corps étrangers

Sgorbia per corpi estranei

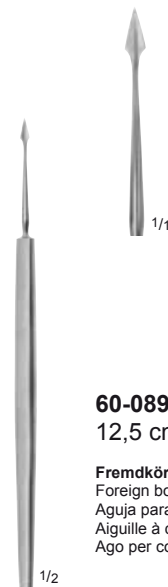

60-0895

12,5 cm, 4¾"

Fremdkörpernadel

Foreign body needle

Aguja para cuerpos extraños

Aiguille à corps étrangers

Ago per corpi estranei

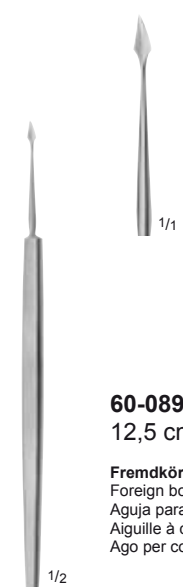

60-0896

12,5 cm, 4¾"

Fremdkörpernadel, gebogen

Foreign body needle, curved

Aguja para cuerpos extraños, curva

Aiguille à corps étrangers, courbée

Ago per corpi estranei, curvo

Fremdkörperinstrumente

Foreign Body Instruments

Instrumentos para cuerpos extraños

Instrumenti à corps étrangers

Strumentario per corpi estranei

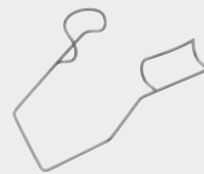

DIX
60-0855
9,5 cm, 3³/₄"

Nadel und Flachmeißel
Needle and chisel
Aguja y cincel
Aiguille et ciseaux-burin
Ago e scalpello



DIX
60-0862
9,5 cm, 3³/₄"

Nadel und Hohlmeißel
Needle and gouge
Aguja y gubia
Aiguille et gouge
Ago e sgorbia



60-0866
11 cm, 4³/₈"

Nadel und Flachmeißel
Needle and chisel
Aguja y cincel
Aiguille et ciseaux-burin
Ago e scalpello



60-0867
11 cm, 4³/₈"

Nadel und Hohlmeißel
Needle and gouge
Aguja y gubia
Aiguille et gouge
Ago e sgorbia

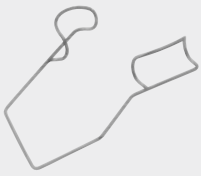

Mikro-Scheren mit flachen Federgriffen

Micro Scissors with Flat Spring Type Handles

Micro-tijeras con mangos planos de resortes

Micro-ciseaux avec manches à ressorts plats

Microforbici con manici a molla piatta



VANNAS
63-1400
8 cm, 3 $\frac{1}{8}$ "

gerade
straight
recta
droit
retta



VANNAS
63-1401
8 cm, 3 $\frac{1}{8}$ "

gebogen
curved
curva
courbe
curva



VANNAS
63-1402
8 cm, 3 $\frac{1}{8}$ "

aufgewinkelt
angled on flat
angulada hacia arriba
coudé en haut
angolata verso l'alto



VANNAS
63-1403
8 cm, 3 $\frac{1}{8}$ "

seitlich abgewinkelt
angled on side
angulada lateral
coudé sur le côté
angolata lateralmente



VANNAS
MOD. TÜBINGEN
63-1406
8,5 cm, 3 $\frac{3}{8}$ "

gerade
straight
recta
droit
retta

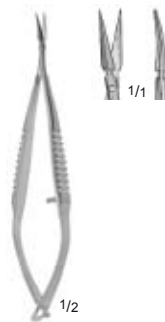

VANNAS
MOD. TÜBINGEN
63-1407
8,5 cm, 3 $\frac{3}{8}$ "

gebogen
curved
curva
courbe
curva

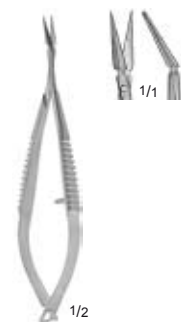

VANNAS
MOD. TÜBINGEN
63-1408
8,5 CM, 3 $\frac{3}{8}$ "

aufgewinkelt
angled on flat
angulada hacia arriba
coudé en haut
angolata verso l'alto

Mikro-Scheren mit flachen Federgriffen
 Micro Scissors with Flat Spring Type Handles
 Micro-tijeras con mangos planos de resortes
 Micro-ciseaux avec manches à ressorts plats
 Microforbici con manici a molla piatta

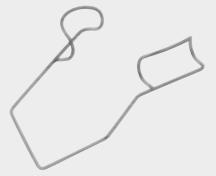

WESTCOTT
63-1330
 10 cm, 4"

schlankes Modell, stumpf-stumpf
 delicate, blunt-blunt
 modelo delicado, roma-roma
 fins, mousses-mousses
 delicata, smussa-smussa



WESTCOTT
63-0360
 12 cm, 4³/₄"

stumpf-stumpf
 blunt-blunt
 roma-roma
 mousses-mousses
 smussa-smussa

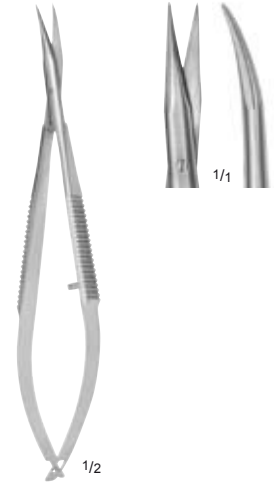

WESTCOTT
63-1300
 12,5 cm, 4⁷/₈"

spitz-spitz
 pointed-pointed
 aguda-aguda
 pointus-pointus
 acuta-acuta

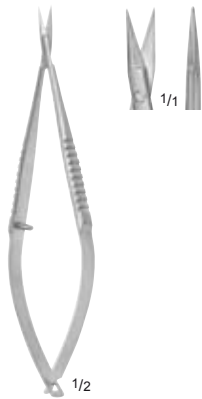

63-1430
 10 cm, 4"

spitz-spitz
 pointed-pointed
 aguda-aguda
 pointus-pointus
 acuta-acuta



63-1431
 10 cm, 4"

spitz-spitz
 pointed-pointed
 aguda-aguda
 pointus-pointus
 acuta-acuta

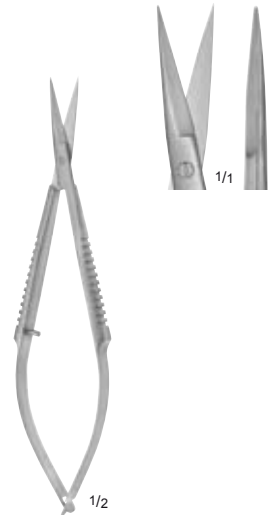

63-1432
 12 cm, 4³/₄"

spitz-spitz
 pointed-pointed
 aguda-aguda
 pointus-pointus
 acuta-acuta

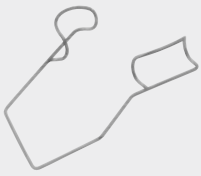

Mikro-Scheren mit flachen Federgriffen

Micro Scissors with Flat Spring Type Handles

Micro-tijeras con mangos planos de resortes

Micro-ciseaux avec manches à ressorts plats

Microforbici con manici a molla piatta

9 mm

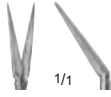

1/2

63-1337

8 cm, 3 1/8"

nach oben gebogen
angled on flat
curva hacia arriba
courbes en haut
curva verso l'alto

11 mm



1/2

63-1338

8 cm, 3 1/8"

nach oben gebogen
angled on flat
curva hacia arriba
courbes en haut
curva verso l'alto

11 mm



1/2

63-1344

8 cm, 3 1/8"

leicht gebogen
slightly curved
ligeramente curva
légèrement courbes
leggermente curva

10 mm



1/2

63-1342

10 cm, 3 7/8"

13 mm



1/2

63-1346

8 cm, 3 1/8"

13 mm



1/2

63-1347

8 cm, 3 1/8"

Mikro-Scheren mit flachen Federgriffen
 Micro Scissors with Flat Spring Type Handles
 Micro-tijeras con mangos planos de resortes
 Micro-ciseaux avec manches à ressorts plats
 Microforbici con manici a molla piatta

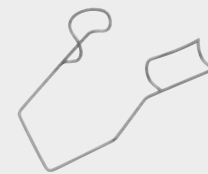

63-1434
 10 cm, 4"

leicht gebogen, stumpf-stumpf
 slightly curved, blunt-blunt
 ligeramente curva, roma-roma
 légèrement courbes, mousses-mousses
 leggermente curva, smussa-smussa

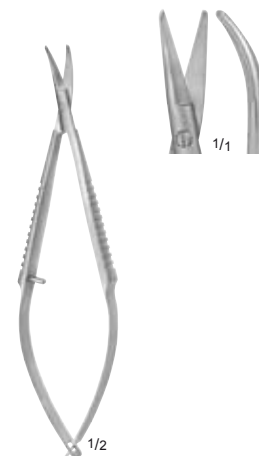

63-1433
 10 cm, 4"

nach oben gebogen, stumpf-stumpf
 angled on flat, blunt-blunt
 curva hacia arriba, roma-roma
 courbes en haut, mousses-mousses
 curva verso l'alto, smussa-smussa

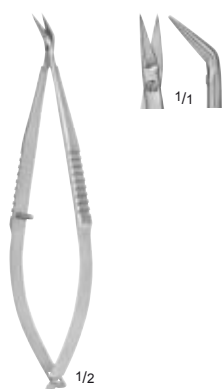

63-1439
 10 cm, 3 7/8"

stark gebogen, spitz-spitz
 strongly curved, pointed-pointed
 fuertemente curva, aguda-aguda
 moltoment courbes, pointus-pointus
 a gomito, acuta-acuta

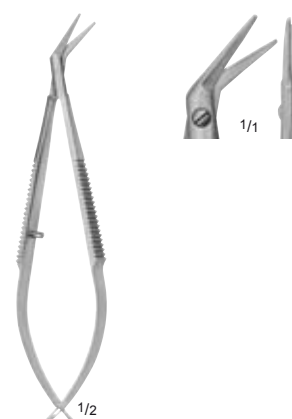

63-1071
 11 cm, 4 3/8"

kniegebogen, stumpf-stumpf
 angled to side, blunt-blunt
 acodada lateral, roma-roma
 coudés, mousses-mousses
 angolata, smussa-smussa

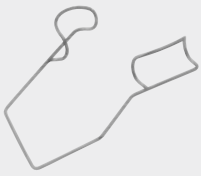

Keratomiescheren

Corneal Scissors
Tijeras para cornea
Ciseaux à cornée
Forbici per cornea

Keratoplastikscheren

Keratoplasty Scissors
Tijeras para queratoplastía
Ciseaux kératoplastique
Forbici per cheratoplastica

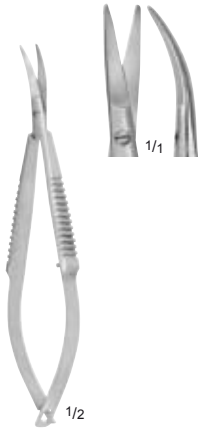

CASTROVIEJO

63-1003

10 cm, 4"

Keratomieschere, stark gebogen, stumpf-stumpf
Corneal scissors, strongly curved, blunt-blunt
Tijera para cornea, fuertemente curva, roma-roma
Ciseaux à cornée, moltoment courbes, mousses-mousses
Forbice per cornea, molto curva, smussa-smussa



MC PHERSON- WESTCOTT

63-1302

10 cm, 4"

Sehnenschere, leicht gebogen, spitz-spitz
Tenotomy scissors, slightly curved, pointed-pointed
Tijera para tenotomía, ligeramente curva, aguda-aguda
Ciseau à ténatomie, légèrement courbes, pointus-pointus
Forbice per tenotomia, leggermente curva, acuta-acuta



KATZIN

63-1170

10 cm, 4"

Keratoplastikschiere, rechts
Keratoplasty scissors, right
Tijera para queratoplastía, derecha
Ciseaux kératoplastique, droite
Forbice per cheratoplastica, destra



KATZIN

63-1171

10 cm, 4"

Keratoplastikschiere, links
Keratoplasty scissors, left
Tijera para queratoplastía, izquierda
Ciseaux kératoplastique, gauche
Forbice per cheratoplastica, sinistra

Hornhautscheren

Corneoscleral Scissors

Tijeras para córnea

Ciseaux à cornée

Forbici per cornea

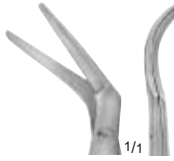
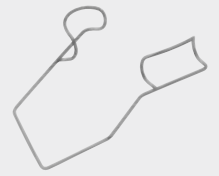

► **63-1030**
10,5 cm, 4 $\frac{1}{8}$ "

rechts
right
derecha
droite
destra

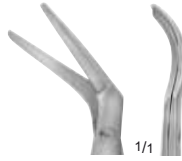

► **63-1031**
10,5 cm, 4 $\frac{1}{8}$ "

links
left
izquierda
gauche
sinistra

CASTROVIEJO

63-1030

- **63-1031**

schlanke Modelle
delicate patterns
modelos finos
modèles fins
modelli delicati



► **63-1046**
10,5 cm, 4 $\frac{1}{8}$ "

rechts
right
derecha
droite
destra

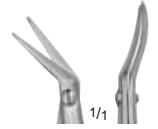

► **63-1047**
10,5 cm, 4 $\frac{1}{8}$ "

links
left
izquierda
gauche
sinistra

TROUTMAN-CASTROVIEJO

63-1046

- **63-1047**

schlanke Modelle, mit Stopp
delicate patterns, with stop
modelos finos, con seguro
modèles fins, avec stop
modelli delicati, con bloccaggio



► **63-1055**
10 cm, 4"

rechts
right
derecha
droite
destra

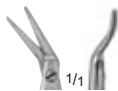

► **63-1056**
10 cm, 4"

links
left
izquierda
gauche
sinistra

TROUTMAN

63-1055

- **63-1056**

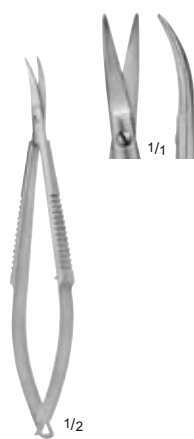

CASTROVIEJO

63-1000

10 cm, 4"

stumpf-stumpf
blunt-blunt
roma-roma
mousses-mousses
smussa-smussa

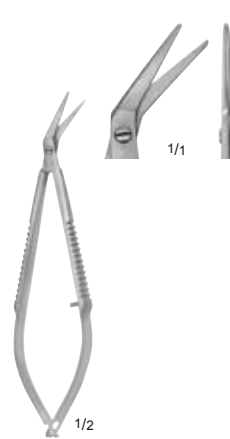

CASTROVIEJO

63-1070

9 cm, 3 $\frac{1}{2}$ "

kniegebogen, stumpf-stumpf
angled to side, blunt-blunt
acodada, roma-roma
coudés, mousses-mousses
angolata, smussa-smussa

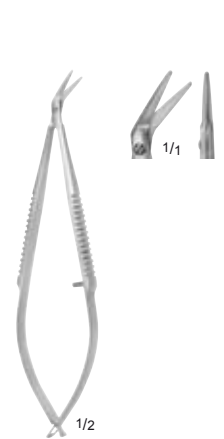

CASTROVIEJO

63-0860

10 cm, 4"

kniegebogen, stumpf-stumpf
angled to side, blunt-blunt
acodada, roma-roma
coudés, mousses-mousses
angolata, smussa-smussa

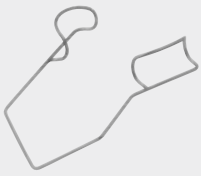

Eukleationsscheren
 Enucleation Scissors
 Tijeras para enucleación
 Ciseaux à énucléation
 Forbici per enucleazione

Fadenscheren
 Stitch Scissors
 Tijeras para ligaduras
 Ciseaux à sutures
 Forbici per legature



► **05-0112**
 14,5 cm, 5³/₄"

05-0117
 14,5 cm, 5³/₄"

05-0112
-05-0117

Standard Modelle
 Standard patterns
 modelos standard
 modèles standard
 modelli standard



► **63-0512**
 13 cm, 5¹/₈"

63-0513
 13 cm, 5¹/₈"

leicht gebogen
 slightly curved
 ligeramente curva
 légèrement courbes
 leggermente curva

stark gebogen
 strongly curved
 fuertemente curva
 moltoment courbes
 molto curva

63-0512
- 63-0513

Eukleationsscheren
 Enucleation scissors
 Tijeras para enucleación
 Ciseaux à énucléation
 Forbici per enucleazione

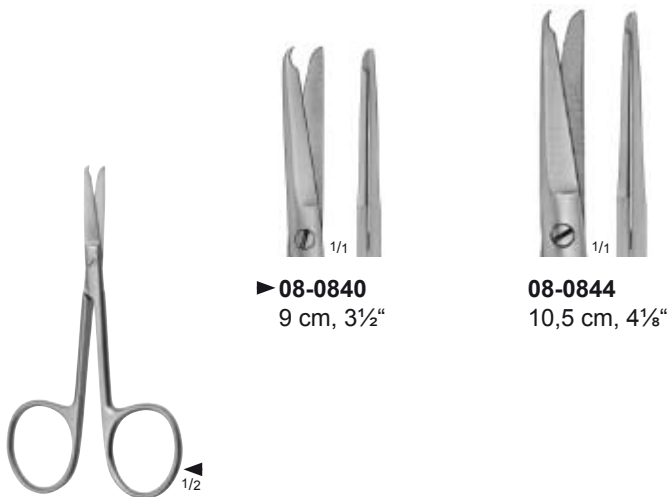

► **08-0840**
 9 cm, 3¹/₂"

08-0844
 10,5 cm, 4¹/₈"

SPENCER
08-0840
- 08-0844

Fadenscheren
 Stitch scissors
 Tijeras para sutura
 Ciseaux à sutures
 Forbici per legature

Strabismusscheren

Strabismus Scissors
Tijeras para estrabismo
Ciseaux à strabisme
Forbici per strabismo

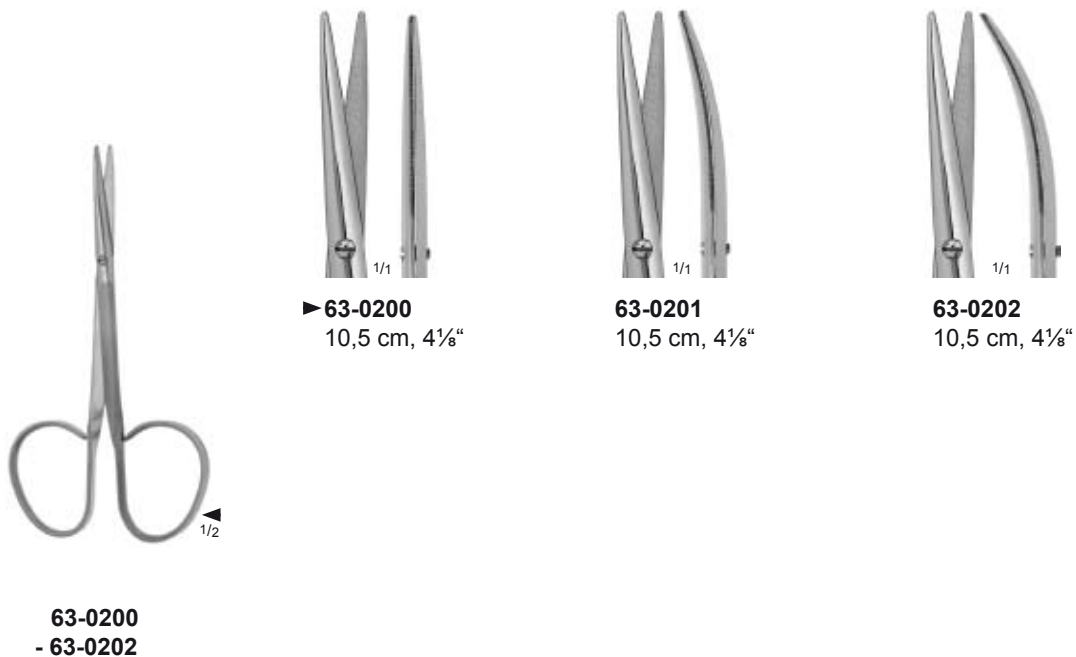
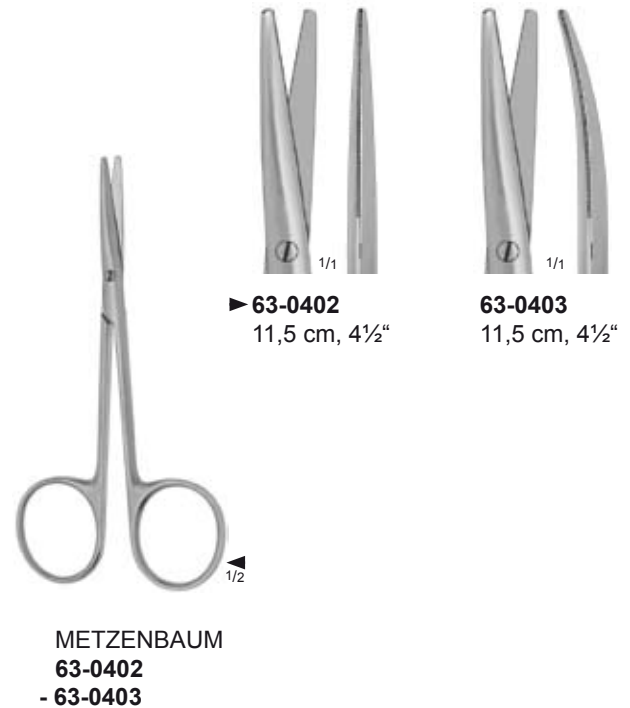
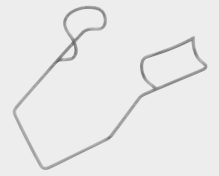

mit flachen Branchen und großen ergonomischen Ringen
with flat shanks and large ergonomical rings
con ramas planas y anillos ergonómicos grandes
avec branches plates et grands anneaux ergonomiques
con fusto piatto e grandi anelli ergonomici

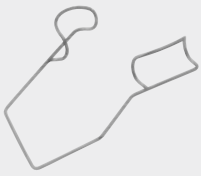

Iridektomiescheren
 Iridectomy Scissors
 Tijeras para iridectomía
 Ciseaux à iridectomie
 Forbici per iride

7 mm



WECKER
63-0824
 11 cm, 4 1/4"

spitz-spitz
 pointed-pointed
 aguda-aguda
 pointus-pointus
 acuta-acuta

7 mm



WECKER
63-0825
 11 cm, 4 1/4"

spitz-stumpf, rechts
 pointed-blunt, right
 aguda-roma, derecha
 pointus-mousses, droite
 acuta-smussa, destra

7 mm



WECKER
63-0826
 11 cm, 4 1/4"

spitz-stumpf, links
 pointed-blunt, left
 aguda-roma, izquierda
 pointus-mousses, gauche
 acuta-smussa, sinistra

7 mm

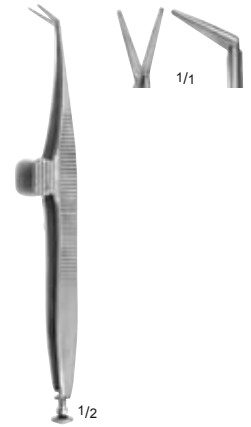

WECKER
63-0827
 11 cm, 4 1/4"

stumpf-stumpf
 blunt-blunt
 roma-roma
 mousses-mousses
 smussa-smussa

11 mm



WECKER
63-0831
 11cm, 4 1/4"

spitz-spitz
 pointed-pointed
 aguda-aguda
 pointus-pointus
 acuta-acuta

11 mm

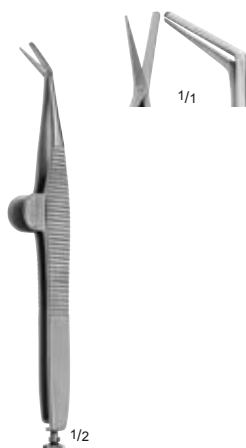

WECKER
63-0830
 11cm, 4 1/4"

spitz-stumpf, rechts
 pointed-blunt, right
 aguda-roma, derecha
 pointus-mousses, droite
 acuta-smussa, destra

11 mm

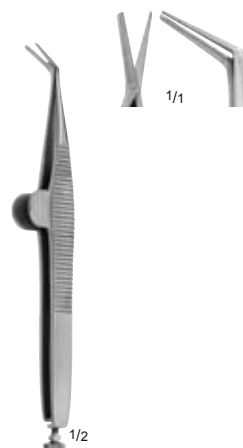

WECKER
63-0829
 11cm, 4 1/4"

spitz-stumpf, links
 pointed-blunt, left
 aguda-roma, izquierda
 pointus-mousses, gauche
 acuta-smussa, sinistra

11 mm

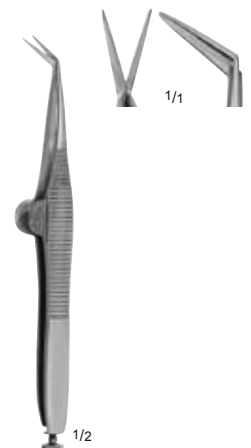

WECKER
63-0832
 11cm, 4 1/4"

stumpf-stumpf
 blunt-blunt
 roma-roma
 mousses-mousses
 smussa-smussa

Iridektomiescheren
 Iridectomy Scissors
 Tijeras para iridectomía
 Ciseaux à iridectomie
 Forbici per iride

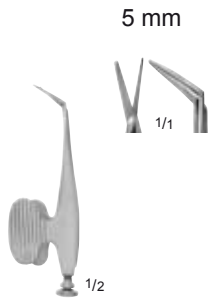
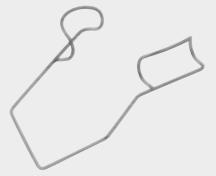

BARRAQUER
63-0852
 5,5 cm, 2¹/₈"

stumpf-stumpf
 blunt-blunt
 roma-roma
 mousses-mousses
 smussa-smussa

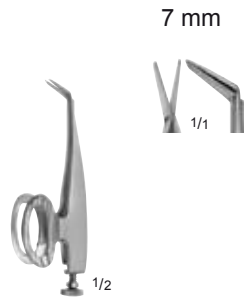

BARRAQUER
63-0851
 5,5 cm, 2¹/₈"

stumpf-stumpf
 blunt-blunt
 roma-roma
 mousses-mousses
 smussa-smussa

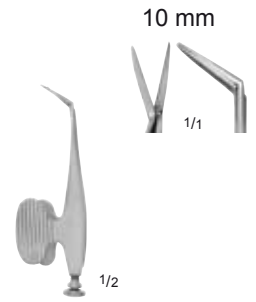

BARRAQUER
63-0850
 5,5 cm, 2¹/₈"

stumpf-stumpf
 blunt-blunt
 roma-roma
 mousses-mousses
 smussa-smussa



NOYES
63-0720
- 63-0722



► **63-0720**
 11,5 cm, 4¹/₂"

spitz-spitz
 pointed-pointed
 aguda-aguda
 pointus-pointus
 acuta-acuta



63-0721
 11,5 cm, 4¹/₂"

spitz-stumpf
 pointed-blunt
 aguda-roma
 pointus-mousses
 acuta-smussa



63-0722
 11,5 cm, 4¹/₂"

stumpf-stumpf
 blunt-blunt
 roma-roma
 mousses-mousses
 smussa-smussa

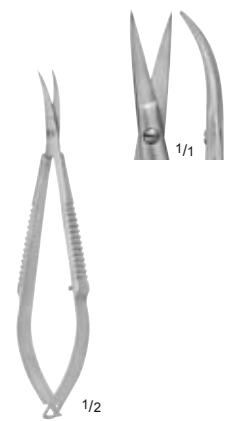

CASTROVIEJO
63-0800
 9,5 cm, 3³/₄"

spitz-spitz
 pointed-pointed
 aguda-aguda
 pointus-pointus
 acuta-acuta

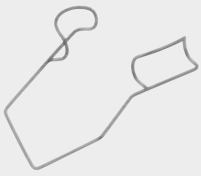

Feine chirurgische Scheren

Delicate Surgical Scissors
Tijeras finas para cirugía
Ciseaux chirurgicaux fins
Forbici delicate per chirurgia

Sehnenscheren

Tenotomy Scissors
Tijeras para tenotomía
Ciseaux à ténonomie
Forbici per tenotomia



05-0308
- **05-0321**



05-0308
8 cm, 3 $\frac{1}{8}$ "



05-0310
9 cm, 3 $\frac{1}{2}$ "



► **05-0314**
10,5 cm, 4 $\frac{1}{8}$ "



05-0320
11,5 cm, 4 $\frac{1}{2}$ "



05-0309
8 cm, 3 $\frac{1}{8}$ "



05-0311
9 cm, 3 $\frac{1}{2}$ "



05-0315
10,5 cm, 4 $\frac{1}{8}$ "



05-0321
11,5 cm, 4 $\frac{1}{2}$ "

Feine chirurgische Scheren • Delicate surgical scissors • Tijeras finas para cirugía • Ciseaux chirurgicaux fins • Forbici delicate per chirurgia



WALTER
63-0900
9,5 cm, 3 $\frac{3}{4}$ "

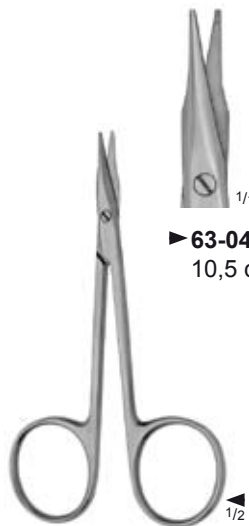

STEVENS
63-0420
- **63-0421**

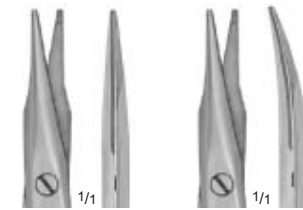

► **63-0420**
10,5 cm, 4 $\frac{1}{8}$ "



63-0421
10,5 cm, 4 $\frac{1}{8}$ "



STEVENS
63-0430
- **63-0431**

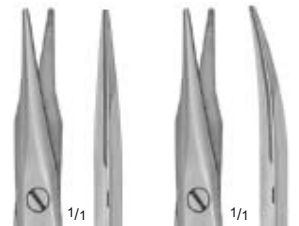

► **63-0430**
11 cm, 4 $\frac{3}{8}$ "

63-0431
11 cm, 4 $\frac{3}{8}$ "

lange Blätter
long blades
hojas largas
lames longues
lama lunga

Sehnenscheren • Tenotomy scissors • Tijeras para tenotomía • Ciseaux à ténonomie • Forbici per tenotomia

Augenscheren
 Eye Scissors
 Tijeras oculares
 Ciseaux oculaires
 Forbici oculari

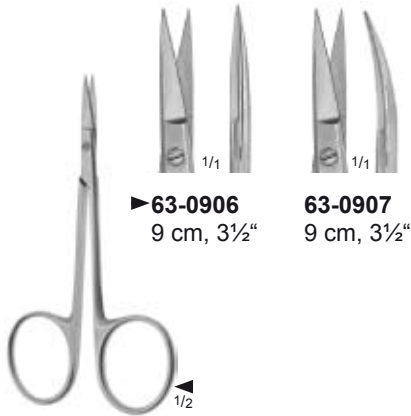
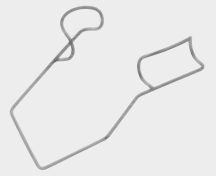

► **63-0906**
9 cm, 3½"
63-0907
9 cm, 3½"

63-0906
- **63-0907**

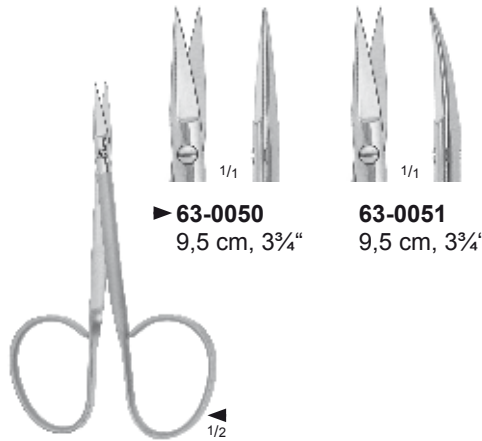

► **63-0050**
9,5 cm, 3¾"
63-0051
9,5 cm, 3¾"

63-0050
- **63-0051**

mit flachen Branchen und großen ergonomischen Ringen
 with flat shanks and large ergonomical rings
 con ramas planas y con anillos ergonómicos grandes
 avec branches plates et grands anneaux ergonomiques
 con fusto piatto e grandi anelli ergonomici



► **63-0010**
10,5 cm, 4⅛"
63-0011
10,5 cm, 4⅛"

63-0010
- **63-0011**

mit flachen Branchen und großen ergonomischen Ringen
 with flat shanks and large ergonomical rings
 con ramas planas y con anillos ergonómicos grandes
 avec branches plates et grands anneaux ergonomiques
 con fusto piatto e grandi anelli ergonomici

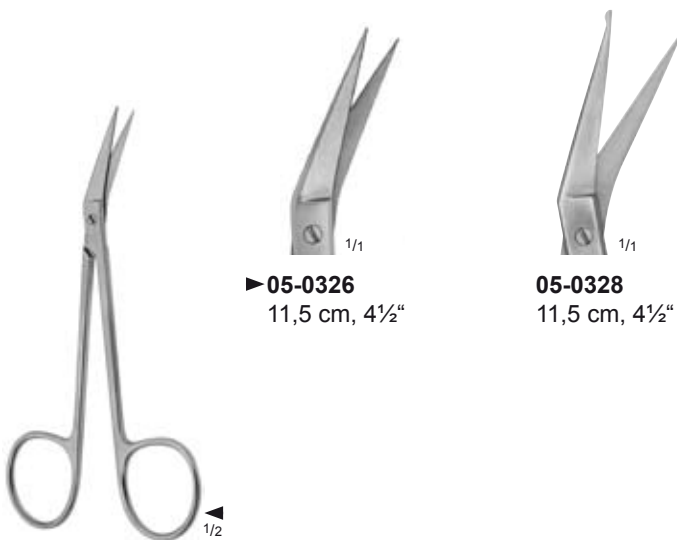

► **05-0326**
11,5 cm, 4½"

05-0328
11,5 cm, 4½"

05-0326
- **05-0328**



GRAEFE
63-0335
 10,5 cm, 4⅛"

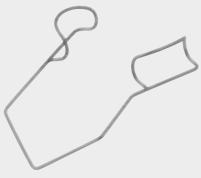

Trabekularscheren
 Trabeculum Scissors
 Tijeras trabeculares
 Ciseaux à trabeculo
 Forbici per trabecolo

Scheren für die vorderen Synechien
 Anterior Chamber Synechia Scissors
 Tijeras para sinequia anterior
 Ciseaux à synéchies antérieures
 Forbici di sinechia anteriore

Glaskörperscheren
 Vitreous Body Scissors
 Tijeras para vítreo
 Ciseaux à vitreum
 Forbici per vitreo

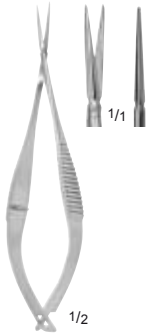

63-0530
 8,5 cm, 3³/₈"

gerade
 straight
 recta
 droits
 retta



63-0531
 8,5 cm, 3³/₈"

gebogen
 curved
 curva
 courbes
 curva

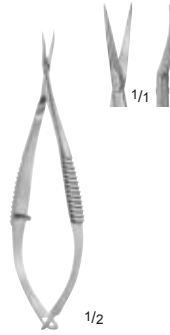

CASTROVIEJO
63-1019
 8,5 cm, 3³/₈"

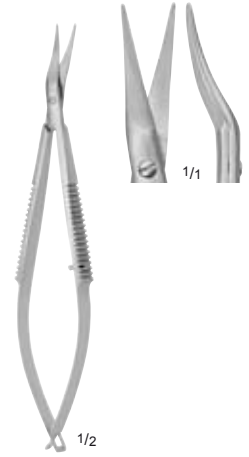

CASTROVIEJO
63-1020
 11,5 cm, 4¹/₂"

Trabekularscheren
 Trabeculum scissors
 Tijeras trabeculares
 Ciseaux à trabeculo
 Forbici per trabecolo

Augenscheren, für die vorderen Synechien
 Anterior chamber synechia scissors
 Tijeras oculares para sinequia anteriores
 Ciseaux à synéchies antérieures
 Forbici di sinechia per camera oculare anteriore



60-0810
 15 cm, 5⁷/₈"

gerade, spitz-spitz
 straight, pointed-pointed
 recta, aguda-aguda
 droit, pointus-pointus
 retta, acuta-acuta

60-0811
 15 cm, 5⁷/₈"

45° aufgewinkelt, spitz-spitz
 45° angled, pointed-pointed
 45° angulada, aguda-aguda
 45° coudés, pointus-pointus
 45° angolata, acuta-acuta

▶ 60-0813
 15 cm, 5⁷/₈"

abgewinkelt, spitz-spitz
 angled, pointed-pointed
 angulada, aguda-aguda
 coudés, pointus-pointus
 angolata, acuta-acuta

60-0815
 15 cm, 5⁷/₈"

rundgebogen, spitz-spitz
 round curved, pointed-pointed
 curva redonda, aguda-aguda
 rond courbes, pointus-pointus
 rotonda curva, acuta-acuta

Glaskörperscheren • Vitreous body scissors • Tijeras para vítreo • Ciseaux à vitreum • Forbici per vitreo

HEIMANN
60-0810
 - **60-0815**

Vitrektomie-Zängchen

Vitrectomy Forceps

Pinzas para vitrectomía

Pinces à vitrectomie

Pinze per vitrectomia

20 G/0,9 mm



62-1130

14,5 cm, 5³/₄"

Fassflächen gerieft
serrated tips
puntas estriadas
striée
rigata

20 G/0,9 mm



62-1132

14,5 cm, 5³/₄"

20 G/0,9 mm



62-1133

14,5 cm, 5³/₄"

45° abgewinkelt
45° angled
45° angulada
45° coudée
angolata 45°

20 G/0,9 mm



62-1135

14,5 cm, 5³/₄"

Membran-Peeler, 45° abgewinkelt
Membrane-peeler, 45° angled
Raspador de membrana, 45° angulada
Éplacheur de membrane, 45° coudée
Periostotomo per membrana, angolata 45°

20 G/0,9 mm



62-1137

14,5 cm, 5³/₄"

Membran-Peeler, 90° abgewinkelt
Membrane-peeler, 90° angled
Raspador de membrana, 90° angulada
Éplacheur de membrane, 90° coudée
Periostotomo per membrana, angolata 90°

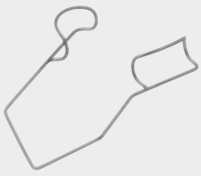

Vitrektomie-Zängchen

Vitrectomy Forceps

Pinzas para vitrectomía

Pinces à vitrectomie

Pinze per vitrectomia



1/2



1/1

20 G/0,9 mm

62-1120 0,2 x 0,05 mm

62-1122 0,3 x 0,05 mm

62-1124 0,2 x 0,10 mm

62-1126 0,3 x 0,10 mm

14,5 cm, 5³/₄"

gerade, extra fein
straight, extremely delicate
recta, muy delicada
droit, très fin
retta, molto delicata



1/2



1/1

20 G/0,9 mm

62-1143

14,5 cm, 5³/₄"

Fassflächen gerieft
serrated tips
punta estriada
striée
rigata



1/2



1/1

20 G/0,9 mm

62-1139 45°

62-1138 90°

14,5 cm, 5³/₄"

abgewinkelt, spitz-spitz
angled, pointed-pointed
angulada, aguda-aguda
coudée, pointus-pointus
angolata, acuta-acuta



1/2



1/1

20 G/0,9 mm

62-1141

14,5 cm, 5³/₄"

Membran-Peeler
Membrane-peeler
Pelador de membrana
Éplacheur de membrane
Periostotomo per membrana

Kapsulorhexispinzetten

Capsulorhexis Forceps

Pinzas para cápsula

Pinces capsulaires

Pinze per capsula

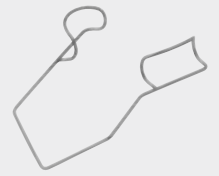

MASKET
62-1745
10,5 cm, 4 $\frac{1}{8}$ "



62-1743
10,5 cm, 4 $\frac{1}{8}$ "

extra fein
extremely delicate
muy delicada
très fins
molto delicata



62-1746
10 cm, 3 $\frac{7}{8}$ "

extra fein
extremely delicate
muy delicada
très fins
molto delicata

Kapsulorhexispinzetten • Capsulorhexis forceps • Pinzas para cápsula • Pinces pour capsulaire • Pinze per capsula



62-1740
10 cm, 3 $\frac{7}{8}$ "

extra fein
extremely delicate
muy delicada
très fins
molto delicata



KIRBY
60-1560
10 cm, 3 $\frac{7}{8}$ "

extra fein
extremely delicate
muy delicada
très fins
molto delicata



KIRBY
60-1565
10 cm, 3 $\frac{7}{8}$ "

extra fein
extremely delicate
muy delicada
très fins
molto delicata

Kapsulorhexispinzetten • Capsulorhexis forceps • Pinzas para cápsula • Pinces pour capsulaire • Pinze per capsula

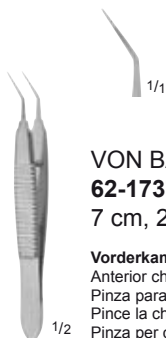

VON BARSEWISCH
62-1737
7 cm, 2 $\frac{3}{4}$ "

Vorderkammerpinzette
Anterior chamber forceps
Pinza para la cámara anterior
Pince la chambre antérieure
Pinza per camera anteriore



ARRUGA
62-1640
10 cm, 4"

Kapselpinzette, fein
Capsule forceps, delicate
Pinza para cápsula, delicada
Pince capsulaire, fine
Pinza per capsula, delicata



ARRUGA
62-1645
10 cm, 4"

Kapselpinzette
Capsule forceps
Pinza para cápsula
Pince capsulaire
Pinza per capsula

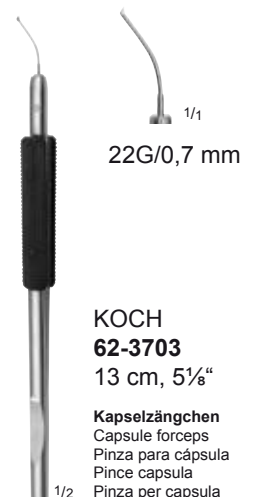

KOCH
62-3703
13 cm, 5 $\frac{1}{8}$ "

Kapselzängchen
Capsule forceps
Pinza para cápsula
Pince capsula
Pinza per capsula

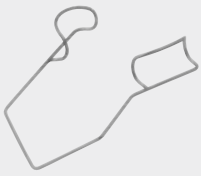

Chalazionspinzetten

Chalazion Forceps
Pinzas para chalazión
Pince à chalazion
Pinze per chalazion



AYER
62-2805
9 cm, 3½"

Chalazionspinzette
Chalazion forceps
Pinza para chalazión
Pince à chalazion
Pinza per chalazion



LAMBERT
62-2800
9 cm, 3½"

Chalazionspinzette
Chalazion forceps
Pinza para chalazión
Pince à chalazion
Pinza per chalazion

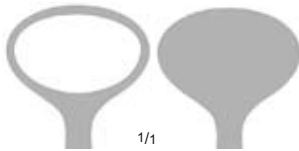

► **62-2810**
20 mm

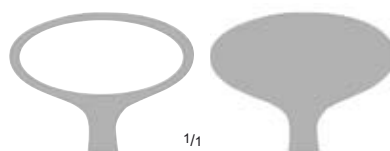

62-2811
25 mm

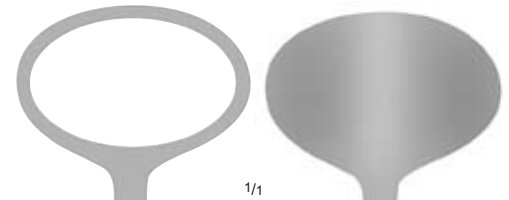

62-2812
31 mm



DESMARRES
68-2810
- **62-2812**
9 cm, 3½"

Chalazionspinzetten
Chalazion forceps
Pinzas para chalazión
Pince à chalazion
Pinze per chalazion



CAUER
62-2852
10 cm, 3⅞"

Chalazionspinzette
Chalazion forceps
Pinza para chalazión
Pince à chalazion
Pinza per chalazion



LORDAN
62-2855
9 cm, 3½"

Chalazionspinzette
Chalazion forceps
Pinza para chalazión
Pince à chalazion
Pinza per chalazion



BERKE
62-3281
11 cm, 4⅜"

Ptosispinzette
Ptosis forceps
Pinza de ptosis
Pince à ptosis
Pinza per ptosis

Augenpinzetten

Eye Forceps

Pinzas oculares

Pinces oculaires

Pinze oculari

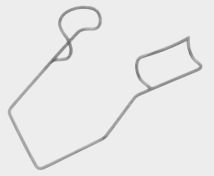

0,5 mm



► **09-0071**
9,5 cm, 3³/₄"

0,7 mm



09-0072
9,5 cm, 3³/₄"



09-0071
- **09-0072**

Feine anatomische Pinzetten
Delicate dissecting forceps
Pinzas finas de disección
Pinces fines pour dissection
Pinze anatomica per dissezione, fini

1,0 mm



09-0010
10 cm, 3⁷/₈"

1,2 mm



► **09-0073**
10 cm, 3⁷/₈"



09-0010
- **09-0073**

Feine anatomische Pinzetten
Delicate dissecting forceps
Pinzas finas de disección
Pinces fines pour dissection
Pinze anatomica per dissezione, fini

0,5 mm



► **09-0026**
10 cm, 3⁷/₈"

0,7 mm



09-0080
10 cm, 3⁷/₈"

1,0 mm



09-0020
10 cm, 3⁷/₈"

1,2 mm



09-0081
10,5 cm, 4¹/₈"



09-0020
- **09-0081**

Feine chirurgische Pinzetten, 1x2 Zähne
Delicate tissue forceps, 1x2 teeth
Pinzas finas quirúrgicas, 1x2 dientes
Pinces fines chirurgicales, 1x2 dents
Pinze fini per chirurgica, 1x2 denti

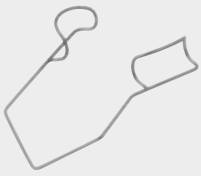

Fixierpinzetten

Fixation Forceps

Pinzas de fijación

Pinces à fixation

Pinze di fissaggio



REMKY

62-0573

8,5 cm, 3³/₈"

Keratoplastikpinzette

Keratoplasty forceps

Pinza para queratoplastía

Pince à fixation pour k eratotomie radiare

Pinze per cheratoplastica

1/2



TROUTMAN (COLIBRI)

62-0908

7,5 cm, 3"

Fixierpinzette

Fixation forceps

Pinza de fijaci n

Pince à fixation

Pinza di fissaggio

1/2



KREMER

62-0571

10,5 cm, 4¹/₈"

Fixierpinzette, mit Sperre, Gabelbreite 13,0 mm

Fixation forceps, with ratchet, width of prong 13.0 mm

Pinza de fijaci n, con cremallera, ancha de 13.0 mm

Pince à fixation, avec verrou, largeur de la dent 13,0 mm

Pinza di fissaggio con chiusura, intervallo 13,0 mm

1/2



62-0476

11 cm, 4³/₈"



► 62-0475

11 cm, 4³/₈"

62-0475

- 62-0476

Fixierpinzette, Gabelbreite 3,0 mm

Fixation forceps, width of prong 3.0 mm

Pinza de fijaci n, ancha de 3.0 mm

Pince à fixation, largeur de la dent 3,0 mm

Pinza di fissaggio, intervallo 3,0 mm

1/2



JESS

62-0507

11 cm, 4¹/₈"

Fixierpinzette

Fixation forceps

Pinza de fijaci n

Pince à fixation

Pinza di fissaggio

1/2



GRAEFE

09-0351

11 cm, 4¹/₈"

Chirurgische Pinzette, 5x6 Z hne

Tissue forceps, 5x6 teeth

Pinza quir rgica, 5x6 dientes

Pince chirurgicales, 5x6 dents

Pinza chirurgica, 5x6 denti

1/2

Fixierpinzetten
 Fixation Forceps
 Pinzas de fijación
 Pince à fixation
 Pinze di fissaggio

Fixierkrallen
 Fixation Claws
 Ganchos para fijación
 Griffe à fixation
 Uncini di fissaggio

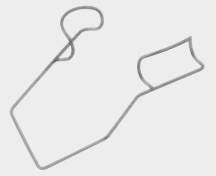

GRAEFE
62-0418
 11 cm, 4 $\frac{3}{8}$ "

Fixierpinzette, mit Sperre
 Fixation forceps, with ratchet
 Pinza de fijación, con cremallera
 Pince à fixation, avec crémaillère
 Pinza di fissaggio con cremagliera



HEIDELBERG
62-0505
 11 cm, 4 $\frac{3}{8}$ "

Fixierpinzette
 Fixation forceps
 Pinza de fijación
 Pince à fixation
 Pinza di fissaggio



BARRAQUER
62-0465
 10 cm, 3 $\frac{7}{8}$ "

Fixierpinzette, mit Sperre
 Fixation forceps, with ratchet
 Pinza de fijación, con cremallera
 Pince à fixation, avec crémaillère
 Pinza di fissaggio con cremagliera



BARRAQUER
62-0464
 11 cm, 4 $\frac{3}{8}$ "

Fixierpinzette
 Fixation forceps
 Pinza de fijación
 Pince à fixation
 Pinza di fissaggio



60-1229
 11 cm, 4 $\frac{3}{8}$ "

Fixierkralle, rechts
 Fixation claw, right
 Gancho para fijación, derecho
 Griffe à fixation, droite
 Uncino di fissaggio, destro



60-1230
 11 cm, 4 $\frac{3}{8}$ "

Fixierkralle, links
 Fixation claw, left
 Gancho para fijación, izquierdo
 Griffe à fixation, gauche
 Uncino di fissaggio, sinistro

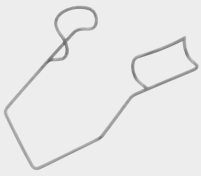

Bindehautpinzetten
 Conjunctiva Forceps
 Pinzas para conjuntiva
 Pincas conjonctivales
 Pinze per congiuntiva

Kolibripinzetten
 Colibri Forceps
 Pinzas tipo Colibrí
 Pincas Colibrí
 Pinze colibrí



KAUFMANN (GRAEFE)
62-0250
 7 cm, 2¾"

Bindehautpinzette mit Fadenplatte
 Conjunctiva forceps with tying platform
 Pinza para conjuntiva con plataforma
 Pince à disséquer avec plateau
 Pinza per la congiuntiva con piastra a filo



FÖRSTER
62-0201
 10 cm, 3⅞"

Bindehautpinzette
 Conjunctiva forceps
 Pinza para conjuntiva
 Pince à disséquer
 Pinza per congiuntiva



KREFELD (LESTER)
62-0520
 9,5 cm, 3¾"

Bindehautpinzette
 Conjunctiva forceps
 Pinza para conjuntiva
 Pince conjonctivales
 Pinza per congiuntiva



STEVENS
62-0165
 10,5 cm, 4⅛"

Bindehautpinzette
 Conjunctiva forceps
 Pinza para conjuntiva
 Pince conjonctivales
 Pinza per la congiuntiva



DRAEGER
62-0202
 10 cm, 3⅞"

Bindehautpinzette, atraumatisch
 Conjunctiva forceps, atraumatic
 Pinza para conjuntiva, atraumática
 Pince conjonctivales, atrauma
 Pinza per congiuntiva, atraumatica



62-0921
 7,5 cm, 3"

Mikro-Kolibripinzette, mit Fadenplatte, fein
 Micro-Colibri forceps, with tying platform, delicate
 Micro pinza tipo Colibrí, con plataforma, fina
 Micro-pince Colibrí, avec plateau, fins
 Micropinza colibrí con piastra portapunti, delicata

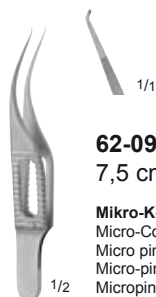

62-0922
 7,5 cm, 3"

Mikro-Kolibripinzette, mit Fadenplatte
 Micro-Colibri forceps, with tying platform
 Micro pinza tipo Colibrí, con plataforma
 Micro-pince Colibrí, avec plateau
 Micropinza colibrí con piastra portapunti



62-0362
 7,5 cm, 3"

Kolibripinzette, mit Fadenplatte
 Colibri forceps, with tying platform
 Pinza tipo Colibrí, con plataforma
 Pince Colibrí, avec plateau
 Pinza colibrí con piastra a filo



TROUTMAN
62-0907
 7,5 cm, 3"

Nahtpinzette, mit Fadenplatte
 Suturing forceps, with tying platform
 Pinza para ligaduras, con plataforma
 Pince à sutures, avec plateau
 Pinza per sutura, con piastra portapunti



ZÜRICH
62-0736
 7,5 cm, 3"

Nahtpinzette, fein
 Suturing forceps, delicate
 Pinza para ligaduras, delicada
 Pince à sutures, fine
 Pinza per sutura, delicata



ZÜRICH
62-0735
 7,5 cm, 3"

Nahtpinzette, abgewinkelt, fein
 Suturing forceps, angled, delicate
 Pinza para ligaduras, angulada, fina
 Pince à sutures, coudée, fine
 Pinza per sutura, angolata, delicata

Fragmentpinzetten
 Fragment Forceps
 Pinzas para fragmentos
 Pincés pour fragment
 Pinze per frammenti

Bandspreizpinzette
 Spreading Forceps
 Pinza para dilatar
 Pince pour écarter
 Pinza di diffusione

Nukleuspinzetten
 Nucleus Forceps
 Pinzas para núcleo
 Pincés pour nucléus
 Pinze per nucleo

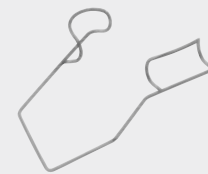

7,5 mm

KELMAN-MCPHERSON
62-0237
 10 cm, 3⁷/₈"

Fragmentpinzette, abgewinkelt
 Fragment forceps, angled
 Pinza para fragmento, angulada
 Pince pour fragment, coudée
 Pinza per frammenti angolata



9,0 mm

GASKIN
62-0239
 10 cm, 3⁷/₈"

Fragmentpinzette, abgewinkelt
 Fragment forceps, angled
 Pinza para fragmento, angulada
 Pince pour fragment, coudée
 Pinza per frammenti angolata

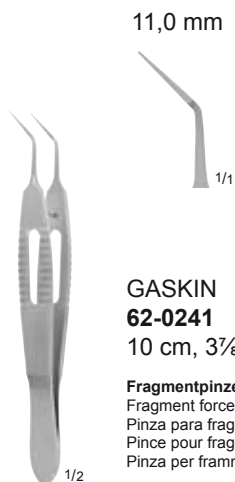

11,0 mm

GASKIN
62-0241
 10 cm, 3⁷/₈"

Fragmentpinzette, abgewinkelt
 Fragment forceps, angled
 Pinza para fragmento, angulada
 Pince pour fragment, coudée
 Pinza per frammenti angolata



WATZKE
62-1720
 11 cm, 4³/₈"

Bandspreizpinzette
 Spreading forceps
 Pinza para dilatar
 Pince pour écarter
 Forbice di diffusione



DARDENNE
62-1070
 11 cm, 4³/₈"

Nukleuspinzette
 Nucleus forceps
 Pinza para núcleo
 Pince pour nucléus
 Pinza per nucleo

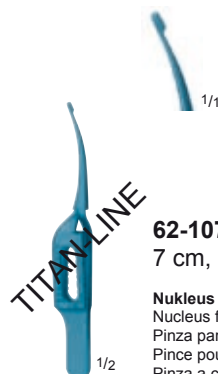

62-1075
 7 cm, 2³/₄"

Nukleus Pinzette zur Brechung des Linsenkerns
 Nucleus forceps for fracture a nucleus
 Pinza para fraccionar el núcleo del cristalino
 Pince pour diviser de nucléus
 Pinza a croce per nucleo, per l'incisione della lente

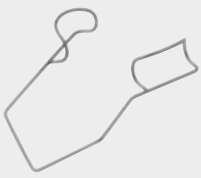

Fadenpinzetten

Suture Forceps

Pinzas para sutura

Pinces à suture

Pinze per sutura



TÜBINGEN
62-0810
10,5 cm, 4 1/8"

fein
delicate
delicada
fine
delicata

7,5 mm



62-0820
10 cm, 3 7/8"



TENNANT
62-0805
10 cm, 3 7/8"

extra fein
extremely delicate
muy delicada
très fine
delicatissima



TÜBINGEN
62-0832
10 cm, 3 7/8"



CASTROVIEJO
62-0848
10 cm, 3 7/8"

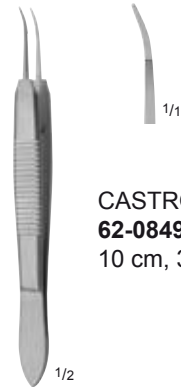

CASTROVIEJO
62-0849
10 cm, 3 7/8"



MC PHERSON
62-0853
10 cm, 3 7/8"

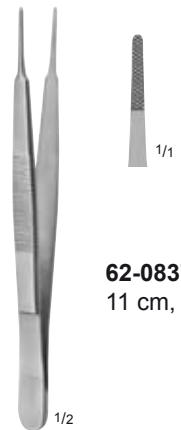

62-0837
11 cm, 4 3/8"



PAUFIQUE
62-0860
9 cm, 3 1/2"



PAUFIQUE
62-0808
8,5 cm, 3 3/8"

fein
delicate
delicada
fins
delicata

6,0 mm



DARDENNE
62-0823
10 cm, 3 7/8"



BARRAQUER
62-0940
7,5 cm, 3"

Fadenlöspinzette
Suture removing forceps
Pinza para retirar sutura
Pince pour enlever les fils
Pinza per la rimozione dei punti

Cilienpinzetten

Cilia Forceps

Pinzas para depilar

Pinces à cils

Pinze per ciglia

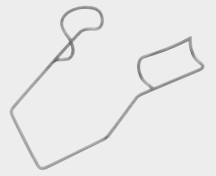

HENRY
62-1430
10,5 cm, 4 $\frac{1}{8}$ "



BARRAQUER
62-1435
11 cm, 4 $\frac{3}{8}$ "



BEER
62-1420
9 cm, 3 $\frac{1}{2}$ "



SAUPE
62-1445
10 cm, 3 $\frac{7}{8}$ "



GRADLE
62-1455
10 cm, 3 $\frac{7}{8}$ "



BARRAQUER
62-1460
10 cm, 3 $\frac{7}{8}$ "



SHAAF
62-1220
9,5 cm, 3 $\frac{3}{4}$ "

Cilien- und Fremdkörperpinzette
Cilia and foreign body forceps
Pinza para depilar y para cuerpos extraños
Pince à cils et à corps étrangers
Pinzetta per ciglie e corpi estranei



09-0968
10 cm, 3 $\frac{7}{8}$ "

Cilien- und Fremdkörperpinzette
Cilia and foreign body forceps
Pinza para depilar y para cuerpos extraños
Pince à cils pour corps étrangers
Pinza per ciglie e corpi estranei

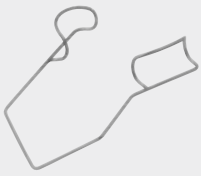

Nahtpinzetten
 Suture Forceps
 Pinzas para sutura
 Pinces à suture
 Pinze per sutura

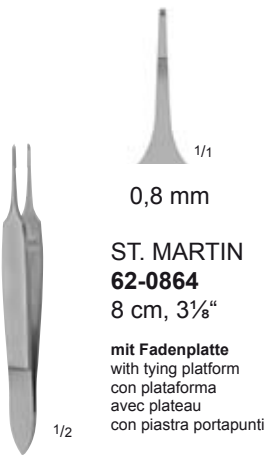

0,8 mm
ST. MARTIN
62-0864
 8 cm, 3 1/8"

mit Fadenplatte
 with tying platform
 con piattaforma
 avec plateau
 con piastra portapunti

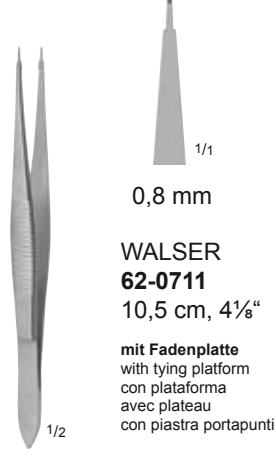

0,8 mm
WALSER
62-0711
 10,5 cm, 4 1/8"

mit Fadenplatte
 with tying platform
 con piattaforma
 avec plateau
 con piastra portapunti

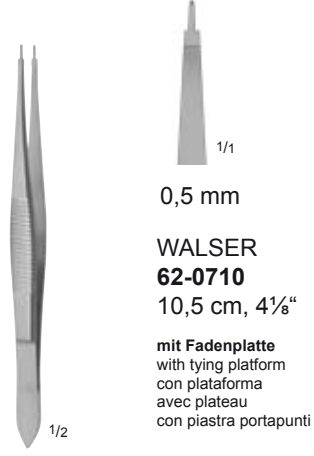

0,5 mm
WALSER
62-0710
 10,5 cm, 4 1/8"

mit Fadenplatte
 with tying platform
 con piattaforma
 avec plateau
 con piastra portapunti

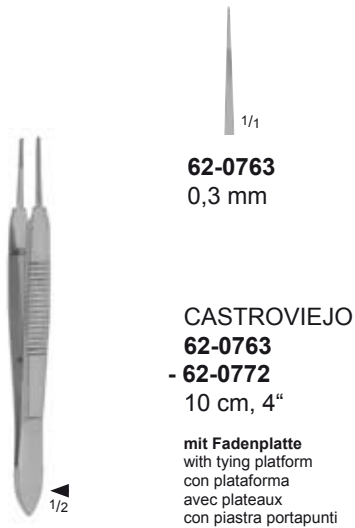

62-0763
 0,3 mm

62-0772
 0,5 mm

▶ **62-0771**
 0,9 mm

62-0770
 1,5 mm

CASTROVIEJO
62-0763
 - **62-0772**
 10 cm, 4"

mit Fadenplatte
 with tying platform
 con piattaforma
 avec plateaux
 con piastra portapunti

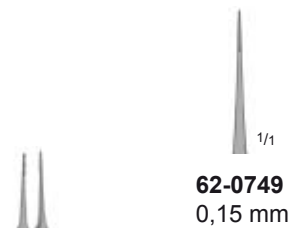

62-0749
 0,15 mm

▶ **62-0750**
 0,3 mm

62-0751
 0,5 mm

62-0752
 0,9 mm

CASTROVIEJO
62-0749
 - **62-0752**
 11 cm, 4 3/8"

mit Fadenplatte
 with tying platform
 con piattaforma
 avec plateaux
 con piastra portapunti

Zügelnahtpinzetten

Superior Rectus Forceps
Pinzas para recto superior
Pinces à fixer le droite supérieur
Pinze per retto superiore

Muskelpinzetten

Muscular Forceps
Pinzas musculares
Pinces-clamps musculaires
Pinze muscolari

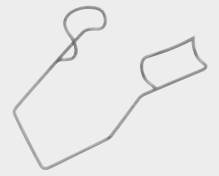

ELSCHNIG
62-0466
10,5 cm, 4 $\frac{1}{8}$ "

fein, 1x2 Zähne
delicate, 1x2 teeth
delicada, 1x2 dientes
fine, 1x2 dents
delicata, 1x2 denti



LEYDHECKER
62-0477
10,5 cm, 4 $\frac{1}{8}$ "

1x2 Zähne
1x2 teeth
1x2 dientes
1x2 dents
1x2 denti

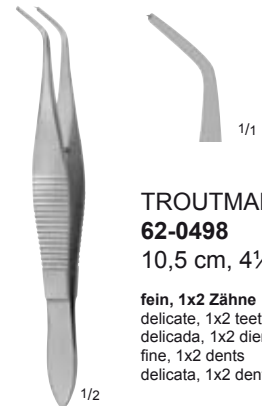

TROUTMAN
62-0498
10,5 cm, 4 $\frac{1}{8}$ "

fein, 1x2 Zähne
delicate, 1x2 teeth
delicada, 1x2 dientes
fine, 1x2 dents
delicata, 1x2 denti

Zügelnahtpinzetten • Superior rectus forceps • Pinzas para recto superior • Pince à fixer le droite supérieur • Pinze per retto superiore



ELSCHNIG
62-0470
11 cm, 4 $\frac{3}{8}$ "



REMKY
62-0467
10 cm, 3 $\frac{7}{8}$ "



CASTROVIEJO
62-0473
10 cm, 3 $\frac{7}{8}$ "

mit Fadenplatte
with tying platform
con plataforma
avec plateau
con piastra a filo

Zügelnahtpinzetten • Superior rectus forceps • Pinzas para recto superior • Pince à fixer le droite supérieur • Pinze per retto superiore



BANGERTER
62-3275
9,5 cm, 3 $\frac{3}{4}$ "

Muskelpinzette
Muscle forceps
Pinza muscular
Pince musculaire
Pinza muscolare



SATTLER
62-3256
10 cm, 3 $\frac{7}{8}$ "

Muskelpinzette, rechts
Muscle forceps, right
Pinza muscular, derecha
Pince musculaire, droite
Pinza muscolare, destra



SATTLER
62-3255
10 cm, 3 $\frac{7}{8}$ "

Muskelpinzette, links
Muscle forceps, left
Pinza muscular, izquierda
Pince musculaire, gauche
Pinza muscolare, sinistra

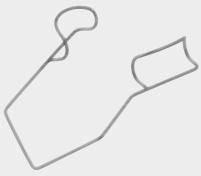

Lasik Hornhautflap Pinzetten

Lasik Flap Forceps
Pinzas corneales para lasik
Pincès à cornée pour lasik
Pinze corneale Lasik

Implantationspinzetten

Implantation Forceps
Pinzas para implantación
Pincès pour implantation
Pinze per trapianti



BURRATO
62-0212
10 cm, 3⁷/₈"

Lasik Hornhautflap Pinzette
Lasik flap forceps
Pinza corneal para lasik
Pince à cornée pour lasik
Pinza corneale Lasik



NUGENT
62-1030
10,5 cm, 4¹/₈"

Lasik Hornhautflap Pinzette
Lasik flap forceps
Pinza corneal para lasik
Pince à cornée pour lasik
Pinza corneale Lasik

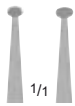

SHEPARD
62-1697
10 cm, 3⁷/₈"

mit Sperre
with ratchet
con cremallera
avec verrou
con chiusura



SHEPARD
62-1841
13 cm, 5¹/₈"

mit Sperre
with ratchet
con cremallera
avec verrou
con chiusura



DODAN
62-1692
10,5 cm, 4¹/₈"

Implantationspinzetten • Implantation forceps • Pinzas para implantación • Pincès pour implantation • Pinze per trapianti

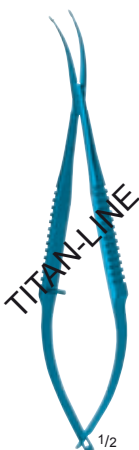

TITAN-LINE
KNOLLE-SHEPARD
62-1694
11,5 cm, 4¹/₂"

für HKL
for PCL
para PCL
pour PCL
por HKL



TITAN-LINE
TANNER
62-1699
11,5 cm, 4¹/₂"



NEUHANN
62-1696
7,5 cm, 3"



FECHNER
62-1693
8,5 cm, 3³/₈"

Implantationspinzetten • Implantation forceps • Pinzas para implantación • Pincès pour implantation • Pinze per trapianti

Faltpinzetten
 Folding Forceps
 Pinzas para plegar
 Pincers pour plier
 Pinze piega

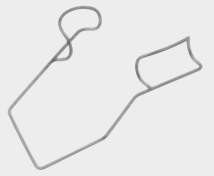

62-2065
 10 cm, 3⁷/₈"

Faltpinzette, für faltbare IOL's
 Folding forceps, for foldable IOL's
 Pinza para plegar IOL's plegables
 Pince pour saisir, pour IOLs pliabies
 Pinza piega IOL



62-2050
 10,5 cm, 4¹/₈"

Faltpinzette, für faltbare IOL's
 Folding forceps, for foldable IOL's
 Pinza para plegar IOL's plegables
 Pince pour plier, IOLs pliabies
 Pinza piega IOL



SPALECK
62-2051
 10,5 cm, 4¹/₈"

Faltpinzette, für faltbare IOL's
 Folding forceps, for foldable IOL's
 Pinza para plegar IOL's plegables
 Pince pour plier, pour IOLs pliabies
 Pinza piega IOL



KOCH
62-2060
 10 cm, 3⁷/₈"

Faltpinzette, für faltbare 3-stückige IOL's
 Folding forceps, for foldable 3-piece IOL's
 Pinza para plegar IOL's en 3 secciones
 Pince pour plier, pour IOLs pliabies en 3 pièces
 Pinza piega IOL a 3 strati



KOCH
62-2062
 10 cm, 3⁷/₈"

Faltpinzette, für Plate-Haptik IOL's
 Folding forceps, for plate haptic IOL's
 Pinza para plegar Plate-Haptik IOL's
 Pince pour plier pour plateau haptik IOLs
 Pinza piega Plate-Haptik IOL



62-2058
 10,5 cm, 4¹/₈"

Faltpinzette, mit Halteplatten, Acryl-IOL's
 Folding forceps, with notches for acrylic-IOL's
 Pinza para plegar, con soporte, acrilico-IOL's
 Pince pour plier avec des plateaux de fixation, IOLs acryl
 Pinza con piano di supporto, acrilico-IOL



NEUHANN
62-2057
 10 cm, 3⁷/₈"

Faltpinzette, für faltbare IOL's
 Folding forceps, for foldable IOL's
 Pinza para plegar IOL's
 Pince pour plier, pour IOLs pliabies
 Pinza piega IOL



BARRAQUER
62-0841
 10,5 cm, 4¹/₈"

Fasspinzette
 Grasping forceps
 Pinza de agarre
 Pince pour saisir
 Pinza da presa



CLAYMAN
62-1838
 13 cm, 5¹/₈"

Explantationspinzette, für IOL'S
 Explantation forceps, for IOL'S
 Pinza de explotación, para IOL's
 Pince à explantation, pour IOL's
 Pinza d'estrazione per IOL

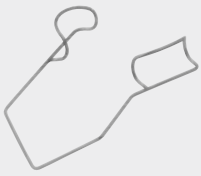

Irispinzetten
 Iris Forceps
 Pinzas para iris
 Pincès à iris
 Pinze per iride

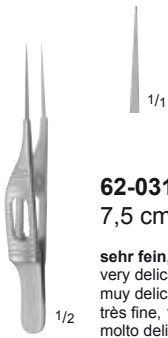

62-0310
 7,5 cm, 3"

sehr fein, 1x2 Zähne
 very delicate, 1x2 teeth
 muy delicada, 1x2 dientes
 très fine, 1x2 dents
 molto delicata, 1x2 denti

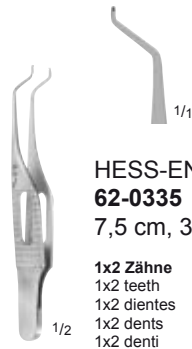

HESS-ENGELKING
62-0335
 7,5 cm, 3"

1x2 Zähne
 1x2 teeth
 1x2 dientes
 1x2 dents
 1x2 denti



BISHOP-HARMON
62-0231
 8,5 cm, 3³/₈"

1x2 Zähne
 1x2 teeth
 1x2 dientes
 1x2 dents
 1x2 denti



BISHOP-HARMON
62-0230
 8,5 cm, 3³/₈"

kräftig, 1x2 Zähne
 strong, 1x2 teeth
 robusta, 1x2 dientes
 molto, 1x2 dents
 robusta, 1x2 denti



BONN
62-0244
 7 cm, 2³/₄"

1x2 Zähne
 1x2 teeth
 1x2 dientes
 1x2 dents
 1x2 denti



6,0 mm
BONN
62-0246
 7 cm, 2³/₄"

1x2 Zähne
 1x2 teeth
 1x2 dientes
 1x2 dents
 1x2 denti



8,0 mm
BONN
62-0248
 7 cm, 2³/₄"

1x2 Zähne
 1x2 teeth
 1x2 dientes
 1x2 dents
 1x2 denti



SAUER
62-0561
 7,5 cm, 3"

leicht gebogen, 1x2 Zähne
 slightly curved, 1x2 teeth
 ligeramente curva, 1x2 dientes
 légèrement courbes, 1x2 dents
 curva, 1x2 denti



HEIDELBERG
62-0224
 8,5 cm, 3³/₈"

stark gebogen, 1x2 Zähne
 strongly curved, 1x2 teeth
 fuertemente curva, 1x2 dientes
 lames très courbes, 1x2 dents
 molto curva, 1x2 denti

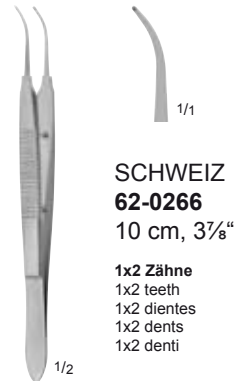

SCHWEIZ
62-0266
 10 cm, 3⁷/₈"

1x2 Zähne
 1x2 teeth
 1x2 dientes
 1x2 dents
 1x2 denti



HAMBURG
62-0296
 10 cm, 3⁷/₈"

1x2 Zähne
 1x2 teeth
 1x2 dientes
 1x2 dents
 1x2 denti

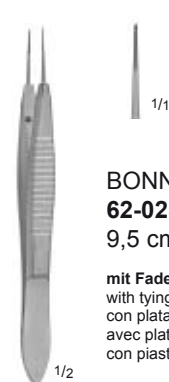

BONN
62-0256
 9,5 cm, 3³/₄"

mit Fadenplatte, 1x2 Zähne
 with tying platform, 1x2 teeth
 con plataforma, 1x2 dientes
 avec plateaux, 1x2 dents
 con piastra a filo, 1x2 denti



BONN
62-0258
 10 cm, 3⁷/₈"

1x2 Zähne
 1x2 teeth
 1x2 dientes
 1x2 dents
 1x2 denti

Irispinzetten, fein gerieft

Iris Forceps, fine serrated

Pinzas para iris, estriadas finas

Pinces à iris, striés fines

Pinze per iride, scanalatura delicata

Bulldogklemmen

Bulldog Clamps

Clamps Bulldog

Clamps Bulldog

Pinze Bulldog

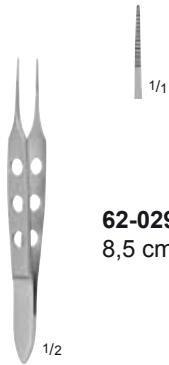
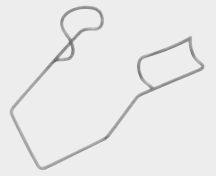

62-0291
8,5 cm, 3³/₈"

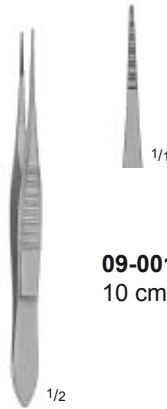

09-0016
10 cm, 3⁷/₈"

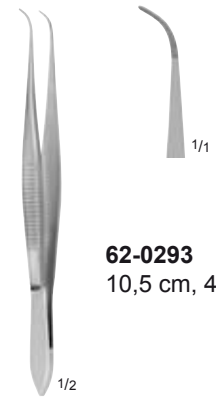

62-0293
10,5 cm, 4¹/₈"



6,0 mm
BONN 62-0245
7 cm, 2³/₄"



8,0 mm
BONN 62-0247
7 cm, 2³/₄"



9,0 mm
BONN 62-0243
7 cm, 2³/₄"

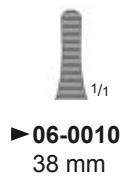

► **06-0010**
38 mm



06-0011
38 mm



DIEFFENBACH
06-0010
- **06-0011**

Bulldogklemmen
Bulldog Clamps
Clamps Bulldog
Clamps Bulldog
Pinze Bulldog



► **06-0022**
47 mm

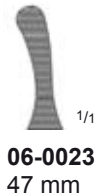

06-0023
47 mm



JOHNS-HOPKINS
06-0022
- **06-0023**

Bulldogklemmen
Bulldog Clamps
Clamps Bulldog
Clamps Bulldog
Pinze Bulldog

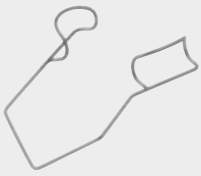

Arterienklemmen
 Haemostatic Forceps
 Pinzas hemostáticas
 Pincés hémostatiques
 Pinze emostatiche

Tuchklemmen
 Towel Clamps
 Pinzas de campo
 Pincés à compresses
 Pinze fissatelo

Fadenklemme
 Serrefine
 Pinza para ligadura
 Pince clamps á suture
 Clip vascolare

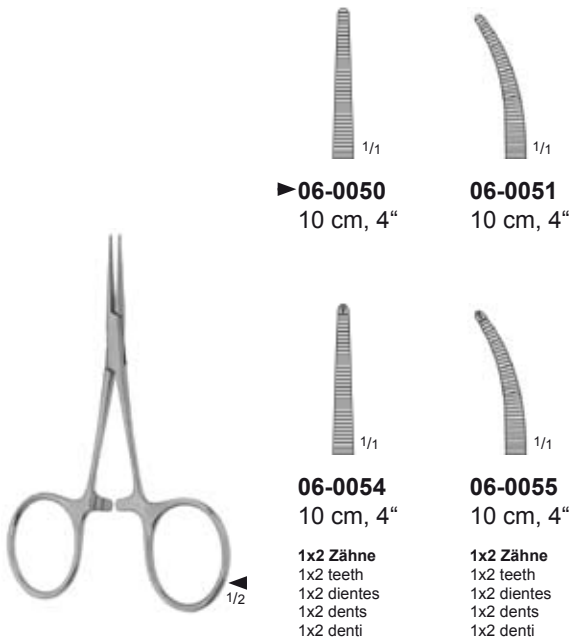

► **06-0050**
 10 cm, 4"

06-0051
 10 cm, 4"

06-0054
 10 cm, 4"

06-0055
 10 cm, 4"

1x2 Zähne
 1x2 teeth
 1x2 dientes
 1x2 dents
 1x2 denti

1x2 Zähne
 1x2 teeth
 1x2 dientes
 1x2 dents
 1x2 denti

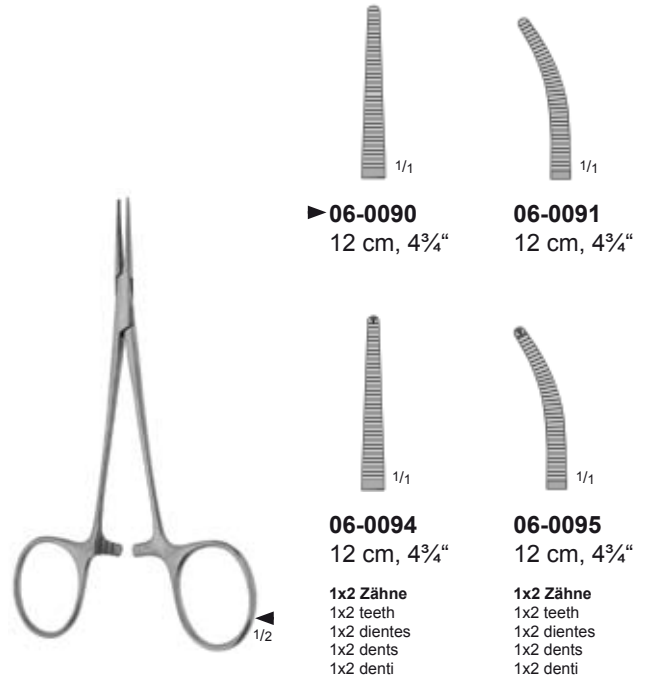

► **06-0090**
 12 cm, 4¾"

06-0091
 12 cm, 4¾"

06-0094
 12 cm, 4¾"

06-0095
 12 cm, 4¾"

1x2 Zähne
 1x2 teeth
 1x2 dientes
 1x2 dents
 1x2 denti

1x2 Zähne
 1x2 teeth
 1x2 dientes
 1x2 dents
 1x2 denti

HARTMANN
06-0050
- 06-0055

Arterienklemmen
 Haemostatic forceps
 Pinzas hemostáticas
 Pincés hémostatiques
 Pinze emostatiche

MICRO-HALSTED
06-0090
- 06-0095

Arterienklemmen
 Haemostatic forceps
 Pinzas hemostáticas
 Pincés hémostatiques
 Pinze emostatiche



BACKHAUS
07-0100
 9 cm, 3½"

Tuchklemme
 Towel clamp
 Pinza de campo
 Pince à compresses
 Pinza fissatelo



SCHÄDEL
07-0139
 9 cm, 3½"

Tuchklemme
 Towel clamp
 Pinza de campo
 Pince à compresses
 Pinza fissatelo



SCHWARTZ
50-0621
 3 cm, 1⅞"

Fadenklemme, besonders fein
 Serrefine, extremely delicate
 Pinza para ligadura, muy delicada
 Pince clamps á suture, très fine
 Clip vascolare delicato

Mikro-Nadelhalter mit flachen Federgriffen

Micro Needle Holders with flat spring type handles

Micro-Porta-agujas con mangos de resortes planos

Micro porte-aiguilles avec manches à ressorts plats

Micro portaghi con manici a molla piatta

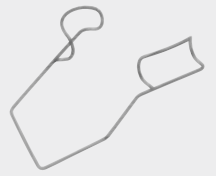

62-3742
9 cm, 3 1/2"



62-3743
9 cm, 3 1/2"

1/2

MICRO-CASTROVIEJO

62-3742

- **62-3743**

ohne Sperre
without catch
sin cremallera
sans verrou
senza cremagliera



▶ **62-3744**
9 cm, 3 1/2"



62-3745
9 cm, 3 1/2"

1/2

MICRO-CASTROVIEJO

62-3744

- **62-3745**

mit Sperre
with catch
con cremallera
à verrou
con cremagliera



▶ **62-3739**
13 cm, 5 1/8"



62-3736
13 cm, 5 1/8"



62-3735
13 cm, 5 1/8"

1/2

CASTROVIEJO

62-3735

- **62-3739**

ohne Sperre
without catch
sin cremallera
sans verrou
senza cremagliera



▶ **62-3740**
13 cm, 5 1/8"



62-3741
13 cm, 5 1/8"



62-3734
13 cm, 5 1/8"

1/2

CASTROVIEJO

62-3734

- **62-3741**

mit Sperre
with catch
con cremallera
à verrou
con cremagliera



Mikro-Nadelhalter mit runden Federgriffen

Micro Needle Holders with round spring type handles

Micro Porta-agujas con mangos de resortes redondos

Micro porte-aiguilles avec manches à ressorts ronds

Microportaghi con manici a molla rotonda



▶ **62-3706**
10,5 cm, 4 $\frac{1}{8}$ "

62-3707
10,5 cm, 4 $\frac{1}{8}$ "

BARRAQUER
62-3706
- **62-3707**

ohne Sperre
without catch
sin cremallera
sans verrou
senza cremagliera



▶ **62-3718**
10,5 cm, 4 $\frac{1}{8}$ "

62-3719
10,5 cm, 4 $\frac{1}{8}$ "

BARRAQUER
62-3718
- **62-3719**

mit Sperre
with catch
con cremallera
à verrou
con cremagliera



BARRAQUER
62-3732
11,5 cm, 4 $\frac{1}{2}$ "

ohne Sperre, sehr fein
without catch, very delicate
sin cremallera, muy delicada
sans verrou, très fins
senza cremagliera, molto delicata



BARRAQUER
62-3733
11,5 cm, 4 $\frac{1}{2}$ "

mit Sperre, sehr fein
with catch, very delicate
con cremallera, muy delicada
à verrou, très fins
con cremagliera, molto delicata



62-3768
11,5 cm, 4 $\frac{1}{2}$ "

62-3769
13,5 cm, 5 $\frac{1}{4}$ "

62-3755
11,5 cm, 4 $\frac{1}{2}$ "

▶ **62-3760**
13,5 cm, 5 $\frac{1}{4}$ "

BARRAQUER
62-3755
- **62-3769**

ohne Sperre
without catch
sin cremallera
sans verrou
senza cremagliera



62-3778
11,5 cm, 4 $\frac{1}{2}$ "

62-3779
13,5 cm, 5 $\frac{1}{4}$ "

62-3756
11,5 cm, 4 $\frac{1}{2}$ "

▶ **62-3761**
13,5 cm, 5 $\frac{1}{4}$ "

BARRAQUER
62-3756
- **62-3779**

mit Sperre
with catch
con cremallera
à verrou
con cremagliera

Mikro-Nadelhalter mit runden Federgriffen

Micro Needle Holders with round spring type handles

Micro Porta-agujas con mangos de resortes redondos

Micro porte-aiguilles avec manches à ressorts ronds

Microportaghi con manici a molla rotonda

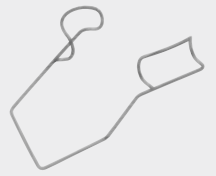

▶ **62-3765**
10 cm 4"

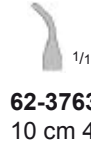

62-3763
10 cm 4"

BARRAQUER-TROUTMAN

62-3763

- **62-3765**

ohne Sperre
without catch
sin cremallera
sans verrou
senza cremagliera



▶ **62-3764**
10 cm 4"



62-3762
10 cm 4"

BARRAQUER-TROUTMAN

62-3762

- **62-3764**

mit Sperre
with catch
con cremallera
à verrou
con cremagliera



62-3873
11,5 cm 4¼"

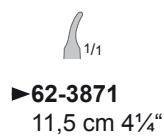

▶ **62-3871**
11,5 cm 4¼"

JACOBI

62-3871

- **62-3873**

ohne Sperre
without catch
sin cremallera
sans verrou
senza cremagliera



62-3872
11,5 cm 4¼"

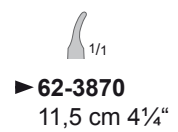

▶ **62-3870**
11,5 cm 4¼"

JACOBI

62-3870

- **62-3872**

mit Sperre
with catch
con cremallera
à verrou
con cremagliera

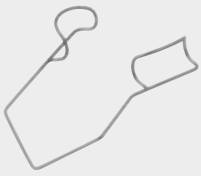

Mikro-Nadelhalter mit runden Federgriffen

Micro Needle Holders with round spring type handles

Micro Porta-agujas con mangos de resortes redondos

Micro porte-aiguilles avec manches à ressorts ronds

Microportaghi con manici a molla rotonda



BARRAQUER
(ORIGINAL MODEL)

62-3789

13 cm, 5 $\frac{1}{8}$ "

ohne Sperre
without catch
sin cremallera
sans verrou
senza cremagliera

1/2



BARRAQUER
62-3785

13,5 cm, 5 $\frac{3}{8}$ "

ohne Sperre, fein
without catch, delicate
sin cremallera, finas
sans verrou, fins
senza cremagliera, delicato

1/2



BARRAQUER
62-3786

13,5 cm, 5 $\frac{3}{8}$ "

mit Sperre, fein
with catch, delicate
con cremallera, finas
à verrou, fins
con cremagliera, delicato

1/2



BARRAQUER
62-3798

13 cm, 5 $\frac{1}{8}$ "

mit Sperre, kräftige Maulteile
with catch, heavy jaws
con cremallera, bocas robustas lisas
à verrou, mors forts
con cremagliera, morso robusto

1/2



BARRAQUER
62-3799

13 cm, 5 $\frac{1}{8}$ "

ohne Sperre, kräftige Maulteile
without catch, heavy jaws
sin cremallera, bocas robustas lisas
sans verrou, mors forts
senza cremagliera, morso robusto

1/2

Nadelhalter
Needle Holders
Porta-agujas
Porte-aiguilles
Portaghi

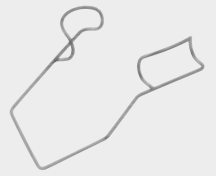

 1/1
► 08-0036
13,5 cm, 5¼"

 1/1
08-0035
13,5 cm, 5¼"

KALT
08-0035
- 08-0036

1/2



 1/1
► 62-3830
14 cm, 5½"

 1/1
62-3831
14 cm, 5½"

ARRUGA
62-3830
- 62-3831

1/2



 1/1
CASTROVIEJO
62-3752
13 cm, 5⅛"

ohne Sperre
without catch
sin cremallera
sans verrou
senza cremagliera

1/2



 1/1
CASTROVIEJO
62-3750
13 cm, 5⅛"

mit Sperre
with catch
con cremallera
à verrou
con cremagliera

1/2

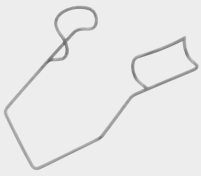

Nadelhalter
Needle Holders
Porta-agujas
Porte-aiguilles
Portaghi



ROHRSCHEIDER
62-3824
10 cm, 4"

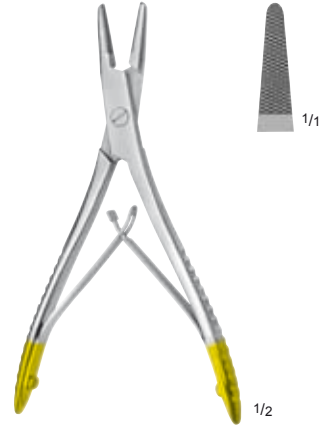

AXENFELD
62-3820
10,5 cm, 4 1/8"



BOYNTON
62-3845
12 cm, 4 3/4"

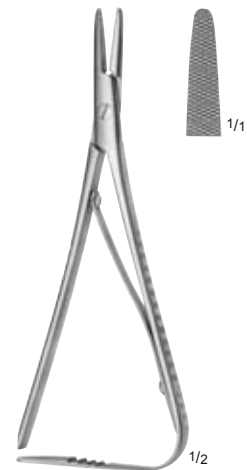

HEIDELBERG
62-3837
12 cm, 4 3/4"

Saugkeile

Absorbent Strips

Puntas absorbentes

Tampons absorbants

Tamponi triangolari

Halter für Saugkeile

Holder for Absorbent Strips

Porta para puntas absorbentes

Portes pour tampons

Manico per tamponi triangolari

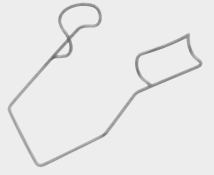

1/1

62-0390

Saugkeile, steril – Packung 20 Beutel à 10 Stück

Absorbent strips, sterile - Package 20 bags à 10 pieces

Puntas absorbentes, estériles - 20 bolsas de 10 unidades

Tampons absorbants, stériles - 20 sachets de 10 pièces

Tamponi triangolari sterili, confezione da 20 buste, 10 pezzi cad.



1/2

62-0380

18 cm, 7 1/8"

Halter für Saugkeile, gerieft

Holder for absorbent strips, serrated

Porta puntas absorbentes, estriado

Porte pour tampons, strié

Manico per tamponi triangolari



1/2

62-0382

18 cm, 7 1/8"

Halter für Saugkeile, mit Zähnen

Holder for absorbent strips, with teeth

Porta puntas absorbentes, con dientes

Porte pour tampons, avec dents

Manico per tamponi triangolari, dentellato

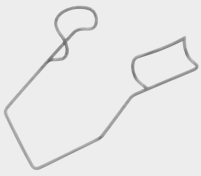

Klingen
Blades
Hojas
Lames
Lamette

Rasierklingenhalter und -brecher
Razor Blade Holders and Breakers
Pinzas para sujetar y romper hojas de afeitarse
Porte-lames et brise lames
Pinza afferra / spezza lamette

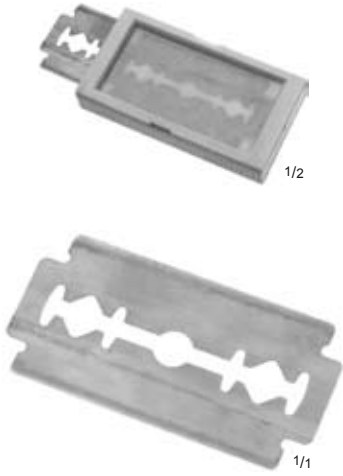

60-1780

Rasierklingen, brechbar, rostfrei, in Packungen zu 10 Stück

Razor blades, breakable, stainless steel, in packages of 10 pieces

Hojas de afeitarse, rompibles, de acero inoxidable, paquete de 10 piezas

Lames de rasoir, cassables, en inox, en paquets de 10 pièces

Lamette spezzabili acciaio inossidabile, confezione da 10 pezzi

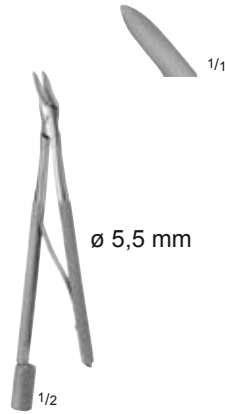

TROUTMAN

60-1794

9 cm, 3 1/2"

Rasierklingenhalter und -brecher

Razor blade holder and breaker
Pinza para sujetar y romper hojas de afeitarse
Porte-lames et brise lames
Pinza afferra / spezza lamette



TROUTMAN

60-1793

9,5 cm, 3 3/4"

Rasierklingenhalter und -brecher

Razor blade holder and breaker
Pinza para sujetar y romper hojas de afeitarse
Porte-lames et brise lames
Pinza afferra / spezza lamette



BARRAQUER

60-1795

11 cm, 4 3/8"

Rasierklingenhalter und -brecher

Razor blade holder and breaker
Pinza para sujetar y romper hojas de afeitarse
Porte-lames et brise lames
Pinza afferra / spezza lamette

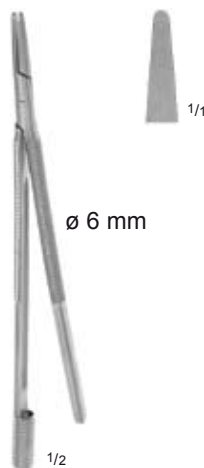

CASTROVIEJO

60-1797

12 cm, 5"

Rasierklingenhalter und -brecher

Razor blade holder and breaker
Pinza para sujetar y romper hojas de afeitarse
Porte-lames et brise lames
Pinza afferra / spezza lamette

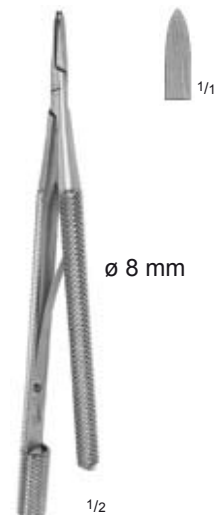

CASTROVIEJO

60-1791

13 cm, 5 1/8"

Rasierklingenhalter und -brecher

Razor blade holder and breaker
Pinza para sujetar y romper hojas de afeitarse
Porte-lames et brise lames
Pinza afferra / spezza lamette

Kapselpolier-Kanülen

Capsule Polishing Cannulae
Cánulas para pulir la cápsula
Canules pour polissage de la capsule
Capsula lucidatrice per cannula

Retrobulbäre Kanülen

Retrobulbar Cannulae
Cánulas retrobulbares
Canules rétrobulbaires
Cannula retrobulbare

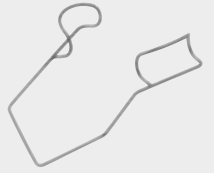

23G/0,61 mm



KRATZ
60-1490

18G/1,22 mm



62-2305

23G/0,61 mm



62-2229

Kapselpolier-Kanülen • Capsule polishing cannulae • Cánulas para pulir la cápsula • Canules pour polissage de la capsule • Canula per capsula lucidatrice

24G/0,56 x 40 mm



62-2235

25G/0,50 x 40mm



62-2236

24G/0,56 x 60mm



62-2345

25G/0,50 x 60mm



62-2237

Retrobulbäre Kanülen • Retrobulbar cannulae • Cánulas retrobulbares • Canules rétrobulbaires • Cannula retrobulbare

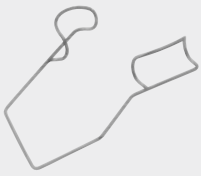

Verschiedene Augenkanülen

Various Eye Cannulae

Varias cánulas para ojos

Canules diverses oculaires

Varie cannule oculari varie

22G/0,71 mm



62-2227

Spülzystotomkanüle

Cystotome cannula
Cánula para irrigación de cistotomos
Canule d'irrigation de cystotome
Cistotomo irrigatore

19G/1,01 mm



62-2340

Saugkanüle

Aspiration cannula
Cánula de aspiración
Canule d'aspiration
Cannula d'aspirazione

24G/0,56 mm



63-2377

Enzymkanüle

Enzyme cannula
Cánula para enzima
Canule à enzyme
Cannula d'irrigazione

21G/0,81mm



60-1477

Healonkanüle

Healon cannula
Cánula para healon
Canule à healon?
Cannula per healon

23G/0,61 x 40 mm



**BANGERTER
63-2391**

23G/0,61 x 60 mm



**BANGERTER
63-2392**

21G/0,81 x 40 mm



**BANGERTER
63-2393**

21G/0,81 x 60 mm



**BANGERTER
62-2341**

Tränenwegsondenkanülen • Lacrimal probe cannulae • Cánulas para vías lacrimales • Canules à voies lacrymales • Sonda per canale lacrimale

Verschiedene Augenkanülen

Various Eye Cannulae

Varias cánulas para ojos

Canules diverses oculaires

Varie cannule oculari varie

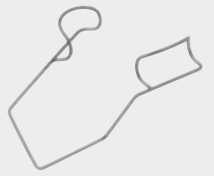

18G/1,22 mm



62-2304

Kapselpolierkanüle
Capsule polishing cannula
Cánulas para pulir la cápsula
Canule pour polissage de la capsule
Cannula per capsula lucidatrice

25G/0,5 mm



AMSLER
62-2250

Kapselpolierkanüle
Capsule polishing cannula
Pulidor para Cápsula
Canule pour polissage de la capsule
Cannula per capsula lucidatrice

23G/0,61 mm



62-2327

Tränenwegkanüle
Lacrimal cannula
Cánula para vias lacrimales
Canule à voies lacrymales
Sonde per canale lacrimale

23G/0,61 mm



62-2328

Tränenwegkanüle
Lacrimal cannula
Cánula para vias lacrimales
Canule à voies lacrymales
Sonde per canale lacrimale

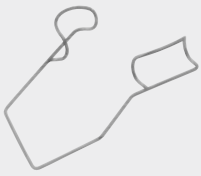

Tränenwegkanülen
Lacrimal Cannulas
Cánulas para vias lacrimales
Canules à voies lacrymales
Sonde per canale lacrimale

25G/0,5 mm



62-2311

konisch
conical
cónica
conique
conica

23G/0,61 mm



62-2312

konisch
conical
cónica
conique
conica

24G/0,56 mm



62-2313

konisch
conical
cónica
conique
conica

24G/0,56 mm



62-2314

konisch
conical
cónica
conique
conica

24G/0,56 mm



ANEL
62-2324

24G/0,56 mm



ANEL
62-2325

Luftkanülen, Hydrodissektion

Air Injection Cannulae, Hydrodissection

Cánulas para aire, hidrodisección

Canules à air, Hydrodissection

Cannule per idrodissezione



27G/0,4 mm



**SAUTTER
60-1518**

27G/0,4 mm



**FRANKFURT
62-2223**

30G/0,3 mm



**TÜBINGEN
60-1521**

30G/0,3 mm



62-2351

27G/0,4 mm



62-2350

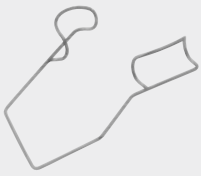

Spülkanülen
Irrigation Cannulae
Cánulas para irrigación
Canules irrigatoire
Cannule d'irrigazione

25G/0,5 mm



MÜLLER
62-2246

Spülkanüle, links
Irrigation cannula, left
Cánula para irrigación, izquierda
Canule irrigatoire, gauche
Cannula d'irrigazione, sinistra

25G/0,5 mm



MÜLLER
62-2247

Spülkanüle, rechts
Irrigation cannula, right
Cánula para irrigación, derecha
Canule irrigatoire, droite
Cannula d'irrigazione, destra



CRANZ
62-2217

Augenbrause, Silber
Eye douche, silver
Ducha para ojos, plata
Douche oculaire, argent
Doccia oculare in argento

20G/0,91 mm



62-2245

Spülschlingenkanüle
Irrigating vectis cannula
Cánula de asa para irrigación
Anse à lentilles avec irrigation
Cannula d'irrigazione per nucleo

23G/0,61 mm



62-2290

Spülschlingenkanüle
Irrigating vectis cannula
Cánula de asa para irrigación
Anse à lentilles avec irrigation
Cannula d'irrigazione per nucleo

Spülkanülen

Irrigation Cannulae

Cánulas para irrigación

Canules irrigatoire

Cannule d'irrigazione

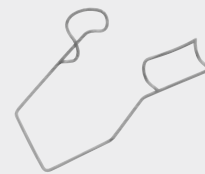

27G/0,4 mm



MCINTYRE
62-2309

Vorderkammerkanüle, abgewinkelt
Anterior chamber cannula, angled
Cánula para cámara anterior, angulada
Canule pour capsule antérieure, coudée
Cannula per capsula anteriore, angolata

20G/0,91 mm



BONN
62-2213

abgewinkelt, spatelförmig
angled, spatulated tip
angulada, en forma de espátula
coudée, en forme de spatule
angolata, a spatola

19G/1,01 mm



BONN
62-2215

abgewinkelt, spatelförmig
angled, spatulated tip
angulada, en forma de espátula
coudée, en forme de spatule
angolata, a spatola

26G/0,46 mm



BINKHORST
62-2206

abgewinkelt
angled
angulada
coudée
angolata

26G/0,46 mm



RENTSCH
62-2207

abgewinkelt
angled
angulada
coudée
angolata

21G/0,81 mm



BRAUWEILER
62-2242

abgewinkelt
angled
angulada
coudée
angolata

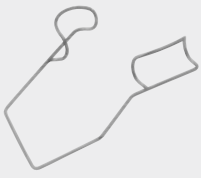

Saugkanülenhandgriffe

Aspiration Cannula Handpieces
Mangos para cánulas de aspiración
Manches pour canule d'aspiration
Manico per cannula d'aspirazione

Spül- und Saugkanülen

Irrigation and Aspiration Cannulae
Cánulas para irrigación y aspiración
Canules pour irrigation et aspiration
Cannule d'irrigazione ed aspirazione



BRAUWEILER
62-2280
9 cm, 3 1/2"



BRAUWEILER
62-2377
9 cm, 3 1/2"

Saugkanülenhandgriffe • Aspiration cannula handpieces • Mangos para cánulas de aspiración • Manches pour canule d'aspiration • Manico per cannula d'aspirazione

19G/1,01 mm



63-2310

fein
delicate
delicada
fins
delicata

21G/0,81 mm



H.-R.-KOCH
62-2378

aufgerauht
sandblasted
arenada
rugueux
sabbia

Absaugkanülen • Aspiration cannulae • Cánulas para aspiración • Canules d'aspiration • Cannula d'aspirazione

23G/0,61 mm



62-2232

25G/0,5 mm



SIMCOE
62-2240

Spül- und Saugkanülen • Irrigation and aspiration cannulae • Cánulas para irrigación y aspiración • Canules pour irrigation et aspiration • Cannule d'irrigazione ed aspirazione



BISHOP-HARMON
62-2550

Satz, bestehend aus: Silikonball, 20 ml, (62-2555), Adapter mit Luer Konus (62-2551), Kanüle (62-2552)
 Set, consisting of: silicone bulb, 20 ml, (62-2555), adapter with Luer-cone (62-2551), cannulae (62-2552)
 Caja, compuesta de: pera de silicona, 20 ml, (62-2555), adaptador con cono Luer (62-2551), cánula (62-2552)
 Set, composée de: balle en silicone, 20 ml, (62-2555), connecteur avec Luer cône (62-2551), canule (62-2552)
 Set composto da: contenitore in silicone da 20 ml, (62-2555), connettore con cono Luer (62-2551), cannula (62-2552)

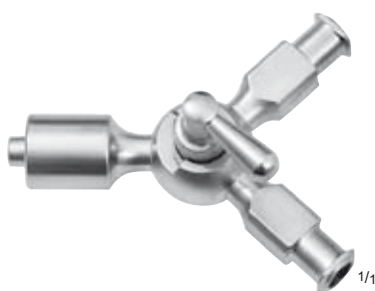

62-2590

Zweiwegehahn, 2xLuer-Lock weiblich, 1xLuer-Lock männlich
 Two-way-stopcock, 2xLuer-lock female, 1xLuer-lock male
 Llave de 2 vías, 2xLuer-Lock hembra, 1xLuer-Lock macho
 Robinet à 2 voies, 2xLuer-Locks femelles, 1xLuer-Lock mâle
 Rubinetto a 2 attacchi, 2xLuer-Lock femmina, 1xLuer-Lock maschio



07-2760

108 x 91 x 22 mm

Sterilisiergestell, für 5 Kanülen

Sterilizing rack, for 5 cannulae

Porta-cánulas para esterilización, de 5 cánulas

Porte-instruments pour stérilisation, pour 5 canules

Supporto per 5 cannule

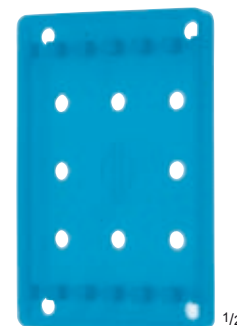

07-0920

85 x 55 x 18 mm

Sterilisiergestell, für 12 Kanülen

Sterilizing rack, for 12 cannulae

Porta-cánulas para esterilización, de 12 cánulas

Porte-instruments pour stérilisation, pour 12 canules

Supporto per 12 cannule

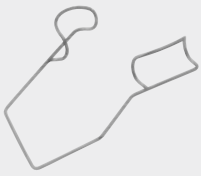

Trephinen

Trephines
Trépanos
Trépan
Tre quarti



1/1

BEST

- 63-1580** ø 1,0 mm
- 63-1581** ø 1,2 mm
- 63-1582** ø 1,3 mm
- 63-1583** ø 1,4 mm
- 63-1584** ø 1,5 mm
- 63-1585** ø 1,6 mm
- 63-1586** ø 1,7 mm
- 63-1587** ø 1,8 mm
- 63-1588** ø 1,9 mm
- 63-1589** ø 2,0 mm
- ▶ **63-1590** ø 2,5 mm

Trephinen
Trephines
Trépanos
Trépan
Tre quarti



1/1

ELLIOT

- 63-1540** ø 1,0 mm
- 63-1561** ø 1,1 mm
- 63-1562** ø 1,2 mm
- 63-1563** ø 1,3 mm
- 63-1564** ø 1,4 mm
- 63-1542** ø 1,5 mm
- 63-1566** ø 1,6 mm
- 63-1567** ø 1,7 mm
- 63-1544** ø 1,8 mm
- 63-1569** ø 1,9 mm
- 63-1546** ø 2,0 mm
- ▶ **63-1548** ø 2,5 mm

Trephinen
Trephines
Trépanos
Trépan
Tre quarti



1/1

SCHMIDT-MUMM

- 63-0090** ø 1,0 mm
- 63-0091** ø 1,1 mm
- 63-0092** ø 1,2 mm
- 63-0093** ø 1,3 mm
- 63-0094** ø 1,4 mm
- 63-0095** ø 1,5 mm
- ▶ **63-0096** ø 1,6 mm
- 63-0097** ø 1,7 mm
- 63-0098** ø 1,8 mm

Röhren-Trephinen
Duct-trephines
Trépanos
Trépan en tube
Tubo tre quarti



1/1

SCHWEIZER MODELL

- 63-1570** ø 1,0 mm
- 63-1572** ø 1,5 mm
- 63-1574** ø 1,8 mm
- 63-1576** ø 2,0 mm
- 63-1578** ø 2,5 mm
- 63-0080** ø 5,0 mm
- 63-0081** ø 6,0 mm
- ▶ **63-0082** ø 7,0 mm
- 63-0083** ø 9,0 mm
- 63-0084** ø 10,0 mm

Keratoplastiktrephinen
Keratoplasty trephines
Trépanos para queratoplastia
Trépan keratoplastie
Tre quarti cheratoplastica

Trephinen

Trephines

Trépanos

Trépan

Trequarti

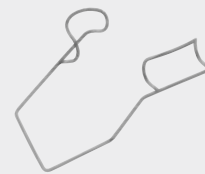

FRANCESCHETTI

- 63-0060 ø 5,0 mm
- 63-0061 ø 5,1 mm
- 63-0062 ø 6,0 mm
- ▶ 63-0063 ø 6,1 mm
- 63-0064 ø 7,0 mm
- 63-0065 ø 7,1 mm
- 63-0066 ø 8,0 mm
- 63-0067 ø 8,1 mm
- 63-0068 ø 9,0 mm
- 63-0069 ø 9,1 mm
- 63-0070 ø 10,0 mm

Keratoplastiktrephinen

Keratoplasty trephines
Trépanos para queratoplastia
Trépan keratoplastie
Trequarti cheratoplastica



BEST

- ▶ 63-0030 ø 5,0 mm
- 63-0031 ø 5,5 mm
- 63-0032 ø 6,0 mm
- 63-0033 ø 6,5 mm
- 63-0034 ø 7,0 mm
- 63-0035 ø 8,0 mm
- 63-0036 ø 9,0 mm
- 63-0037 ø 10,0 mm

Keratoplastiktrephinen

Keratoplasty trephines
Trépanos para queratoplastia
Trépan keratoplastie
Trequarti cheratoplastica



HAMBURG

- ▶ 63-0000 ø 5,0 mm
- 63-0001 ø 5,5 mm
- 63-0002 ø 6,0 mm
- 63-0003 ø 6,5 mm
- 63-0004 ø 7,0 mm
- 63-0005 ø 8,0 mm
- 63-0006 ø 9,0 mm
- 63-0007 ø 10,0 mm

Keratoplastiktrephinen

Keratoplasty trephines
Trépanos para queratoplastia
Trépan keratoplastie
Trequarti cheratoplastica



- 63-0040 ø 5,0 mm
- ▶ 63-0041 ø 5,5 mm
- 63-0042 ø 6,0 mm
- 63-0043 ø 6,5 mm
- 63-0044 ø 7,0 mm
- 63-0045 ø 8,0 mm
- 63-0046 ø 9,0 mm
- 63-0047 ø 10,0 mm

Mikro-Keratoplastiktrephinen

Micro keratoplasty trephines
Micro Trépanos para queratoplastia
Micro trépan keratoplastie
Trequarti micro cheratoplastica

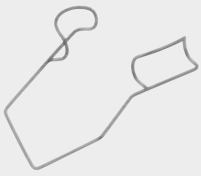

Tränenkanalsonden

Lachrymal Probes

Sondas para vías lacrimales

Sondes pour le canal lacrymal

Specilli per canale lacrimale

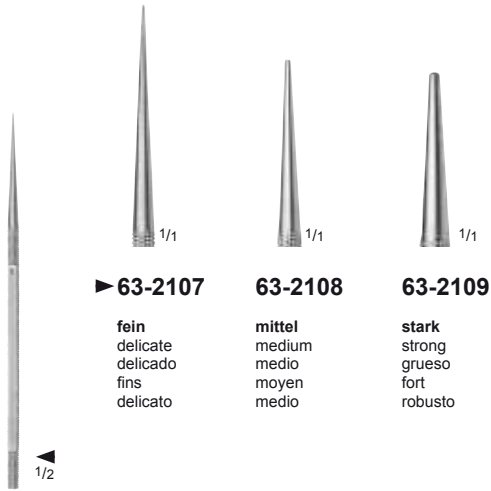

► 63-2107

fein
delicate
fins
delicato

63-2108

mittel
medium
medio
moyen
medio

63-2109

stark
strong
grueso
fort
robusto

1/2

WILDER
63-2107

- **63-2109**

10,5 cm, 4 1/8"

dünn
slim
delgado
fin
sottile

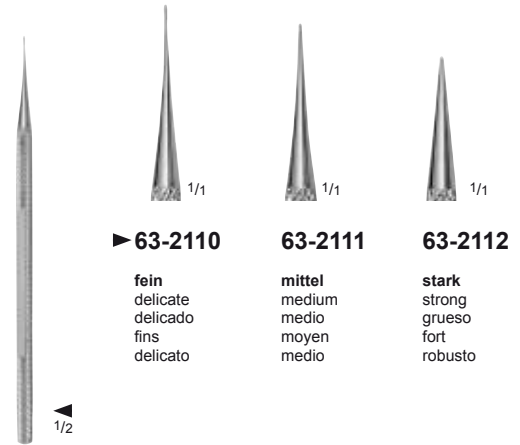

► 63-2110

fein
delicate
delicado
fins
delicato

63-2111

mittel
medium
medio
moyen
medio

63-2112

stark
strong
grueso
fort
robusto

1/2

WILDER
63-2110

- **63-2112**

10,5 cm, 4 1/8"



1/2

CASTROVIEJO

63-2120

14 cm, 3"



1/2

JÜNEMANN

► **63-2115** ø 0,6 mm

► **63-2116** ø 0,8 mm

63-2117 ø 1,0 mm

10 cm, 3 7/8"

mit Griffplatte
with handle
con mango
avec manche
con manico



1/2

GIESSEN

63-2105

7,5 cm, 3"

Tränenkanalsonden

Lachrymal Probes

Sondas para vías lacrimales

Sondes pour le canal lacrymal

Specilli per canale lacrimale

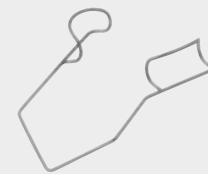

Fig.	ø mm	Silber Silver Plata Argent Argento	Neusilber German silver Plata meneses Argent blanc Argento bianco
0000/000	0,4 / 0,6	63-2200	63-2230
00/0	0,7 / 0,8	63-2201	63-2231
1/2	0,9 / 1,1	63-2202	63-2233
3/4	1,3 / 1,4	▶ 63-2203	63-2235
5/6	1,5 / 1,6	63-2204	63-2237
7/8	1,8 / 1,9	63-2205	63-2239

zylindrisch / zylindrisch
cylindrical / cylindrical
cilíndricas / cilíndricas
cylindriques / cylindriques
cilindrici / cilindrici

Fig.	ø mm	Silber Silver Plata Argent Argento	Neusilber German silver Plata meneses Argent blanc Argento bianco
0000/000	0,4 / 0,6	63-2225	63-2240
00/0	0,7 / 0,8	63-2220	63-2241
1/2	0,9 / 1,1	63-2221	63-2243
3/4	1,3 / 1,4	63-2222	63-2245
5/6	1,5 / 1,6	63-2223	63-2247
7/8	1,8 / 1,9	▶ 63-2224	63-2249

geknöpft / geknöpft
buttoned / buttoned
abotonadas / abotonadas
boutonnés / boutonnés
bottonuti / bottonuti

13 cm, 5 1/8"

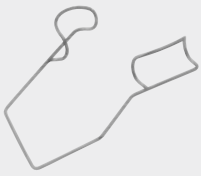

Sonden
 Probes
 Sondas
 Sondes
 Sonde



1/1

**HAMBURG
 60-1151**
 9,5 cm, 3³/₄"

**Retrogradsonde,
rechts**

Retrograde probe,
right

Sonda retrógrada,
derecha

Sonde rétrograde,
droite

Sonda retrograda,
destra



1/2

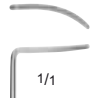

1/1

**HAMBURG
 60-1150**
 9,5 cm, 3³/₄"

**Retrogradsonde,
links**

Retrograde probe,
left

Sonda retrógrada,
izquierda

Sonde rétrograde,
gauche

Sonda retrograda,
sinistra



1/2



1/1

**KELLNAR
 60-1153**
 9 cm, 3¹/₂"

**Retrogradsonde,
rechts**

Retrograde probe,
right

Sonda retrógrada,
derecha

Sonde rétrograde,
droite

Sonda retrograda,
destra



1/2



1/1

**KELLNAR
 60-1152**
 9 cm, 3¹/₂"

**Retrogradsonde,
links**

Retrograde probe,
left

Sonda retrógrada,
izquierda

Sonde rétrograde,
gauche

Sonda retrograda,
sinistra



1/2



1/1

**MACKENSEN
 63-2308**
 9 cm, 3¹/₂"

**Trabekularsonde,
rechts**

Trabeculotomy probe,
right

Sonda trabecular,
derecha

Sonde à trabeculotomie,
droite

Sonda per trabeculo,
destra



1/2



1/1

**MACKENSEN
 63-2307**
 9 cm, 3¹/₂"

**Trabekularsonde,
links**

Trabeculotomy probe,
left

Sonda trabecular,
izquierda

Sonde à trabeculotomie,
gauche

Sonda per trabeculo,
sinistra



1/2

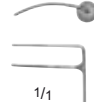

1/1

**HARMS
 63-2306**
 9,5 cm, 3³/₄"

**Trabekularsonde,
rechts**

Trabeculotomy probe,
right

Sonda trabecular,
derecha

Sonde à trabeculotomie,
droite

Sonda per trabeculo,
destra



1/2

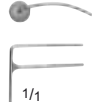

1/1

**HARMS
 63-2305**
 9,5 cm, 3³/₄"

**Trabekularsonde,
links**

Trabeculotomy probe,
left

Sonda trabecular,
izquierda

Sonde à trabeculotomie,
gauche

Sonda per trabeculo,
sinistra



1/2

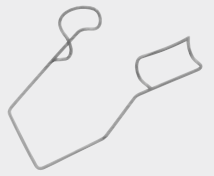

WADDSWORTH-TODD
60-1445
14,5 cm, 5³/₄"

Kauter
Cautery
Cauterio
Cautère
Cauterio



WILLS-HOSPITAL
60-1450
13,5 cm, 5³/₈"

Kauter
Cautery
Cauterio
Cautère
Cauterio

60-1455



60-1452

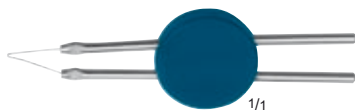

60-1453

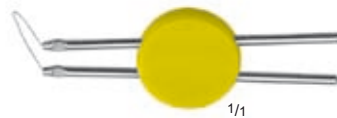

60-1451

Augenkauter, komplett, bestehend aus:

- 60-1452** Ersatzbrenner, allein
- 60-1453** Ersatzbrenner, allein
- 60-1454** Batterien, allein
- 60-1455** Handgriff, allein

Cautery, complete, consisting of:

- 60-1452 Spare cautery, only
- 60-1453 Spare cautery, only
- 60-1454 Batteries, only
- 60-1455 Handle, only

Cauterio, completo, compuesto de:

- 60-1452 Cauterio de repuesto, suelto
- 60-1453 Cauterio de repuesto, suelto
- 60-1454 Baterias, sueltas
- 60-1455 Mango, suelto

Cautère, complet, composé de:

- 60-1452 Cautère de rechange, seul
- 60-1453 Cautère de rechange, seul
- 60-1454 Pile, seul
- 60-1455 Manche, seul

Cauterio completo, composto da:

- 60-1452 cannello di ricambio
- 60-1453 cannello di ricambio
- 60-1454 batterie
- 60-1455 manico

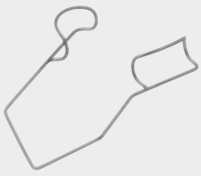

Markierungsinstrumente

Markers
Marcadores
Marqueurs
Marcatori

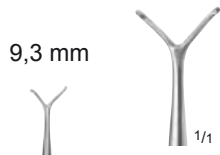

9,3 mm

1/1

FINK

60-1340

8 cm, 3 1/8"

Markierungsinstrument

Marker
Marcador
Marqueur
Marcatore

1/2

5 x 5 mm



1/1

FRONIMOPOULUS

60-1343

7 cm, 2 3/4"

Markierungsinstrument

Marker
Marcador
Marqueur
Marcatore

1/2

ø 0,2 mm



1/1

SINSKEY

60-1347

10,5 cm, 4 1/8"

Markierhäkchen, runde Spitze

Marking hook, round tip
Gancho marcador, punta redonda
Crochet à marqueur bout rond
Uncino marcatore, punta rotonda

1/2



1/1

NEUHANN

60-0908

10,5 cm, 4 1/8"

Nahtmarkierer

Suture marker
Marcador para sutura
Marqueur pour suture
Marcatore per sutura

1/2



1/2



1/1

60-0966

6 Klinden
6 blades
6 cuchillas
6 coupes
6 lame

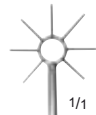

1/1

▶ **60-0967**

8 Klinden
8 blades
8 cuchillas
8 coupes
8 lame

Innendurchmesser 3,0 mm, Außendurchmesser 12 mm

Inside diameter 3.0 mm, outside diameter 12 mm
Diámetro interior 3,0 mm, diámetro exterior 12 mm
Diamètre intérieur 3,0 mm, diamètre extérieur 12 mm
Diametro interno 3,0 mm, diametro esterno 12 mm

NEUHANN

60-0966

- **60-0967**

10,5 cm, 4 1/8"

Hornhautmarkierer

Corneal markers
Marcadores de córnea
Marqueurs pour kératoplastie
Marcatori corneale



1/2

HOFFER

60-0970

- **60-0981**

10,5 cm, 4 1/8"

Hornhautmarkierer, für optisches Zentrum

Corneal markers, for optic zone
Marcadores de córnea para centro óptico
Marqueurs pour kératoplastie pour centre optique
Marcatori corneale, centro oculare

Innendurchmesser:

Inside diameter:
Diámetro interior:
Diamètre intérieur:
Diametro interno:

60-0970 3,00 mm

60-0971 3,25 mm

60-0972 3,50 mm

60-0973 3,75 mm

60-0974 4,00 mm

60-0975 4,50 mm

60-0976 5,00 mm

60-0977 5,50 mm

60-0978 6,00 mm

60-0979 6,50 mm

▶ **60-0980** 7,00 mm

60-0981 7,50 mm

Markierungsinstrumente

Markers
Marcadores
Marqueurs
Marcatori

Augenklappen

Eye Shields
Protectores para ojos
Protecteurs des yeux
Protettori oculari

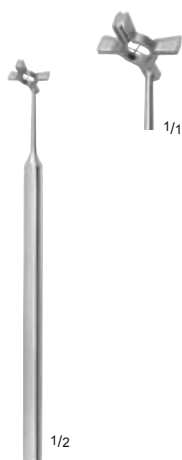
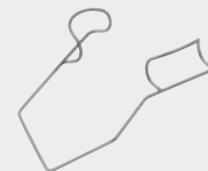

MENDEZ
60-0914
10,5 cm, 4 1/8"

Hornhautmarkierer Lasik
Corneal marker for Lasik
Marcador para córnea lasik
Marqueur pour kératoplastie Lasik
Marcatore corneale, tecnica lasik

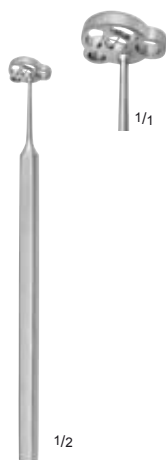

CHAYET
60-0910
10,5 cm, 4 1/8"

Hornhautmarkierer Lasik
Corneal marker for Lasik
Marcador para córnea lasik
Marqueur pour kératoplastie Lasik
Marcatore corneale, tecnica lasik



ANIS
60-0920
11,5 cm, 4 1/2"

Nahtplatzierungsmarkierer
Suture placement marker
Marcador para la colocación de suturas
Marquer à suture
Marcatore per sutura

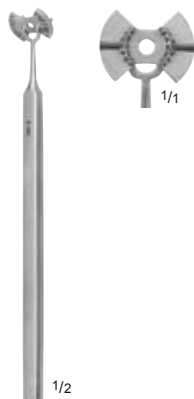

LINDSTROM
60-0990
10,5 cm, 4 1/8"

Hornhautmarkierer, für optische Zone
Corneal marker, for optic zone
Marcador de córnea para centro óptico
Marqueur pour kératoplastie pour centre optique
Marcatore corneale, centro oculare



LINDSTROM
60-0991
12 cm, 4 3/4"

Hornhautmarkierer, für optische Zone
Corneal marker, for optic zone
Marcador de córnea para centro óptico
Marqueur pour kératoplastie pour centre optique
Marcatore corneale, centro oculare



SUPRAMID
63-2854

Augenklappe, rechtes Auge
Eye shield, right eye
Protector para ojo, derecho
Protecteur, pour l'oeil droit
Protettore oculare, occhio destro



SUPRAMID
63-2855

Augenklappe, linkes Auge
Eye shield, left eye
Protector para ojo, izquierdo
Protecteur, pour l'oeil gauche
Protettore oculare, occhio sinistro

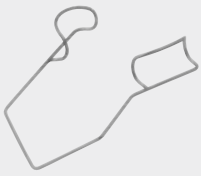

Stanzen

Punches

Pinzas saca-bocados

Poinçonneuses

Pinze

1,5 x 0,6 mm



1/2

GASS
60-2250

8,5 cm, 3 $\frac{3}{8}$ "

Glaukomstanze
Glaucoma punch
Pinza saca-bocado para glaucoma
Poinçonneuses pour glaucome
Pinza per glaucoma

ø 1 mm



1/2

KELLY
60-2254

13,5 cm, 5 $\frac{3}{8}$ "

Descemet's Membranstanze
Descemet's membrane punch
Pinza saca-bocado para membrana Descemet's
Descemet's poinçonneuses pour membrane
Pinza per membrana Descemet

1,0 x 0,5 mm



1/2

LUNTZ-DODICK
60-2256

11,5 cm, 4 $\frac{1}{2}$ "

Glaukomstanze
Glaucoma punch
Pinza saca-bocado para glaucoma
Poinçonneuses pour glaucome
Pinza per glaucoma

2 x 1 mm



1/2

WALSER
63-2730

9,5 cm, 3 $\frac{3}{4}$ "

Sklerastanze
Corneoscleral punch
Pinza saca-bocado escleral
Poinçonneuses pour sclérale
Punzone per sclera

Knochenstanzen

Bone Punches

Pinzas para cortar huesos

Pinces emporte-pièces

Pinze per laminectomia

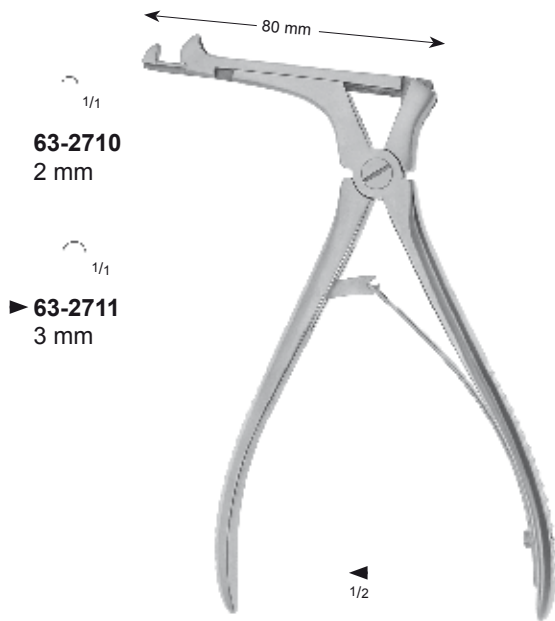
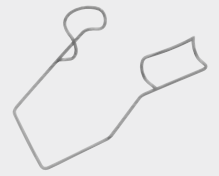

63-2710
2 mm

▶ 63-2711
3 mm

CITELLI
63-2710
- 63-2711

nach oben schneidend 90°
upwards cutting 90°
cortante hacia arriba 90°
coupant vers le haut 90°
taglio a 90° verso l'alto

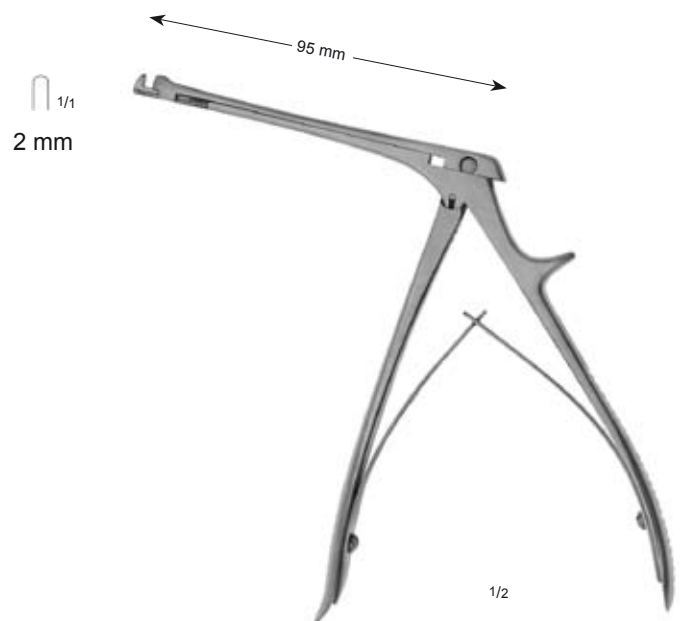

2 mm

BEYER
63-2720

nach oben schneidend 90°
upwards cutting 90°
cortante hacia arriba 90°
coupant vers le haut 90°
taglio a 90° verso l'alto

45-0790
3 mm

▶ 45-0791
4 mm

45-0792
5 mm



KERRISON
45-0790
- 45-0792

nach oben schneidend 90°
upwards cutting 90°
cortante hacia arriba 90°
coupant vers le haut 90°
taglio a 90° verso l'alto

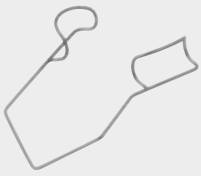

Messinstrumente
 Measuring Instruments
 Instrumentos de medición
 Instruments pour mesurer
 Strumenti per misurare

Messbereich: 15 mm
 Measuring range: 15 mm
 Rango de medición: 15 mm
 Calibre: 15 mm
 Calibro: 15 mm



CASTROVIEJO
63-1800
 8 cm, 3 1/8"

Zirkel
 Caliper
 Compás
 Compas
 Compasso

Messbereich: 20 mm
 Measuring range: 20 mm
 Rango de medición: 20 mm
 Calibre: 20 mm
 Calibro: 20 mm



CASTROVIEJO
63-1801
 8 cm, 3 1/8"

Zirkel
 Caliper
 Compás
 Compas
 Compasso

Messbereich: 10 mm
 Measuring range: 10 mm
 Rango de medición: 10 mm
 Calibre: 10 mm
 Calibro: 10 mm



OSHER
63-1880
 8 cm, 3 1/8"

Inzisions-Messzirkel
 Incision measuring caliper
 Compás para incisión
 Compas Incision
 Compasso incisore



SCHIOETZ
63-2405
 10,5 cm, 4 1/8"

Tonometer
 Tonometer
 Tonómetro
 Tonomètre
 Tonometro

Messbereich: 30 mm
 Measuring range: 30 mm
 Campo de medición: 30 mm
 Calibre: 30 mm
 Calibro: 30 mm



ENGELS
60-1765
 8,5 cm, 3 3/8"

Messspatel
 Measuring spatula
 Espátula de medición
 Spatule à mesurer
 Spatola graduata

Messbereich: 0° - 180°
 Measuring range: 0° - 180°
 Campo de medición: 0° - 180°
 Calibre: 0° - 180°
 Calibro: 0° - 180°



MENDEZ
60-1770
 11 cm, 4 3/8"

Grad Messinstrument
 Degree gauge
 Calibrador de ángulos
 Instrument pour mesurer les degrés
 Strumento di misurazione graduato



18-0161 15 cm, 6"
18-0164 20 cm, 8"
▶ 18-0162 30 cm, 12"

Stahl-Maßstäbe, mit Millimeter-Einteilung
 Steel rules, graduated in millimeters
 Reglas graduadas en milímetros
 Règle en acier, graduée en millimètres
 Righe graduate in acciaio, millimetri

Sterilisierbehälter

Sterilizing Boxes

Cajas de esterilización

Boîtes pour stérilisation

Cestelli per sterilizzazione

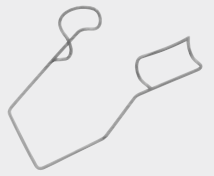

► 07-0709

295 x 215 x 50 mm

(außen, outside, exterior, extérieur, esterne)

280 x 195 x 42 mm

(innen, inside, interior, intérieur, interne)

07-0719

400 x 280 x 50 mm

(außen, outside, exterior, extérieur, esterne)

380 x 260 x 42 mm

(innen, inside, interior, intérieur, interne)

Sterilisierbehälter mit Deckel- und Bodenlochung und Textil-Langzeitfilter für Dampfsterilisation. Herausnehmbare Siebplatte mit Silikonstreifen dient zur schonenden Lagerung von Instrumenten.

Sterilizing boxes, lid and bottom perforation, with long-term textile filter for steam sterilization. Removable perforated tray with silicone cushions used to store instruments carefully.

Cajas de esterilización con tapa y fondo perforado y filtro de tejido de larga duración para la esterilización al vapor. Bandeja retirable con soportes de silicona, que sirven para el almacenaje cuidadoso.

Boîtes pour stérilisation avec fond et couvercle perforés et filtre tissu longue durée pour stérilisation à vapeur. Plateau perforé amovible avec tapis en silicone permettant de ranger soigneusement les instruments.

Cestelli per sterilizzazione con coperchio a fondo perforato, filtro tessile a lunga durata per sterilizzazione a vapore. Inserti estraibili con supporto in silicone che permettono una corretta collocazione degli strumenti.



► 07-2709

295 x 215 x 70 mm

(außen, outside, exterior, extérieur, esterne)

280 x 195 x 55 mm

(innen, inside, interior, intérieur, interne)

07-2719

400 x 280 x 70 mm

(außen, outside, exterior, extérieur, esterne)

380 x 260 x 55 mm

(innen, inside, interior, intérieur, interne)

Sterilisierbehälter mit Deckel- und Bodenlochung und Textil-Langzeitfilter für Dampfsterilisation. 2 herausnehmbare Siebplatten mit Silikonstreifen dient zur schonenden Lagerung von Instrumenten.

Sterilizing boxes, lid and bottom perforation, with long-term textile filter for steam sterilization. 2 removable perforated trays with silicone cushions used to store instruments carefully.

Cajas de esterilización con tapa y fondo perforado y filtro de tejido de larga duración para la esterilización al vapor. 2 bandejas retirables con soportes de silicona, que sirven para el almacenaje cuidadoso.

Boîtes pour stérilisation avec fond et couvercle perforés et filtre tissu longue durée pour stérilisation à vapeur. 2 Plateaux perforés amovibles avec tapis en silicone permettant de ranger soigneusement les instruments.

Cestelli per sterilizzazione con coperchio a fondo perforato, filtro tessile a lunga durata per sterilizzazione a vapore. 2 Inserti estraibili con supporto in silicone che permettono una corretta collocazione degli strumenti.

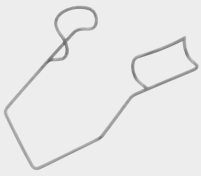

Verschiedenes
 Miscellaneous
 Diversos artículos
 Articles divers
 Articoli vari



MEAD
47-0115
 19 cm, 7½"

Hammer mit auswechselbaren Kunststoffbacken (47-0195)

Mallet with interchangeable plastic disks (47-0195)

Martillo con tapas de plástico intercambiables (47-0195)

Maillet avec masse plastique interchangeable (47-0195)

Martello con piastre di plastica intercambiabili (47-0195)

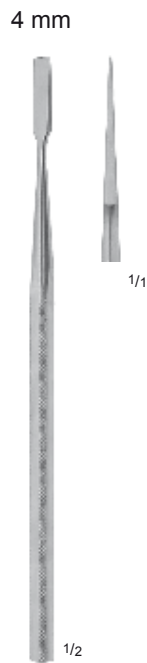

WEST
63-2900
 16 cm, 6¼"

Flachmeißel
 Chisel
 Cíncel
 Ciseaux-burin
 Scalpello



WEST
63-2905
 16 cm, 6¼"

Hohlmeißel
 Gouge
 Gubia
 Gouge
 Sgorbia



LEMPERT
68-1214
 17 cm, 6¾"

Raspatorium
 Raspatory
 Periostotomo
 Rugines-raspatoire
 Periostotomo



SEBILEAU
48-0118
 17 cm, 6¾"

Elevatorium
 Elevator
 Elevador
 Élévateur
 Elevatore

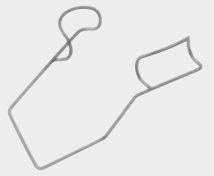

1/1



**HEIMANN
 60-2225**

**Skleranagel, in
 Packungen zu 6 Stück**

Sclera pin, in packages
 of 6 pieces

Pin para esclera, en
 paquetes de 6 piezas

Clou pour la sclère, en
 paquets de 6 pièces

Ago per sclera, in
 confezioni di 6 pezzi

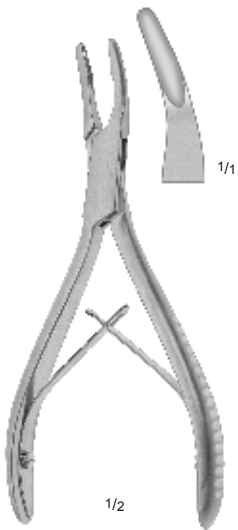

1/1

1/2

**LUER-FRIEDMAN
 45-0628**
 13 cm, 5 1/4"

Hohlmeißelzangen
 Bone rongeurs
 Pinza-gubia
 Pince-gouge
 Pinza per ossa



1/2

**HARTMANN
 70-0130**
 16 cm, 6 1/4"

Nasenspekula
 Nasal specula
 Espéculo nasal
 Spéculum pour nez
 Speculo nasale



1/2

60-0821
Drahtschlinge
 Wire loop
 Asa
 Anse
 Ansa

**H.-R.-KOCH
 60-0820**
 13,5 cm, 5 3/8"

**zum Teilen implantierter
 Silikon IOL's**

for dividing implanted
 silicone IOL's

para división de implante de
 silicona IOL's

pour diviser implanté silicone
 IOL's

per separare impiantati in silicone
 IOL



1/2

**CARTER
 60-2220**
 12,5 cm, 4 7/8"

**Einführer und Halter für
 Enukleationsplomben**

Insertor and support for
 enucleation seals

Introducor y sujetador para
 precintos de enucleación

Introduceur et support pour
 plombs d'enucléation

Guida per piombo
 enucleatore



1/2

60-2224
 12,5 cm, 4 7/8"

Einführer für Skleranagel

Insertor for sclera pins

Introducor del pin para
 esclera

Introduceur pour le clou
 pour la sclère

Guida per ago per sclera



Notizen

Notes

Notas

Notes

Note



LAWTON

MEDIZINTECHNIK



Empfohlene Instrumenten Sätze
Suggested Instrument Sets
Cajas de instrumentos sugeridos
Des sets d'instrumentation proposés
Set di strumentario consigliati

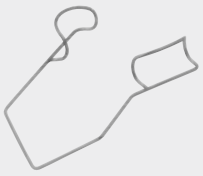

Astigmatische Keratotomie

Astigmatic Keratotomy

Queratotomía astigmática

Kératotomie astigmatisme

Cheratomia astigmatismo



1.



2.



3.



4.



5.



6.



7.



8.



9.



10.

	Article No.	Description	Qty.	Page
1.	60-0125	Barraquer Phaco Eye Speculum	1	2
2.	60-0802	Swivel Fixation Ring ø16mm, 12 cm	1	12
3.	60-0607	Diamond Knife Micrometer Arcuate Balde 15° 0.2-1.0mm	1	14
4.	62-0362	Colibri Forceps 7.5 cm with tying platform	1	54
5.	62-1696	Neuhann Implantation Forceps, 7.5 cm	1	56
6.	60-1518	Sautter Air Injection Cannula 27G curved	2	77
7.	60-0980	Hoffer Corneal Marker for optic zone 7.0 mm, 10.5 cm	1	88
8.	60-0990	Lindstrom Corneal Marker for optic zone, 10.5 cm	1	89
9.	60-0991	Lindstrom Corneal Marker for optical zone, 10.5 cm	1	89
10.	60-1770	Mendez Degree Gauge C 10° from 0 - 180°	1	92

Katarakt Extrakapsular
 Cataract Extra Capsular
 Catarata -Extracapsular-
 Cataracte Extracapsulaire
 Cataratta

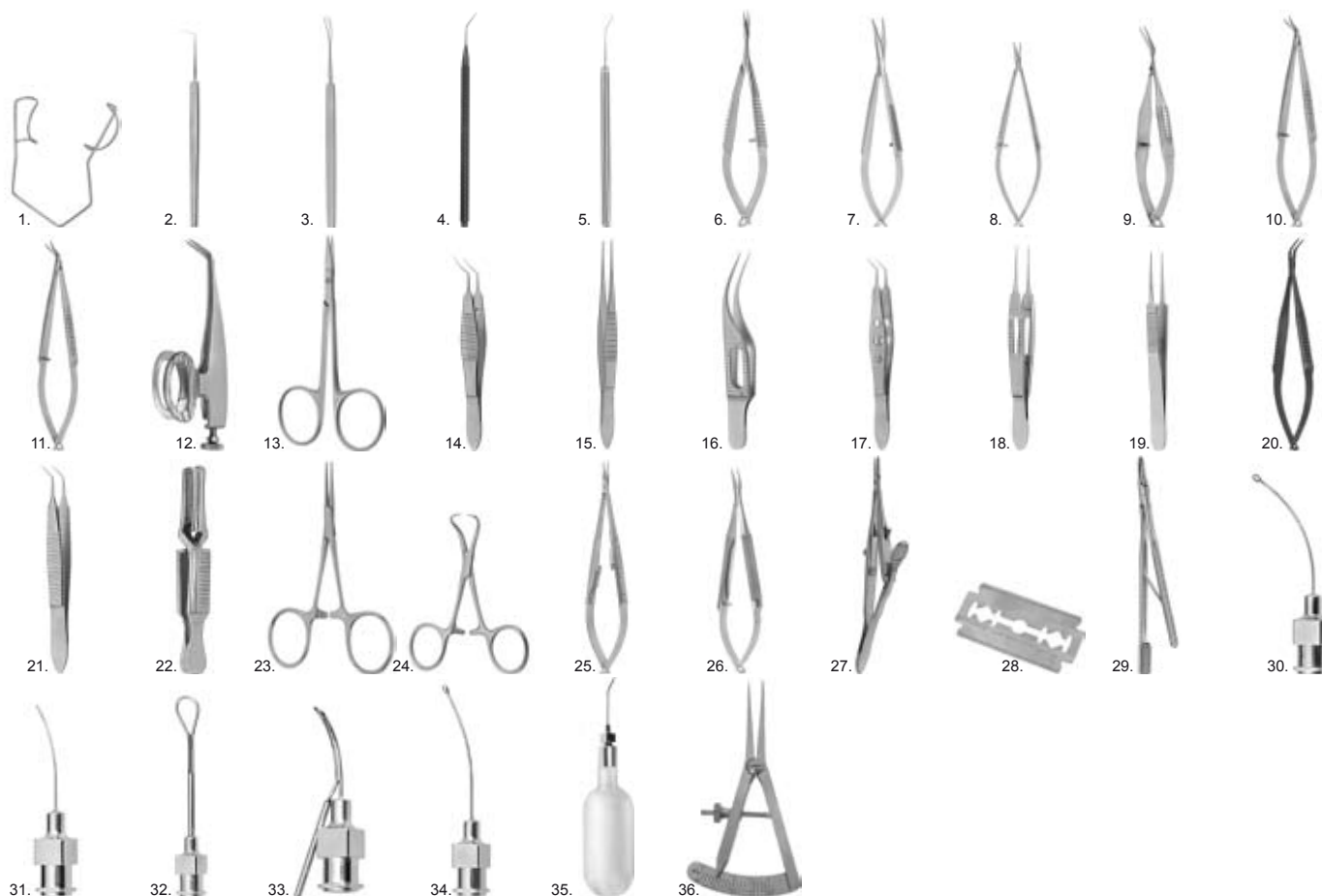
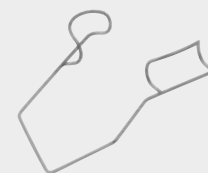

Article No.	Description	Qty.	Page
1.	60-0125 Barraquer-Phaco Eye Speculum	1	2
2.	60-1429 Elschmig Spatula 12.5 cm	1	20
3.	60-1002 Snellen Lens Loop 13 cm	1	25
4.	60-1108 Sinsky IOL Manipulator 12 cm Ti	1	28
5.	60-0540 Dardenne Iris Hook 12 cm	1	29
6.	63-1401 Vannas Micro Scissors 8 cm curved	1	34
7.	63-0360 Westcott Micro Scissors 12 cm	1	35
8.	63-1431 Micro Iris Scissors 10 cm curved	1	35
9.	63-1337 Micro Scissors 8 cm	1	36
10.	63-1055 Troutman Corneoscleral Scissors 10 cm right	1	39
11.	63-1056 Troutman Corneoscleral Scissors 10 cm left	1	39
12.	63-0851 Barraquer Iris Scissors 5.5 cm	1	43
13.	63-0907 Eye Scissors 9 cm curved	1	45
14.	62-1745 Masket Capsulorhexis Forceps 10.5 cm	1	49
15.	09-0080 Tissue Forceps 10 cm 0.7 mm	1	51
16.	62-0922 Micro Colibri Forceps 7.5 cm	1	54
17.	62-0237 Kelman-McPherson Tying Forceps 10 cm	1	55
18.	62-0810 Tuebingen Tying Forceps 10.5 cm straight	1	56

Article No.	Description	Qty.	Page
19.	62-0466 Elschmig Superior Rectus Forceps 10.5 cm	1	59
20.	62-1692 Doden Implantation Forceps 10.5 cm Ti	1	60
21.	62-0246 Bonn Iris Forceps 7 cm angled	1	62
22.	06-0010 Dieffenbach Bulldog Clamps	2	63
23.	06-0050 Hartmann Mosquito Forceps 10cm straight	1	64
24.	07-0100 Backhaus Towel Clamp 9 cm	2	64
25.	62-3740 Castroviejo Standard Micro Needle Holder 13 cm	1	65
26.	62-3732 Barraquer Needle Holder 11.5 cm	1	66
27.	08-0036 Kalt Needle Holder 13.5 cm	1	69
28.	60-1780 Razor Blades	1	72
29.	60-1793 Troutman Bladeholder 9.5 cm	1	73
30.	62-2305 Capsule Polishing Cannula	1	73
31.	60-1518 Sautter Air Injection Cannula 27G curved	2	77
32.	62-2290 Irrigating Vectis Cannula	1	78
33.	62-2240 Simcoe Irrigating-Aspirating Cannula	1	78
34.	62-2309 McIntyre Anterior Chamber Cannula angled	1	79
35.	62-2550 Bishop Harmon Cannula set	1	81
36.	63-1801 Castroviejo Caliper 8 cm, 0-20 mm	1	92

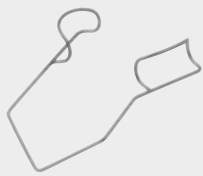

Katarakt Phakoemulsifikation
 Cataract Phacoemulsification
 Catarata Phacoemulsificación
 Cataracte Phacoémulsification
 Facoemulsificazione set cataratta

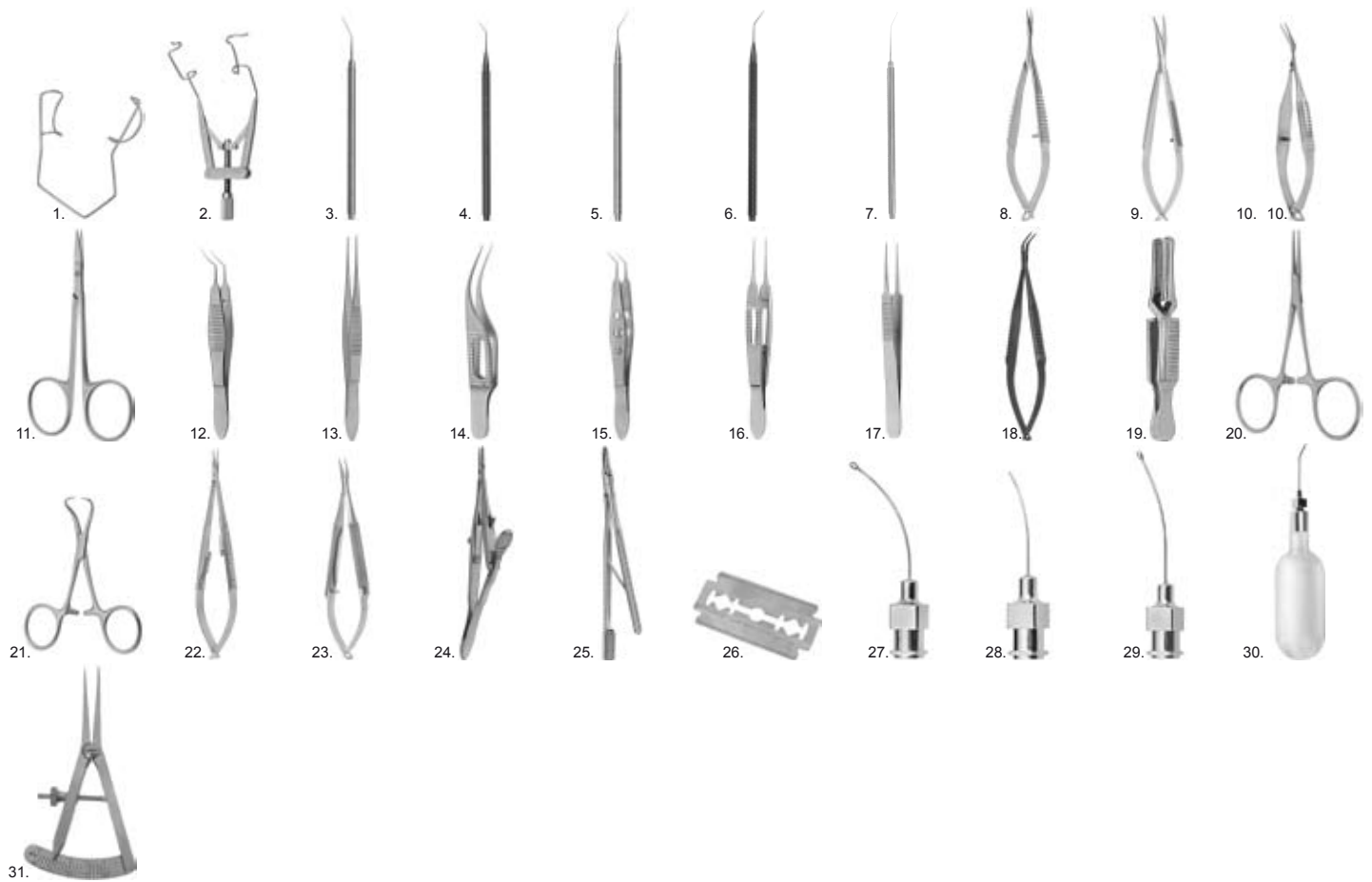

	Article No.	Description	Qty.	Page
1.	60-0125	Barraquer Phaco Eye Speculum	1	2
2.	60-0168	Lieberman Eye Speculum	1	7
3.	60-0688	Mod.Hamburg Keratome 12 cm	1	16
4.	60-0562	Neuhann Lens Nucleus Rotator Ti 12 cm	1	22
5.	60-0549	Nagahara Nucleus Dividing Hook 12 cm	1	26
6.	60-1108	Sinsky IOL Manipulator Ti 12 cm	1	28
7.	60-0540	Dardenne Iris Hook 12 cm	1	29
8.	63-1401	Vannas Micro Scissors 8 cm	1	34
9.	63-0360	Westcott Micro Scissors	1	35
10.	63-1337	Micro Scissors 8 cm	1	36
11.	63-0907	Eye Scissors 9 cm	1	45
12.	62-1745	Masket Capsulorhexis Forceps 10.5 cm	1	49
13.	09-0080	Tissue Forceps 10 cm 0.7 mm	1	51
14.	62-0922	Barraquer Micro Colibri Forceps 7.5 cm	1	54
15.	62-0237	Kelman-McPherson Tying Forceps 10 cm	1	55
16.	62-0810	Tuebingen Tying Forceps 10.5 cm	1	56

	Article No.	Description	Qty.	Page
17.	62-0466	Elschnig Superior Rectus Forceps 10.5 cm	1	59
18.	62-1692	Doden Implantation Forceps 10.5 cm Ti	1	60
19.	06-0010	Dieffenbach Bulldog Clamps	2	63
20.	06-0050	Hartmann Mosquito Forceps 10 cm	1	64
21.	07-0100	Backhaus Towel Clamp 9 cm	2	64
22.	62-3740	Castroviejo Standard Needle Holder 13 cm	1	65
23.	62-3732	Barraquer Needle Holder RH 11.5 cm	1	66
24.	08-0036	Kalt Needle Holder 13.5 cm	1	69
25.	60-1793	Troutman Bladeholder 9.5 cm	1	72
26.	60-1780	Razor Blades	1	72
27.	62-2305	Jensen Capsule Polisher	1	73
28.	60-1518	Sautter Air Injection Cannula	2	77
29.	62-2309	McIntyre Anterior Chamber Cannula	2	79
30.	62-2550	Bishop Harmon Cannula set	1	81
31.	63-1801	Castroviejo Caliper 8 cm 0-20 mm	1	92

Chalazion

Chalazion

Chalazión

Chalazion

Calazio

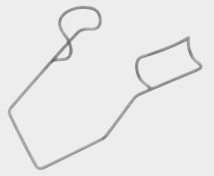

1.



2.



3.



4.



5.



6.



7.



8.



9.

	Article No.	Description	Qty.	Page
1.	60-1323	Jaeger Lid Plate 11cm	1	10
2.	60-0925	Meyhoefer Chalazion Curette ø 1.0 mm	1	18
3.	60-0928	Meyhoefer Chalazion Curette ø 2.0 mm	1	18
4.	60-0929	Meyhoefer Chalazion Curette ø 2.5 mm	1	18
5.	05-0311	Delicate Surgical Scissors 9 cm curved	1	44
6.	62-2810	Desmarres Chalazion Forceps 9cm oval - small	1	50
7.	62-2811	Desmarres Chalazion Forceps 9cm oval - medium	1	50
8.	62-0860	Paufigue Tying Forceps 9 cm	1	56
9.	62-3741	Castroviejo Standard Micro-Needle Holder 13 cm	1	65

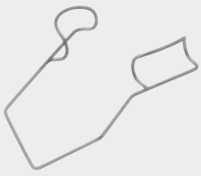

Dacryocystorhinostomie -Tränenweg-
 Dacryocystorhinostomy -Lacrimal-
 Dacriocistorinostomia -vias lacrimales-
 Dacryorhinocystotomie -voies lacrymales-
 Dacriocistorinostomia - set lacrimale-

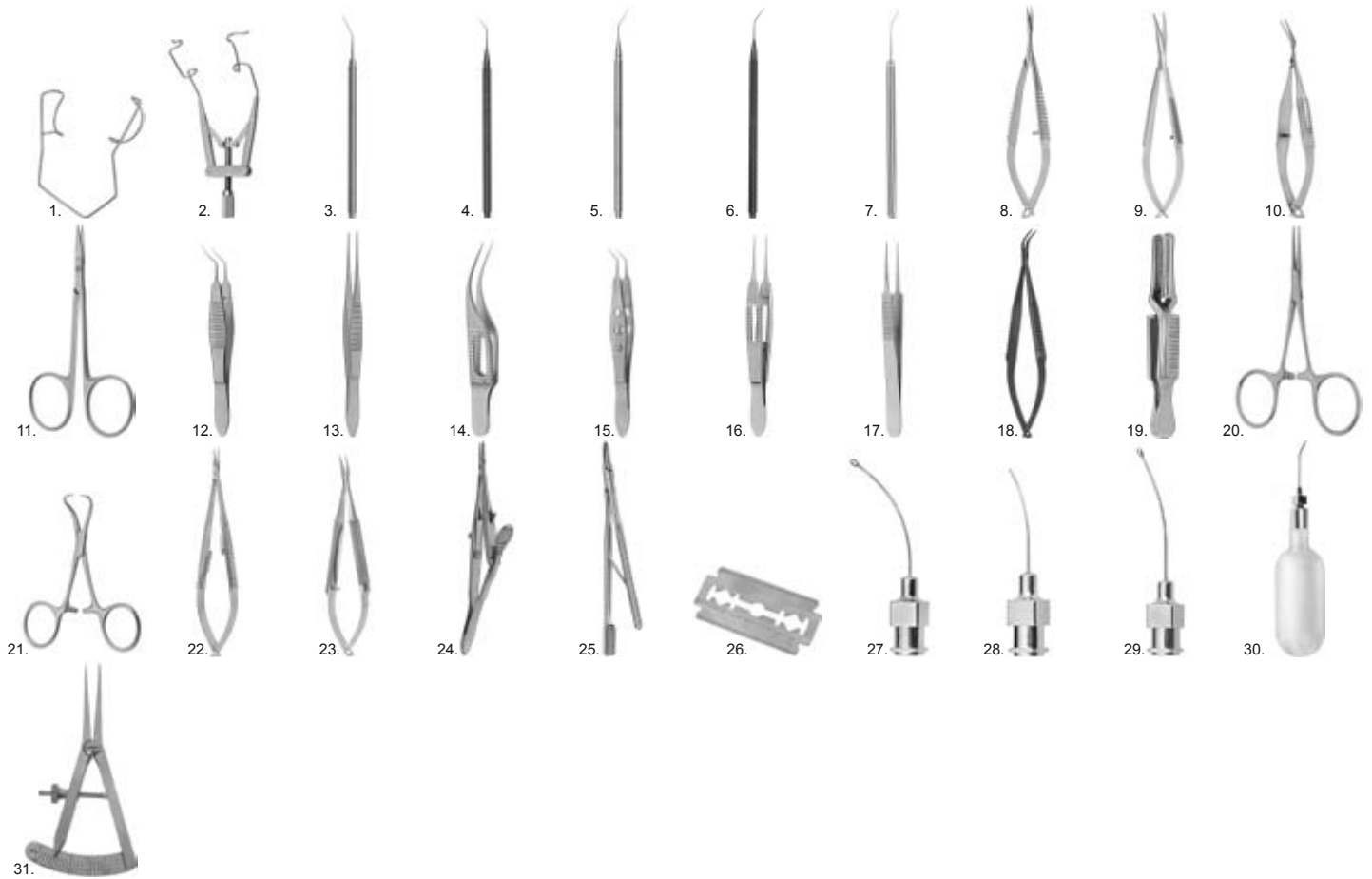

	Article No.	Description	Qty.	Page
1.	60-0125	Barraquer Phaco Eye Speculum	1	2
2.	60-0168	Lieberman Eye Speculum	1	7
3.	60-0688	Mod.Hamburg Keratome 12 cm	1	16
4.	60-0562	Neuhann Lens Nucleus Rotator Ti 12 cm	1	22
5.	60-0549	Nagahara Nucleus Dividing Hook 12 cm	1	26
6.	60-1108	Sinsky IOL Manipulator Ti 12 cm	1	28
7.	60-0540	Dardenne Iris Hook 12 cm	1	29
8.	63-1401	Vannas Micro Scissors 8 cm	1	34
9.	63-0360	Westcott Micro Scissors	1	35
10.	63-1337	Micro Scissors 8 cm	1	36
11.	63-0907	Eye Scissors 9 cm	1	45
12.	62-1745	Masket Capsulorhexis Forceps 10.5 cm	1	49
13.	09-0080	Tissue Forceps 10 cm 0.7 mm	1	51
14.	62-0922	Barraquer Micro Colibri Forceps 7.5 cm	1	54
15.	62-0237	Kelman-McPherson Tying Forceps 10 cm	1	55
16.	62-0810	Tuebingen Tying Forceps 10.5 cm	1	56

	Article No.	Description	Qty.	Page
17.	62-0466	Elschnig Superior Rectus Forceps 10.5 cm	1	59
18.	62-1692	Doden Implantation Forceps 10.5 cm	1	60
19.	06-0010	Dieffenbach Bulldog Clamps	2	63
20.	06-0050	Hartmann Mosquito Forceps 10 cm	1	64
21.	07-0100	Backhaus Towel Clamp 9 cm	2	64
22.	62-3740	Castroviejo Standard Needle Holder 13 cm	1	65
23.	62-3732	Barraquer Needle Holder RH 11.5 cm	1	66
24.	08-0036	Kalt Needle Holder 13.5 cm	1	69
25.	60-1793	Troutman Bladeholder 9.5 cm	1	72
26.	60-1780	Razor Blades	1	72
27.	62-2305	Jensen Capsule Polisher	1	73
28.	60-1518	Sautter Air Injection Cannula	2	77
29.	62-2309	McIntyre Anterior Chamber Cannula	2	79
30.	62-2550	Bishop Harmon Cannula set	1	81
31.	63-1801	Castroviejo Caliper 8 cm 0-20 mm	1	92

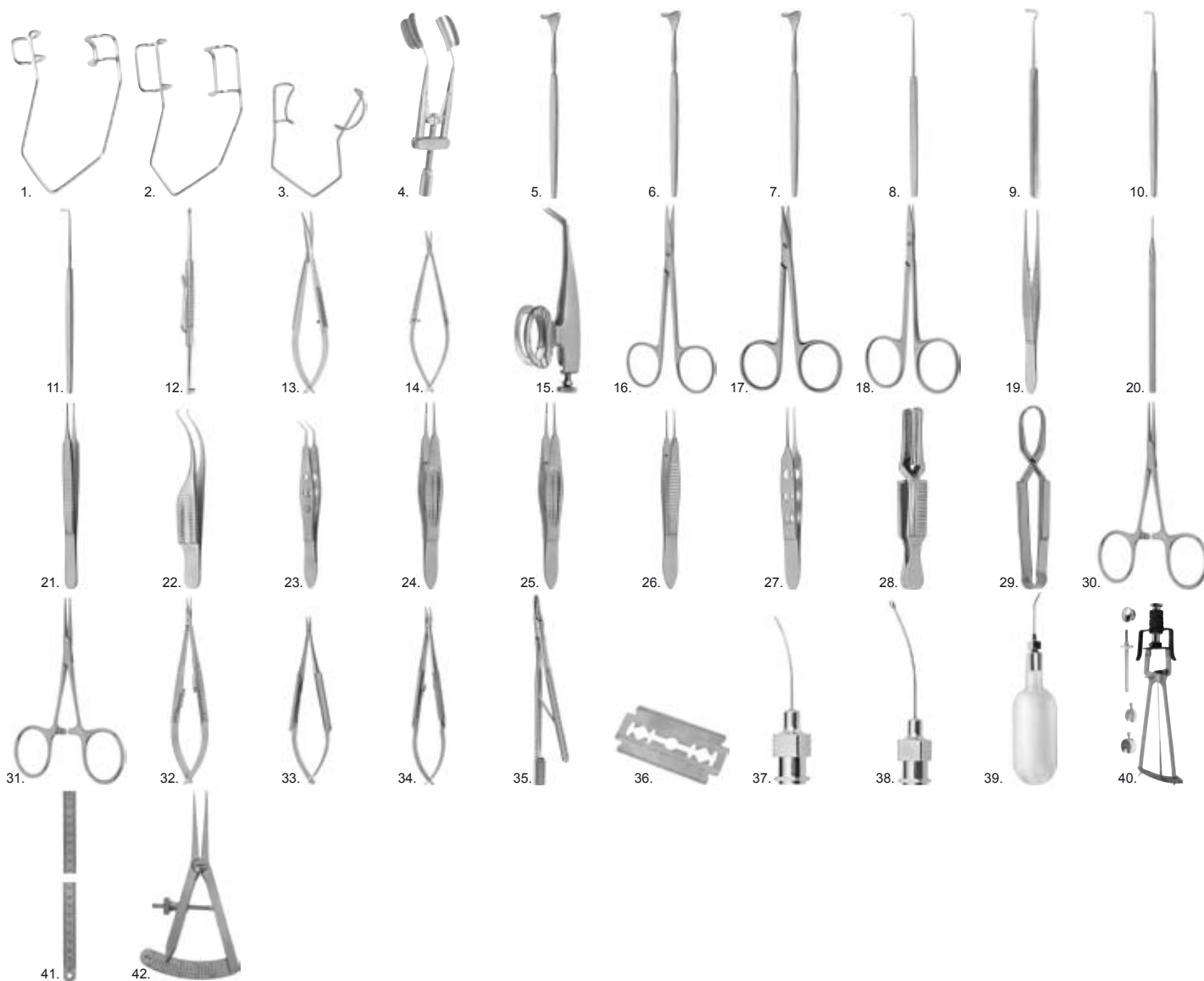
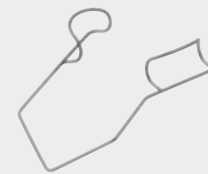

Article No.	Description	Qty.	Page
1.	60-0118 Barraquer-Colibri Eye Speculum for babies	1	2
2.	60-0111 Barraquer-Colibri Eye Speculum, for children	1	2
3.	60-0125 Barraquer Phaco Eye Speculum	1	2
4.	60-0177 Kershner Eye Speculum	1	7
5.	60-1199 Desmarres Lid Retractor 14 cm	1	14
6.	60-1200 Desmarres Lid Retractor 14 cm	1	14
7.	60-1201 Desmarres Lid Retractor 14 cm	1	14
8.	60-1171 Bonn Strabismus Hook 14 cm	1	30
9.	60-1120 Jameson Muscle Hook 13 cm	1	30
10.	60-1111 Graefe Strabismus Hook 14 cm	1	30
11.	60-1113 Graefe Strabismus Hooks 12 cm	1	30
12.	60-1312 Localizer 14 cm	1	31
13.	63-0360 Westcott Micro Scissors 12 cm	1	35
14.	63-1431 Micro Iris Scissors 10 cm curved	1	35
15.	63-0851 Barraquer Iris Scissors 5.5 cm	1	43
16.	05-0310 Delicate Sugical Scissors, 9 cm straight	1	44
17.	63-0431 Stevens Tenotomy Scissors 11 cm curved	1	44
18.	63-0907 Eye Scissors 9 cm curved	1	45
19.	09-0072 Dressing Forceps 10 cm	1	51
20.	60-1229 Fixation Claw, 11 cm	1	53
21.	62-0520 Krefeld (Lester) Conjunctiva Forceps 9.5 cm	1	54
22.	62-0362 Colibri Forceps 7.5 cm with tying platform	1	54

Article No.	Description	Qty.	Page
23.	62-0237 Kelman-McPherson Tying Forceps 10 cm	1	55
24.	62-0750 Castroviejo Suturing Forceps 11 cm	1	58
25.	62-0751 Castroviejo Suturing Forceps 10 cm	1	58
26.	62-0256 Bonn Iris Forceps 9.5 cm	1	62
27.	62-0230 Bishop-Harmon Iris Forceps 8.5cm	1	62
28.	06-0010 Dieffenbach Bulldog Clamps	2	63
29.	07-0139 Schaedel Towel Clamp 9 cm	2	64
30.	06-0050 Hartmann Mosquito Forceps 10cm straight	2	64
31.	06-0051 Hartmann Mosquito Forceps 10cm curved	2	64
32.	62-3740 Castroviejo Standard Micro Needle Holder 13 cm	1	65
33.	62-3871 Jacobi Micro Needle Holder 11.5 cm	1	67
34.	62-3786 Barraquer Micro Needle Holder, 13.5 cm	1	68
35.	60-1793 Troutman Bladeholder 9.5 cm	1	72
36.	60-1780 Razor Blades	1	72
37.	60-1518 Sautter Air Injection Cannula 27G curved	1	77
38.	62-2309 McIntyre Anterior Chamber Cannula angled	1	79
39.	62-2550 Bishop Harmon Cannula set	1	81
40.	63-2405 Schioetz Tonometer with inclined scale	1	92
41.	18-0161 Ruler 150 mm	1	92
41.	63-1801 Castroviejo Caliper 8 cm, 0-20 mm	1	92

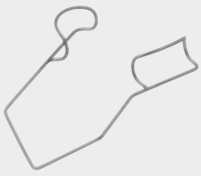

Enucleation
 Enucleation
 Enucleación
 Énucléation
 Enucleazione



1.



2.



3.



4.



5.



6.



7.



8.



9.



10.



11.



12.



13.



14.



15.

	Article No.	Description	Qty.	Page
1.	60-0216	Cook Eye Speculum 15 mm solid blades adult	1	5
2.	60-1068	Bunge Evisceration Spoon RH medium	1	18
3.	60-1055	Wells Enucleation Spoon large	1	22
4.	60-1112	Graefe Strabismus Hook 14.5 cm	1	30
5.	63-0513	Enucleation Scissors 13 cm curved	1	40
6.	05-0311	Delicate Surgical Scissors 9 cm curved	1	44
7.	63-0431	Stevens Tenotomy Scissors 11 cm curved	1	44
8.	09-0351	Graefe Fixation Forceps 11 cm	1	52
9.	62-0860	Paufique Tying Forceps 9 cm	1	56
10.	62-3275	Bangerter Muscle Clamp 9.5 cm	1	59
11.	07-0100	Backhaus Towel Clamp 9 cm	2	64
12.	06-0090	Micro-Halsted Artery Forceps 12 cm straight	2	64
13.	06-0091	Micro-Halsted Artery Forceps 12 cm curved	2	64
14.	62-3741	Castroviejo Standard Micro-Needle Holder 13 cm	1	65
15.	60-2220	Carter Sphere Introducer and Holder 12.5 cm	1	95

Fremdkörper

Foreign Body

Cuerpos extraños

Extraction des corps étrangers

Rimozione corpi estranei

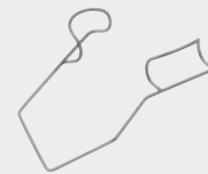

1.



2.



3.

	Article No.	Description	Qty.	Page
1.	60-0109	Barraquer-Colibri Eye Speculum	1	2
2.	60-0925	Meyhoefer Chalazion Curette 13 cm, ø 1.0 mm	1	18
3.	60-0866	Needle and Chisel 11 cm	1	33

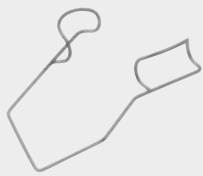

Glaukom
 Glaucoma
 Glaucoma
 Glaucoma
 Glaucoma

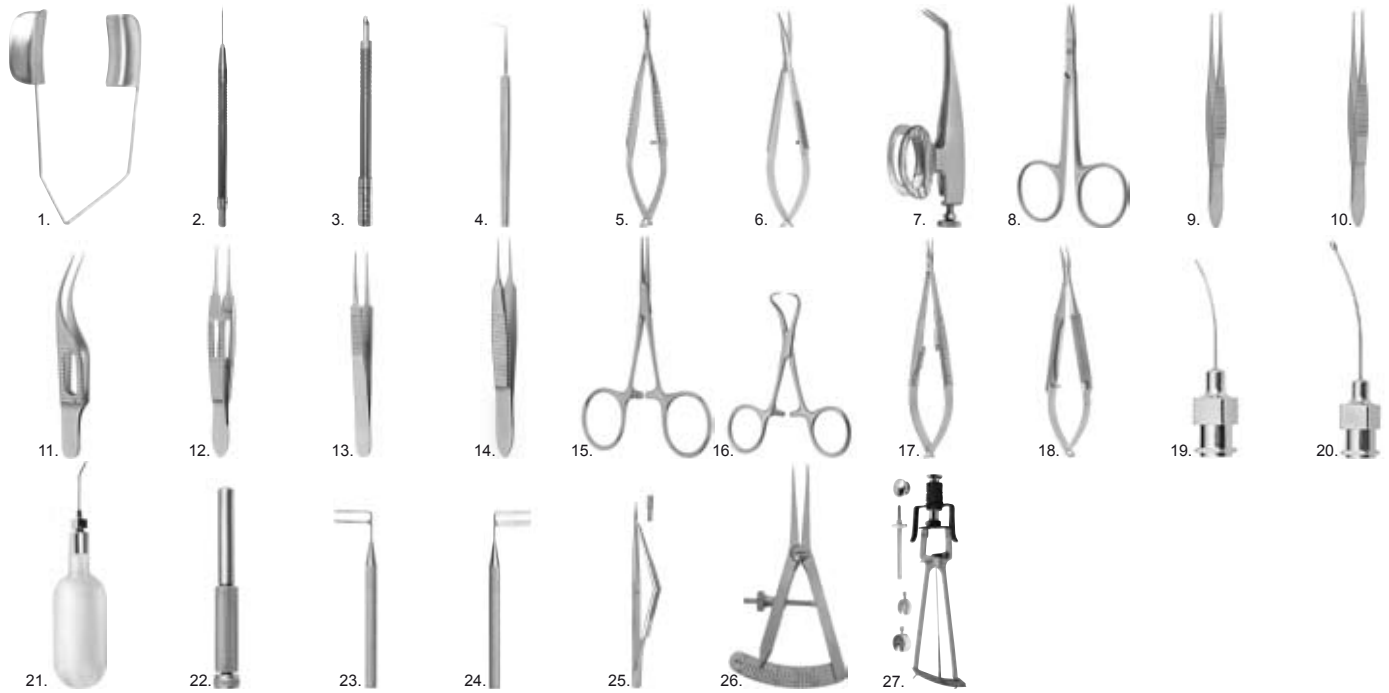

	Article No.	Description	Qty.	Page
1.	60-0255	Barraquer Eye Speculum 8 mm	1	2
2.	60-0623	Premium Diamond Knife	1	14
3.	60-0602	Premium Diamond Knife	1	14
4.	60-1429	Elschnig Spatula 12.5 cm	1	20
5.	63-1407	Vannas Mod.Tübingen Micro Scissors	1	34
6.	63-0360	Westcott Micro Scissors 11 cm	1	35
7.	63-0851	Barraquer Iris Scissors 5.5 cm	1	43
8.	63-0907	Eye Scissors 9 cm curved	1	45
9.	09-0026	Graefe Tissue Forceps 10 cm 0,5 mm straight	1	51
10.	09-0080	Graefe Tissue Forceps 10 cm 0,7 mm straight	1	51
11.	62-0922	Micro Colibri Forceps 7.5 cm	1	54
12.	62-0810	Tuebingen Tying Forceps 10.5 cm straight	2	56
13.	62-0466	Elschnig Superior Rectus Forceps 10.5 cm	1	59
14.	62-0244	Bonn Iris Forceps 7cm straight	1	62
15.	06-0050	Hartmann Mosquito Forceps 10 cm	1	64
16.	07-0100	Backhaus Towel Clamp 9 cm	2	64
17.	62-3740	Castroviejo Standard Needle Holder 13 cm	1	65
18.	62-3732	Barraquer Needle Holder 11.5 cm	1	66
19.	60-1518	Sautter Air Injection Cannula	2	77
20.	62-2309	McIntyre Anterior Chamber Cannula	2	79
21.	62-2550	Bishop Harmon Cannula set	1	81
22.	63-1540	Elliot Scleral Trephine \varnothing 1.0 mm	1	82
23.	63-2306	Harms Trabeculotomy Probe right	1	86
24.	63-2305	Harms Trabeculotomy Probe left	1	86
25.	60-2254	Kelly Descemet's Membrane	1	90
26.	63-1801	Castroviejo Caliper 0-20 mm	1	92
27.	63-2405	Schioetz Tonometer with inclined scale	1	92

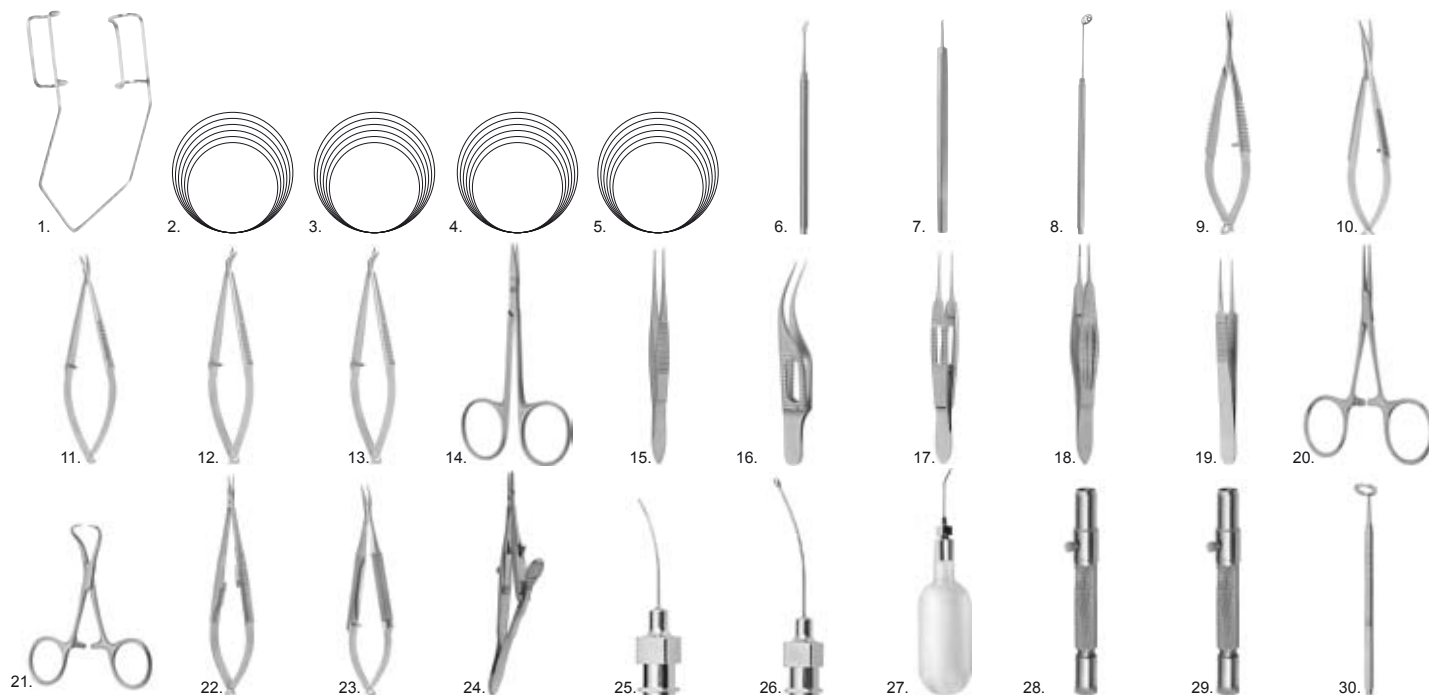
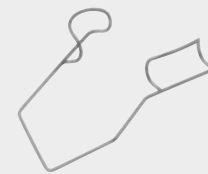

	Article No.	Description	Qty.	Page
1.	60-0109	Barraquer-Colibri Eye Speculum	1	2
2.	60-1285	Walter Bulb Fixation Ring ø 15 mm	1	12
3.	60-1286	Walter Bulb Fixation Ring ø 16 mm	1	12
4.	60-1288	Walter Bulb Fixation Ring ø 18 mm	1	12
5.	60-1290	Walter Bulb Fixation Ring ø 20 mm	1	12
6.	60-0662	Bonn Scleral Knife 12.5 cm	1	15
7.	60-0766	Paufique Keratoplastic Knife 10.5 cm	1	15
8.	60-1745	Keratoplasty Ethmoid Spatula 13 cm	1	22
9.	63-1401	Vannas Micro Scissors 8 cm curved	1	34
10.	63-0360	Westcott Micro Scissors 12 cm	1	35
11.	63-1434	Micro Scissors 10 cm	1	37
12.	63-1170	Katzin Keratoplasty Scissors 9.5 cm, right	1	38
13.	63-1171	Katzin Keratoplasty Scissors 9.5 cm, left	1	38
14.	63-0907	Eye Scissors 9 cm curved	1	45
15.	09-0080	Tissue Forceps 10 cm 0.7 mm	1	51

	Article No.	Description	Qty.	Page
16.	62-0922	Micro Colibri Forceps 7.5 cm	1	54
17.	62-0810	Tuebingen Tying Forceps 10.5 cm straight	2	56
18.	62-0751	Castroviejo Suturing Forceps 10 cm	1	58
19.	62-0466	Elschnig Superior Rectus Forceps 10.5 cm	1	59
20.	06-0050	Hartmann Mosquito Forceps 10cm straight	1	64
21.	07-0100	Backhaus Towel Clamp 9 cm	2	64
22.	62-3740	Castroviejo Standard Micro Needle Holder 13 cm	1	65
23.	62-3732	Barraquer Needle Holder 11.5 cm	1	66
24.	08-0036	Kalt Needle Holder 13.5 cm	1	69
25.	60-1518	Sautter Air Injection Cannula 27G curved	2	77
26.	62-2309	McIntyre Anterior Chamber Cannula angled	1	79
27.	62-2550	Bishop Harmon Cannula set	1	81
28.	63-0064	Franceschetti Keratoplasty Trephine ø 7.0mm	1	83
29.	63-0066	Franceschetti Keratoplasty Trephine ø 8.0mm	1	83
30.	60-0920	Anis Suture Placement Marker 10.5 cm	1	89

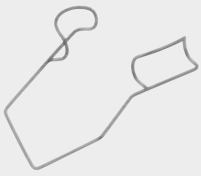

Lasik
Lasik
Lasik
Lasik
Lasik



	Article No.	Description	Qty.	Page
1.	60-0168	Lieberman Eye Speculum	1	7
2.	60-0169	Lieberman Aspirating Eye Speculum	1	8
3.	60-0800	Swivel Fixation Ring 11.5 cm	1	12
4.	60-0573	Amon Phaco Spatula 10.5 cm	1	20
5.	60-1386	Castroviejo Cyclodialysis Spatula 13 cm	1	20
6.	60-1312	Localizer 14 cm	1	31
7.	62-0212	Buratto Lasik Flap Forceps 10 cm	1	60
8.	60-1518	Sautter Air Injection Cannula 27G curved	1	77
9.	62-2242	Brauweiler Irrigating Cannula 21G angled	1	79
10.	60-0910	Chayet Corneal Marker for Lasik 10.5 cm	1	89

Lid-Bindehaut Trichiasis - Ptosis

Lid-Conjunctiva Trichiasis - Ptosis

Párpado conjuntival triquiiasis - Ptosis

Paupières Trichiasis - Ptosis

Palpebra - set per ptosi e trichiasis

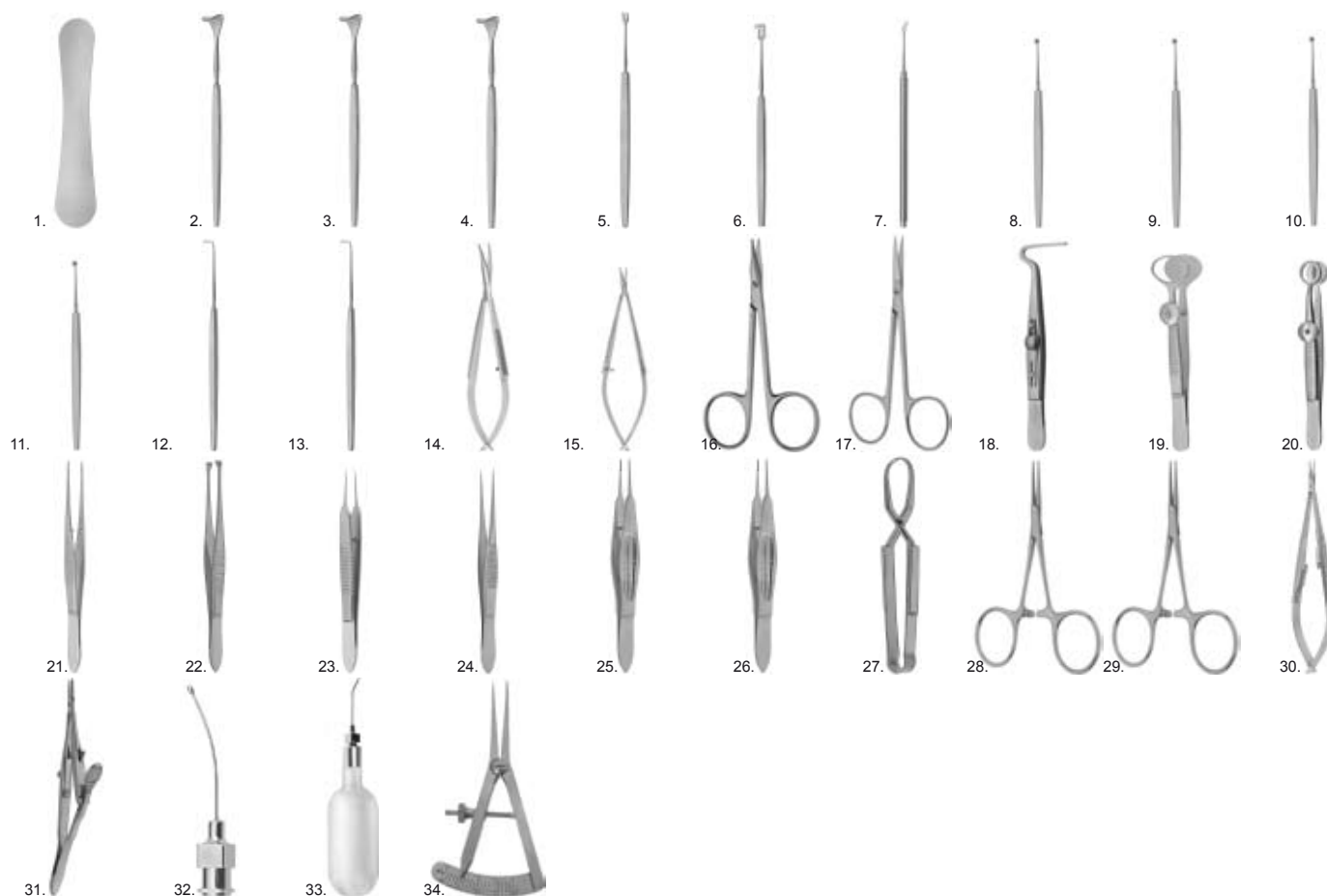
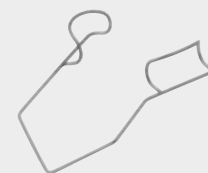

Article No.	Description	Qty.	Page
1.	60-1323 Jaeger Lid Plate 11cm	1	10
2.	60-1200 Desmarres Lid Retractor 14 cm	1	10
3.	60-1201 Desmarres Lid Retractor 14 cm	1	10
4.	60-1202 Desmarres Lid Retractor 14 cm	1	10
5.	60-1220 Guthrie Skin Retractor (Iris Hook) sharp, 13 cm	1	11
6.	63-2973 Axenfeld Retractor 14 cm	1	11
7.	60-0662 Bonn Scleral Knife 12.5 cm	1	15
8.	60-0925 Meyhoefer Chalazion Curette ø 1.0 mm	1	18
9.	60-0928 Meyhoefer Chalazion Curette ø 2.0 mm	1	18
10.	60-0929 Meyhoefer Chalazion Curette ø 2.5 mm	1	18
11.	60-0930 Meyhoefer Chalazion Curette ø 3.0 mm	1	18
12.	60-1110 Graefe Strabismus Hook 13 cm	1	30
13.	60-1111 Graefe Strabismus Hook 14 cm	1	30
14.	63-0360 Westcott Micro Scissors 12 cm	1	35
15.	63-1431 Micro Iris Scissors 10 cm curved	1	35
16.	63-0421 Stevens Tenotomy Scissors 10.5cm curved	1	44
17.	05-0314 Delicate Surgical Scissors 10.5 cm	1	44
18.	62-3281 Berke Ptosis Forceps 11cm with lock	1	50

Article No.	Description	Qty.	Page
19.	62-2811 Desmarres Chalazion Forceps 9cm oval - medium	1	50
20.	62-2800 Lambert Chalazion Forceps 9cm	1	50
21.	09-0071 Dressing Forceps 9.5 cm	1	51
22.	09-0351 Graefe Fixation Forceps 11 cm	1	52
23.	62-0832 Tuebingen Tying Forceps Curved 10cm	1	56
24.	09-0968 Cilia- and Foreign Body Forceps 10 cm	1	57
25.	62-0750 Castroviejo Suturing Forceps 11 cm	1	58
26.	62-0751 Castroviejo Suturing Forceps 10 cm	1	58
27.	07-0139 Schaedel Towel Clamp 9 cm	2	64
28.	06-0050 Hartmann Mosquito Forceps 10cm straight	2	64
29.	06-0051 Hartmann Mosquito Forceps 10cm curved	2	64
30.	62-3741 Castroviejo Standard Micro-Needle Holder 13 cm	1	65
31.	08-0036 Kalt Needle Holder 13.5 cm	1	69
32.	62-2309 McIntyre Anterior Chamber Cannula angled	1	79
33.	62-2550 Bishop Harmon Cannula set	1	81
34.	63-1801 Castroviejo Caliper 8 cm, 0-20 mm	1	92

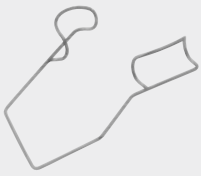

Pterygium

Pterygium

Eterigio

Pterygion

Pterigio



1.



2.



3.



4.



5.



6.



7.



8.



9.

	Article No.	Description	Qty.	Page
1.	60-0207	Weiss Eye Speculum 8 cm	1	4
2.	60-1199	Desmarres Lid Retractor 14 cm	1	10
3.	60-0662	Bonn Scleral Knife 12.5 cm	1	15
4.	05-0310	Delicate Sugical Scissors, 9 cm straight	1	44
5.	62-0464	Barraquer Fixation Forceps 10 cm	1	51
6.	09-0072	Dressing Forceps 10 cm	1	51
7.	09-0080	Tissue Forceps 10 cm 0.7 mm	1	51
8.	62-0860	Paufique Tying Forceps 9 cm	1	56
9.	62-3736	Castroviejo Standard Needle Holder 14 cm curved	1	65

Radiale Keratotomie

Radial Keratotomy

Queratotomía radial

Kératotomie radiaire

Cheratomia radiale

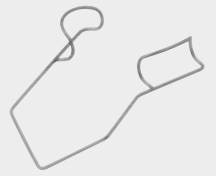

1.



2.



3.



4.



5.



6.



7.



8.



9.



10.



11.

	Article No.	Description	Qty.	Page
1.	60-0125	Barraquer Phaco Eye Speculum	1	2
2.	60-0802	Swivel Fixation Ring ø16mm, 12 cm	1	12
3.	60-0606	Diamond Knife for Keratotomy with Micrometer, Blade 45°, 1,0 mm	1	14
4.	62-0362	Colibri Forceps 7.5 cm with tying platform	1	54
5.	60-1518	Sautter Air Injection Cannula 27G curved	2	77
6.	60-0970	Hoffer Corneal Marker for optic zone 3.0 mm, 10.5 cm	1	88
7.	60-0971	Hoffer Corneal Marker for optic zone 3.25 mm, 10.5 cm	1	88
8.	60-0974	Hoffer Corneal Marker for optic zone 4.0 mm, 10.5 cm	1	88
9.	60-0976	Hoffer Corneal Marker for optic zone 5.0 mm, 10.5 cm	1	88
10.	60-0980	Hoffer Corneal Marker for optic zone 7.0 mm, 10.5 cm	1	88
11.	60-0920	Anis Suture placement marker 11.5 cm	1	88

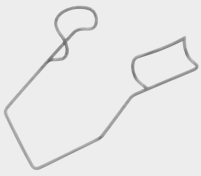

Fadenentfernung

Stitch Removal

Retirar suturas

Enlever les fils

Rimozione punti



1.



2.



3.

	Article No.	Description	Qty.	Page
1.	60-0109	Barraquer-Colibri Eye Speculum	1	2
2.	63-1401	Vannas Micro Scissors 8 cm curved	1	34
3.	62-0940	Barraquer Suture Removal Forceps 7.5 cm	1	56

Strabismus

Strabismus / Muscle

Estrabismo

Strabisme

Strabismo

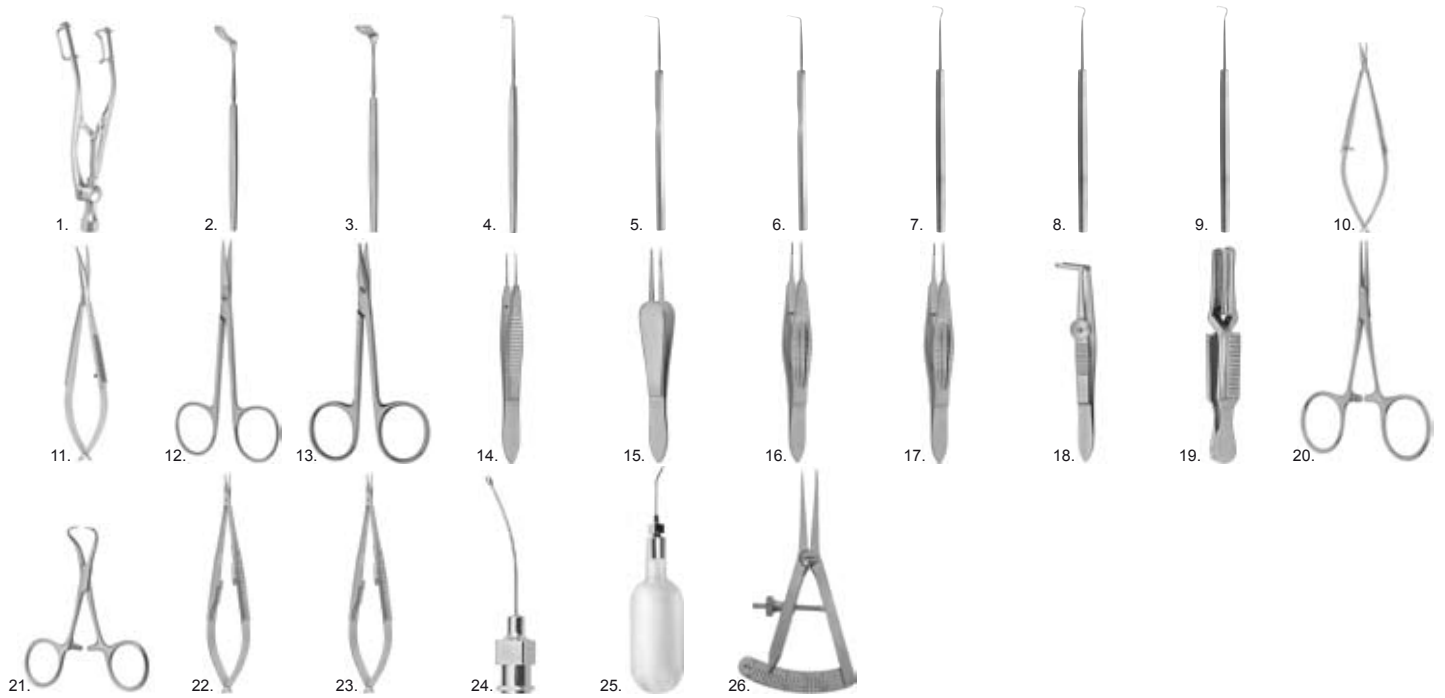
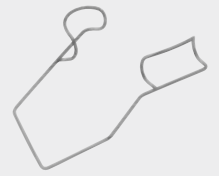

	Article No.	Description	Qty.	Page
1.	60-0161	Castroviejo Eye Speculum	1	7
2.	60-1495	Orbital Spatula 15cm	1	21
3.	60-1496	Hamburg Orbital Spatula 14 cm	1	21
4.	60-1113	Graefe Strabismus Hooks 12 cm	1	30
5.	60-1186	Helveston Muscle Hooks 12.5 cm, 13 mm	1	30
6.	60-1185	Helveston Muscle Hooks 12.5 cm, 8 mm	1	30
7.	60-1190	Helveston Muscle Hook 8mm, 14 cm	1	30
8.	60-1191	Helveston Muscle Hook 10 mm, 14 cm	1	30
9.	60-1192	Helveston Muscle Hook 12 mm, 14 cm	1	30
10.	63-1431	Micro Iris Scissors 10 cm curved	1	35
11.	63-0360	Westcott Micro Scissors 12 cm	1	35
12.	05-0310	Delicate Sugical Scissors, 9 cm straight	1	44
13.	63-0421	Stevens Tenotomy Scissors 10.5cm curved	1	44
14.	62-0256	Bonn Iris Forceps 9.5 cm	1	62
15.	62-0860	Paufique Tying Forceps 9 cm	1	56
16.	62-0751	Castroviejo Suturing Forceps 10 cm	1	58
17.	62-0750	Castroviejo Suturing Forceps 11 cm	1	58
18.	62-3275	Bangerter Muscle Forceps 9.5 cm	1	59
19.	06-0010	Dieffenbach Bulldog Clamps	1	63
20.	06-0050	Hartmann Mosquito Forceps 10cm straight	1	64
21.	07-0100	Backhaus Towel Clamp 9 cm	1	64
22.	62-3741	Castroviejo Standard Micro-Needle Holder 13 cm	1	65
23.	62-3740	Castroviejo Standard Micro Needle Holder 13 cm	1	65
24.	62-2309	McIntyre Anterior Chamber Cannula angled	1	79
25.	62-2550	Bishop Harmon Cannula set	1	81
26.	63-1801	Castroviejo Caliper 8 cm, 0-20 mm	1	92

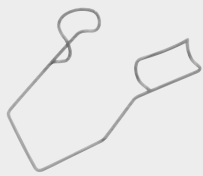

Vitrektomie -Pars Plana-
 Vitrectomy -Pars Plana-
 Vitrectomia -Pars Plana-
 Vitrectomie -Pars Plana-
 Vitrectomia -pars plana-

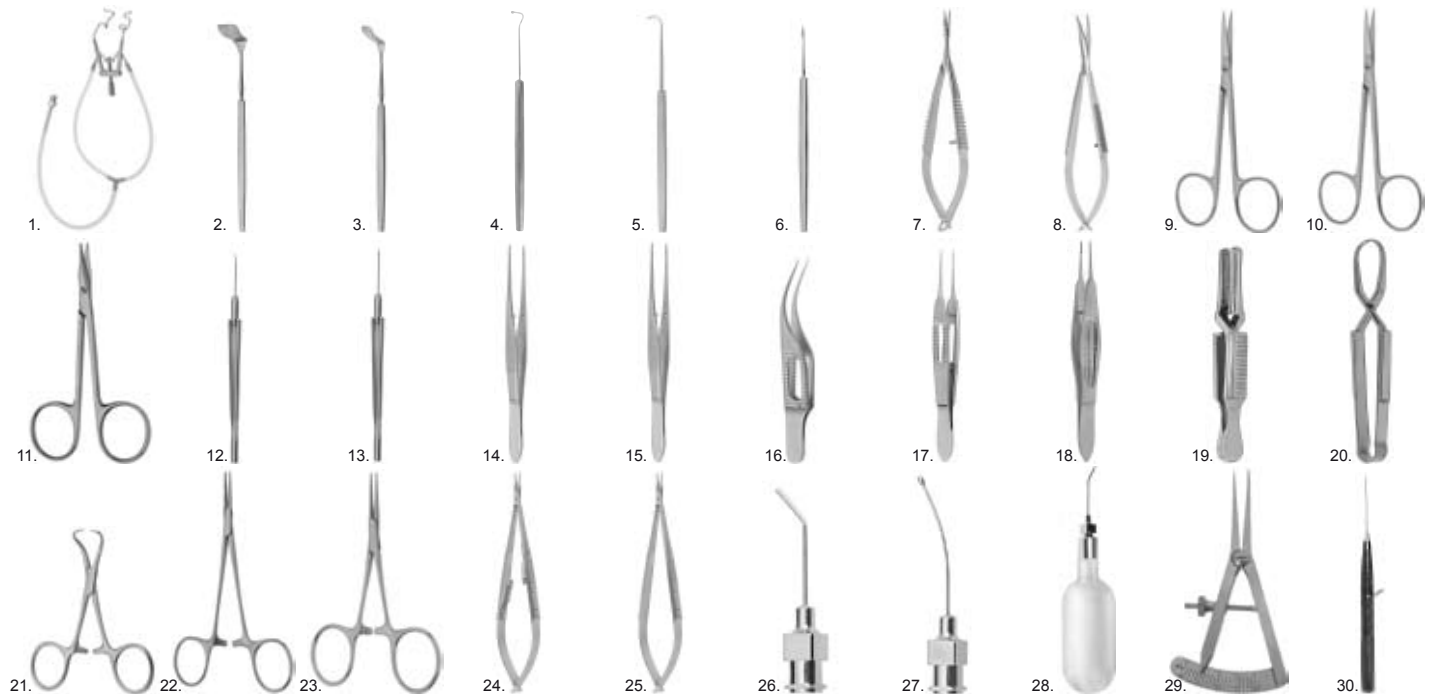

	Article No.	Description	Qty.	Page
1.	60-0169	Lieberman Aspirating Eye Speculum	1	8
2.	60-1431	Sautter Orbital Spatula medium 15 cm	1	21
3.	60-1495	Orbital Spatula 15cm	1	21
4.	60-1120	Jameson Muscle Hook 13 cm	2	30
5.	60-1171	Bonn Strabismus Hook 14 cm	2	30
6.	60-0895	Foreign Body Needle 12.5 cm	1	32
7.	63-1400	Vannas Capsulotomy Scissors 8 cm	1	34
8.	63-0360	Westcott Micro Scissors 12 cm	1	35
9.	05-0310	Delicate Sugical Scissors, 9 cm straight	1	44
10.	05-0311	Delicate Surgical Scissors 9 cm curved	1	44
11.	63-0430	Stevens Tenotomy Scissors 11 cm straight	1	44
12.	62-1133	Vitrectomy Forceps straight serrated 14.5 cm	1	47
13.	62-1132	Vitrectomy Scissors straight 14.5 cm	1	47
14.	09-0072	Dressing Forceps 10 cm	1	51
15.	09-0071	Dressing Forceps 9.5 cm	1	51
16.	62-0922	Micro Colibri Forceps 7.5 cm	1	54
17.	62-0810	Tuebingen Tying Forceps 10.5 cm straight	2	56

	Article No.	Description	Qty.	Page
18.	62-0751	Castroviejo Suturing Forceps 10 cm	2	58
19.	06-0010	Dieffenbach Bulldog Clamps	2	63
20.	07-0139	Jones Towel Clamp 8.5cm	2	64
21.	07-0100	Backhaus Towel Clamp 9 cm	2	64
22.	06-0090	Micro-Halsted Artery Forceps 12 cm straight	2	64
23.	06-0050	Hartmann Mosquito Forceps 10cm straight	2	64
24.	62-3740	Castroviejo Standard Micro Needle Holder 13 cm	1	65
25.	62-3736	Castroviejo Standard Needle Holder 14cm curved	1	65
26.	60-1477	Healon Cannula 21G	1	74
27.	62-2309	McIntyre Anterior Chamber Cannula angled	1	79
28.	62-2550	Bishop Harmon Cannula set	1	81
29.	63-1801	Castroviejo Caliper 8 cm, 0-20 mm	1	92
30.	60-2224	Holder and Inserter for Sclera Pins	1	95
31.	60-2225	Heimann Sclera Pin package 6 pieces Ti	1	95

Ablatio

Ablatio - Retinal Detachment

Décollement de rétine - ablatio retiane

Desprendimiento de retina - ablatio retinae

Distaccoamento retina - ablatio retina

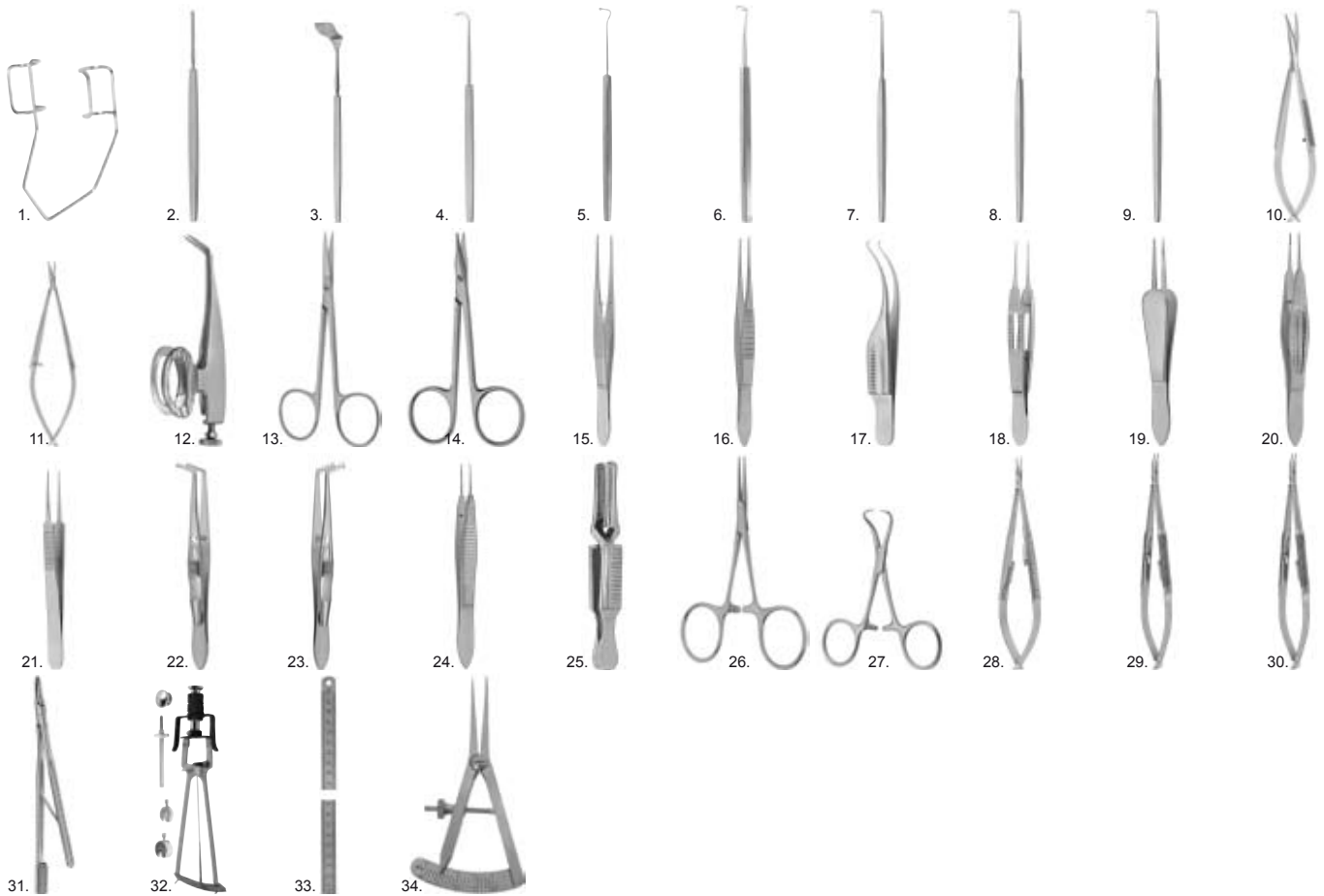
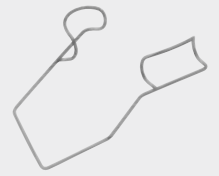

Article No.	Description	Qty.	Page
1.	60-0111 Barraquer-Colibri Eye Speculum, for children	1	2
2.	60-1405 Elschnig Irisspatel 10mm 13cm	1	19
3.	60-1431 Sautter Orbital Spatula medium 15 cm	1	21
4.	60-1171 Bonn Strabismus Hook 14 cm	1	30
5.	60-1120 Jameson Muscle Hook 13 cm	1	30
6.	60-1117 Malbran Strabismus Hooks 12.5 cm	1	30
7.	60-1110 Graefe Strabismus Hook 13 cm	1	30
8.	60-1111 Graefe Strabismus Hook 14 cm	1	30
9.	60-1112 Graefe Strabismus Hook 14.5 cm	1	30
10.	63-0360 Westcott Micro Scissors 12 cm	1	35
11.	63-1431 Micro Iris Scissors 10 cm curved	1	35
12.	63-0851 Barraquer Iris Scissors 5.5 cm	1	43
13.	05-0310 Delicate Sugical Scissors, 9 cm straight	1	44
14.	63-0421 Stevens Tenotomy Scissors 10.5cm curved	1	44
15.	09-0072 Dressing Forceps 10 cm	1	51
16.	09-0080 Tissue Forceps 10 cm 0.7 mm	1	51
17.	62-0362 Colibri Forceps 7.5 cm with tying platform	1	54

Article No.	Description	Qty.	Page
18.	62-0810 Tuebingen Tying Forceps 10.5 cm straight	1	56
19.	62-0860 Paufigue Tying Forceps 9 cm	1	56
20.	62-0750 Castroviejo Suturing Forceps 11 cm	1	58
21.	62-0466 Elschnig Superior Rectus Forceps 10.5 cm	1	59
22.	62-3255 Sattler Muscle Forceps 10 cm left	1	59
23.	62-3256 Sattler Muscle Forceps 10 cm right	1	59
24.	62-0256 Bonn Iris Forceps 9.5 cm	1	62
25.	06-0010 Dieffenbach Bulldog Clamps	2	63
26.	06-0051 Hartmann Mosquito Forceps 10cm curved	1	64
27.	07-0100 Backhaus Towel Clamp 9 cm	2	64
28.	62-3740 Castroviejo Standard Micro Needle Holder 13 cm	1	65
29.	62-3755 Barraquer Needle Holder 11.5 cm smooth	1	66
30.	62-3756 Barraquer Needle Holder 11.5 cm smooth, cvd	1	66
31.	60-1793 Troutman Bladeholder 9.5 cm	1	72
32.	63-2405 Schioetz Tonometer with inclined scale	1	92
33.	18-0161 Ruler 150 mm	1	92
34.	63-1801 Castroviejo Caliper 8 cm, 0-20 mm	1	92

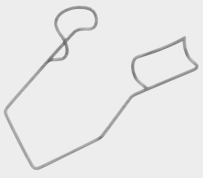

Notizen

Notes

Notas

Notes

Note

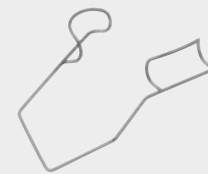

A

Absaugkanülen	80
AMON Phakospatel	20
AMSLER Kapselpolierkanüle	75
Anatomische, feine Pinzetten	51
ANEL Tränenwegkanülen	76
ANIS Nahtplatzierungsmarkeur	89
ARLT Starschlingen	25
ARRUGA Kapselpinzetten	49
ARRUGA Nadelhalter	69
Arterienklemmen	64
Arterienklemmen, fein	64
Augenbrause	78
Augenkanülen	74-75
Augenkauter	87
Augenklappen	89
Augenmesser	15-17
Augenscheren	45-46
AXENFELD Chalazionlöffel	18
AXENFELD Nadelhalter	70
AXENFELD Wundhaken	11
AYER Chalazionspinzette	50

B

BACKHAUS Tucklemme	64
Bandspreizpinzette	55
BANGERTER Iris spatel	19
BANGERTER Lidsperrerr	4
BANGERTER Muskelpinzette	59
BANGERTER Spatel	21
BANGERTER Tränenwegsondenkanülen	74
BARKAN Goniotomiemesser	17
BARRAQUER Cilienpinzetten	57
BARRAQUER Fadenlöspinzette	56
BARRAQUER Fasspinzette	61
BARRAQUER Fixierpinzette	53
BARRAQUER Iridektomieschere	43
BARRAQUER Lidsperrerr	2
BARRAQUER Mikro-Nadelhalter	66, 68
BARRAQUER Rasierklingshalter und -brecher	72
BARRAQUER-CASTROVIEJO Zyklodialysenspatel	20
BARRAQUER-FRANKFURT Lidsperrerr	2
BARRAQUER-KRATZ Lidsperrerr	2
BARRAQUER-OOSTERHUIS Lidsperrerr	3
BARRAQUER-OOSTERHUIS-KRATZ Lidsperrerr	3
BARRAQUER-TROUTMAN Mikro-Nadelhalter	67
BARSEWISCH VON Vorderkammerpinzette	49
BEARD-MELLINGER Lidsperrerr	6
BEER Cilienpinzette	57
Behälter, Sterilisier-	93
BERKE Ptosispinzette	50
BEST KeratoplastikTrepshin	83
BEST Trepshin	82
BEYER Knochenstanzen	91
Bindehautpinzetten	54
BINKHORST Spatel	20
BINKHORST Spülkanüle	79
BISHOP-HARMON Irispinzetten	62
BONN Irishäkchen	29
BONN Irispinzetten	62
BONN Irispinzetten, fein gerieft	63
BONN Schielhaken	30
BONN Skleramesser	15
BONN Spülkanülen	79
BONN Strabismussschere	41
BOWMAN Diszisionsnadeln	17
BOYNTON Nadelhalter	70
Brause, Augen-	78
BRAUWEILER Erweiterungsmesser für IOL	15
BRAUWEILER Saugkanülenhandgriffe	80
BRAUWEILER Spülkanüle	79
BRAUWEILER TITAN LINE Saugkanülenhandgriff	80
BREMEN TITAN LINE Linsenbügelmanipulator	29
Bulbusringe	12

Bulldogklemmen	63
BUNGE Exenterationslöffel	18
BURRATO Lasik Hornhautflap Pinzette	60

C

CARTER Einführer und Halter für Eukleationsplomben	95
CASTROVIEJO Augenschere für die vorderen Synchie	46
CASTROVIEJO Fadenpinzetten	56
CASTROVIEJO Hornhautschere	39
CASTROVIEJO Iridektomieschere	43
CASTROVIEJO Keratomieschere	38
CASTROVIEJO Lanzenmesser	16
CASTROVIEJO Lidsperrerr	7
CASTROVIEJO Mikro-Nadelhalter	65
CASTROVIEJO Nadelhalter	69
CASTROVIEJO Nahtpinzetten	58
CASTROVIEJO Rasierklingshalter und -brecher	72
CASTROVIEJO Tränenkanalsonden	84
CASTROVIEJO Zirkel	92
CASTROVIEJO Zügelnahtpinzette	59
CASTROVIEJO Zyklodialysenspatel	20
CASTROVIEJO-BARRAQUER Zyklodialysenspatel	20
CASTROVIEJO-MICRO Mikro-Nadelhalter	65
CASTROVIEJO-TROUTMAN Hornhautschere	39
CAUER Chalazionspinzette	50
Chalazionlöffel	18
Chalazionmesser	16
Chalazionspinzetten	50
CHAYET Hornhautmarkeur Lasik	89
Chirurgische Pinzette	52
Chirurgische Schere, fein	44
Chirurgische, feine Pinzetten	51
Cilien- und Fremdkörperpinzetten	57
Cilienpinzetten	57
CITELLI Knochenstanzen	91
CLAYMAN Explantationspinzette	61
Clear-Cornea-Incision, Diamantmesser	13
COLIBRI (TROUTMAN) Fixierpinzette	52
COOK Lidsperrerr	5
CRANZ Augenbrause	78
Cystotom	17

D

D.-D.-KOCH Phakospatel	20
DARDENNE Fadenpinzette	56
DARDENNE Irishäkchen	29
DARDENNE Nukleuspinzette	55
DARDENNE Satomesser	16
Descement's Membranstanze	90
DESMARRES Chalazionspinzetten	50
DESMARRES Lidhalter	10
Diamantmesser	13-14
Diamantmesser, Clear-Cornea-Incision	13
Diamantmesser, Keratotomie	14
Diamantmesser, Klängen	13
Diamantmesser, Lid und Dupuytren Klinge	13
Diamantmesser, Messlehre für	14
Diamantmesser, Parazentese	13
Diamantmesser, Spatelmesser	13
Diamantmesser, Tri-facet Klinge	13
DIEFFENBACH Bulldogklemmen	63
Dissektion, Hydro-	77
Diszisionsmesser	17
Diszisionsnadeln	17
DIX Nadel und Flachmeißel	33
DIX Nadel und Hohlmeißel	33
DODEN Implantationspinzette	60
DODICK-LUNTZ Glaukomstanze	90
DRAEGER Bindehautpinzette	54
Drahtschlinge	95
DRYSDALE TITAN LINE Nukleus-Manipulator	27

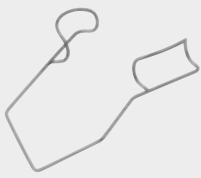

Inhaltsverzeichnis

E

Einführer für Skleranagel	95
Einführer und Halter für Eukleationsplomben	95
Elevatorium	94
ELLIOT Trephinen	82
ELLIS Fremdkörpermeißel	32
ELSCHNIG Irisspatel	19
ELSCHNIG Spatel	20
ELSCHNIG Zügelnahtpinzetten	59
ENGELKING-HESS Irispinzette	62
ENGELS Messspatel	92
Eukleationslöffel	22
Eukleationsplomben, Einführer und Halter für	95
Eukleationsscheren	40
Enzymkanüle	74
Erweiterungsmesser für IOL	15
ESSEN Wundspatel	21
Exenterationslöffel	18
Explantationspinzette	61

F

Fadenklemme	64
Fadenlöspinzette	56
Fadenpinzetten	56
Fadenscheren	40
Faltpinzetten	61
Fasspinzetten	61
FECHNER Implantationspinzette	60
Feine anatomische Pinzetten	51
Feine Arterienklemmen	64
Feine chirurgische Pinzetten	51
Feine chirurgische Scheren	44
FINK Markierungsinstrument	88
Fixierkrallen	53
Fixierpinzetten	52-53
Fixierringe	12
Flachmeißel	94
Flachmeißel und Nadeln	33
FÖRSTER Bindehautpinzette	54
Fragmentpinzetten	55
FRANCESCHETTI KeratoplastikTrephinen	83
FRANKFURT IOL Positionshäkchen	28
FRANKFURT Irishäkchen	29
FRANKFURT Irisspatel	19
FRANKFURT Luftkanüle	77
FRANKFURT-BARRAQUER Lidsperrer	2
Fremdkörper- und Cilienpinzetten	57
Fremdkörperhohlmeißel	32
Fremdkörperinstrumente	32-33
Fremdkörpermeißel	32
Fremdkörpernadel	32
FRIEDMAN-LUER Hohlmeißelzangen	95
FRONIMPOULUS Markierungsinstrument	88

G

GASKIN Fragmentpinzetten	55
GASS Glaukomstanze	90
GIESSEN Lidhalter	10
GIESSEN Tränenkanalsonde	84
GIESSEN Wundspatel	21
GIRARD-SWAN Irismesser	17
Glaskörperscheren	46
Glaukomstanze	90
GOLDSTEIN Wundspreizer	11
Goniotomiemesser	17
GRADLE Cilienpinzette	57
GRAEFE (KAUFMANN) Bindehautpinzette	54
GRAEFE Augenschere	45
GRAEFE Chirurgische Pinzette	52
GRAEFE Cystotom	17
GRAEFE Fixierpinzette	53
GRAEFE Irismesser	17

GRAEFE Schielhaken	30
GRAEFE Sklerotom	17
GRIESHABER-JAEGER Lanzenmesser	16
Griff, Skalpell-	15
GUTHRIE Hauthäkchen	11
GUTHRIE Irishäkchen	11
GUYTON-LUNDSGAARD Sklerotom	17

H

H.-R.-KOCH Absaugkanülen	80
H.-R.-KOCH Drahtschlinge	95
HAAB Irismesser	17
Häkchen, Haut-	11
Häkchen, Iris-	11, 27, 29
Häkchen, Markier-	88
Häkchen, Positions-, IOL	28
Häkchen, Positions-, IOL, TITAN LINE	28
Haken, Muskel-	30
Haken, Schiel-	30
Haken, Wund-	11
HALSTED-MICRO Feine Arterienklemmen	64
Halter für Saugkeile	71
HAMBURG Irispinzette	62
HAMBURG KeratoplastikTrephinen	83
HAMBURG MOD. Luftlanze	16
HAMBURG Orbitalspatel	21
HAMBURG Retrogradsonden	86
HAMBURG Schielhaken	30
Hammer	94
Handgriff, Saugkanülen-, TITAN LINE	80
Handgriffe, Saugkanülen-	80
HARMON-BISHOP Irispinzetten	62
HARMS Trabekularsonden	86
HARTMANN Arterienklemmen	64
HARTMANN Nasenspekula	95
Hauthäkchen	11
Healonkanüle	74
HEBRA Chalazionlöffel	18
HEIDELBERG Fixierpinzette	53
HEIDELBERG Irispinzette	62
HEIDELBERG Nadelhalter	70
HEIMANN Einführer und Halter für Eukleationsplomben	95
HEIMANN Glaskörperscheren	46
HEIMANN Skleranagel	95
HELVESTON Muskelhaken	30
HENRY Cilienpinzette	57
HESS-ENGELKING Irispinzette	62
HIRSCHMANN Spatel	22
HOFFER Hornhautmarkierer	88
Hohlmeißel	94
Hohlmeißel und Nadeln	33
Hohlmeißel, Fremdkörper-	32
Hohlmeißelzangen	95
HOPKINS-JOHN'S Bulldogklemmen	63
Hornhautflap Lasik Pinzetten	60
Hornhautmarkeur Lasik	89
Hornhautmarkierer	88-89
Hornhaut-Oberflächenreiniger-Lasik	18
Hornhautprotektor-Lasik	18
Hornhautschaber	15
Hornhautscheren	39
HOSPITAL-WILLS Kauter	87
Hydrodissektion	77

I

Implantationspinzetten	60
Inzisions-Messzirkel	92
IOL Positionshäkchen	28
IOL Positionshäkchen, TITAN LINE	28
Iridektomiescheren	42-43
Irishäkchen	11, 27, 29
Irismesser	17
Irispinzetten	62-63

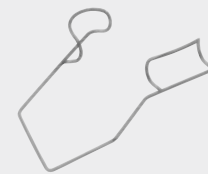

Irispinzetten, fein gerieft	63
Irisspatel	19
Irisspatel, TITAN LINE	19

J

JACOBI IOL Positionshäkchen	28
JACOBI Irishäkchen	29
JACOBI Mikro-Nadelhalter	67
JAEGER Lidplatte	10
JAEGER-GRIESHABER Lanzenmesser	16
JAMESON Schielhaken	30
JESS Fixierpinzette	52
JOHNS-HOPKINS Bulldogklemmen	63
JÜNEMANN Tränenkanalsonden	84

K

KALT Nadelhalter	69
KAMANN Lidsperrerr	8
Kanüle, Enzym-	74
Kanüle, Healon-	74
Kanüle, Saug-	74
Kanüle, Spülschlingen-	78
Kanüle, Spülzystem-	74
Kanüle, Vorderkammer-	79
Kanülen, Absaug-	80
Kanülen, Augen-	74-75
Kanülen, Kapselpolier-	73, 75
Kanülen, Luft-	77
Kanülen, Retrobulbär	73
Kanülen, Saug-, Handgriff, TITAN LINE	80
Kanülen, Saug-, Handgriffe	80
Kanülen, Spül-	78-79
Kanülen, Spül- und Saug-	80
Kanülen, Tränenweg-	75-76
Kanülen, Tränenwegsonden-	74
Kapselpinzetten	49
Kapselpolier-Kanülen	73, 75
Kapselpolierküretten	27
Kapselzängchen	49
Kapsulorhexispinzetten	49
KATZIN Keratoplastikscheren	38
KAUFMANN (GRAEFE) Bindehautpinzette	54
Kauter	87
KELLNAR Retrogradsonden	86
KELLY Descement's Membranstanze	90
KELMAN-MC PHERSON Fragmentpinzette	55
Keratomescheren	38
Keratoplastikmesser	15
Keratoplastikpinzette	52
Keratoplastikscheren	38
Keratoplastik-Siebpatel	22
Keratoplastik-Trephinen	82-83
Keratoplastik-Trephinen, Mikro-	83
Keratotomie, Diamantmesser für	14
Kernspalter	27
KERRISON Knochenstanzen	91
KERSHNER Lidsperrerr	7
KIRBY Kapsulorhexispinzetten	49
Klemme, Faden-	64
Klemmen, Arterien-	64
Klemmen, Arterien-, fein	64
Klemmen, Bulldog-	63
Klemmen, Tuch-	64
Klingen	72
Klingen, Diamantmesser	13
Klingen, Skalpell-	15
KNAPP Diszisionsmesser	17
Knochenstanzen	91
KNOLLE-SHEPARD Implantationspinzette	60
KOCH Faltpinzetten	61
KOCH Kapselzängchen	49
KOCH Lidsperrerr	2
KOCH-D.-D. Phakospatel	20

KOCH-H.-R. Absaugkanülen	80
KOCH-H.-R. Drahtschlinge	95
Kolibripinzetten	54
Kolibripinzetten, Mikro-	54
KRATZ Kapselpolier-Kanülen	73
KRATZ-BARRAQUER-OOSTERHUIS Lidsperrerr	3
KREFELD (LESTER) Bindehautpinzette	54
KREISSIG Lokalisator	31
KREMER Fixierpinzette	52
KROLL-MORRIS Membran-Peeler	31
KUHNT Hornhautschaber	15
Küretten, Kapselpolier-	27

L

LAMBERT Chalazionspinzette	50
Lanze, Luft-	16
Lanzen	16
Lanzen, Phako-	16
Lanzenmesser	16
LAQUA Lokalisatoren	31
Lasik Hornhautflap Pinzetten	60
Lasik Hornhautmarker	89
Lasik Instrumente	18
Lasik-Hornhaut-Oberflächenreiniger	18
Lasik-Hornhautprotektor	18
LEMPERT Raspatorium	94
LESTER (KREFELD) Bindehautpinzette	54
LESTER TITAN LINE Linsenbügelmanipulator	29
LEYDHECKER Zügelnahtpinzette	59
Lid und Dupuytren Klinge, Diamantmesser	13
Lidhalter	10
Lidplatte	10
Lidsperrerr	2-9
LIEBERMANN-TENNANT Lidsperrerr	7-8
LINDSTROM Hornhautmarker	89
Linsenbügelmanipulator	29
Linsenbügelmanipulator TITAN LINE	29
Linsenkerntrotierer	22
Linsenkerntrotierer TITAN LINE	22
Löffel, Chalazion-	18
Löffel, E nukleations-	22
Löffel, Exenterations-	18
Lokalisatoren	31
LORDAN Chalazionspinzette	50
LUCKE Membran-Spatel	24
LUER-FRIEDMAN Hohlmeißelzangen	95
Luftkanülen	77
Luftlanze	16
LUND Irishäkchen	29
LUNDGAARD-GUYTON Sklerotom	17
LUNTZ-DODICK Glaukomstanze	90

M

MACKENSEN Trabekularsonden	86
MAINZ IOL Positionshäkchen	28
MAINZ NEW MODEL TITAN LINE IOL Positionshäkchen	28
MALBRAN Schielhaken	30
Manipulator-Nukleus	27
Manipulator-Nukleus, TITAN LINE	27
Markeur, Hornhaut-, Lasik	89
Markeur, Nahtplatzierung	89
Markierer, Hornhaut-	88-89
Markierer, Naht-	88
Markierhäkchen	88
Markierungsinstrumente	88-89
MASKET Kapsulorhexispinzette	49
Maßstäbe-Stahl	92
MAUMENEE-PARK Lidsperrerr	8
MC PHERSON Fadenpinzette	56
MC PHERSON-KELMAN Fragmentpinzette	55
MC PHERSON-WESTCOTT Sehnenscherer	38
MCINTYRE Vorderkammerkanüle	79

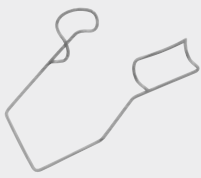

Inhaltsverzeichnis

MEAD Hammer	94
Meißel, Fremdkörper-	32
MELLINGER Lidsperrer	6
MELLINGER-BEARD Lidsperrer	6
Membran-Peeler	31, 47-48
Membran-Spatel	23-24
Membran-Spatelmesser	25
Membranstanze, Descement's	90
MENEZ Hornhautmarkeur Lasik	89
MENEZ Grad Messinstrument	92
Messer, Augen-	15-17
Messer, Chalazion-	16
Messer, Diamant-	13-14
Messer, Diszisions-	17
Messer, Erweiterungs- für IOL	15
Messer, Goniotomie-	17
Messer, Iris-	17
Messer, Keratoplastik-	15
Messer, Lanzen-	16
Messer, Retina-	14
Messer, Sato-	16
Messer, Sklera-	15
Messer, Spatel-	13
Messer, Spatel-, Membran	25
Messinstrumente	92
Messlehre für Diamantmesser	14
Messspatel	92
Messzirkel, Inzisions-	92
METZENBAUM Strabismusscheren	41
MEYER-SCHWICKERATH Lokalisator	31
MEYHÖFER Chalazionlöffel	18
MICRO-CASTROVIEJO Mikro-Nadelhalter	65
MICRO-HALSTED Feine Arterienklemmen	64
Mikro-KeratoplastikTrepshin	83
Mikro-Kolibripinzetten	54
Mikro-Nadelhalter	65-68
Mikro-Scheren mit flachen Federgriffen	34-37
MIYOSHI Nukleusspalter	26
MIYOSHI TITAN LINE Nukleusspalter	26
MOD. HAMBURG Luftlanze	16
MOD.TÜBINGEN-VANNAS Mikro-Scheren	34
MORRIS-KROLL Membran-Peeler	31
MÜLLER Spülkanülen	78
MÜLLER Wundspreizer	11
MUMM-SCHMIDT Röhren-Trepshin	82
MURDOCK Lidsperrer	5
Muskelhaken	30
Muskelpinzetten	59

N

Nadel, Fremdkörper-	32
Nadel, Star-	17
Nadelhalter	69-70
Nadelhalter-Mikro	65-68
Nadeln und Flachmeißel	33
Nadeln und Hohlmeißel	33
Nadeln, Diszisions-	17
NAGAHARA Nukleusspalter	26
Nagel, Sklera-	95
Nahtmarkierer	88
Nahtpinzetten	54, 58
Nahtplatzierungsmarkeur	89
Nasenspekula	95
NEUHANN Faltpinzette	61
NEUHANN Hornhautmarkierer	88
NEUHANN Implantationspinzette	60
NEUHANN Irishäkchen und Kernspalter	27
NEUHANN Kernspalter und Irishäkchen	27
NEUHANN Kernspalter und Spatel	27
NEUHANN Lidsperrer	3
NEUHANN Linsenkernrotierer und Nukleusspalter	22
NEUHANN Nahtmarkierer	88
NEUHANN Nukleusspalter	26
NEUHANN Spatel und Kernspalter	27
NEUHANN TITAN LINE Linsenkernrotierer	22

NOYES Iridektomiescheren	43
NUGENT Lasik Hornhautflap Pinzette	60
Nukleus-Manipulator	27
Nukleus-Manipulator, TITAN LINE	27
Nukleuspinzetten	55
Nukleusspalter	22, 26
Nukleusspalter, TITAN LINE	26

O

OOSTERHUIS-BARRAQUER Lidsperrer	3
OOSTERHUIS-BARRAQUER-KRATZ Lidsperrer	3
Orbitalspatel	21
OSHER Inzisions-Messzirkel	92

P

Parazentese, Diamantmesser für	13
PARK-MAUMENEE Lidsperrer	8
PAUFIQUE Fadenpinzetten	56
PAUFIQUE Keratoplastikmesser	15
Phako-Lanzen	16
Phakospatel	20
PIC SUBRETINAL Membran-Spatel	23
Pinzette, Bandspreiz-	55
Pinzette, chirurgisch	52
Pinzette, Explantations-	61
Pinzette, Fadenlös-	56
Pinzette, Keratoplastik-	52
Pinzette, Ptosis-	50
Pinzette, Vorderkammer-	49
Pinzetten, Bindehaut-	54
Pinzetten, Chalazions-	50
Pinzetten, Cilien-	57
Pinzetten, Cilien- und Fremdkörper-	57
Pinzetten, Faden-	56
Pinzetten, Fall-	61
Pinzetten, Fass-	61
Pinzetten, Feine anatomische	51
Pinzetten, Feine chirurgische	51
Pinzetten, Fixier-	52-53
Pinzetten, Fragment-	55
Pinzetten, Fremdkörper- und Cilien-	57
Pinzetten, Implantations-	60
Pinzetten, Iris-	62-63
Pinzetten, Iris-, fein gerieft	63
Pinzetten, Kapsel-	49
Pinzetten, Kapsulorhexis-	49
Pinzetten, Kolibri-	54
Pinzetten, Lasik Hornhautflap	60
Pinzetten, Mikro-Kolibri-	54
Pinzetten, Muskel-	59
Pinzetten, Naht-	54, 58
Pinzetten, Nukleus-	55
Pinzetten, Vorlagerungs-	59
Pinzetten, Zügelnaht-	59
Positionshäkchen, IOL	28
Positionshäkchen, IOL, TITAN LINE	28
PRETORI Lidsperrer	6
Ptosispinzette	50

R

Rasierklingen	72
Rasierklingenhalter und -brecher	72
Raspatorium	94
REMKY Keratoplastikpinzette	52
REMKY Zügelnahtpinzette	59
RENTSCH Kapselpolierküretten	27
RENTSCH Spülkanüle	79
RENTSCH TITAN LINE IOL Positionshäkchen	28
Retinamesser	14
Retrobulbare Kanülen	73
Retrogradsonden	86

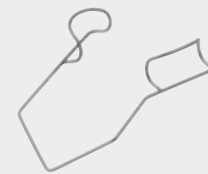

Röhren-Trephinen	82
ROHRSCHEIDER Nadelhalter	70
ROLLET Wundhaken	11

S

Satomesser	16
SATTLER Muskelpinzetten	59
SAUER Irispinzette	62
SAUER Lidsperrer	4
Saugkanüle	74
Saugkanülen, Spül-	80
Saugkanülenhandgriff, TITAN LINE	80
Saugkanülenhandgriffe	80
Saugkeile	71
Saugkeile, Halter für	71
SAUPE Cilienpinzette	57
SAUTTER Luftkanüle	77
SAUTTER Orbitalspatel	21
Schaber, Hornhaut-	15
SCHÄDEL Tucklemme	64
Schere, Sehnen-	38, 44
Scheren für die vorderen Synechien	46
Scheren, Augen-	45-46
Scheren, chirurgische, fein	44
Scheren, Enukleations-	40
Scheren, Faden-	40
Scheren, Glaskörper-	46
Scheren, Hornhaut-	39
Scheren, Iridektomie-	42-43
Scheren, Keratome-	38
Scheren, Keratoplastik-	38
Scheren, Mikro mit flachen Federgriffen	34-37
Scheren, Strabismus-	41
Scheren, Trabekular-	46
Schielhaken	30
SCHIOETZ Tonometer	92
SCHMIDT-MUMM Röhren-Trephinen	82
SCHOTT Lidsperrer	9
SCHWARTZ Fadenklemme	64
SCHWEIZ Irispinzette	62
SCHWEIZER MODELL Keratoplastik-Trephinen	82
SCHWICKERATH-MEYER Lokalisator	31
SEBILEAU Elevatorium	94
Sehnenschere	38, 44
SHAAF Cilien- und Fremdkörperpinzette	57
SHEPARD Implantationspinzette	60
SHEPARD-KNOLLE Implantationspinzette	60
SICHEL Irismesser	17
Siebspatel, Keratoplastik-	22
Silikonball	81
SIMCOE Spül-Saugkanülen	80
SINSKEY Markierhäkchen	88
SINSKEY TITAN LINE IOL Positionshäkchen	28
Skalpellgriff	15
Skalpellklingen	15
Skleranagel	15
Skleranagel	95
Skleranagel, Einführer für	95
Sklerastanze	90
Sklerotome	17
SNELLEN Starschlingen	25
Sonden	86
Sonden, Retrograd-	86
Sonden, Trabekular-	86
Sonden, Tränenkanal-	84-85
SPALECK Faltpinzetten	61
Spatel	20-22, 27
Spatel, Iris-	19
Spatel, Iris-, TITAN LINE	19
Spatel, Keratoplastik-Sieb-	22
Spatel, Mess-	92
Spatel, Orbital-	21
Spatel, Phako-	20
Spatel, Wund-	21
Spatel, Zyklodialysen-	20

Spatel-Membran	23-24
Spatelmesser, Diamantmesser	13
Spatelmesser, Membran-	25
Spekula, Nasen	95
SPENCER Fadenscheren	40
Spreizer, Wund-, selbsthaltend	11
Spül- und Saugkanülen	80
Spülkanülen	78-79
Spülschlingenkanüle	78
Spülzystotomkanüle	74
ST. MARTIN Nahtpinzette	58
Stahl-Maßstäbe	92
Stanze, Gaukom-	90
Stanze, Membran, Descement's	90
Stanze, Sklera-	90
Stanzen	90
Stanzen, Knochen-	91
Starnadel	17
Starschlingen	25
Sterilisierbehälter	93
Sterilisiergestelle	81
STEVENS Bindehautpinzette	54
STEVENS Sehnenscheren	44
Strabismusscheren	41
SUBRETINAL PIC Membran-Spatel	23
SUZUKI IOL Positionshäkchen	28
SWAN-GIRARD Irismesser	17
Synechien, Scheren für die vorderen	46

T

TAKEDA Lidsperrer	2
TENNANT Fadenpinzette	56
TENNANT-LIEBERMANN Lidsperrer	7-8
TENNER Implantationspinzette	60
THORNTON Fixierringe	12
THORNTON Lidsperrer	2
TITAN LINE BRAUWEILER Saugkanülenhandgriff	80
TITAN LINE BREMEN Linsenbügelmanipulator	29
TITAN LINE DRYSDALE Nukleus-Manipulator	27
TITAN LINE IOL Positionshäkchen	28
TITAN LINE Irisspatel	19
TITAN LINE LESTER Linsenbügelmanipulator	29
TITAN LINE Linsenbügelmanipulator	29
TITAN LINE Linsenkerntrotierer	22
TITAN LINE MAINZ NEW MODEL IOL Positionshäkchen	28
TITAN LINE MIYOSHI Nukleusspalter	26
TITAN LINE NEUHANN Linsenkerntrotierer	22
TITAN LINE Nukleus-Manipulator	27
TITAN LINE Nukleusspalter	26
TITAN LINE RENTSCH IOL Positionshäkchen	28
TITAN LINE Saugkanülenhandgriff	80
TITAN LINE SINSKEY IOL Positionshäkchen	28
TITAN LINE WECKER Irisspatel	19
TODD-WADSWORTH Kauter	87
Tonometer	92
Trabekularscheren	46
Trabekularsonden	86
Tränenkanalsonden	84-85
Tränenwegkanülen	75-76
Tränenwegs sondenkanülen	74
Trepane	82-83
Trephinen, Keratoplastik-	82-83
Trephinen, Mikro-Keratoplastik-	83
Trephinen-Röhren	82
Tri-facet Klinge, Diamantmesser	13
TROUTMAN (COLIBRI) Fixierpinzette	52
TROUTMAN Hornhautscheren	39
TROUTMAN Nahtpinzette	54
TROUTMAN Rasierklingenhalter und -brecher	72
TROUTMAN Zügelnahtpinzette	59
TROUTMAN-BARRAQUER Mikro-Nadelhalter	67
TROUTMAN-CASTROVIEJO Hornhautscheren	39
TÜBINGEN Fadenpinzette	56
TÜBINGEN Luftkanüle	77
Tuchklemmen	64

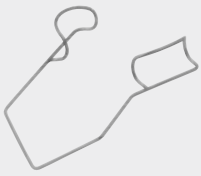

Inhaltsverzeichnis

V

VANNAS Mikro-Scheren	34
VANNAS-MOD.TÜBINGEN Mikro-Scheren	34
Vitrektomie-Zängchen	47-48
VOELCKER Nukleusspalter	26
VON BARSEWISCH Vorderkammerpinzette	49
Vorderkammerkanüle	79
Vorderkammerpinzette	49
Vorlagerungspinzetten	59

W

WADDSWORTH-TODD Kauter	87
WALSER Nahtpinzetten	58
WALSER Sklerastanze	90
WALTER Bulbusringe	12
WALTER Sehnenscherer	44
WATZKE Bandspreizpinzette	55
WEBER Starschlingen	25
WECKER Iridektomiescheren	42
WECKER TITAN LINE Irisspatel	19
WEISS Lidsperrer	4
WELLS E nukleationslöffel	22
WEST Flachmeißel	94
WEST Hohlmeißel	94
WESTCOTT Mikro-Scheren	35
WESTCOTT-MC PHERSON Sehnenscherer	38
WILDER Tränenkanalsonden	84
WILLS-HOSPITAL Kauter	87
Wundhaken	11
Wundspatel	21
Wundspeizer, selbsthaltend	11

Z

Zängchen, Kapsel-	49
Zängchen-Vitrektomie	47-48
Zangen, Hohlmeißel-	95
Zirkel	92
ZIRM Lasik-Hornhaut-Oberflächenreiniger	18
ZIRM Lasik-Hornhautprotektor	18
ZIRM Linsenbügelmanipulator	29
ZIRM Nukleusspalter	26
Zubehör	81
Zügelnahtpinzetten	59
ZÜRICH Nahtpinzetten	54
Zweiwegehahn	81
Zyklodialysenspatel	20

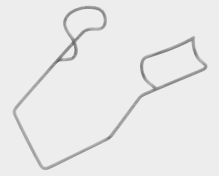

A

Absorbent Strips	71
Absorbent Strips, Holders for	71
Air Injection Cannulae	77
AMON Phaco Spatula	20
AMSLER Capsule Polishing Cannula	75
ANEL Lacrimal Cannulae	76
ANIS Suture Placement Marker	89
Anterior Chamber Cannula	79
Anterior Chamber Forceps	49
Anterior Chamber Synechia Scissors	46
ARLT Cataract Loop	25
ARRUGA Capsule Forceps	49
ARRUGA Needle Holders	69
Aspiration and Irrigation Cannulae	80
Aspiration Cannula Handpiece, TITAN LINE	80
Aspiration Cannula Handpieces	80
Aspiration Cannulae	74, 80
AXENFELD Chalazion Curettes	18
AXENFELD Needle Holder	70
AXENFELD Retractors	11
AYER Chalazion Forceps	50

B

BACKHAUS Towel Clamp	64
BANGERTER Eye Specula	4
BANGERTER Iris Spatulas	19
BANGERTER Lacrimal Probe Cannulae	74
BANGERTER Muscular Clamp	59
BANGERTER Spatula	21
BARKAN Goniotomy Knife	17
BARRAQUER Cilia Forceps	57
BARRAQUER Eye Specula	2
BARRAQUER Fixation Forceps	53
BARRAQUER Holding Forceps	61
BARRAQUER Iridectomy Scissors	43
BARRAQUER Micro Needle Holders	66, 68
BARRAQUER Razor Blade Holder and Breaker	72
BARRAQUER Suture Removing Forceps	56
BARRAQUER-CASTROVIEJO Cyclodialysis Spatula	20
BARRAQUER-FRANKFURT Eye Specula	2
BARRAQUER-KRATZ Eye Specula	2
BARRAQUER-OOSTERHUIS Eye Specula	3
BARRAQUER-OOSTERHUIS-KRATZ Eye Specula	3
BARRAQUER-TROUTMAN Micro Needle Holders	67
BARSEWISCH VON Anterior Chamber Forceps	49
BEARD-MELLINGER Eye Specula	6
BEER Cilia Forceps	57
BERKE Ptosis Forceps	50
BEST Keratoplasty Trephines	83
BEST Trephines	82
BEYER Bone Punches	91
BINKHORST Irrigation Cannula	79
BINKHORST Spatula	20
BISHOP-HARMON Iris Forceps	62
Blade, Tri-Faced, Diamond Knives	13
Blades	72
Blades, Diamond Knives	13
Blades, Scalpel	15
Bone Punches	91
Bone Rongeurs	95
BONN Iris Forceps	62
BONN Iris Forceps, serrated	63
BONN Iris Hook	29
BONN Irrigation Cannulae	79
BONN Scleral Knives	15
BONN Strabismus Hooks	30
BONN Strabismus Scissors	41
BOWMAN Discission Needles	17
Boxes, Sterilizing	93
BOYNTON Needle Holder	70
BRAUWEILER Aspiration Cannula Handpieces	80
BRAUWEILER IOL-Knives	15
BRAUWEILER Irrigation Cannula	79

BRAUWEILER TITAN LINE Aspiration Cannula Handpiece	80
BREMEN TITAN LINE Lens Loop Manipulator	29
Bulb Rings	12
Bulb, Silicone	81
Bulldog Clamps	63
BUNGE Evisceration Spoon	18
BURRATO Lasik Flap Forceps	60

C

Calipers	92
Cannula, Anterior Chamber	79
Cannula, Aspiration, Handpiece, TITAN LINE	80
Cannula, Aspiration, Handpieces	80
Cannula, Cystotome	74
Cannula, Enzyme	74
Cannula, Healon	74
Cannulae Lacrimal	75-76
Cannulae, Air Injection	77
Cannulae, Aspiration	74, 80
Cannulae, Capsule Polishing	73, 75
Cannulae, Eye	74-75
Cannulae, Irrigating Vectis	78
Cannulae, Irrigation	78-79
Cannulae, Irrigation Aspiration	80
Cannulae, Lacrimal Probe	74
Cannulae, Retrobulbar	73
Capsule Forceps	49
Capsule Polishing Cannulae	73, 75
Capsule Polishing Curettes	27
Capsulorhexis Forceps	49
CARTER Inserter and Support for Enucleation Seals	95
CASTROVIEJO Anterior Chamber Synechia Scissors	46
CASTROVIEJO Calipers	92
CASTROVIEJO Corneal Scissors	38
CASTROVIEJO Corneoscleral Scissors	39
CASTROVIEJO Cyclodialysis Spatula	20
CASTROVIEJO Eye Specula	7
CASTROVIEJO Iridectomy Scissors	43
CASTROVIEJO Keratome	16
CASTROVIEJO Lachrymal Probes	84
CASTROVIEJO Micro Needle Holders	65
CASTROVIEJO Needle Holders	69
CASTROVIEJO Razor Blade Holder and Breaker	72
CASTROVIEJO Superior Rectus Forceps	59
CASTROVIEJO Suture Forceps	58
CASTROVIEJO Tying Forceps	56
CASTROVIEJO-BARRAQUER Cyclodialysis Spatula	20
CASTROVIEJO-MICRO Micro Needle Holders	65
CASTROVIEJO-TROUTMAN Corneoscleral Scissors	39
Cataract Loops	25
Cataract Needle	17
CAUER Chalazion Forceps	50
Cauteries	87
Chalazion Curettes	18
Chalazion Forceps	50
Chalazion Knife	16
CHAYET Corneal Marker for Lasik	89
Chisel	94
Chisel and Needles	33
Chisel, Foreign Body	32
Cilia and Foreign Body Forceps	57
Cilia Forceps	57
CITELLI Bone Punches	91
Clamps, Bulldog	63
Clamps, Towel	64
CLAYMAN Explantation Forceps	61
Clear-Cornea-Incision, Diamond Knives	13
COLIBRI (TROUTMAN) Fixation Forceps	52
Colibri Forceps	54
Colibri Forceps, Micro	54
Conjunctiva Forceps	54
COOK Eye Specula	5
Cornea Protector Lasik	18
Cornea Surface Cleaner Lasik	18
Corneal Markers	88-89

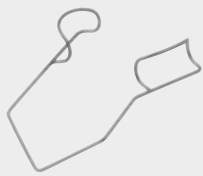

Index

Corneal Markers for Lasik	89
Corneal Scarifiers	15
Corneal Scissors	38
Corneoscleral Punch	90
Corneoscleral Scissors	39
CRANZ Eye Douche	78
Curettes, Capsule Polishing	27
Curettes, Chalazion	18
Cyclodialysis Spatulas	20
Cystotome	17
Cystotome Cannula	74

D

D.-D.-KOCH Phaco Spatula	20
DARDENNE Iris Hook	29
DARDENNE Nucleus Forceps	55
DARDENNE Sato Knife	16
DARDENNE Tying Forceps	56
Degree Gauge	92
Delicate Dissecting Forceps	51
Delicate Haemostatic Forceps	64
Delicate Surgical Scissors	44
Delicate Tissue Forceps	51
Descemet's Membrane Punch	90
DESMARRES Chalazion Forceps	50
DESMARRES Lid Retractors	10
Diamond Knives	13-14
Diamond Knives, Blades	13
Diamond Knives, Clear-Cornea-Incision	13
Diamond Knives, Keratotomy	14
Diamond Knives, Lid and Dupuytren Blade	13
Diamond Knives, Measuring Gauge for	14
Diamond Knives, Paracentesis	13
Diamond Knives, Spatula Knife	13
Diamond Knives, Tri-Faced Blade	13
DIEFFENBACH Bulldog Clamps	63
Dissection Knife	17
Dissection Needles	17
Disscction, Hydro	77
Dissecting Forceps, Delicate	51
DIX Needle and Chisel	33
DIX Needle and Gouge	33
DODEN Implantation Forceps	60
DODICK-LUNTZ Glaucoma Punch	90
Douche Eye	78
DRAEGER Conjunctiva Forceps	54
DRYSDALE TITAN LINE Lens Nucleus Rotator	27
Duct-Trephines	82

E

Elevator	94
ELLIOT Trephines	82
ELLIS Foreign Body Chisel	32
ELSCHNIG Iris Spatulas	19
ELSCHNIG Spatula	20
ELSCHNIG Superior Rectus Forceps	59
ENGELKING-HESS Iris Forceps	62
ENGELS Measuring Spatula	92
Enucleation Scissors	40
Enucleation Seals, Inserter and Support for	95
Enucleation Spoon	22
Enzyme Cannula	74
ESSEN Spatula	21
Ethmoid Keratoplasty Spatula	22
Evisceration Spoon	18
Explantation Forceps	61
Eye Cannulae	74-75
Eye Douche	78
Eye Knives	15-17
Eye Scissors	45-46
Eye Shields	89
Eye Specula	2-9

F

FECHNER Implantation Forceps	60
FINK Marker	88
Fixation Claws	53
Fixation Forceps	52-53
Fixation Rings	12
Flap Lasik Forceps	60
Folders	61
Forceps, Anterior Chamber	49
Forceps, Capsule	49
Forceps, Capsulorhexis	49
Forceps, Chalazion	50
Forceps, Cilia	57
Forceps, Cilia and Foreign Body	57
Forceps, Colibri	54
Forceps, Conjunctiva	54
Forceps, Explantation	61
Forceps, Fixation	52-53
Forceps, Foreign Body and Cilia	57
Forceps, Fragment	55
Forceps, Haemostatic	64
Forceps, Haemostatic, delicate	64
Forceps, Holding	61
Forceps, Implantation	60
Forceps, Iris	62-63
Forceps, Iris, fine serrated	63
Forceps, Keratoplasty	52
Forceps, Lasik Flap	60
Forceps, Micro-Colibri	54
Forceps, Muscle	59
Forceps, Nucleus	55
Forceps, Ptosis-	50
Forceps, Spreading	55
Forceps, Superior Rectus	59
Forceps, Suture	54, 58
Forceps, Suture Removing	56
Forceps, Tissue	52
Forceps, Tying	56
Forceps, Vitrectomy	47-48
Foreign Body and Cilia Forceps	57
Foreign Body Chisel	32
Foreign Body Gouge	32
Foreign Body Instruments	32-33
Foreign Body Needles	32
FÖRSTER Conjunctiva Forceps	54
Fragment Forceps	55
FRANCESCHETTI Keratoplasty Trephines	83
FRANKFURT Air Injection Cannula	77
FRANKFURT IOL Manipulator	28
FRANKFURT Iris Hook	29
FRANKFURT Iris Spatulas	19
FRANKFURT-BARRAQUER Eye Specula	2
FRIEDMAN-LUER Bone Rongeurs	95
FRONIMOPOULUS Marker	88

G

GASKIN Fragment Forceps	55
GASS Glaucoma Punch	90
Gauge Degree	92
GIESSEN Lachrymal Probes	84
GIESSEN Lid Retractor	10
GIESSEN Spatula	21
GIRARD-SWAN Iris Knife	17
Glaucoma Punches	90
GOLDSTEIN Self-Retaining Retractors	11
Goniotomy Knife	17
Gouge	94
Gouge, Foreign Body	32
Gouges and Needles	33
GRADLE Cilia Forceps	57
GRAEFE (KAUFMANN) Conjunctiva Forceps	54
GRAEFE Cystotome	17
GRAEFE Eye Scissors	45
GRAEFE Fixation Forceps	53

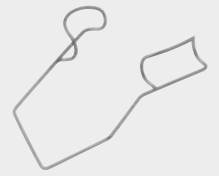

GRAEFE Iris Knife	17
GRAEFE Sclerotome	17
GRAEFE Strabismus Hooks	30
GRAEFE Tissue Forceps	52
GRIESHABER-JAEGER Keratomes	16
GUTHRIE Iris Hook	11
GUTHRIE Skin Retractor	11
GUYTON-LUNDSGAARD Sclerotome	17

H

H.-R.-KOCH Aspiration Cannula	80
H.-R.-KOCH Wire Loop	95
HAAB Iris Knife	17
Haemostatic Forceps	64
Haemostatic Forceps, delicate	64
HALSTED-MICRO Delicate Haemostatic Forceps	64
HAMBURG Iris Forceps	62
HAMBURG Keratoplasty Trephines	83
HAMBURG MOD. Keratome	16
HAMBURG Orbital Spatula	21
HAMBURG Retrograde Probes	86
HAMBURG Strabismus Hook	30
Handle, Scalpel	15
Handpiece, Aspiration Cannula TITAN LINE	80
Handpieces, Aspiration Cannula	80
HARMON-BISHOP Iris Forceps	62
HARMS Trabeculotomy Probes	86
HARTMANN Haemostatic Forceps	64
HARTMANN Nasal Specula	95
Healon Cannula	74
HEBRA Chalazion Curettes	18
HEIDELBERG Fixation Forceps	53
HEIDELBERG Iris Forceps	62
HEIDELBERG Needle Holder	70
HEIMANN Inserter and Support for Enucleation Seals	95
HEIMANN Sclera Pin	95
HEIMANN Vitreous Body Scissors	46
HELVESTON Muscle Hooks	30
HENRY Cilia Forceps	57
HESS-ENGELKING Iris Forceps	62
HIRSCHMANN Spatula	22
HOFFER Corneal Markers	88
Holders for Absorbent Strips	71
Holding Forceps	61
Hook, Marking	88
Hook, Nucleus Dividing	22, 26, 27
Hook, Nucleus Dividing, TITAN LINE	26
Hooks, Iris	11, 27, 29
Hooks, Iris, H-Tip	29
Hooks, Muscle	30
Hooks, Strabismus	30
HOPKINS-JOHNS Bulldog Clamps	63
HOSPITAL-WILLS Cautery	87
H-Tip Iris Hooks	29
Hydrodissection	77

I

Implantation Forceps	60
Incision Measuring Caliper	92
Inserter and Support for Enucleation Seals	95
Inserter for Sclera Pins	95
IOL Knives	15
IOL Manipulators	28
IOL Manipulators, TITAN LINE	28
Iridectomy Scissors	42-43
Iris Forceps	62-63
Iris Forceps, fine serrated	63
Iris Hooks	11, 27, 29
Iris Hooks, H-Tip	29
Iris Knives	17
Iris Spatulas	19
Iris Spatulas, TITAN LINE	19
Irrigating Vectis Cannulae	78

Irrigation and Aspiration Cannulae	80
Irrigation Cannulae	78-79

J

JACOBI IOL Manipulator	28
JACOBI Iris Hook	29
JACOBI Micro Needle Holders	67
JAEGER Lid Plate	10
JAEGER-GRIESHABER Keratomes	16
JAMESON Strabismus Hook	30
JESS Fixation Forceps	52
JOHNS-HOPKINS Bulldog Clamps	63
JÜNEMANN Lachrymal Probes	84

K

KALT Needle Holders	69
KAMANN Eye Specula	8
KATZIN Keratoplasty Scissors	38
KAUFMANN (GRAEFE) Conjunctiva Forceps	54
KELLNAR Retrograde Probes	86
KELLY Descemet's Membrane Punch	90
KELMAN-MC PHERSON Fragment Forceps	55
Keratomes	16
Keratomes-Phaco	16
Keratoplastic Knife	15
Keratoplasty Ethmoid Spatula	22
Keratoplasty Forceps	52
Keratoplasty Scissors	38
Keratoplasty Trephines	82-83
Keratoplasty Trephines, Micro	83
Keratotomy, Diamond Knives for	14
KERRISON Bone Punches	91
KERSHNER Eye Specula	7
KIRBY Capsulorhexis Forceps	49
KNAPP Discission Knife	17
Knife, Chalazion	16
Knife, Discission	17
Knife, Goniotomy	17
Knife, Keratoplastic	15
Knife, Spatula, Diamond Knives	13
Knives, Diamond	13-14
Knives, Diamond for Keratotomy	14
Knives, Diamond for Paracentesis	13
Knives, Diamond, Clear-Cornea-Incision	13
Knives, Diamond, Lid and Dupytren Blade	13
Knives, Diamond, Measuring Gauge for	14
Knives, Eye	15-17
Knives, IOL	15
Knives, Iris	17
Knives, Membrane Spatulas	25
Knives, Retina-	14
Knives, Sato	16
Knives, Scleral	15
KNOLLE-SHEPARD Implantation Forceps	60
KOCH Capsule Forceps	49
KOCH Eye Specula	2
KOCH Folders	61
KOCH-D.-D. Phaco Spatula	20
KOCH-H.-R. Cannula Aspiration	80
KOCH-H.-R. Wire Loop	95
KRATZ Capsule Polishing Cannulae	73
KRATZ-BARRAQUER-OOSTERHUIS Eye Specula	3
KREFELD (LESTER) Conjunctiva Forceps	54
KREISSIG Localizer	31
KREMER Fixation Forceps	52
KROLL-MORRIS Membrane Peeler	31
KUHNT Corneal Scarifiers	15

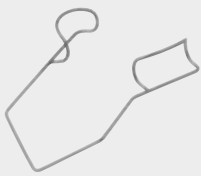

Index

L

Lachrymal Probes	84-85
Lacrimal Cannulae	75-76
Lacrimal Probe Cannulae	74
LAMBERT Chalazion Forceps	50
LAQUA Localizers	31
Lasik Cornea Protector	18
Lasik Cornea Surface Cleaner	18
Lasik Corneal Markers	89
Lasik Flap Forceps	60
Lasik Instruments	18
LEMPERT Raspatory	94
Lens Loop Manipulators	29
Lens Loop Manipulators, TITAN LINE	29
Lens Nucleus Rotator TITAN LINE	22
Lens Nucleus Rotator, TITAN LINE	27
Lens Nucleus Rotators	22, 27
LESTER (KREFELD) Conjunctiva Forceps	54
LESTER TITAN LINE Lens Loop Manipulator	29
LEYDHECKER Superior Rectus Forceps	59
Lid Plate	10
Lid Retractors	10
Lid und Dupuytren Blade, Diamond Knives	13
LIEBERMANN-TENNANT Eye Specula	7-8
LINDSTROM Corneal Marker	89
Localizers	31
Loops, Cataract	25
LORDAN Chalazion Forceps	50
LUCKE Membrane Spatula	24
LUER-FRIEDMAN Bone Rongeurs	95
LUND Iris Hook	29
LUNDSGAARD-GUYTON Sclerotome	17
LUNTZ-DODICK Glaucoma Punch	90

M

MACKENSEN Trabeculotomy Probe	86
MAINZ IOL Manipulator	28
MAINZ NEW MODEL TITAN LINE IOL Manipulators	28
MALBRAN Strabismus Hook	30
Mallet	94
Manipulators, IOL	28
Manipulators, IOL, TITAN LINE	28
Manipulators, Lens Loop	29
Manipulators, Lens Loop, TITAN LINE	29
Marker, Suture	88
Marker, Suture Placement	89
Markers	88-89
Markers, Corneal	88-89
Markers, Corneal for Lasik	89
Marking Hook	88
MASKET Capsulorhexis Forceps	49
MAUMENEE-PARK Eye Specula	8
MC PHERSON Tying Forceps	56
MC PHERSON-KELMAN Fragment Forceps	55
MC PHERSON-WESTCOTT Tenotomy Scissors	38
MCINTYRE Anterior Chamber Cannula	79
MEAD Mallet	94
Measuring Caliper, Incision	92
Measuring Gauge for Diamond Knives	14
Measuring Instruments	92
Measuring Spatula	92
MELLINGER Eye Specula	6
MELLINGER-BEARD Eye Specula	6
Membrane Peelers	31, 47-48
Membrane Punch, Descement's	90
Membrane Spatulas	23-24
Membrane Spatulas Knives	25
MENDEZ Corneal Markers for Lasik	89
MENEDZ Degree Gauge	92
METZENBAUM Strabismus Scissors	41
MEYER-SCHWICKERATH Localizer	31
MEYHÖFER Chalazion Curettes	18
Micro Keratoplasty Trephines	83
Micro Needle Holders	65-68

Micro Scissors with Flat Spring Type Handles	34-37
MICRO-CASTROVIEJO Micro Needle Holders	65
Micro-Colibri Forceps	54
MICRO-HALSTED Delicate Haemostatic Forceps	64
MIYOSHI Nucleus Dividing Hook	26
MIYOSHI TITAN LINE Nucleus Dividing Hook	26
MOD. HAMBURG Keratome	16
MOD.TÜBINGEN-VANNAS Micro Scissors	34
MORRIS-KROLL Membrane Peeler	31
MÜLLER Irrigation Cannulae	78
MÜLLER Self-Retaining Retractors	11
MUMM-SCHMIDT Duct-Trephines	82
MURDOCK Eye Specula	5
Muscle Forceps	59
Muscle Hooks	30

N

NAGAHARA Nucleus Dividing Hook	26
Nasal Specula	95
Needle Holders	69-70
Needle Holders, Micro	65-68
Needle, Cataract	17
Needles and Chisel	33
Needles and Gouges	33
Needles, Discission	17
Needles, Foreign Body	32
NEUHANN Corneal Markers	88
NEUHANN Eye Specula	3
NEUHANN Folder	61
NEUHANN Implantation Forceps	60
NEUHANN Iris Hook and Nucleus Dividing Hook	27
NEUHANN Lens Nucleus Rotator and Nucleus Dividing Hook	22
NEUHANN Nucleus Dividing Hook	26
NEUHANN Nucleus Dividing Hook and Iris Hook	27
NEUHANN Nucleus Dividing Hook and Spatula	27
NEUHANN Spatula and Nucleus Dividing Hook	27
NEUHANN Suture Marker	88
NEUHANN TITAN LINE Lens Nucleus Rotator	22
NOYES Iridectomy Scissors	43
Nucleus Dividing Hook	22, 26, 27
Nucleus Dividing Hook, TITAN LINE	26
Nucleus Forceps	55
Nucleus Lens Rotator TITAN LINE	22
Nucleus Lens Rotator, TITAN LINE	27
Nucleus Lens Rotators	22, 27
NUGENT Lasik Flap Forceps	60

O

OOSTERHUIS-BARRAQUER Eye Specula	3
OOSTERHUIS-BARRAQUER-KRATZ Eye Specula	3
Orbital Spatulas	21
OSHER Incision Measuring Caliper	92

P

Paracentesis, Diamond Knives	13
PARK-MAUMENEE Eye Specula	8
PAUFIQUE Keratoplastic Knife	15
PAUFIQUE Tying Forceps	56
Phaco Spatulas	20
Phaco-Keratomes	16
PIC SUBRETINAL Membrane Spatulas	23
Pin, Sclera	95
PRETORI Eye Specula	6
Probes	86
Probes, Lachrymal	84-85
Probes, Retrograde	86
Probes, Trabeculotomy	86
Ptosis Forceps	50
Punch, Corneoscleral	90
Punch, Membrane, Descement's	90
Punches	90

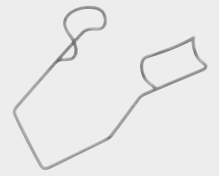

Punches, Bone	91
Punches, Glaucoma	90

R

Racks, Sterilizing	81
Raspatory	94
Razor Blade Holders and Breakers	72
Razor Blades	72
REMKY Keratoplasty Forceps	52
REMKY Superior Rectus Forceps	59
RENTSCH Capsule Polishing Curette	27
RENTSCH Irrigation Cannula	79
RENTSCH TITAN LINE IOL Manipulators	28
Replacements	81
Retinaknives	14
Retractors	11
Retractors, Lid	10
Retractors, Self-Retaining	11
Retractors, Skin	11
Retrobulbar Cannulae	73
Retrograde Probes	86
ROHRSCHEIDER Needle Holder	70
ROLLET Retractor	11
Rongeurs, Bone	95
Rotator, Lens Nucleus, TITAN LINE	27
Rotators, Lens Nucleus	22, 27
Rotators, Lens Nucleus, TITAN LINE	22

S

Sato Knives	16
SATTLER Muscle Forceps	59
SAUER Eye Specula	4
SAUER Iris Forceps	62
SAUPE Cilia Forceps	57
SAUTTER Air Injection Cannula	77
SAUTTER Orbital Spatula	21
Scalpel Blades	15
Scalpel Handle	15
Scarifiers, Corneal	15
SCHÄDEL Towel Clamp	64
SCHIOETZ Tonometer	92
SCHMIDT-MUMM Duct-Trephines	82
SCHOTT Eye Specula	9
SCHWARTZ Serrefine	64
SCHWEIZ Iris Forceps	62
SCHWEIZER MODELL Keratoplasty Trephines	82
SCHWICKERATH-MEYER Localizer	31
Scissors, Anterior Chamber Synechia	46
Scissors, Corneal	38
Scissors, Corneoscleral	39
Scissors, Enucleation	40
Scissors, Eye	45-46
Scissors, Iridectomy	42-43
Scissors, Keratoplasty	38
Scissors, Micro with Flat Spring Type Handles	34-37
Scissors, Stitch	40
Scissors, Strabismus	41
Scissors, Surgical Delicate	44
Scissors, Tenotomy	38, 44
Scissors, Trabeculum	46
Scissors, Vitreous Body	46
Sclera Pin	95
Sclera Pin, Inserter	95
Scleral Knives	15
Sclerotomes	17
SEBILEAU Elevator	94
Self-Retaining Retractors	11
Serrated Iris Forceps	63
Serrefine	64
SHAAF Cilia- and Foreign Body Forceps	57
SHEPARD Implantation Forceps	60
SHEPARD-KNOLLE Implantation Forceps	60
SICHEL Iris Knife	17

Silicone Bulb	81
SIMCOE Irrigation Aspiration Cannulae	80
SINSKEY Marking Hook	88
SINSKEY TITAN LINE IOL Manipulators	28
Skin Retractors	11
SNELLEN Cataract Loop	25
SPALECK Folder	61
Spatual, Measuring	92
Spatula Knife, Diamond Knives	13
Spatula, Keratoplasty Ethmoid	22
Spatulas	20-22, 27
Spatulas Knives, Membrane	25
Spatulas, Cyclodialysis	20
Spatulas, Iris	19
Spatulas, Iris, TITAN LINE	19
Spatulas, Membrane	23-24
Spatulas, Orbital	21
Spatulas, Phaco	20
Specula, Eye	2-9
Specula, Nasal	95
SPENCER Stitch Scissors	40
Spoon, Enucleation	22
Spoon, Evisceration	18
Spreading Forceps	55
ST. MARTIN Suture Forceps	58
Steel rules	92
Sterilizing Boxes	93
Sterilizing racks	81
STEVENS Conjunctiva Forceps	54
STEVENS Tenotomy Scissors	44
Stitch Scissors	40
Stopcock-Two-Way	81
Strabismus Hooks	30
Strabismus Scissors	41
SUBRETINAL PIC Membrane Spatulas	23
Superior Rectus Forceps	59
Surgical Scissors, Delicate	44
Suture Forceps	54, 58
Suture Marker	88
Suture Placement Marker	89
Suture Removing Forceps	56
SUZUKI IOL Manipulator	28
SWAN-GIRARD Iris Knife	17

T

TAKEDA Eye Specula	2
TENNANT Tying Forceps	56
TENNANT-LIEBERMANN Eye Specula	7-8
TENNER Implantation Forceps	60
Tenotomy Scissors	38, 44
THORNTON Eye Specula	2
THORNTON Fixation Rings	12
Tissue Forceps	52
Tissue Forceps, Delicate	51
TITAN LINE Aspiration Cannula Handpiece	80
TITAN LINE BRAUWEILER Aspiration Cannula Handpiece	80
TITAN LINE BREMEN Lens Loop Manipulator	29
TITAN LINE DRYSDALE Lens Nucleus Rotator	27
TITAN LINE IOL Manipulators	28
TITAN LINE Iris Spatulas	19
TITAN LINE Lens Loop Manipulators	29
TITAN LINE Lens Nucleus Rotator	22
TITAN LINE Lens Nucleus Rotator	27
TITAN LINE LESTER Lens Loop Manipulator	29
TITAN LINE MAINZ NEW MODEL IOL Manipulators	28
TITAN LINE MIYOSHI Nucleus Dividing Hook	26
TITAN LINE NEUHANN Lens Nucleus Rotator	22
TITAN LINE Nucleus Dividing Hook	26
TITAN LINE RENTSCH IOL Manipulators	28
TITAN LINE SINSKEY IOL Manipulators	28
TITAN LINE WECKER Iris Spatulas	19
TODD-WADDSWORTH Cautery	87
Tonometer	92
Towel Clamps	64

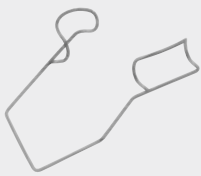

Index

Trabeculotomy Probes	86
Trabeculum Scissors	46
Trephines	82-83
Trephines, Duct	82
Trephines, Keratoplasty	82-83
Trephines, Micro Keratoplasty	83
Tri-Faced Blade, Diamond Knives	13
TROUTMAN (COLIBRI) Fixation Forceps	52
TROUTMAN Corneoscleral Scissors	39
TROUTMAN Razor Blade Holder and Breaker	72
TROUTMAN Superior Rectus Forceps	59
TROUTMAN Suture Forceps	54
TROUTMAN-BARRAQUER Micro Needle Holders	67
TROUTMAN-CASTROVIEJO Corneoscleral Scissors	39
TÜBINGEN Air Injection Cannula	77
TÜBINGEN Tying Forceps	56
Two-Way-Stopcock	81
Tying Forceps	56

V

VANNAS Micro Scissors	34
VANNAS-MOD.TÜBINGEN Micro Scissors	34
Vitreotomy Forceps	47-48
Vitreous Body Scissors	46
VOELCKER Nucleus Dividing Hook	26
VON BARSEWISCH Anterior Chamber Forceps	49

W

WADDSWORTH-TODD Cautery	87
WALSER Corneoscleral Punch	90
WALSER Suture Forceps	58
WALTER Bulb Rings	12
WALTER Tenotomy Scissors	44
WATZKE Spreading Forceps	55
WEBER Cataract Loops	25
WECKER Iridectomy Scissors	42
WECKER TITAN LINE Iris Spatulas	19
WEISS Eye Specula	4
WELLS Enucleation Spoon	22
WEST Chisel	94
WEST Gouge	94
WESTCOTT Micro Scissors	35
WESTCOTT-MC PHERSON Tenotomy Scissors	38
WILDER Lachrymal Probes	84
WILLS-HOSPITAL Cautery	87
Wire Loop	95

Z

ZIRM Lasik Cornea Protector	18
ZIRM Lasik Cornea Surface Cleaner	18
ZIRM Lens Loop Manipulator	29
ZIRM Nucleus Dividing Hook	26
ZÜRICH Suture Forceps	54

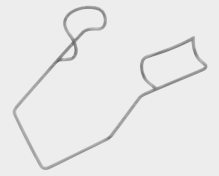

A

Accesorios	81
Afeitar, Hojas de	72
Afeitar, Pinzas para sujetar y romper hojas de	72
Agarre, Pinzas de	61
Aguja para cataracta	17
Agujas para cuerpos extraños	32
Agujas para discisión	17
Agujas y cinceles para cuerpos extraños	33
Agujas y gubias para cuerpos extraños	33
AMON Espátula para phaco	20
ANEL Cánulas para vias lacrimales	76
Anillos de fijación	12
Anillos de fijación para incisión en córnea clara	12
ARLT Asa para catarata	25
ARRUGA Pinzas para cápsula	49
ARRUGA Porta-agujas	69
Asa	95
Asas para catarata	25
Aspiración e irrigación, Cánulas para	80
Aspiración, Cánulas de	74, 80
Atrículos diversos	94 - 95
AXENFELD Cucharilla para chalazión	18
AXENFELD Porta-agujas	70
AXENFELD Separadores	11
AYER Pinza para chalazión	50

B

BACKHAUS Pinza de campo	64
BANGERTER Blefarostato	4
BANGERTER Espátulas	21
BANGERTER Espátulas para iris	19
BANGERTER Pinza muscular	59
BARCAN Cuchillo para goniotomía	17
BARRAQUER (MODELO ORIGINAL) Micro-Porta-agujas	68
BARRAQUER Blefarostatos	2
BARRAQUER Micro-Porta-agujas	66, 68
BARRAQUER Pinza de agarre	61
BARRAQUER Pinza para sujetar y romper hojas de afeitar	72
BARRAQUER Pinza para sutura	56
BARRAQUER Pinzas de fijación	53
BARRAQUER Pinzas para depilar	57
BARRAQUER Tijeras para iridectomía	42, 43
BARRAQUER-CASTROVIEJO Espátula para ciclodíalisis	20
BARRAQUER-FRANKFURT Blefarostato	2
BARRAQUER-KRATZ Blefarostato	2
BARRAQUER-KRATZ OOSTERHUIS Blefarostato	3
BARRAQUER-OOSTERHUIS Blefarostatos	3
BARRAQUER-OOSTERHUIS-KRATZ Blefarostato	3
BARRAQUER-TROUTMAN Micro-Porta-agujas	67
BEARD-MELLINGER Blefarostatos	6
BEER Pinza para depilar	57
BERKE Pinza de ptosis	50
BEST Trépanos	82
BEST Trépanos para queratoplastia	82 - 83
BEYER Pinza para cortar huesos	91
BINKHORST Cánula para irrigación	79
BINKHORST Espátula	20
BISHOP-HARMON Pinzas para iris	62
Bisturi, Mango de	15
Bisturiles esteriles, Hojas de	15
Blefarostatos	2
BONN Cánulas para irrigación	79
BONN Cuchillos para esclera	15
BONN Gancho para iris	29
BONN Ganchos para estrabismo	30
BONN Pinzas de disección para iris	63
BONN Pinzas para iris	62
BONN Tijeras para estrabismo	41
BOWMAN Agujas para discisión	17
BOYNTON Porta-agujas	70
BRAUWEILER Cánula para irrigación	79
BRAUWEILER Cuchillos para ampliación IOL	15
BRAUWEILER Mango para cánulas de aspiración	80

BRAUWEILER Mango para cánulas de aspiración TITAN-LINE	80
BREMEN Gancho para manipular IOL TITAN-LINE	29
Bulldog Clamps	63
BUNGE Cucharillas para exenteración	18
BURRATO Pinza corneales para lasik	60

C

Cajas de esterilización	93
Calibrador para cuchillos de diamante	14
Cámara anterior, Cánula para	79
Cámara anterior, Pinza para la	49
Campo, Pinzas de campo	64
Cánula para cámara anterior	79
Cánula para enzima	74
Cánula para healon	74
Cánula para irrigación de cistotomos	74
Cánulas de asa para irrigación	78
Cánulas de aspiración	74, 80
Cánulas de aspiración, Mangos para	80
Cánulas para aire, hidrodisección	77
Cánulas para irrigación	78 - 79
Cánulas para irrigación y aspiración	80
Cánulas para ojos	74 - 75
Cánulas para pulir la cápsula	73, 75
Cánulas para vias lacrimales	74 - 76
Cánulas retrobulbares	73
Cápsula, Cánulas para pulir la	73, 75
Cápsula, Curetas para pulir la	27
Cápsula, Manipulador del núcleo y pulidor para	27
Cápsula, Pinzas para	49
CARTER Introdutor y sujetador	95
CASTROVIEJO Blefarostatos	7
CASTROVIEJO Compás	92
CASTROVIEJO Cuchillo lanceolar	16
CASTROVIEJO Espátulas para ciclodíalisis	20
CASTROVIEJO Micro-Porta-agujas	65
CASTROVIEJO Pinza para recto superior	59
CASTROVIEJO Pinzas para sujetar y romper hojas de afeitar	72
CASTROVIEJO Pinzas para sutura	56
CASTROVIEJO Pinzas para sutura	58
CASTROVIEJO Porta-agujas	69
CASTROVIEJO Sonda para vias lacrimales	84
CASTROVIEJO Tijera para iridectomía	42, 43
CASTROVIEJO Tijeras para cornea	38 - 39
CASTROVIEJO-BARRAQUER Espátula para ciclodíalisis	20
CASTROVIEJO-MICRO Micro-Porta-agujas	65
CASTROVIEJO-TROUTMAN Tijeras para cornea	39
Catarata, Asas para	25
CAUER Pinza para chalazión	50
Cauterío	87
Chalazión, Cucharillas para	18
Chalazión, Cuchillo para	16
Chalazión, Pinzas para	50
CHAYET Marcadore de córnea	89
Ciclodíalisis, Espátulas para	20
Cinzel	94
Cinceles e agujas para cuerpos extraños	33
Cistotomos, Cánula para irrigación de	74
CITELLI Pinzas para cortar huesos	91
Clamps Bulldog	63
CLAYMAN Pinza de explantación	61
COLIBRI (TROUTMAN) Pinza de fijación	52
Colibrí, Micro-pinzas tipo	54
Colibrí, Pinzas tipo	54
Compás	92
Conjuntiva, Pinzas para	54
COOK Blefarostatos	5
Córnea, Legras para	15
Córnea, Marcadores de	88
Córnea, Tijeras para	38 - 39
Corneal, Lasik limpiador de la superficie	18
Corneal, Lasik protector	18
CRANZ Ducha para ojos	78
Cucharilla para enucleación	22
Cucharillas para chalazión	18

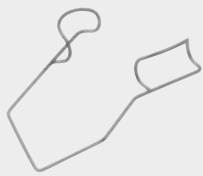

Índice alfabético

Cucharillas para exenteración	18
Cuchillo de diamante para paracentesis	13
Cuchillo de diamante para párpado y dupuytren	13
Cuchillo para chalazión	16
Cuchillo para discisión	17
Cuchillo para goniotomía	17
Cuchillo para queratoplastia	15
Cuchillo-espátula de diamante	13
Cuchillo-espátula para membrana	25
Cuchillos de diamante	13 - 14
Cuchillos de diamante para incisión en córnea clara	13
Cuchillos de diamante para queratoma	14
Cuchillos de diamante para retina	14
Cuchillos de diamante, Calibrador para	14
Cuchillos lanceolares	16
Cuchillos oculares	15 - 17
Cuchillos para ampliación IOL	15
Cuchillos para esclera	15
Cuchillos para iris	17
Cuchillos para sato	16
Cuerpos extraños, Agujas para	32
Cuerpos extraños, Agujas y cinceles para	33
Cuerpos extraños, Cinceles y agujas para	33
Cuerpos extraños, Espátula para	32
Cuerpos extraños, Gubia para	32
Cuerpos extraños, Instrumentos para	32 - 33
Cuerpos extraños, Pinzas para depilar y	57
Curetas para pulir la cápsula	27

D

D.-D.-KOCH Espátula para phaco	20
DARDANNE Cuchillo para sato	16
DARDANNE Pinza para sutura	56
DARDENNE Gancho para iris	29
DARDENNE Pinza para núcleo	55
Depilar, Pinzas para	57
DESMARRES Pinzas para chalazión	50
DESMARRES Separadores de párpado	10
DIEFFENBACH Clamps Bulldog	63
Discisión, Agujas para	17
Discisión, Cuchillo para	17
Dissección, Pinzas finas de	51
Diversos artículos	94 - 95
DIX Aguja y cinceles para cuerpos extraños	33
DIX Aguja y gubia para cuerpos extraños	33
DIX Cinceles y agujas para cuerpos extraños	33
DIX Gubia y agujas para cuerpos extraños	33
DODEN Pinza para implantación	60
DODICK-LUNTZ Pinza saca-bocados	90
DRAEGER Pinza para conjuntiva	54
DRYSDALE Manipulador del núcleo y pulidor para cápsula	27
Ducha para ojos	78
Dupuytren y párpado, Cuchillo de diamante para	13

E

Elevador	94
ELLIOT Trépanos	82
ELLIS Espátula para cuerpos extraños	32
ELSCHING Espátula	20
ELSCHING Espátulas para iris	19
ELSCHING Pinzas para recto superior	59
ENGELKING-HESS Pinza para iris	62
ENGELS Espátula de medición	92
Enucleación, Cucharilla para	22
Enucleación, Tijeras para	40
Enzima, Cánula para	74
Esclera, Cuchillos para	15
Esclera, Introdutor del pin para	95
Esclera, Pin para	95
Escleral, Pinza saca-bocados	90
Esclerótomos	17
Espátula de medición	92
Espátula para cuerpos extraños	32

Espátula para queratoplástica	22
Espátula-cuchillo para membrana	25
Espátulas	20 - 22
Espátulas orbital	21
Espátulas para ciclodíalisis	20
Espátulas para iris	19
Espátulas para membrana	23 - 25
Espátulas para phaco	20
Espéculo nasal	95
ESSEN Espátula	21
Esterilización, Cajas de	93
Estrabismo, Ganchos para	30
Estrabismo, Tijeras para	41
Exenteración, Cucharillas para	18
Explantación, Pinza de	61

F

FECHNER Pinza para implantación	60
Fijación, Ganchos de	53
Fijación, Pinzas de	52 - 53
FINK Marcador	88
FÖRSTER Pinza para conjuntiva	54
Fragmentos, Pinzas para	55
FRANCESCHETTI Trépanos para queratoplastia	82 - 83
FRANFURT Espátulas para iris	19
FRANKFURT Cánula para aire, hidrodisección	77
FRANKFURT Gancho para iris	29
FRANKFURT Gancho para manipular IOL	28
FRANKFURT-BARRAQUER Blefarostato	2
FRIEDMAN-LUER Pinza-gubia	95
FRONIMOPULUS Marcador	88

G

Gancho marcador	88
Gancho para iris y separador del núcleo	27
Ganchos de fijación	53
Ganchos para estrabismo	30
Ganchos para iris	29
Ganchos para iris (ganchos para piel)	11
Ganchos para manipular IOL	28 - 29
Ganchos para manipular IOL TITAN-LINE	28 - 29
Ganchos para músculo	30
Ganchos para piel (ganchos para iris)	11
GASKIN Pinzas para fragmentos	55
GASS Pinza saca-bocados para glaucoma	90
GIESSEN Espátula	21
GIESSEN Separador de párpado	10
GIESSEN Sonda para vías lacrimales	84
GIRARD-SWAN Cuchillo para iris	17
Glaucoma, Pinzas saca-bocados para	90
GOLDSTEIN Separador autostático	11
Goniotomía, Cuchillo para	17
GRADLE Pinza para depilar	57
GRAEFE (KAUFMANN) Pinza para conjuntiva	54
GRAEFE Cuchillo para iris	17
GRAEFE Esclerótomo	17
GRAEFE Ganchos para estrabismo	30
GRAEFE Pinza de fijación	53
GRAEFE Pinza quirúrgica	51 - 52
GRAEFE Quistótomo	17
GRAEFE Tijera ocular	45
GRIESHABER-JAEGER Cuchillos lanceolares	16
Gubia	94
Gubia para cuerpos extraños	32
Gubias y agujas para cuerpos extraños	33
GUTHRIE Ganchos para iris (ganchos para piel)	11
GUTHRIE Ganchos para piel (ganchos para iris)	11
GUYTON-LUNDSGAARD Esclerótomo	17

H

H.-R.-KOCH Asa	95
-----------------------	----

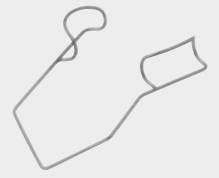

H.-R.-KOCH Cánula para aspiración	80
HAAB Cuchillo para iris	17
HALSTED-MICRO Pinzas hemostáticas	64
HAMBURG Espátula orbital	21
HAMBURG Gancho para estrabismo	30
HAMBURG MOD. Lanceta	16
HAMBURG Pinza para iris	62
HAMBURG Sondas retrógradas	86
HAMBURG Trépanos para queratoplastia	82 - 83
HARMON-BISHOP Pinzas para iris	62
HARMS Sondas trabeculares	86
HARTMANN Espéculo nasal	95
HARTMANN Pinzas hemostáticas	64
Healon, Cánula para	74
HEBRA Cucharillas para chalazión	18
HEIDELBERG Pinza de fijación	53
HEIDELBERG Pinza para iris	62
HEIDELBERG Porta-agujas	70
HEIMANN Pin para esclera	95
HEIMANN Tijeras para vítreo	46
HELVESTON Ganchos para músculo	30
Hemostáticas	64
HENRY Pinza para depilar	57
HESS-ENGELKING Pinza para iris	62
Hidrodissección, Cánulas para aire	77
HIRSCHMANN Espátula	22
HOFFER Marcadores de córnea	88
Hojas de afeitar	72
Hojas de afeitar, Pinzas para sujetar y romper	72
Hojas de bisturíes, estériles	15
HOPKINS-JOHN Clamps Bulldog	63
HOSPITAL-WILLS Cauterío	87

I

Implantación, Pinzas para	60
Incisión en córnea clara, Anillos de fijación	12
Incisión en córnea clara, Cuchillos de diamante para	13
Instrumentos de medición	92
Instrumentos para cuerpos extraños	32 - 33
Instrumentos para lasik	18
Introducción del pin para esclera TITAN-LINE	95
Introducción y sujetador	95
IOL, Cuchillos para ampliación	15
IOL, Ganchos para manipular	28
IOL, TITAN-LINE Ganchos para manipular	28 - 29
IOL's plegables, Pinzas para plegar	61
Iridectomía, Tijeras para	42, 43
Iris, Cuchillos para	17
Iris, Espátulas para iris	19
Iris, Ganchos para	29
Iris, Pinzas para	62
Iris, Pinzas para, estridas finas	63
Iris, Separador del núcleo y gancho para	27
Irrigación y aspiración, Cánulas para	80
Irrigación, Cánulas de asa para	78
Irrigación, Cánulas para	78

J

JACOBI Gancho para iris	29
JACOBI Ganchos para manipular IOL	28
JACOBI Micro-Porta-agujas	67
JAEGER Placa metálica para párpado	10
JAEGER-GRIESHABER Cuchillos lanceolares	16
JAMESON Gancho para estrabismo	30
JESS Pinza de fijación	52
JOHN-HOPKINS Clamps Bulldog	63
JÜNEMANN Sondas para vías lacrimales	84

K

KALT Porta-agujas	69
KAMANN Blefarostato	8

KATZIN Tijeras para queratoplastia	38
KAUFMANN (GRAEFE) Pinza para conjuntiva	54
KELLNAR Sondas retrógradas	86
KELLY Pinza saca-bocados	90
KELMAN-MC PHERSON Pinza para fragmentos	55
KERRISON Pinzas para cortar huesos	91
KERSHNER Blefarostatos	7
KNAPP Cuchillo para discisión	17
KNOLLE-SHEPARD Pinza para implantación PCL	60
KOCH Blefarostato	2
KOCH Pinza para cápsula	49
KOCH Pinza para plegar IOL's plegables	61
KOCH-D.-D. Espátula para phaco	20
KOCH-H.-R. Asa	95
KOCH-H.-R. Cánula para aspiración	80
KRATZ-BARRAQUER-OOSTERHUIS Blefarostato	3
KRATZ-OOSTERHUIS-BARRAQUER Blefarostato	3
KREFELD (LESTER) Pinza para conjuntiva	54
KREISSIG Localizador	31
KREMER Pinza de fijación	52
KROLL-MORRIS Raspador de membrana	31
KUHNT Legras para córnea	15

L

LAMBERT Pinza para chalazión	50
Lanceolares, Cuchillos	16
Lancetas	16
Lancetas-phaco	16
LAQUA Localizadores	31
Lasik limpiador de la superficie corneal	18
Lasik protector corneal	18
Lasik, Instrumentos para	18
Lasik, Pinzas corneales para	60
Lave	81
Legras para córnea	15
LEMBERT Periostotomo	94
Lente, Rotador	22
LESTER (KREFELD) Pinza para conjuntiva	54
LESTER Gancho para manipular IOL TITAN-LINE	29
LEYDHECKER Pinza para recto superior	59
LIEBERMANN-TENNANT Blefarostatos	7 - 8
Ligadura, Pinza para	64
Ligaduras, Pinzas para	54
Ligaduras, Tijeras para	40
LINDSTROM Marcadores de córnea	89
Localizadores	31
LORDAN Pinza para chalazión	50
LUER-FRIEDMAN Pinza-gubia	95
LUND Gancho para iris	29
LUNDSGAARD-GUYTON Esclerótomo	17
LUNTZ-DODICK Pinza saca-bocados	90

M

MACKENSEN Sondas trabeculares	86
MAINZ Gancho para manipular IOL	28
MAINZ NEW MODEL Gancho para manipular IOL TITAN-LINE	28
MALBRAN Gancho para estrabismo	30
Mango de bisturí	15
Mangos para cánulas de aspiración	80
Manipulador del núcleo y pulidor para cápsula	27
Marcador para sutura	88 - 89
Marcador, Gancho	88
Marcadores	88 - 89
Marcadores de córnea	88
Martillo	94
MAUMENEE-PARK Blefarostato	8
MC PHERSON Pinza para sutura	56
MC PHERSON-KELMAN Pinza para fragmentos	55
MC PHERSON-WESTCOTT Tijera para tenotomía	38
MCINTYRE Cánula para cámara anterior	79
MEAD Martillo	94
Medición, Espátula de	92
MELLINGER Blefarostatos	6

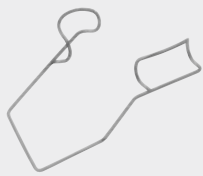

Índice alfabético

MELLINGER-BEARD Blefarostatos	6
Membrana, Espátulas para	23 - 25
Membrana, Raspadores de	31, 47, 48
MENDEZ Calibrador de ángulos	92
MENDEZ Marcadore de córnea	89
METZENBAUM Tijeras para estrabismo	41
MEYER-SCHWICKERATH Localizador	31
MEYHÖFER Cucharillas para chalazión	18
MICRO-CASTROVIEJO Micro-Porta-agujas	65
MICRO-HALSTED Pinzas hemostáticas	64
Micro-pinzas tipo Colibrí	54
Micro-Porta-agujas	65
Micro-tijeras	34 - 37
MIYOSHI Separador del núcleo TITAN-LINE	26
MIYOSHI Separadores del núcleo	26
MOD. HAMBURG Lanceta	16
MOD. TÜBINGEN VANNAS Micro-tijeras	34
MODEL NEW MAINZ Gancho para manipular IOL TITAN-LINE	28
MODELL SCHWEIZER Trépanos para queratoplastia	82
MORRIS-KROLL Raspador de membrana	31
MÜLLER Cánulas para irrigación	78
MÜLLER Separador autostático	11
MUMM-SCHMIDT Trépanos	82
MURDOCK Blefarostatos	5
Musculares, Pinzas	59
Músculo, Gachos para	30

N

NAGAHARA Separador del núcleo	26
NEUHANN Blefarostato	3
NEUHANN Marcador para sutura	88
NEUHANN Marcadores de córnea	88
NEUHANN Pinza para implantación	60
NEUHANN Pinza para plegar IOL's plegables	61
NEUHANN Rotador de lente TITAN-LINE	22
NEUHANN Rotador de lente y separador del núcleo	22
NEUHANN Separador del núcleo y gancho para iris	27
NEUHANN Separadores del núcleo	26
NEW MODEL MAINZ Gancho para manipular IOL TITAN-LINE	28
NOYES Tijeras para iridectomía	42, 43
Núcleo, Gancho para iris y separador del	27
Núcleo, Pulidor para cápsula y manipulador del	27
Núcleo, Separador del	22
Núcleo, Separador del	22, 26
NUGENT Pinza corneales para lasik	60

O

Oculares, Cuchillos	15
Oculares, Tijeras	45
Ojos, Cánulas para	74
Ojos, Ducha para	78
Ojos, Protectores para	89
OOSTERHUIS-BARRAQUER Blefarostatos	3
OOSTERHUIS-BARRAQUER-KRATZ Blefarostato	3
OOSTERHUIS-KRATZ-BARRAQUER Blefarostato	3
Orbital, Espátulas	21
OSHER Compás	92

P

Paracentesis, Cuchillo de diamante para	13
PARK-MAUMENEE Blefarostato	8
Párpado y dupuytren, Cuchillo de diamante para	13
Párpado, Placa para	10
Párpado, Separadores de	10
PAUFIQUE Cuchillo para queratoplastia	15
PAUFIQUE Pinzas para sutura	56
Pera de silicona	81
Periostotomo	94
Phaco, Espátulas para	20
Phaco-lancetas	16
Pin para esclera	95

Pinza de explantación	61
Pinza de ptosis	50
Pinza para dilatar	55
Pinza para la cámara anterior	49
Pinza para ligadura	64
Pinza para queratoplastia	52
Pinza saca-bocados escleral	90
Pinza-gubia	95
Pinzas corneales para lasik	60
Pinzas de agarre	61
Pinzas de campo	64
Pinzas de fijación	52 - 53
Pinzas finas de disección	51
Pinzas finas quirúrgicas	51 - 52
Pinzas hemostáticas	64
Pinzas musculares	59
Pinzas para cápsula	49
Pinzas para chalazión	50
Pinzas para conjuntiva	54
Pinzas para cortar huesos	91
Pinzas para depilar	57
Pinzas para depilar y cuerpos extraños	57
Pinzas para fragmentos	55
Pinzas para implantación	60
Pinzas para iris	62
Pinzas para iris, estriadas finas	63
Pinzas para ligaduras	54
Pinzas para núcleo	55
Pinzas para plegar IOL's plegables	61
Pinzas para recto superior	59
Pinzas para sujetar y romper hojas de afeitar	72
Pinzas para sutura	56, 58
Pinzas para vitrectomía	47 - 48
Pinzas saca-bocados	90
Pinzas saca-bocados para glaucoma	90
Pinzas tipo Colibrí	54
Pinzas-micro tipo Colibrí	54
Placa para párpado	10
Porta para puntas absorbentes	71
Porta-agujas	69 - 70
Porta-agujas-micro	65
Porta-cánulas para esterilización	81
PRETORI Blefarostatos	6
Protectores para ojos	89
Ptosis, Pinza de	50
Pulidor para cápsula y manipulador del núcleo	27
Puntas absorbentes	71
Puntas absorbentes, Porta para	71

Q

Queratomía, cuchillos de diamante para	14
Queratoplastia, Cuchillo para	15
Queratoplastia, Pinza para	52
Queratoplastia, Trépanos para	82 - 83
Queratoplástica, Espátula para	22
Quirúrgicas, Pinzas finas	51 - 52
Quistótomo	17

R

Raspadores de membrana	31, 47, 48
Recto superior, Pinzas para	59
Reglas	92
REMKY Pinza para queratoplastia	52
REMKY Pinza para recto superior	59
RENTSCH Cánula para irrigación	79
RENTSCH Curetas para pulir la cápsula	27
RENTSCH Gancho para manipular IOL TITAN-LINE	28
Retina, Cuchillos de diamante para	14
Retrógradas, Sondas	86
ROHRSCHNEIDER Porta-agujas	70
ROLLET Separador	11
Rotador de lente TITAN-LINE	22

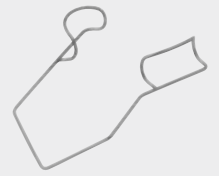

S

Sato, Cuchillos para	16
SATTLER Pinzas musculares	59
SAUER Blefarostato	4
SAUER Pinza para iris	62
SAUPE Pinza para depilar	57
SAUTER Espátulas orbital	21
SAUTTER Cánula para aire, hidrodissección	77
SCHÄDEL Pinza de campo	64
SCHIOETZ Tonómetro	92
SCHMIDT-MUMM Trépanos	82
SCHOTT Blefarostatos	9
SCHWARTZ Pinza para ligadura	64
SCHWEIZ Pinza para iris	62
SCHWEIZER MODELL Trépanos para queratoplastia	82
SEBILEAU Elevador	94
Separador del núcleo TITAN-LINE	26
Separador del núcleo y gancho para iris	27
Separadores	11
Separadores autostáticos	11
Separadores de párpado	10
Separadores del núcleo	22, 26
SHAAF Pinza para depilar y cuerpos extraños	57
SHEPARD Pinzas para implantación	60
SHEPARD-KNOLLE Pinza para implantación	60
SICHEL Cuchillo para iris	17
Silicona, Pera de	81
SIMCOE Cánula para irrigación y aspiración	80
Sinequia anterior, Tijeras para	46
SINSKEY Gancho marcador	88
SINSKEY Gancho para manipular IOL TITAN-LINE	28
SNELLEN Asa para catarata	25
Sondas	86
Sondas para vías lacrimales	84 - 85
Sondas retrógradas	86
Sondas trabeculares	86
SPALECK Pinza para plegar IOL's plegables	61
SPENCER Tijeras para ligaduras	40
ST. MARTIN Pinza para sutura	58
STEVENS Pinza para conjuntiva	54
STEVENST Tijeras para tenotomía	44
Sujetador y Introdutor	95
Sujetar, Pinzas para romper hojas de afeitar y	72
Sutura, Marcador para	88 - 89
Sutura, Pinzas para	56
SUZUKI Gancho para manipular IOL	28
SWAN-GIRARD Cuchillo para iris	17

T

TAKEDA Blefarostato	2
TENNANT Pinza para sutura	56
TENNANT-LIEBERMANN Blefarostatos	7 - 8
TENNER Pinza para implantación	60
Tenotomía, Tijeras para	44
THORNTON Anillos de fijación	12
THORNTON Blefarostato	2
Tijeras finas para cirugía	44
Tijeras oculares	45
Tijeras para cornea	38 - 39
Tijeras para enucleación	40
Tijeras para estrabismo	41
Tijeras para iridectomía	42, 43
Tijeras para ligaduras	40
Tijeras para sinequia anterior	46
Tijeras para tenotomía	44
Tijeras para vítreo	46
Tijeras trabeculares	46
Tijeras-mirco	34 - 37
TITAN-LINE Espátulas para iris	19
TITAN-LINE Ganchos para manipular IOL	28 - 29
TITAN-LINE Introdutor del pin para esclera	95
TITAN-LINE Mango para cánulas de aspiración	80
TITAN-LINE Rotador de lente	22
TITAN-LINE Separador del núcleo	26

TODD-WADDSWORTH Cauterio	87
Tonómetro	92
Trabeculares, Sondas	86
Trabeculares, Tijeras	46
Trépanos	82 - 83
Trépanos para queratoplastia	82 - 83
TROUTMAN (COLIBRI) Pinza de fijación	52
TROUTMAN Pinza para ligaduras	54
TROUTMAN Pinza para recto superior	59
TROUTMAN Pinzas para sujetar y romper hojas de afeitar	72
TROUTMAN Tijeras para cornea	39
TROUTMAN-BARRAQUER Micro-Porta-agujas	67
TROUTMAN-CASTROVIEJO Tijeras para cornea	39
TÜBINGEN Cánula para aire, hidrodissección	77
TÜBINGEN Pinzas para sutura	56

V

VANNAS Micro-tijeras	34
VANNAS MOD. TÜBINGEN Micro-tijeras	34
Vías lacrimales, Cánulas para	74 - 76
Vías lacrimales, Sondas para	84 - 85
Vitrectomía, Pinzas para	47 - 48
Vítreo, Tijeras para	46
VOELCKER Separador del núcleo	26
VON BARSEWISCH Pinza para la cámara anterior	49

W

WADDSWORTH-TODD Cauterio	87
WALSER Pinza saca-bocados escleral	90
WALSER Pinzas para sutura	58
WALTER Anillos para bulbo	12
WALTER Tijera para tenotomía	44
WATZKE Pinza para dilatar	55
WEBER Asas para catarata	25
WECKER Espátulas para iris TITAN-LINE	19
WECKER Tijeras para iridectomía	42, 43
WEISS Blefarostato	4
WELLS Cucharilla para enucleación	22
WEST Cíncel	94
WEST Gubia	94
WESTCOTT Micro-tijeras	35
WESTCOTT-MC PHERSON Tijera para tenotomía	38
WILDER Sondas para vías lacrimales	84
WILLS-HOSPITAL Cauterio	87

Z

ZIRM Gancho para manipular IOL	29
ZIRM Lasik protector corneal	18
ZIRM Lasik-limpiador de la superficie corneal	18
ZIRM Separador del núcleo	26
ZÜRICH Pinzas para ligaduras	54



Índice alfabético

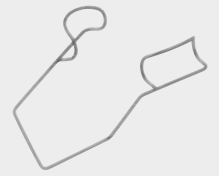

A

Accessoires	81
Aiguille à cataracte	17
Aiguilles à corps étrangers	32
Aiguilles à discision	17
Aiguilles et ciseaux-burins à corps étrangers	33
Aiguilles et gouges à corps étrangers	33
AMON Spatule pour phaco	20
ANEL Canules à voix lacrymales	76
Anneaux de fixation	12
Anneaux de fixation pour Clear-Cornea-Incision	12
Anse	95
Anses à cataracte	25
Anses à lentilles avec irrigation	78
ARLT Anse à cataracte	25
ARRUGA Pincés capsulaires	49
ARRUGA Porte-aiguilles	69
Articles divers	94 - 95
Aspiration et irrigation, Canules pour	80
Aspiration, Canules d'aspiration	74, 80
AXENFELD Curette à chalazion	18
AXENFELD Ecarteurs	11
AXENFELD Porte-aiguilles	70
AYER Pince à chalazion	50
BACKHAUS Pince à compresses	64
Balle en silicone	81

B

BANGERTER Blépharostat	4
BANGERTER Pince musculaire	59
BANGERTER Spatules	21
BANGERTER Spatules à iris	19
BARKAN Couteau à goniotomie	17
BARRAQUER (MODÈLE ORIGINALE) Micro porte-aiguilles	68
BARRAQUER Blépharostats	2
BARRAQUER Ciseaux à iridectomie	42, 43
BARRAQUER Micro porte-aiguilles	66, 68
BARRAQUER Pince à suture	56
BARRAQUER Pince pour saisir	61
BARRAQUER Pincés à cils	57
BARRAQUER Pincés à fixation	53
BARRAQUER Porte-lames et brise lames	72
BARRAQUER-CASTROVIEJO Spatule à cyclodialyse	20
BARRAQUER-FRANKFURT Blépharostat	2
BARRAQUER-KRATZ Blépharostat	2
BARRAQUER-KRATZ OOSTERHUIS Blépharostat	3
BARRAQUER-OOSTERHUIS Blépharostats	3
BARRAQUER-OOSTERHUIS-KRATZ Blépharostat	3
BARRAQUER-TROUTMAN Micro porte-aiguilles	67
BEARD-MELLINGER Blépharostats	6
BEER Pince à cils	57
BERKE Pince à ptosis	50
BEST Trépan	82
BEST Trépan kérateplastie	82 - 83
BEYER Pince emporte-pièces	91
BINKHORST Canule irrigatoire	79
BINKHORST Spatule	20
BISHOP-HARMON Pincés à iris	62
Bistouri, Manche de	15
Bistouris stériles, Lames de	15
Blépharostats	2
Boîte pour stérilisation	93
BONN Canules irrigatoire	79
BONN Ciseaux à strabisme	41
BONN Couteaux pour la sclère	15
BONN Crochet à iris	29
BONN Crochets à strabisme	30
BONN Pincés à iris	62
BONN Pincés à iris, striés fins	63
BOWMAN Aiguilles à discision	17
BOYNTON Porte-aiguilles	70
BRAUWEILER Canule irrigatoire	79
BRAUWEILER Couteaux à IOL	15
BRAUWEILER Manche pour canule d'aspiration	80

BRAUWEILER Manche pour canule d'aspiration TITAN-LINE	80
BREMEN Crochet pour manipuler IOL TITAN-LINE	29
Brise lames, Porte-lames et	72
Bulldog Clamps	63
BUNGE Culettes pour l'exentération	18
BURRATO Pince à cornée pour lasik	60

C

Canal lacrymal, Sondes pour le	84 - 85
Canule à enzyme	74
Canule à healon	74
Canule d'aspiration, Manches pour	80
Canule d'irrigation de cystotome	74
Canule pour capsule antérieure	79
Canules à air, Hydrodissection	77
Canules à voix lacrymales	74 - 76
Canules d'aspiration	74, 80
Canules irrigatoire	78 - 79
Canules oculaires	74 - 75
Canules pour irrigation et aspiration	80
Canules pour polissage de la capsule	73, 75
Canules rétrobulbaires	73
Capsulaires, Pincés	49
Capsule antérieure, Canule pour	79
Capsule, Canules pour polissage de la	73, 75
Capsule, Curettes de polissage de la	27
Capsule, Manipulateur du noyau et polisseur de la	27
CARTER Introduceur et support	95
CASTROVIEJO Blépharostats	7
CASTROVIEJO Ciseaux à cornée	38 - 39
CASTROVIEJO Ciseaux à iridectomie	42, 43
CASTROVIEJO Compas	92
Castroviejo Couteau lancéolair	16
CASTROVIEJO Micro porte-aiguilles	65
CASTROVIEJO Pince à fixer le droite supérieur	59
CASTROVIEJO Pincés à suture	56
CASTROVIEJO Pincés à suture	58
CASTROVIEJO Porte-aiguilles	69
CASTROVIEJO Porte-lames et brise lames	72
CASTROVIEJO Sonde pour le canal lacrymal	84
CASTROVIEJO Spatules à cyclodialyse	20
CASTROVIEJO-BARRAQUER Spatule à cyclodialyse	20
CASTROVIEJO-MICRO Micro porte-aiguilles	65
CASTROVIEJO-TROUTMAN Ciseaux à cornée	39
Cataracte, Anses à	25
CAUER Pince à chalazion	50
Cautére	87
Chalazion, Couteau à	16
Chalazion, Curettes à	18
Chalazion, Pincés à	50
Chambre antérieure, Pince pour la	49
CHAYET Marqueur pour kérateplastie	89
Chirurgicales, Pincés fines	51 - 52
Cils, Pincés à	57
Ciseaux à cornée	38 - 39
Ciseaux à énucléation	40
Ciseaux à iridectomie	42, 43
Ciseaux à strabisme	41
Ciseaux à sutures	40
Ciseaux à synéchies antérieurs	46
Ciseaux à ténotomie	44
Ciseaux à trabeculo	46
Ciseaux à vitreum	46
Ciseaux chirurgicaux fins	44
Ciseaux oculaires	45
Ciseaux-burin	94
Ciseaux-burin à corps étrangers	32
Ciseaux-burins et aiguilles à corps étrangers	33
Ciseaux-micro	34 - 37
CITELLI Pincés emporte-pièces	91
Clamps Bulldog	63
CLAYMAN Pincés à explantation	61
Clear-Cornea-Incision, Anneaux de fixation pour	12
Clear-Cornea-Incision, Couteaux de diamant pour	13
Clou pour la sclère	95

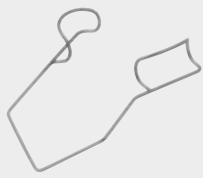

Index

COLIBRI (TROUTMAN) Pince à fixation	52
Colibri, Micro-pinces	54
Colibri, Pinces	54
Compas	92
Compresses, Pinces à	64
Conjonctivales, Pinces	54
COOK Blépharostats	5
Cornéale, Lasik protecteur	18
Cornéale, Lasik purificateur de la surface	18
Cornée, Ciseaux à	38 - 39
Cornée, Scarificateurs pour	15
Corps étranger, Aiguilles à	32
Corps étranger, Aiguilles et ciseaux-burins à	33
Corps étranger, Ciseaux-burin à	32
Corps étranger, Ciseaux-burins et aiguilles à	33
Corps étrangers, Gouge à	32
Corps étrangers, Instruments à	32 - 33
Corps étrangers, Pinces à cils pour	57
Couteau à chalazion	16
Couteau à discision	17
Couteau à goniotomie	17
Couteau de diamant pour paracentèse	13
Couteau de diamant pour paupières et dupuytren	13
Couteau pour keratoplastie	15
Couteau-spatule de diamant	13
Couteaux à IOL	15
Couteaux de diamant	13 - 14
Couteaux de diamant pour Clear-Cornea-Insicion	13
Couteaux de diamant pour kératotomie	14
Couteaux de diamant pour retina	14
Couteaux de diamant, Mesureur pour	14
Couteaux lancéolaires	16
Couteaux oculaires	15 - 17
Couteaux pour la sclère	15
Couteaux pour l'iris	17
Couteaux pour sato	16
Couteaux-spatule à membrane	25
CRANZ Douche oculaire	78
Crochet à iris e fendeur du noyau	27
Crochet à marqueur	88
Crochets à iris	29
Crochets à iris (plaies)	11
Crochets à plaies (iris)	11
Crochets à strabisme	30
Crochets musculaires	30
Crochets pour manipuler IOL	28 - 29
Crochets pour manipuler IOL TITAN-LINE	28 - 29
Curette pour l'enucléation	22
Curettes à chalazion	18
Curettes de polissage de la capsule	27
Curettes pour l'exentération	18
Cyclodialyse, Spatules à	20
Cystotome, Canule d'irrigation	74

D

D.-D.-KOCH Spatule pour phaco	20
DARDANNE Couteau pour sato	16
DARDANNE Pince à suture	56
DARDENNE Crochet à iris	29
DARDENNE Pince pour nucléus	55
DESMARRES Pincettes à chalazion	50
DESMARRES Releveurs de paupières	10
DIEFFENBACH Clamps Bulldog	63
Discision, Aiguilles à	17
Discision, Couteau à	17
Dissección, Pincettes fines pour	51
Divers articles	94 - 95
DIX Aiguille et ciseaux-burin à corps étrangers	33
DIX Aiguille et gouge à corps étrangers	33
DIX Ciseaux-burin et aiguille à corps étrangers	33
DIX Gouge et aiguille à corps étrangers	33
DODEN Pince pour implantation	60
DODICK-LUNTZ Poinçonneuse	90
Douche oculaire	78
DRAEGER Pince conjonctivale	54

Droite supérieur, Pincettes à fixer	59
DRYSDALE Manipulateur du noyau et polisseur de la capsule	27
Dupuytren et paupières, Couteau de diamant pour	13

E

Ecarteurs	11
Ecarteurs autostatiques	11
Élévateur	94
ELLIOT Trépans	82
ELLIS Ciseaux-burin à corps étrangers	32
ELSCHING Pincettes à fixer le droite supérieur	59
ELSCHING Spatule	20
ELSCHING Spatules à iris	19
ENGELKING-HESS Pince à iris	62
ENGELS Spatule à mesurer	92
Énucléation, Ciseaux à	40
Énucléation, Curette pour l'	22
Enzyme, Canule à	74
Éplacheurs de membrane	31, 47, 48
ESSEN Spatule	21
Exentération, Curettes pour l'	18
Explantation, Pince à	61

F

FECHNER Pince pour implantation	60
Fendeur du noyau et crochet à iris	27
Fendeur du noyau TITAN-LINE	26
Fendeurs du noyau	22, 26
FINK Marqueur	88
Fixation, Griffes à	53
Fixation, Pincettes à	52 - 53
FÖRSTER Pince conjonctivale	54
Fragment, Pincettes pour	55
FRANCESCHETTI Trépans kératoplastie	82 - 83
FRANKFURT Canule à air, Hydrodissection	77
FRANKFURT Crochet à iris	29
FRANKFURT Crochet pour manipuler IOL	28
FRANKFURT Spatules à iris	19
FRANKFURT-BARRAQUER Blépharostat	2
FRIEDMAN-LUER Pince-gouge	95
FRONIMPOULUS Marqueur	88

G

GASKIN Pincettes pour fragment	55
GASS Poinçonneuse pour glaucome	90
GIessen Releveur de paupières	10
GIessen Sonde pour le canal lacrymal	84
GIessen Spatule	21
GIRARD-SWAN Couteau pour l'iris	17
Glaucome, Poinçonneuses pour	90
GOLDSTEIN Ecarteur autostatique	11
Goniotomie, Couteau à	17
Gouge	94
Gouge à corps étrangers	32
Gouges et aiguilles à corps étrangers	33
GRADLE Pince à cils	57
GRAEFE (KAUFMANN) Pince conjonctivale	54
GRAEFE Ciseaux oculaires	45
GRAEFE Couteau pour l'iris	17
GRAEFE Crochets à strabisme	30
GRAEFE Kystitome	17
GRAEFE Pince à fixation	53
GRAEFE Pince chirurgicale	51 - 52
GRAEFE Sclérotome	17
GRIESHABER-JAEGER Couteaux lancéolaires	16
Griffe à fixation	53
GUTHRIE Crochets à iris (plaies)	11
GUTHRIE Crochets à plaies (iris)	11
GUYTON-LUNDSGAARD Sclérotome	17

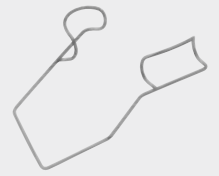

H

H.-R.-KOCH Anse	95
H.-R.-KOCH Canule pour aspiration	80
HAAB Couteau pour l'iris	17
HALSTED-MICRO Pincés hémostatiques	64
HAMBURG Crochet à strabisme	30
HAMBURG MOD. Couteau lancéolaire	16
HAMBURG Pince à iris	62
HAMBURG Sondes rétrogrades	86
HAMBURG Spatule orbitale	21
HAMBURG Trépans kératoplastie	82 - 83
HARMON-BISHOP Pincés à iris	62
HARMS Sondes à trabeculotomie	86
HARTMANN Pincés hémostatiques	64
HARTMANN Spéciculum pour nez	95
Healon, Canule à	74
HEBRA Curettes à chalazion	18
HEIDELBERG Pince à fixation	53
HEIDELBERG Pince à iris	62
HEIDELBERG Porte-aiguilles	70
HEIMANN Ciseaux à vitreum	46
HEIMANN Clou pour la sclère	95
HELVESTON Crochets musculaires	30
Hémostatiques, Pincés	64
HENRY Pince à cils	57
HESS-ENGELKING Pince à iris	62
HIRSCHMANN Spatule	22
HOFFER Marqueurs pour kératoplastie	88
HOPKINS-JOHN Clamps Bulldog	63
HOSPITAL-WILLS Cautére	87
Hydrodissection, Canules à air	77

I

Implantation, Pincés pour	60
Instruments à corps étrangers	32 - 33
Instruments pour lasik	18
Instruments pour mesurer	92
Introduceur et support	95
Introduceur pour le clou pour la sclère TITAN-LINE	95
IOL, Couteaux à	15
IOL, Crochets pour manipuler	28
IOL, TITAN-LINE Crochets pour manipuler	28 - 29
IOL's pliable, Pincés pour plier	61
Iridectomie, Ciseaux à	42, 43
Iris, Couteaux pour l'	17
Iris, Crochets à	29
Iris, Fendeur du noyau e crochet à	27
Iris, Pincés à	62
Iris, Pincés striés fines à	63
Iris, Spatules à	19
Irrigation et aspiration, Canules pour	80
Irrigation, Anses à lentilles avec	78
Irrigatoire, Canules	78

J

JACOBI Crochet à iris	29
JACOBI Crochets pour manipuler IOL	28
JACOBI Micro porte-aiguilles	67
JAEGER Plaque à paupières en métal	10
JAEGER-GRIESHABER Couteaux lancéolaires	16
JAMESON Crochet à strabisme	30
JESS Pince à fixation	52
JOHN-HOPKINS Clamps Bulldog	63
JÜNEMANN Sondes pour le canal lacrymal	84

K

KALT Porte-aiguilles	69
KAMANN Blépharostat	8
KATZIN Ciseaux kératoplastique	38
KAUFMANN (GRAEFE) Pince conjonctivale	54

KELLNAR Sondes rétrogrades	86
KELLY Poinçonneuse	90
KELMAN-MC PHERSON Pince pour fragment	55
Kératoplastie, Couteau pour	15
Kératoplastie, Marqueurs pour	88
Kératoplastie, Spatule pour	22
Kératoplastie, Trépans	82 - 83
Kératotomy, Couteaux de diamant pour	14
Kératotomy, Pince pour	52
KERRISON Pincés emporte-pièces	91
KERSHNER Blépharostats	7
KNAPP Couteau à discision	17
KNOLLE-SHEPARD Pince pour implantation PCL	60
KOCH Blépharostat	2
KOCH Pince capsulaire	49
KOCH Pince pour plier IOL's pliables	61
KOCH-D.-D. Spatule pour phaco	20
KOCH-H.-R. Anse	95
KOCH-H.-R. Canule pour aspiration	80
KRATZ-BARRAQUER-OOSTERHUIS Blépharostat	3
KRATZ-OOSTERHUIS-BARRAQUER Blépharostat	3
KREFELD (LESTER) Pince conjonctivale	54
KREISSIG Localisateur	31
KREMER Pince à fixation	52
KROLL-MORRIS Éplacheur de membrane	31
KUHNT Scarificateurs pour cornée	15
Kystitome	17

L

LAMBERT Pince à chalazion	50
Lames	72
Lames de bistouris, stériles	15
Lancéolaires	16
Lances	16
Lances-Phaco	16
LAQUA Localisateurs	31
Lasik protecteur cornéal	18
Lasik purificateur de la surface cornéale	18
Lasik, Instruments pour	18
Lasik, Pincés à cornée pour	60
LEMBERT Rugines-raspatoire	94
Lentille, Rotateur pour manipuler le noyau de	22
LESTER (KREFELD) Pince conjonctivale	54
LESTER Crochet pour manipuler IOL TITAN-LINE	29
LEYDHECKER Pince à fixer le droite supérieur	59
LIEBERMANN-TENNANT Blépharostats	7 - 8
LINDSTROM Marqueurs pour kératoplastie	89
Localisateurs	31
LORDAN Pince à chalazion	50
LUER-FRIEDMAN Pince-gouge	95
LUND Crochet à iris	29
LUNDSGAARD-GUYTON Sclérotome	17
LUNTZ-DODICK Poinçonneuse	90

M

MACKENSEN Sondes à trabeculotomie	86
Maillet	94
MAINZ Crochet pour manipuler IOL	28
MAINZ NEW MODEL Crochet pour manipuler IOL TITAN-LINE	28
MALBRAN Crochet à strabisme	30
Manche pour bistouri	15
Manches pour canule d'aspiration	80
Manipulateur du noyau et polisseur de la capsule	27
Marquer, Crochet à	88
Marqueur pour suture	88 - 89
Marqueurs	88 - 89
Marqueurs pour kératoplastie	88
MAUMENEE-PARK Blépharostat	8
MC PHERSON Pince à suture	56
MC PHERSON-KELMAN Pince pour fragment	55
MC PHERSON-WESTCOTT Ciseaux à ténotomy	38
MCINTYRE Canule pour capsule antérieure	79
MEAD Maillet	94

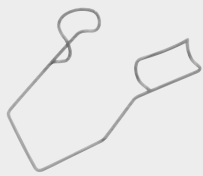

Index

MELLINGER Blépharostats	6
MELLINGER-BEARD Blépharostats	6
Membrane, Éplacheurs de	31, 47, 48
Membrane, Spatules à	23 - 25
MENDEZ Instrument pour mesurer	92
MENDEZ Marqueur pour kératoplastie	89
Mesurer, Spatule à	92
Mesureur pour couteaux de diamant	14
METZENBAUM Ciseaux à strabisme	41
MEYER-SCHWICKERATH Localisateur	31
MEYHÖFER Curettes à chalazion	18
Micro porte-aiguilles	65
MICRO-CASTROVIEJO Micro porte-aiguilles	65
Micro-ciseaux	34 - 37
MICRO-HALSTED Pincés hémostatiques	64
Micro-pincés Colibri	54
MIYOSHI Fendeur du noyau TITAN-LINE	26
MIYOSHI Fendeurs du noyau	26
MOD. HAMBURG Couteau lancéolaire	16
MOD. TÜBINGEN VANNAS Micro-ciseaux	34
MODEL NEW MAINZ Crochet pour manipuler IOL TITAN-LINE	28
MODELL SCHWEIZER Trépons kératoplastie	82
MORRIS-KROLL Éplacheur de membrane	31
MÜLLER Canules irrigatoire	78
MÜLLER Ecarteur autostatique	11
MUMM-SCHMIDT Trépons	82
MURDOCK Blépharostats	5
Musculaires, Crochets	30
Musculaires, Pincés	59

N

NAGAHARA Fendeur du noyau	26
NEUHANN Blépharostat	3
NEUHANN Crochet pour manipuler et fendre le noyau	22
NEUHANN Fendeur du noyau et crochet à iris	27
NEUHANN Fendeurs du noyau	26
NEUHANN Marqueur pour suture	88
NEUHANN Marqueurs pour kératoplastie	88
NEUHANN Pince pour implantation	60
NEUHANN Pince pour plier IOL's pliables	61
NEUHANN Rotateur pour manipuler le noyau de lentille	22
NEW MODEL MAINZ Crochet pour manipuler IOL TITAN-LINE	28
Noyau, Crochet à iris e fendeur du	27
Noyau, Crochet pour fendre le	22
Noyau, Crochet pour fendre le	22, 26
Noyau, Polisseur de la capsule et manipulateur du	27
NOYES Ciseaux à iridectomie	42, 43
NUGENT Pince à cornée pour lasik	60

O

Oculaire, Couteaux	15
Oculaire, Douche	78
Oculaires, Canules	74
Oculaires, Ciseaux	45
OOSTERHUIS-BARRAQUER Blépharostats	3
OOSTERHUIS-BARRAQUER-KRATZ Blépharostat	3
OOSTERHUIS-KRATZ-BARRAQUER Blépharostat	3
Orbitale, Spatules	21
OSHER Compas	92

P

Paracentèse, Couteau de diamant pour	13
PARK-MAUMENEE Blépharostat	8
PAUFIQUE Couteau pour keratoplastie	15
PAUFIQUE Pincés à suture	56
Paupières et dupuytren, Couteau de diamant pour	13
Paupières, Plaque à	10
Paupières, Releveurs de	10
Phaco, Spatules pour	20
Phaco-lances	16
Pince à ptosis	50

Pince clamps à suture	64
Pince pour écarter	55
Pince pour kératotomie	52
Pince pour la chambre antérieure	49
Pince-gouge	95
Pincés à chalazion	50
Pincés à cils	57
Pincés à cils pour corps étrangers	57
Pincés à compresses	64
Pincés à cornée pour lasik	60
Pincés à explantation	61
Pincés à fixation	52 - 53
Pincés à fixer le droite supérieur	59
Pincés à iris	62
Pincés à iris, striés fines	63
Pincés à suture	54
Pincés à suture	56, 58
Pincés à vitrectomie	47 - 48
Pincés capsulaires	49
Pincés Colibri	54
Pincés conjonctivales	54
Pincés emporte-pièces	91
Pincés fines chirurgicales	51 - 52
Pincés fines pour dissection	51
Pincés hémostatiques	64
Pincés musculaires	59
Pincés pour fragment	55
Pincés pour implantation	60
Pincés pour nucléus	55
Pincés pour plier IOL's pliables	61
Pincés pour saisir	61
Pincés-micro Colibri	54
Plaque à paupières	10
Poinçonneuse pour sclérale	90
Poinçonneuses	90
Poinçonneuses pour glaucome	90
Polisseur de la capsule et manipulateur du noyau	27
Porte-aiguilles	69 - 70
Porte-aiguilles micro	65
Porte-instruments pour stérilisation	81
Porte-lames et brise lames	72
Portes pour tampons absorbants	71
PRETORI Blépharostats	6
Protecteurs des yeux	89
Ptosis, Pince à	50

R

Règles	92
Releveurs de paupières	10
REMKY Pince à fixer le droite supérieur	59
REMKY Pince pour kératotomie	52
RENTSCH Canule irrigatoire	79
RENTSCH Crochet pour manipuler IOL TITAN-LINE	28
RENTSCH Curettes de polissage de la capsule	27
Retina, Couteaux de diamant pour	14
Rétrogrades, Sondes	86
Robinet	81
ROHRSCHEIDER Porte-aiguilles	70
ROLLET Ecarteur	11
Rotateur pour manipuler le noyau de lentille TITAN-LINE	22
Rugines-raspoir	94

S

Saisir, Pincés pour	61
Sato, Couteaux pour	16
SATTLER Pincés musculaires	59
SAUER Blépharostat	4
SAUER Pince à iris	62
SAUPE Pince à cils	57
SAUTER Spatules orbitale	21
SAUTTER Canule à air, Hydrodissection	77
Scarificateurs pour cornée	15
SCHÄDEL Pince à compresses	64



SCHIOETZ Tonomètre	92
SCHMIDT-MUMM Trépans	82
SCHOTT Blépharostats	9
SCHWARTZ Pince clamps à suture	64
SCHWEIZ Pince à iris	62
SCHWEIZER MODELL Trépans kératoplastie	82
Sclérale, Poinçonneuse pour	90
Sclère, Clou pour la	95
Sclère, Couteaux pour la	15
Sclère, Introducteur pour le clou pour la	95
Sclérotomes	17
SEBILEAU Elévateur	94
SHAAF Pince à cils pour corps étrangers	57
SHEPARD Pinces pour implantation	60
SHEPARD-KNOLLE Pince pour implantation	60
SICHEL Couteau pour l'iris	17
Silicone, Balle en	81
SIMCOE Canule pour irrigation et aspiration	80
SINSKEY Crochet à marqueur	88
SINSKEY Crochet pour manipuler IOL TITAN-LINE	28
SNELLEN Anse à cataracte	25
Sondes	86
Sondes à trabéculotomie	86
Sondes pour le canal lacrymal	84 - 85
Sondes rétrogrades	86
SPALECK Pince pour plier IOL's pliables	61
Spatule à mesurer	92
Spatule pour kératoplastie	22
Spatule-Couteaux à membrane	25
Spatules	20 - 22
Spatules à cyclodialyse	20
Spatules à iris	19
Spatules à membrane	23 - 25
Spatules orbitale	21
Spatules pour phaco	20
Spéculum pour nez	95
SPENCER Ciseaux à sutures	40
ST. MARTIN Pince à suture	58
Stérilisation, Boîte pour	93
STEVENS Ciseaux à ténotomie	44
STEVENS Pince conjonctivale	54
Strabisme, Crochets à	30
Strabisme, Ciseaux à	41
Support et introducteur	95
Suture, Marqueur pour	88 - 89
Suture, Pinces à	54
Suture, Pinces à	56
Suture, Pinces clamps à	64
Sutures, Ciseaux à	40
SUZUKI Crochet pour manipuler IOL	28
SWAN-GIRARD Couteau pour l'iris	17
Synéchies antérieurs, Ciseaux à	46

T

TAKEDA Blépharostat	2
Tampons absorbants	71
Tampons absorbants, Portes pour	71
TENNANT Pince à suture	56
TENNANT-LIEBERMANN Blépharostats	7 - 8
TENNER Pince pour implantation	60
Ténotomie, Ciseaux à	44
THORNTON Anneux de fixation	12
THORNTON Blépharostat	2
TITAN-LINE Crochets pour manipuler IOL	28 - 29
TITAN-LINE Fendeur du noyau	26
TITAN-LINE Introducteur pour le clou pour la sclère	95
TITAN-LINE Manche pour canule d'aspiration	80
TITAN-LINE Rotateur pour manipuler le noyau de lentille	22
TITAN-LINE Spatules à iris	19
TODD-WADDSWORTH Cautére	87
Tonomètre	92
Trabeculo, Ciseaux à	46
Trabéculotomie, Sondes à	86
Trépans	82 - 83
Trépans kératoplastie	82 - 83

TROUTMAN (COLIBRI) Pince à fixation	52
TROUTMAN Ciseaux à cornée	39
TROUTMAN Pince à fixer le droite supérieur	59
TROUTMAN Pince à suture	54
TROUTMAN Porte-lames et brise lames	72
TROUTMAN-BARRAQUER Micro porte-aiguilles	67
TROUTMAN-CASTROVIEJO Ciseaux à cornée	39
TÜBINGEN Canule à air, Hydrodissection	77
TÜBINGEN Pinces à suture	56

V

VANNAS Micro-ciseaux	34
VANNAS MOD. TÜBINGEN Micro-ciseaux	34
Vitrectomie, Pinces à	47 - 48
Vitreum, Ciseaux à	46
VOELCKER Fendeur du noyau	26
Voices lacrymales, Canules à voices	74 - 76
VON BARSEWISCH Pince pour la chambre antérieure	49

W

WADDSWORTH-TODD Cautére	87
WALSER Pinces à suture	58
WALSER Poinçonneuse pour sclère	90
WALTER Anneaux pour le bulbe	12
WALTER Ciseaux à ténotomie	44
WATZKE Pince pour écarter	55
WEBER Anses à cataracte	25
WECKER Ciseaux à iridectomie	42, 43
WECKER Spatules à iris TITAN-LINE	19
WEISS Blépharostat	4
WELLS Curette pour l'enucléation	22
WEST Ciseaux-burin	94
WEST Gouge	94
WESTCOTT Micro-ciseaux	35
WESTCOTT-MC PHERSON Ciseaux à ténotomie	38
WILDER Sondes pour le canal lacrymal	84
WILLS-HOSPITAL Cautére	87

Y

Yeux, Protecteurs des	89
-----------------------	----

Z

ZIRM Crochet pour manipuler IOL	29
ZIRM Fendeur du noyau	26
ZIRM Lasik protecteur cornéal	18
ZIRM Lasik purificateur de la surface cornéale	18
ZÜRICH Pinces à suture	54

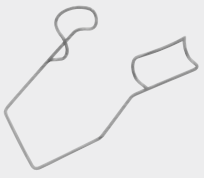

Index

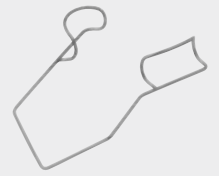

A

Accessori	81
Aghi e scalpelli per corpi estranei	33
Aghi e sgorbie per corpi estranei	33
Aghi per corpi estranei	32
Aghi taglienti	17
Ago per cataratta	17
Ago per sclera	95
AMON Spatola per phaco	20
Anatomiche per dissezione, fini, Pinze	51
ANEL Sonde per canale lacrimale	76
Anelli di fissaggio	12
Anelli di fissaggio per clear-cornea-incisione	12
Ansa	95
ARLT Cappio per cateratta	25
ARRUGA Pinze per capsula	49
ARRUGA Portaghi	69
Articoli vari	94 - 95
Aspirazione ed irrigazione, Cannule d'	80
Aspirazione, Cannule d'	74, 80
AXENFELD Curette per orzaiuolo	18
AXENFELD Divaricatori	11
AXENFELD Portaghi	70
AYER Pinza per chalazion	50

B

BACKHAUS Pinza fissatelo	64
BANGERTER Bloccopalpebra	4
BANGERTER Pinza muscolare	59
BANGERTER Spatole	21
BANGERTER Spatole per iride	19
BARKAN Bisturi goniometro	17
BARRAQUER (MODELO ORIGINALE) Micro portaghi	68
BARRAQUER Bloccopalpebra	2
BARRAQUER Forbici per iride	42, 43
BARRAQUER Micro portaghi	66, 68
BARRAQUER Pinza afferra / spezza lamette	72
BARRAQUER Pinza per sutura	56
BARRAQUER Pinza piega IOL	61
BARRAQUER Pinze di fissaggio	53
BARRAQUER Pinze per ciglia	57
BARRAQUER-CASTROVIEJO Spatola per ciclodialisi	20
BARRAQUER-FRANKFURT Bloccopalpebra	2
BARRAQUER-KRATZ Bloccopalpebra	2
BARRAQUER-KRATZ OOSTERHUIS Bloccopalpebra	3
BARRAQUER-OOSTERHUIS Bloccopalpebra	3
BARRAQUER-OOSTERHUIS-KRATZ Bloccopalpebra	3
BARRAQUER-TROUTMAN Micro portaghi	67
BEARD-MELLINGER Bloccopalpebra	6
BEER Pinza per ciglia	57
BERKE Pinza per ptosis	50
BEST Tre quarti	82
BEST Tre quarti cheratoplastica	82 - 83
BEYER Pinza per laminectomia	91
BINKHORST Cannula d'irrigazione	79
BINKHORST Spatola	20
BISHOP-HARMON Pinze per iride	62
Bisturi	17
Bisturi a lancia	16
Bisturi con lama a spatola di diamante	13
Bisturi goniometro	17
Bisturi in diamante	13 - 14
Bisturi in diamante per cheratomia	14
Bisturi in diamante per Clear-cornea-incisione	13
Bisturi in diamante per palpebra e dupuytren	13
Bisturi in diamante per paracentesi	13
Bisturi in diamante per retina	14
Bisturi in diamante, Calibro per	14
Bisturi per cheratoplastica	15
Bisturi per IOL	15
Bisturi per iride	17
Bisturi per occhio	15 - 17
Bisturi per orzaiuolo	16
Bisturi per sato	16

Bisturi per sclera	15
Bisturi sterili, Lame da	15
Bisturi, Manico da	15
Bloccopalpebra	2
BONN Bisturi per sclera	15
BONN Cannule d'irrigazione	79
BONN Forbici per strabismo	41
BONN Pinze per iride	62
BONN Pinze per iride, scanalatura delicata	63
BONN Uncini per strabismo	30
BONN Uncino per iride	29
BOWMAN Aghi taglienti	17
BOYNTON Portaghi	70
Brauweiler Bisturi per IOL	15
BRAUWEILER Cannula d'irrigazione	79
BRAUWEILER Manico per cannula d'aspirazione	80
BRAUWEILER Manico per cannula d'aspirazione TITAN-LINE	80
BREMEN Uncino per la manipolazione IOL TITAN-LINE	29
Bulldog Pinze	63
BUNGE Cucchiato d'estrazione	18
BURRATO Pinze corneali Lasik	60

C

Calibro per bisturi in diamante	14
Camera atneriore, Pinza per	49
Canale lacrimale, Sonde per	74 - 76
Canale lacrimale, Specilli per	84 - 85
Cannula d'aspirazione, Manico per	80
Cannula d'irrigazione	74
Cannula per capsula anteriore	79
Cannula per healon	74
Cannula retrobulbare	73
Cannule d'aspirazione	74, 80
Cannule d'irrigazione	78 - 79
Cannule d'irrigazione ed aspirazione	80
Cannule d'irrigazione per nucleo	78
Cannule oculari	74 - 75
Cannule per capsula lucidatrice	73, 75
Cannule per idrodissezione	77
Cappio per cateratta	25
Capsula anteriore, Cannula per	79
Capsula lucidatrice, Cannule per	73, 75
Capsula, Curette per la lucidatura della	27
Capsula, Pinza per	49
Capsula, Uncino per manipolazione nucleo e lucidatura della	27
CARTER Guida	95
CASTROVIEJO Bisturi lanceolato	16
CASTROVIEJO Bloccopalpebra	7
CASTROVIEJO Compasso	92
CASTROVIEJO Forbice per iride	42, 43
CASTROVIEJO Forbici per cornea	38 - 39
CASTROVIEJO Micro portaghi	65
CASTROVIEJO Pinza per retto superiore	59
CASTROVIEJO Pinze afferra / spezza lamette	72
CASTROVIEJO Pinze per sutura	56
CASTROVIEJO Pinze per sutura	58
CASTROVIEJO Portaghi	69
CASTROVIEJO Spatole per ciclodialisi	20
CASTROVIEJO Specille per canale lacrimale	84
CASTROVIEJO-BARRAQUER Spatola per ciclodialisi	20
CASTROVIEJO-MICRO Micro portaghi	65
CASTROVIEJO-TROUTMAN Forbici per cornea	39
Cateratta, Cappio per	25
CAUER Pinza per chalazion	50
Cauterio	87
Cestelli per sterilizzazione	93
Chalazion, Pinze per	50
CHAYET Marcatore corneale	89
Cheratomia, Bisturi in diamante per	14
Cheratoplastica, Bisturi per	15
Cheratoplastica, Pinza per	52
Cheratoplastica, Spatola per	22
Cheratoplastica, Tre quarti	82 - 83
Chirurgie, Pinze fini per	51
Ciclodialisi, Spatole per	20

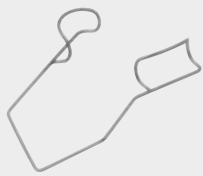

Indice

Ciglia, Pinze per	57
Cistotomo	17
Cistotomo irrigatore	74
CITELLI Pinze per laminectomia	91
CLAYMAN Pinza d'estrazione	61
Clear-cornea-incisione, Anelli di fissaggio per	12
Clear-cornea-incisione, Bisturi in diamante per	13
Clip vascolare	64
COLIBRI (TROUTMAN) Pinza di fissaggio	52
Colibri, Micro-pinze	54
Colibri, Pinze	54
Compasso	92
Congiuntiva, Pinze per	54
Contenitore in silicone	81
COOK Bloccopalpebra	5
Cornea, Forbici per	38 - 39
Cornea, Lasik per la pulizia superficiale della	18
Cornea, Lasik protettore della	18
Cornea, Raschietti per	15
Comeale, Marcatori	88
Corpi estranei, Aghi e scalpelli per	33
Corpi estranei, Aghi per	32
Corpi estranei, Scalpelli e aghi per	33
Corpi estranei, Scalpello per	32
Corpi estranei, Sgobia per	32
Corpi estranei, Strumentario per	32 - 33
Corpi estranei, Pinze per ciglia e	57
CRANZ Doccia oculare	78
Cucchiaino d'estrazione	18
Cucchiaino per enucleazione	22
Curette per la lucidatura della capsula	27
Curette per orzaiuolo	18

D

D.-D.-KOCH Spatola per phaco	20
DARDANNE Bisturi per sato	16
DARDANNE Pinza per sutura	56
DARDENNE Pinza per nucleo	55
DARDENNE Uncino per iride	29
DESMARRES Divaricatori per palpebra	10
DESMARRES Pinze per chalazion	50
DIEFFENBACH Pinze Bulldog	63
Dispositivo per rutorare il nucleo della lente TITAN-LINE	22
Divaricatori	11
Divaricatori autostatici	11
Divaricatori cutaneo (uncino per iride)	11
Divaricatori per iride (cutaneo)	11
Divaricatori per palpebra	10
DIX Ago e scalpello per corpi estranei	33
DIX Ago e sgorbia per corpi estranei	33
DIX Scalpello e ago corpi estranei	33
DIX Sgorbia e ago per corpi estranei	33
Doccia oculare	78
DODEN Pinza per trapianti	60
DODICK-LUNTZ Pinza	90
DRAEGER Pinza per congiuntiva	54
DRYSDALE Uncino per manipolazione nucleo e lucidatura della capsula	27
Dupuytren e palpebra, Bisturi in diamante per	13

E

Elevatore	94
ELLIOT Trequarti	82
ELLIS Scalpello per corpi estranei	32
ELSCHING Pinze per retto superiore	59
ELSCHING Spatola	20
ELSCHING Spatole per iride	19
Emostatiche, Pinze	64
ENGELKING-HESS Pinza per iride	62
ENGELS Spatola graduata	92
Enucleazione, Cucchiaino per	22
Enucleazione, Forbici per	40
ESSEN Spatola	21
Estrazione, Cucchiaino	18

Estrazione, Pinza d'	61
----------------------	----

F

FECHNER Pinza per trapianti	60
FINK Marcatore	88
Fissaggio, Pinze di	52 - 53
Fissaggio, Uncini di	53
Fissatelo, Pinze	64
Forbici delicate per chirurgia	44
Forbici di sinechia anteriore	46
Forbici micro	34 - 37
Forbici oculari	45
Forbici per cornea	38 - 39
Forbici per enucleazione	40
Forbici per iride	42, 43
Forbici per legature	40
Forbici per strabismo	41
Forbici per tenotomia	44
Forbici per trabeculo	46
Forbici per vitreo	46
FÖRSTER Pinza per congiuntiva	54
Frammenti, Pinze per	55
FRANCESCHETTI Trequarti cheratoplastica	82 - 83
FRANKFURT Cannula per idrodissezione	77
FRANKFURT Spatole per iride	19
FRANKFURT Uncino di posizione per IOL	28
FRANKFURT Uncino per iride	29
FRANKFURT-BARRAQUER Bloccopalpebra	2
FRIEDMAN-LUER Pinza per ossa	95
FRONIMOPOULUS Marcatore	88

G

GASKIN Pinzas per frammenti	55
GASS Pinza per glaucoma	90
GIESSEN Divaricatore per palpebra	10
GIESSEN Spatola	21
GIESSEN Specille per canale lacrimale	84
GIRARD-SWAN Bisturi per iride	17
Glaucoma, Pinze per glaucoma	90
GOLDSTEIN Divaricatore autostatico	11
Goniometro, Bisturi	17
GRADLE Pinza per ciglia	57
GRAEFE (KAUFMANN) Pinza per congiuntiva	54
GRAEFE Bisturi per iride	17
GRAEFE Cistotomo	17
GRAEFE Forbice oculare	45
GRAEFE Pinza chirurgica	51 - 52
GRAEFE Pinza di fissaggio	53
GRAEFE Sclerotomo	17
GRAEFE Uncini per strabismo	30
GRISHABER-JAEGER Bisturi a lancia	16
Guida	95
Guida per ago per sclera TITAN-LINE	95
GUTHRIE Divaricatori cutaneo (uncino per iride)	11
GUTHRIE Divaricatori per iride (cutaneo)	11
GUYTON-LUNDSGAARD Sclerotomo	17

H

H.-R.-KOCH Ansa	95
H.-R.-KOCH Cannula d'aspirazione	80
HAAB Bisturi per iride	17
HALSTED-MICRO Pinze emostatiche	64
HAMBURG MOD. Bisturi linceolato	16
HAMBURG Pinza per iride	62
HAMBURG Sonde retrograde	86
HAMBURG Spatula orbitale	21
HAMBURG Trequarti cheratoplastica	82 - 83
HAMBURG Uncino per strabismo	30
HARMON-BISHOP Pinze per iride	62
HARMS Sonde per trabeculo	86
HARTMANN Pinze emostatiche	64

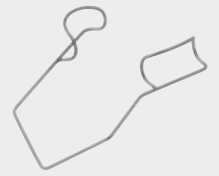

HARTMANN Speculo nasale	95
Healon, Cannula per	74
HEBRA Curette per orzaiuolo	18
HEIDELBERG Pinza di fissaggio	53
HEIDELBERG Pinza per iride	62
HEIDELBERG Portaghi	70
HEIMANN Ago per sclera	95
HEIMANN Forbici per vitreo	46
HELVESTON Uncini muscolare	30
HENRY Pinza per ciglia	57
HESS-ENGELKING Pinza per iride	62
HIRSCHMANN Spatola	22
HOFFER Marcatori corneale	88
HOPKINS-JOHN Pinze Bulldog	63
HOSPITAL-WILLS Cauterio	87

I

Iddrodissezione, Cannule per	77
IOL, Bisturi per	15
IOL, Pinze piega IOL	61
IOL, TITAN-LINE Uncini di posizione per	28 - 29
IOL, TITAN-LINE Uncino per la manipolazione	29
IOL, Uncini di posizione per	28
IOL, Uncini per la manipolazione	29
Iride, Bisturi per	17
Iride, Forbici per	42, 43
Iride, Pinze anatomiche per	63
Iride, Pinze per	62
Iride, Separatore del nucleo e uncino per l'	27
Iride, Spatole per	19
Iride, Uncini per	29
Irrigatore, Cistotomo	74
Irrigazione ed aspirazione, Cannule d'	80
Irrigazione, Cannula d'	74
Irrigazione, Cannule d'	78

J

JACOBI Micro portaghi	67
JACOBI Uncini di posizione per IOL	28
JACOBI Uncino per iride	29
JAEGER Placca per palpebra in metallo	10
JAEGER-GRISHABER Bisturi a lancia	16
JAMESON Uncino per strabismo	30
JESS Pinza di fissaggio	52
JOHN-HOPKINS Pinze Bulldog	63
JÜNEMANN Specilli per canale lacrimale	84

K

KALT Portaghi	69
KAMANN Bloccopalpebra	8
KATZIN Forbici per cheratoplastica	38
KAUFMANN (GRAEFE) Pinza per congiuntiva	54
KELLNAR Sonde retrograde	86
KELLY Pinza	90
KELMAN-MC PHERSON Pinza per frammenti	55
KERRISON Pinze per laminectomia	91
KERSHNER Bloccopalpebra	7
KNAPP Bisturi	17
KNOLLE-SHEPARD Pinza per trapianti HCL	60
KOCH Bloccopalpebra	2
KOCH Pinza per capsula	49
KOCH Pinza piega IOL	61
KOCH-D.-D. Spatola per phaco	20
KOCH-H.-R. Ansa	95
KOCH-H.-R. Cannula d'aspirazione	80
KRATZ-BARRAQUER-OOSTERHUIS Bloccopalpebra	3
KRATZ-OOSTERHUIS-BARRAQUER Bloccopalpebra	3
KREFELD (LESTER) Pinza per congiuntiva	54
KREISSIG Periostotomo per membrana	31
KREMER Pinza di fissaggio	52
KROLL-MORRIS Membrana Peeler	31

KUHNT Raschietti per cornea	15
------------------------------------	----

L

LAMBERT Pinza per chalazion	50
Lame da bisturi, sterili	15
Lamette	72
Lancia, Bisturi a	16
Lancie	16
Lancie phaco	16
LAQUA Periostotomo per membrana	31
Lasik per la pulizia superficiale della cornea	18
Lasik protettore della cornea	18
Lasik, Pinze corneali	60
Lasik, Strumenti per	18
Legature, Forbici per	40
LEMBERT Periostotomo	94
Lente, Dispositivo per rutorare il nucleo della	22
LESTER (KREFELD) Pinza per congiuntiva	54
LESTER Uncino per la manipolazione IOL TITAN-LINE	29
LEYHECKER Pinza per retto superiore	59
LIEBERMANN-TENNANT Bloccopalpebra	7 - 8
LINDSTROM Marcatori corneale	89
Localizzatori	31
LORDAN Pinza per chalazion	50
Lucidatura della capsula e uncino per manipolazione nucleo	27
LUER-FRIEDMAN Pinza per ossa	95
LUND Uncino per iride	29
LUNDSGAARD-GUYTON Sclerotomo	17
LUNTZ-DODICK Pinza	90

M

MACKENSEN Sonde per trabeculo	86
MAINZ NEW MODEL Uncino di posizione per IOL TITAN-LINE	28
MAINZ Uncino di posizione per IOL	28
MALBRAN Uncino per strabismo	30
Manico da bisturi	15
Manico per cannula d'aspirazione	80
Manico per tamponi triangolari	71
Marcatore per sutura	88 - 89
Marcatore, Uncino	88
Marcatori	88 - 89
Marcatori corneale	88
Martello	94
MAUMENEE-PARK Bloccopalpebra	8
MC PHERSON Pinza per sutura	56
MC PHERSON-KELMAN Pinza per frammenti	55
MC PHERSON-WESTCOTT Forbice per tenotomia	38
MCINTYRE Cannula per capsula anteriore	79
MEAD Martello	94
MELLINGER Bloccopalpebra	6
MELLINGER-BEARD Bloccopalpebra	6
Membrana, Periostotomi per	31, 47, 48
Membrana, Spatole per	23 - 25
MENDEZ Marcatore corneale	89
MENDEZ Strumento di misurazione	92
METZENBAUM Forbici per strabismo	41
MEYER-SCHWICKERATH Periostotomo per membrana	31
MEYHÖFER Curette per orzaiuolo	18
Micro portaghi	65
MICRO-CASTROVIEJO Micro portaghi	65
Microforbici	34 - 37
MICRO-HALSTED Pinze emostatiche	64
Micropinze colibri	54
MIYOSHI Nucleodivisore TITAN-LINE	26
MIYOSHI Nucleodivisori	26
MOD. HAMBURG Bisturi lanceolato	16
MOD. TÜBINGEN VANNAS Microforbici	34
MODEL NEW MAINZ Uncino di posizione per IOL TITAN-LINE	28
MODELL SCHWEIZER Tre quarti cheratoplastica	82
MORRIS-KROLL Membrana Peeler	31
MÜLLER Cannule d'irrigazione	78
MÜLLER Divaricatore autostatico	11
MUMM-SCHMIDT Tre quarti	82

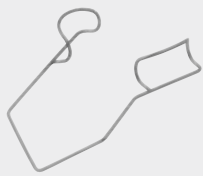

Indice

MURDOCK Bloccopalpebra	5
Muscolare, Pinze	59
Muscolare, Uncini	30

N

NAGAHARA Nucleodivisore	26
NEUHANN Nucleodivisori	26
NEUHANN Bloccopalpebra	3
NEUHANN Dispositivo di rotazione del centrolente e nucleodivisore	22
NEUHANN Dispositivo per ruotare il nucleo della lente	22
NEUHANN Marcatore per sutura	88
NEUHANN Marcatori corneale	88
NEUHANN Pinza per trapianti	60
NEUHANN Pinza piega IOL	61
NEUHANN Separatore del nucleo e uncino per l'iride	27
NEW MODEL MAINZ Uncino di posizione per IOL TITAN-LINE	28
NOYES Forbici per iride	42, 43
Nucleo, Cannule d'irrigazione per	78
Nucleo, Lucidatura della capsula e uncino per manipolazione	27
Nucleo, Uncino per l'iride e separatore del	27
Nucleodivisore TITAN-LINE	26
Nucleodivisori	22, 26
NUGENT Pinze corneali Lasik	60

O

Occhio, Bisturi per	15
Oculare, Doccia	78
Oculari, Cannule	74
Oculari, Forbici	45
Oculari, Protettori	89
OOSTERHUIS-BARRAQUER Bloccopalpebra	3
OOSTERHUIS-BARRAQUER-KRATZ Bloccopalpebra	3
OOSTERHUIS-KRATZ-BARRAQUER Bloccopalpebra	3
Orbitale, Spatole	21
Orzaiuolo, Bisturi per	16
Orzaiuolo, Curette per	18
OSHER Compasso	92

P

Palpebra e dupuytren, Bisutri in diamante per	13
Palpebra, Placca per	10
Palpera, Divaricatori per	10
Paracentesi, Bisturi in diamante per	13
PARK-MAUMENEE Bloccopalpebra	8
PAUFIQUE Bisturi per cheratoplastica	15
PAUFIQUE Pinze per sutura	56
Periostotomi per membrana	31, 47, 48
Periostotomo	94
Phaco lancia	16
Phaco, Spatole per	20
Pinza d'estrazione	61
Pinza di diffusione	55
Pinza per camera anteriore	49
Pinza per cheratoplastica	52
Pinza per ossa	95
Pinza per ptosis	50
Pinze	90
Pinze afferra / spezza lamette	72
Pinze anatomiche per dissezione, fini	51
Pinze Bulldog	63
Pinze colibri	54
Pinze corneali Lasik	60
Pinze di fissaggio	52 - 53
Pinze emostatiche	64
Pinze fini per chirurgia	51
Pinze fissatelo	64
Pinze micro colibri	54
Pinze muscolari	59
Pinze per capsula	49
Pinze per chalazion	50
Pinze per ciglia	57

Pinze per ciglia e corpi estranei	57
Pinze per congiuntiva	54
Pinze per frammenti	55
Pinze per glaucoma	90
Pinze per iride	62
Pinze per iride, scanalatura delicata	63
Pinze per laminectomia	91
Pinze per nucleo	55
Pinze per retto superiore	59
Pinze per sutura	54
Pinze per sutura	56, 58
Pinze per trapianti	60
Pinze per vitrectomia	47 - 48
Pinze piega IOL	61
Pinze piega IOL	61
Placca per palpebra	10
Portaghi	69 - 70
Portaghi micro	65
PRETORI Bloccopalpebra	6
Protettori oculari	89
Ptosis, Pinza per	50
Punzone per sclera	90

R

Raschiotti per cornea	15
REMKY Pinza per cheratoplastica	52
REMKY Pinza per retto superiore	59
RENTSCH Cannula d'irrigazione	79
RENTSCH Curette per la lucidatura della capsula	27
RENTSCH Uncino di posizione per IOL TITAN-LINE	28
Retina, Bisturi in diamante per	14
Retrograde, Sonde	86
Retto superiore, Pinze per	59
Righe	92
ROHRSCHEIDER Portaghi	70
ROLLET Divaricatore	11
Rubinetto	81

S

Sato, Bisturi per	16
SATTLER Pinze muscolari	59
SAUER Bloccopalpebra	4
SAUER Pinza per iride	62
SAUPE Pinza per ciglia	57
SAUTER Spatule orbitale	21
SAUTTER Cannula per idrodissezione	77
Scalpellini e aghi per corpi estranei	33
Scalpello	94
Scalpello per corpi estranei	32
SCHÄDEL Pinza fissatelo	64
SCHIOETZ Tonometro	92
SCHMIDT-MUMM Trequarti	82
SCHOTT Bloccopalpebra	9
SCHWARTZ Clip vascolare	64
SCHWEIZ Pinza per iride	62
SCHWEIZER MODELL Trequarti cheratoplastica	82
Sclera, Ago per	95
Sclera, Bisutri per	15
Sclera, Guida per ago per	95
Sclera, Punzone per	90
Sclerotomi	17
SEBILEAU Elevatore	94
Separatore del nucleo e uncino per l'iride	27
Sgorbia	94
Sgorbia per corpi estranei	32
Sgrobie e aghi per corpi estranei	33
SHAAF Pinza per ciglia e corpi estranei	57
SHEPARD Pinze per trapianti	60
SHEPARD-KNOLLE Pinza per trapianti	60
SICHEL Bisturi per iride	17
Silicone, Contenitore in	81
SIMCOE Cannula d'irrigazione et aspirazione	80
Sinechia anteriore, Forbici di	46

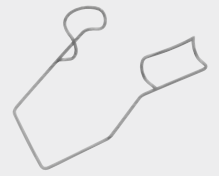

SINSKEY Uncino di posizione per IOL TITAN-LINE	28
SINSKEY Uncino marcatore	88
SNELLEN Cappio per cateratta	25
Sonde	86
Sonde per canale lacrimale	74 - 76
Sonde per trabeculo	86
Sonde retrograde	86
SPALECK Pinza piega IOL	61
Spatola graduata	92
Spatola per Cheratoplastica	22
Spatole	20 - 22
Spatole orbitale	21
Spatole per ciclodialisi	20
Spatole per iride	19
Spatole per membrana	23 - 25
Spatole per phaco	20
Specilli per canale lacrimale	84 - 85
Speculo nasale	95
SPENCER Forbici per legature	40
Spezza lametta / Pinze afferra	72
ST. MARTIN Pinza per sutura	58
Sterilizzazione, Cestelli per	93
STEVENS Forbici per tenotomia	44
STEVENS Pinza per congiuntiva	54
Strabismo, Forbici per	41
Strabismo, Uncini per	30
Strumentario per corpi estranei	32 - 33
Strumenti per lasik	18
Strumenti per misurare	92
Supporto per sterilizzazione	81
Sutura, Marcatore per	88 - 89
Sutura, Pinze per	54
Sutura, Pinze per	56
SUZUKI Uncino di posizione per IOL	28
SWAN-GIRARD Bisturi per iride	17

T

TAKEDA Bloccapalpebra	2
Tamponi triangolari	71
Tamponi triangolari, Manico per	71
TENNANT Pinza per sutura	56
TENNANT-LIEBERMANN Bloccapalpebra	7 - 8
TENNER Pinza per trapianti	60
Tenotomia, Forbici per	44
THORNTON Anelli di fissaggio	12
THORNTON Bloccapalpebra	2
TITAN-LINE Dispositivo per roturare il nucleo della lente	22
TITAN-LINE Guida per ago per sclera	95
TITAN-LINE Manico per cannula d'aspirazione	80
TITAN-LINE Nucleodivisore	26
TITAN-LINE Spatole per iride	19
TITAN-LINE Uncini di posizione per IOL	28 - 29
TITAN-LINE Uncino per la manipolazione IOL	29
TODD-WADDSWORTH Cauterio	87
Tonometro	92
Trabeculo, Forbici per	46
Trabeculo, Sonder per	86
Trapianti, Pinze per	60
Trequarti	82 - 83
Trequarti cheratoplastica	82 - 83
TROUTMAN (COLIBRI) Pinza di fissaggio	52
TROUTMAN Forbici per cornea	39
TROUTMAN Pinza per retto superiore	59
TROUTMAN Pinza per sutura	54
TROUTMAN Pinze afferra / spezza lamette	72
TROUTMAN-BARRAQUER Micro portaghi	67
TROUTMAN-CASTROVIEJO Forbici per cornea	39
TÜBINGEN Cannula per idrodisezione	77
TÜBINGEN Pinze per sutura	56

U

Uncini di fissaggio	53
Uncini di posizione per IOL	28 - 29

Uncini di posizione per IOL TITAN-LINE	28 - 29
Uncini muscolare	30
Uncini per iride	29
Uncini per la manipolazione IOL	29
Uncini per strabismo	30
Uncino marcatore	88
Uncino per la manipolazione IOL TITAN-LINE	29
Uncino per l'iride e separatore del nucleo	27
Uncino per manipolazione nucleo e lucidatura della capsula	27

V

VANNAS Microforbici	34
VANNAS MOD. TÜBINGEN Microforbici	34
Vari articoli	94 - 95
Vascolare, Clip	64
Vitrectomia, Pinze per	47 - 48
Vitreo, Forbici per	46
VOELCKER Nucleodivisore	26
VON BARSEWISCH Pinza per camera anteriore	49

W

WADDSWORTH-TODD Cauterio	87
WALSER Pinze per sutura	58
WALSER Punzone per sclera	90
WALTER Anelli per bulbo oculare	12
WALTER Forbice per tenotomia	44
WATZKE Pinza di diffusione	55
WEBER Cappio per cateratta	25
WECKER Forbici per iride	42, 43
WECKER Spatole per iride TITAN-LINE	19
WEISS Bloccapalpebra	4
WELLS Cucchiaino per enucleazione	22
WEST Scalpello	94
WEST Sgorbia	94
WESTCOTT Microforbici	35
WESTCOTT-MC PHERSON Forbice per tenotomia	38
WILDER Specilli per canale lacrimale	84
WILLS-HOSPITAL Cauterio	87

Z

ZIRM Lasik per la pulizia superficiale della cornea	18
ZIRM Lasik protettore della cornea	18
ZIRM Nucleodivisore	26
ZIRM Uncino per la manipolazione IOL	29
ZÜRICH Pinze per sutura	54



Indice

Nummernverzeichnis

Index of Numbers

Índice de números de referencias

Index des numéros de références

Indice dei codici

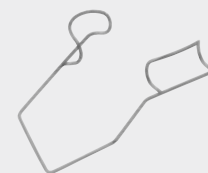

Kat.- Nr.	Seite	Kat.- Nr.	Seite	Kat.- Nr.	Seite	Kat.- Nr.	Seite	Kat.- Nr.	Seite
Cat. No.	Page	Cat. No.	Page	Cat. No.	Page	Cat. No.	Page	Cat. No.	Page
Núm. Ref.	Página	Núm. Ref.	Página	Núm. Ref.	Página	Núm. Ref.	Página	Núm. Ref.	Página
No. Réf.	Page	No. Réf.	Page	No. Réf.	Page	No. Réf.	Page	No. Réf.	Page
No. Cat.	Pagina	No. Cat.	Pagina	No. Cat.	Pagina	No. Cat.	Pagina	No. Cat.	Pagina
04		09-0968	57	60-0207	4	60-0609	13	60-0918	18
04-1010	15			60-0214	5	60-0610	13	60-0920	89
04-1011	15	18		60-0215	5	60-0611	13	60-0925	18
04-1057	15	18-0161	92	60-0216	5	60-0612	13	60-0928	18
		18-0162	92	60-0217	5	60-0613	13	60-0929	18
05		18-0164	92	60-0220	4	60-0614	13	60-0930	18
05-0112	40			60-0230	4	60-0616	13	60-0931	18
05-0117	40	21		60-0235	3	60-0617	13	60-0932	18
05-0308	44	21-0155	11	60-0237	3	60-0618	13	60-0935	18
05-0309	44	21-0156	11	60-0241	9	60-0619	13	60-0937	18
05-0310	44			60-0242	9	60-0620	17	60-0939	18
05-0311	44	45		60-0245	9	60-0622	16	60-0944	18
05-0314	44	45-0628	95	60-0246	9	60-0623	14	60-0966	88
05-0315	44	45-0790	91	60-0250	3	60-0624	14	60-0967	88
05-0320	44	45-0791	91	60-0252	3	60-0631	17	60-0970	88
05-0321	44	45-0792	91	60-0255	2	60-0651	17	60-0971	88
05-0326	45			60-0257	3	60-0662	15	60-0972	88
05-0328	45	47		60-0260	3	60-0663	15	60-0973	88
		47-0115	94	60-0265	3	60-0665	17	60-0974	88
06				60-0267	3	60-0667	17	60-0975	88
06-0010	63	48		60-0280	8	60-0670	17	60-0976	88
06-0011	63	48-0118	94	60-0306	11	60-0675	17	60-0977	88
06-0022	63			60-0311	11	60-0677	16	60-0978	88
06-0023	63	50		60-0460	31	60-0680	17	60-0979	88
06-0050	64	50-0621	64	60-0462	31	60-0681	17	60-0980	88
06-0051	64			60-0464	31	60-0682	16	60-0981	88
06-0054	64	60		60-0492	16	60-0684	16	60-0990	89
06-0055	64	60-0109	2	60-0496	16	60-0686	17	60-0991	89
06-0090	64	60-0111	2	60-0510	16	60-0688	16	60-1000	25
06-0091	64	60-0115	2	60-0533	29	60-0695	17	60-1002	25
06-0094	64	60-0118	2	60-0534	29	60-0742	31	60-1013	25
06-0095	64	60-0119	2	60-0537	26	60-0743	31	60-1014	25
		60-0122	5	60-0540	29	60-0745	26	60-1040	27
07		60-0123	5	60-0542	29	60-0766	15	60-1041	27
07-0100	64	60-0124	2	60-0543	26	60-0772	15	60-1055	22
07-0139	64	60-0125	2	60-0544	26	60-0778	15	60-1066	18
07-0709	93	60-0126	2	60-0545	29	60-0779	15	60-1068	18
07-0719	93	60-0129	5	60-0549	26	60-0786	16	60-1100	28
07-0920	81	60-0130	5	60-0556	29	60-0799	31	60-1102	28
07-2709	93	60-0131	2	60-0557	29	60-0800	12	60-1103	28
07-2719	93	60-0137	2	60-0558	29	60-0801	12	60-1105	28
07-2760	81	60-0142	6	60-0562	22	60-0802	12	60-1106	28
		60-0143	6	60-0565	15	60-0810	46	60-1107	28
08		60-0152	8	60-0566	15	60-0811	46	60-1108	28
08-0035	69	60-0160	7	60-0567	15	60-0813	46	60-1109	28
08-0036	69	60-0161	7	60-0568	15	60-0815	46	60-1110	30
08-0840	40	60-0162	7	60-0572	20	60-0820	95	60-1111	30
08-0844	40	60-0168	7	60-0573	20	60-0821	95	60-1112	30
		60-0169	8	60-0586	17	60-0855	33	60-1113	30
		60-0175	2	60-0590	27	60-0862	33	60-1114	30
09		60-0176	7	60-0596	26	60-0866	33	60-1117	30
09-0010	51	60-0177	7	60-0597	26	60-0867	33	60-1120	30
09-0016	63	60-0178	6	60-0598	26	60-0877	32	60-1150	86
09-0020	51	60-0180	6	60-0600	14	60-0892	32	60-1151	86
09-0026	51	60-0184	6	60-0601	14	60-0895	32	60-1152	86
09-0071	51	60-0190	6	60-0602	14	60-0896	32	60-1153	86
09-0072	51	60-0202	4	60-0604	13	60-0908	88	60-1170	30
09-0073	51	60-0203	4	60-0606	14	60-0910	89	60-1171	30
09-0080	51	60-0204	4	60-0607	14	60-0914	89	60-1173	30
09-0081	51	60-0206	4	60-0608	13	60-0917	18	60-1185	30
09-0351	52								

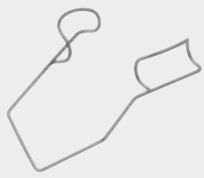

Nummernverzeichnis

Index of Numbers

Indice de números de referencias

Index des numéros de références

Indice dei codici

Kat.-Nr.	Seite	Kat.-Nr.	Seite	Kat.-Nr.	Seite	Kat.-Nr.	Seite	Kat.-Nr.	Seite
Cat. No.	Page	Cat. No.	Page	Cat. No.	Page	Cat. No.	Page	Cat. No.	Page
Núm. Ref.	Página	Núm. Ref.	Página	Núm. Ref.	Página	Núm. Ref.	Página	Núm. Ref.	Página
No. Réf.	Page	No. Réf.	Page	No. Réf.	Page	No. Réf.	Page	No. Réf.	Page
No. Cat.	Pagina	No. Cat.	Pagina	No. Cat.	Pagina	No. Cat.	Pagina	No. Cat.	Pagina
60-1186	30	60-1480	19	62-0237	55	62-0849	56	62-2217	78
60-1190	30	60-1481	19	62-0239	55	62-0853	56	62-2223	77
60-1191	30	60-1482	19	62-0241	55	62-0860	56	62-2227	74
60-1192	30	60-1483	19	62-0243	63	62-0864	58	62-2229	73
60-1199	10	60-1485	19	62-0244	62	62-0907	54	62-2232	80
60-1200	10	60-1486	19	62-0245	63	62-0908	52	62-2235	73
60-1201	10	60-1487	19	62-0246	62	62-0921	54	62-2236	73
60-1202	10	60-1488	20	62-0247	63	62-0922	54	62-2237	73
60-1203	10	60-1490	73	62-0248	62	62-0940	56	62-2240	80
60-1208	10	60-1493	19	62-0250	54	62-1030	60	62-2242	79
60-1220	11	60-1495	21	62-0256	62	62-1070	55	62-2245	78
60-1221	11	60-1496	21	62-0258	62	62-1075	55	62-2246	78
60-1229	53	60-1518	77	62-0266	62	62-1120	48	62-2247	78
60-1230	53	60-1521	77	62-0291	63	62-1122	48	62-2250	75
60-1252	12	60-1565	49	62-0293	63	62-1124	48	62-2280	80
60-1253	12	60-1705	21	62-0296	62	62-1126	48	62-2290	78
60-1262	10	60-1706	21	62-0310	62	62-1130	47	62-2304	75
60-1280	12	60-1710	23	62-0335	62	62-1132	47	62-2305	73
60-1285	12	60-1712	23	62-0362	54	62-1133	47	62-2309	79
60-1286	12	60-1713	23	62-0380	71	62-1135	47	62-2311	76
60-1287	12	60-1715	24	62-0382	71	62-1137	47	62-2312	76
60-1288	12	60-1717	23	62-0390	71	62-1138	48	62-2313	76
60-1289	12	60-1718	23	62-0418	53	62-1139	48	62-2314	76
60-1290	12	60-1720	24	62-0464	53	62-1141	48	62-2324	76
60-1307	22	60-1721	24	62-0465	53	62-1143	48	62-2325	76
60-1312	31	60-1723	24	62-0466	59	62-1220	57	62-2327	75
60-1323	10	60-1725	24	62-0467	59	62-1420	57	62-2328	75
60-1332	27	60-1727	25	62-0470	59	62-1430	57	62-2340	74
60-1334	31	60-1729	25	62-0473	59	62-1435	57	62-2341	74
60-1336	27	60-1735	22	62-0475	52	62-1445	57	62-2345	73
60-1340	88	60-1736	22	62-0476	52	62-1455	57	62-2350	77
60-1343	88	60-1745	22	62-0477	59	62-1460	57	62-2351	77
60-1347	88	60-1765	92	62-0498	59	62-1560	49	62-2377	80
60-1377	31	60-1770	92	62-0505	53	62-1640	49	62-2378	80
60-1386	20	60-1780	72	62-0507	52	62-1645	49	62-2550	81
60-1402	20	60-1791	72	62-0520	54	62-1692	60	62-2551	81
60-1405	19	60-1793	72	62-0561	62	62-1693	60	62-2552	81
60-1406	19	60-1794	72	62-0571	52	62-1694	60	62-2555	81
60-1418	19	60-1795	72	62-0573	52	62-1696	60	62-2590	81
60-1419	19	60-1797	72	62-0710	58	62-1697	60	62-2800	50
60-1420	20	60-2220	95	62-0711	58	62-1699	60	62-2805	50
60-1421	20	60-2224	95	62-0735	54	62-1720	55	62-2810	50
60-1428	21	60-2225	95	62-0736	54	62-1737	49	62-2811	50
60-1429	20	60-2250	90	62-0749	58	62-1740	49	62-2812	50
60-1430	21	60-2254	90	62-0750	58	62-1743	49	62-2852	50
60-1431	21	60-2256	90	62-0751	58	62-1745	49	62-2855	50
60-1432	21	60-2314	16	62-0752	58	62-1746	49	62-3255	59
60-1445	87	60-2315	16	62-0763	58	62-1838	61	62-3256	59
60-1447	19	60-2316	16	62-0770	58	62-1841	60	62-3275	59
60-1448	19	60-2317	16	62-0771	58	62-2050	61	62-3281	50
60-1450	87	60-2318	16	62-0772	58	62-2051	61	62-3703	49
60-1451	87			62-0805	56	62-2057	61	62-3706	66
60-1452	87	62		62-0808	56	62-2058	61	62-3707	66
60-1453	87	62-0165	54	62-0810	56	62-2060	61	62-3718	66
60-1454	87	62-0201	54	62-0820	56	62-2062	61	62-3719	66
60-1455	87	62-0202	54	62-0823	56	62-2065	61	62-3732	66
60-1465	21	62-0212	60	62-0832	56	62-2206	79	62-3733	66
60-1466	21	62-0224	62	62-0837	56	62-2207	79	62-3734	65
60-1469	22	62-0230	62	62-0841	61	62-2213	79	62-3735	65
60-1477	74	62-0231	62	62-0848	56	62-2215	79	62-3736	65

Nummernverzeichnis

Index of Numbers

Índice de números de referencias

Index des numéros de références

Indice dei codici

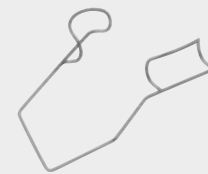

Kat.- Nr.	Seite	Kat.- Nr.	Seite	Kat.- Nr.	Seite	Kat.- Nr.	Seite	Kat.- Nr.	Seite
Cat. No.	Page	Cat. No.	Page	Cat. No.	Page	Cat. No.	Page	Cat. No.	Page
Núm. Ref.	Página	Núm. Ref.	Página	Núm. Ref.	Página	Núm. Ref.	Página	Núm. Ref.	Página
No. Réf.	Page	No. Réf.	Page	No. Réf.	Page	No. Réf.	Page	No. Réf.	Page
No. Cat.	Pagina	No. Cat.	Pagina	No. Cat.	Pagina	No. Cat.	Pagina	No. Cat.	Pagina
62-3739	65	63-0044	83	63-0850	43	63-1580	82	63-2711	91
62-3740	65	63-0045	83	63-0851	43	63-1581	82	63-2720	91
62-3741	65	63-0046	83	63-0852	43	63-1582	82	63-2730	90
62-3742	65	63-0047	83	63-0860	39	63-1583	82	63-2854	89
62-3743	65	63-0050	45	63-0900	44	63-1584	82	63-2855	89
62-3744	65	63-0051	45	63-0906	45	63-1585	82	63-2900	94
62-3745	65	63-0060	83	63-0907	45	63-1586	82	63-2905	94
62-3750	69	63-0061	83	63-1000	39	63-1587	82	63-2972	11
62-3752	69	63-0062	83	63-1003	38	63-1588	82	63-2973	11
62-3755	66	63-0063	83	63-1019	46	63-1589	82	63-2976	11
62-3756	66	63-0064	83	63-1020	46	63-1590	82		
62-3760	66	63-0065	83	63-1030	39	63-1800	92	68	
62-3761	66	63-0066	83	63-1031	39	63-1801	92	68-1214	94
62-3762	67	63-0067	83	63-1046	39	63-1880	92		
62-3763	67	63-0068	83	63-1047	39	63-2105	84	70	
62-3764	67	63-0069	83	63-1055	39	63-2107	84	70-0130	95
62-3765	67	63-0070	83	63-1056	39	63-2108	84		
62-3768	66	63-0080	82	63-1070	39	63-2109	84		
62-3769	66	63-0081	82	63-1071	37	63-2110	84		
62-3778	66	63-0082	82	63-1170	38	63-2111	84		
62-3779	66	63-0083	82	63-1171	38	63-2112	84		
62-3785	68	63-0084	82	63-1300	35	63-2115	84		
62-3786	68	63-0090	82	63-1302	38	63-2116	84		
62-3789	68	63-0091	82	63-1330	35	63-2117	84		
62-3798	68	63-0092	82	63-1337	36	63-2120	84		
62-3799	68	63-0093	82	63-1338	36	63-2200	85		
62-3820	70	63-0094	82	63-1342	36	63-2201	85		
62-3824	70	63-0095	82	63-1344	36	63-2202	85		
62-3830	69	63-0096	82	63-1346	36	63-2203	85		
62-3831	69	63-0097	82	63-1347	36	63-2204	85		
62-3837	70	63-0098	82	63-1400	34	63-2205	85		
62-3845	70	63-0200	41	63-1401	34	63-2220	85		
62-3870	67	63-0201	41	63-1402	34	63-2221	85		
62-3871	67	63-0202	41	63-1403	34	63-2222	85		
62-3872	67	63-0210	41	63-1406	34	63-2223	85		
62-3873	67	63-0211	41	63-1407	34	63-2224	85		
		63-0335	45	63-1408	34	63-2225	85		
63		63-0360	35	63-1430	35	63-2230	85		
63-0000	83	63-0402	41	63-1431	35	63-2231	85		
63-0001	83	63-0403	41	63-1432	35	63-2233	85		
63-0002	83	63-0420	44	63-1433	37	63-2235	85		
63-0003	83	63-0421	44	63-1434	37	63-2237	85		
63-0004	83	63-0430	44	63-1439	37	63-2239	85		
63-0005	83	63-0431	44	63-1540	82	63-2240	85		
63-0006	83	63-0512	40	63-1542	82	63-2241	85		
63-0007	83	63-0513	40	63-1544	82	63-2243	85		
63-0010	45	63-0530	46	63-1546	82	63-2245	85		
63-0011	45	63-0531	46	63-1548	82	63-2247	85		
63-0030	83	63-0720	43	63-1561	82	63-2249	85		
63-0031	83	63-0721	43	63-1562	82	63-2305	86		
63-0032	83	63-0722	43	63-1563	82	63-2306	86		
63-0033	83	63-0800	43	63-1564	82	63-2307	86		
63-0034	83	63-0824	42	63-1566	82	63-2308	86		
63-0035	83	63-0825	42	63-1567	82	63-2310	80		
63-0036	83	63-0826	42	63-1569	82	63-2377	74		
63-0037	83	63-0827	42	63-1570	82	63-2391	74		
63-0040	83	63-0829	42	63-1572	82	63-2392	74		
63-0041	83	63-0830	42	63-1574	82	63-2393	74		
63-0042	83	63-0831	42	63-1576	82	63-2405	92		
63-0043	83	63-0832	42	63-1578	82	63-2710	91		



Notizen

Notes

Notas

Notes

Note